

Subject to change without notice.

Return of Products Under Warranty

Please contact our Service Team before returning a defective device. Ship the cleaned device to the address you have been given. If the device has been in contact with process fluids, it must be decontaminated/disinfected before shipment. In that case, please attach a corresponding certificate, for the health and safety of our service personnel.

Disposal

Please observe the applicable local or national regulations concerning the disposal of "waste electrical and electronic equipment".

Knick

Elektronische Messgeräte GmbH & Co. KG

Beuckestraße 22

14163 Berlin

Germany

Phone: +49 30 80191-0

Fax: +49 30 80191-200

Web: www.knick.de

Email: info@knick.de

Table of Contents

Safety Information	5
Intended Use.....	7
Registered Trademarks.....	7
Provided Documentation	8
Overview of Stratos Eco 2405 Cond	9
Assembly	10
Package Contents.....	10
Mounting Plan.....	11
Pipe Mounting, Panel Mounting.....	12
Installation and Connection.....	14
Installation Instructions	14
Terminal Assignments	14
Wiring Examples	16
Sensor Connection Using VP Cables	20
Protective Wiring of Relay Outputs	22
User Interface and Display	24
Operation: Keypad	26
Safety Functions	27
Sensocheck, Sensoface Sensor Monitoring.....	27
GainCheck Device Self-Test.....	27
Automatic Device Self-Test	27
Hold Mode	28
Configuration	30
Menu Structure of Configuration	31
Overview of Configuration Steps	32
Output 1	34
Output 2	46
Temperature Compensation	52
Alarm Settings	54

Table of Contents

Limit Function.....	56
Controlling a Rinsing Probe.....	58
Connecting a Rinsing System	59
Parameters.....	60
Factory Settings of Parameters	60
Parameters – Individual Settings.....	62
Calibration	64
Calibration by Entry of Cell Constant.....	66
Calibration with Calibration Solution	68
Product Calibration	70
Temp Probe Adjustment	72
Measurement	72
Diagnostics Functions	73
Error Messages (Error Codes)	75
Operating States.....	77
Sensoface	78
Appendix.....	81
Product Line and Accessories	81
Specifications.....	82
Calibration Solutions.....	88
Concentration Curves	90
Safe Operation.....	96
Index	98
Passcodes	103

Safety information –

Be sure to read and observe the following instructions!

The device has been manufactured using state of the art technology and it complies with applicable safety regulations.

When operating the device, certain conditions may nevertheless lead to danger for the operator or damage to the device.

CAUTION!

Commissioning must be carried out by trained experts.

Whenever it is likely that protection has been impaired, the device shall be made inoperative and secured against unintended operation.

The protection is likely to be impaired if, for example:

- the device shows visible damage
- the device fails to perform the intended measurements
- after prolonged storage at temperatures above 70°C / 158 °F
- after severe transport stresses

Before recommissioning the device, a professional routine test in accordance with EN 61010-1 must be performed. This test should be carried out at the manufacturer's factory.

CAUTION!

Before commissioning, make sure that the transmitter may be connected with the other equipment.

Intended Use

Stratos Eco 2405 Cond is used for measurement of electrical conductivity and temperature in liquids. Fields of application are: biotechnology, chemical industry, environment, food processing, water/waste-water treatment.

The sturdy molded enclosure can be fixed into a control panel or mounted on a wall or at a post.

The protective hood provides additional protection against direct weather exposure and mechanical damage.

The device can be used with all 2- and 4-electrode sensors. It provides two current outputs (for transmission of measured value and temperature, for example), two contacts, and a universal power supply 24 ... 230 V AC/DC, AC: 45 ... 65 Hz.

Registered Trademarks

The following names are registered trademarks. For practical reasons they are shown without trademark symbol in this manual.

Stratos®

Sensocheck®

Sensoface®

GainCheck®

Provided Documentation

Safety Instructions

In official EU languages and others.

Quickstart Guides

In German, English, French, Russian, Finnish, Swedish, Spanish, Portuguese, and Chinese.

- Installation and Commissioning
- Operation
- Menu structure
- Calibration
- Error messages and recommended actions

Test Report 2.2

according to EN 10204

Overview of Stratos Eco 2405 Cond

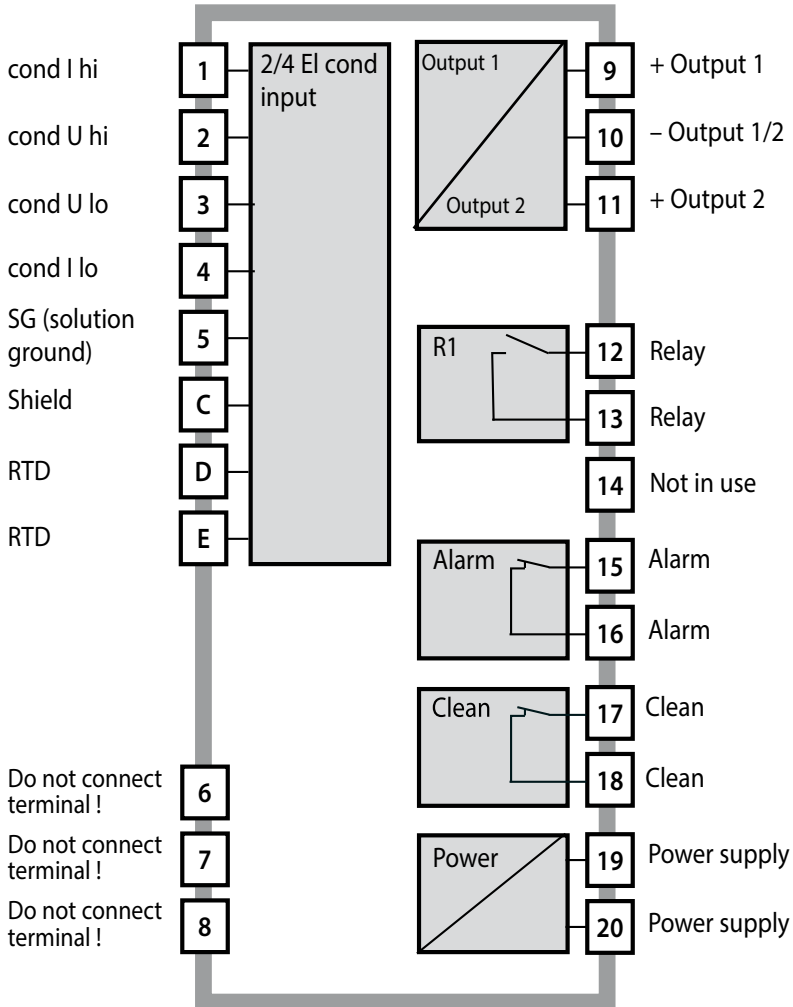

Assembly

Package Contents

Check the shipment for transport damage and completeness.
The package should contain:

- Front unit
- Rear unit
- Bag containing small parts
- Documentation
- Passcode sticker

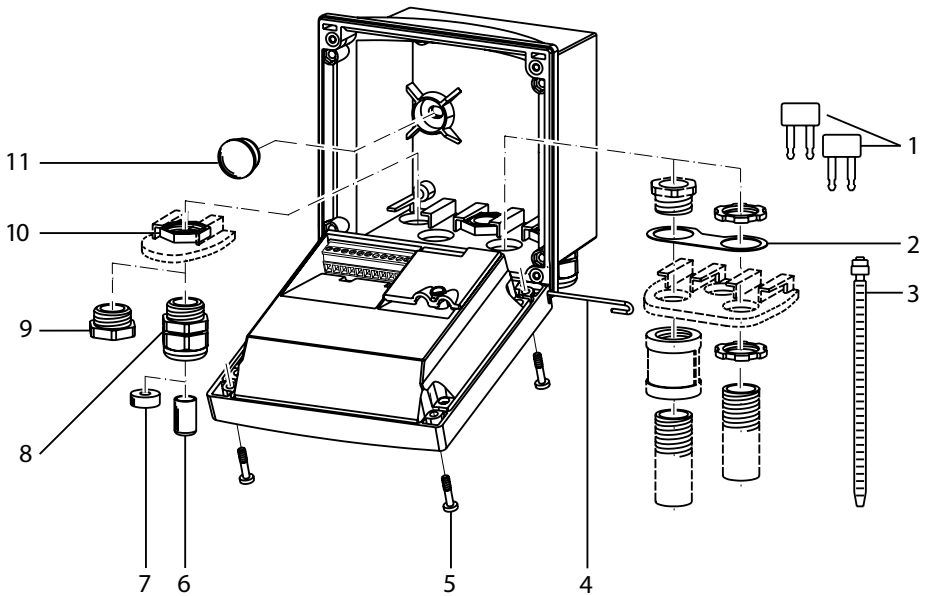

- | | |
|---|---|
| 1 Jumper (2 x) | 6 Sealing insert (1 x) |
| 2 Washer (1 x), for conduit mounting:
Place washer between enclosure and nut | 7 Rubber reducer (1 x) |
| 3 Cable tie (3 x) | 8 Cable gland (3 x) |
| 4 Hinge pin (1 x), insertable from either side | 9 Filler plug (3 x) |
| 5 Enclosure screw (4 x) | 10 Hexagon nut (5 x) |
| | 11 Sealing plug (2 x), for sealing in case of wall mounting |

Fig.: Assembling the enclosure

Mounting Plan

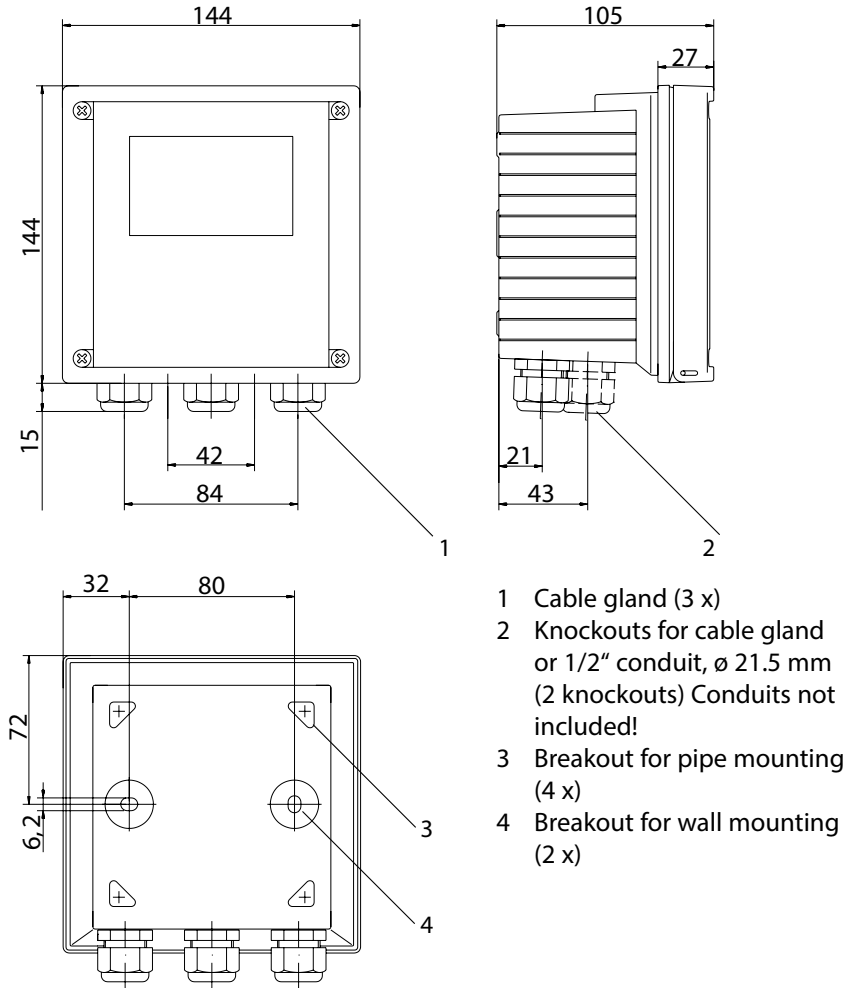
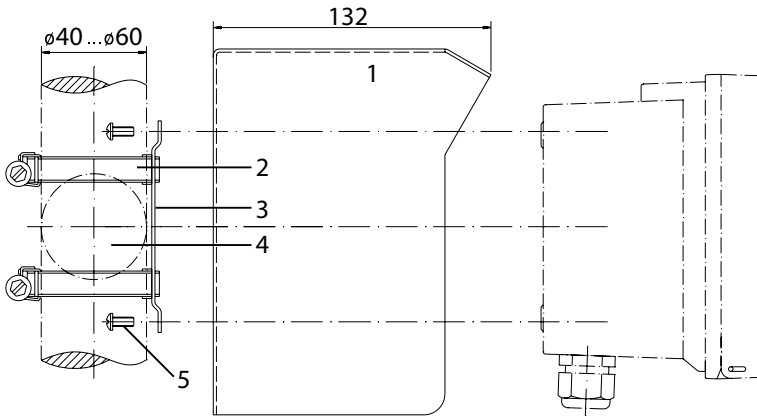

Fig.: Mounting plan (All dimensions in mm!)

Pipe Mounting, Panel Mounting



- 1 ZU 0276 protective hood (if required)
- 2 Hose clamp with worm gear drive to DIN 3017 (2 x)
- 3 Pipe-mount plate (1 x)
- 4 For vertical or horizontal posts or pipes
- 5 Self-tapping screw (4 x)

Fig.: ZU 0274 pipe-mount kit (All dimensions in mm!)

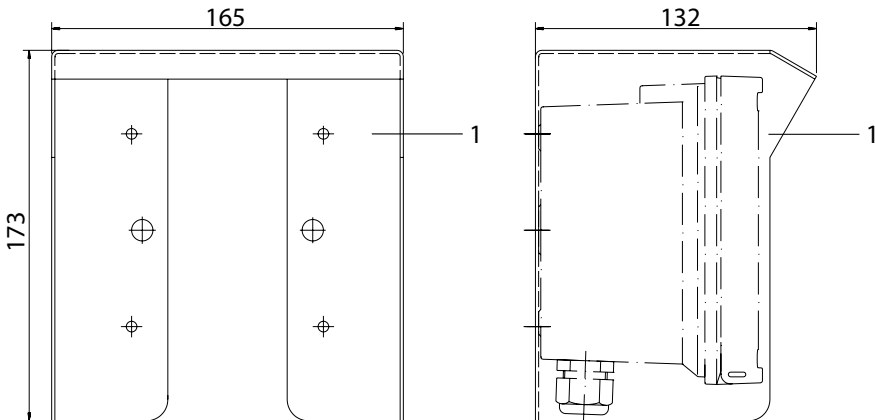
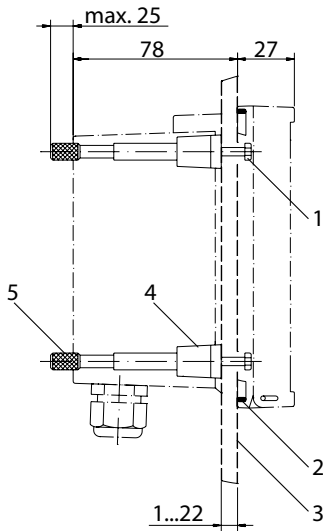

Fig.: ZU 0276 protective hood for wall and pipe mounting
(All dimensions in mm!)



- 1 Screw (4 x)
- 2 Gasket (1 x)
- 3 Control panel
- 4 Span piece (4 x)
- 5 Threaded sleeve (4 x)

Panel cut-out
138 x 138 mm (DIN 43700)

Fig.: ZU 0275 panel-mount kit (All dimensions in mm!)

Installation and Connection

Installation Instructions

CAUTION!

- Installation of the Stratos must be carried out by trained experts in accordance with this instruction manual and as per applicable local and national codes.
- Be sure to observe the technical specifications and input ratings during installation.
- Be sure not to notch the conductor when stripping the insulation.
- Before connecting the device to the power supply, make sure that its voltage lies within the range 20.5 ... 253 V AC/DC.
- All parameters must be set by a system administrator prior to commissioning.

The terminals are suitable for single wires and flexible leads up to 2.5 mm² (AWG 14).

Terminal Assignments

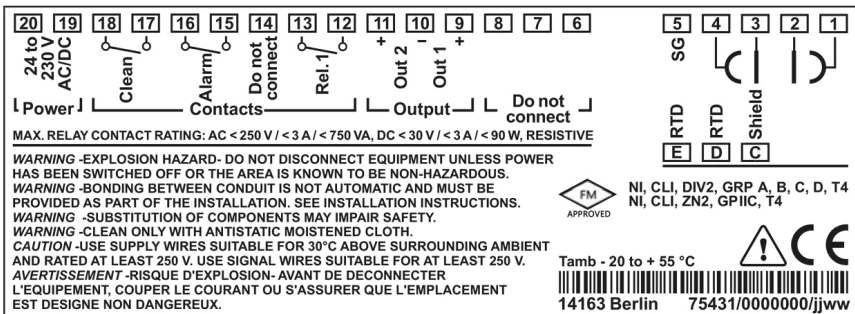
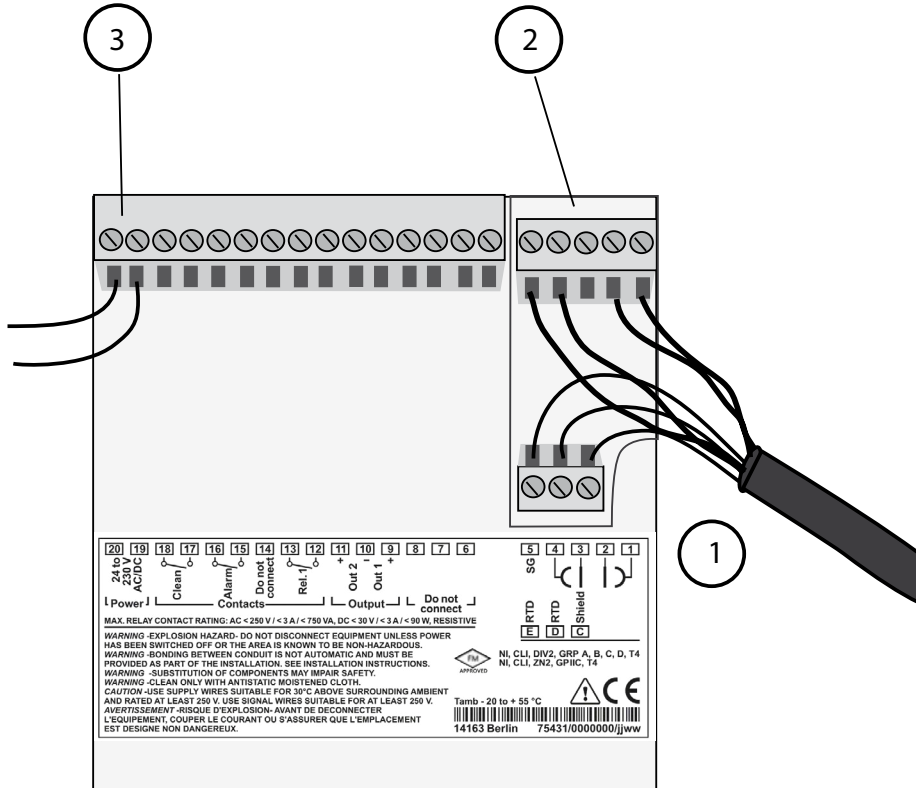

Fig.: Stratos Eco 2405 Cond terminal assignments



- 1 Terminals for temperature probe and outer shield
- 2 Terminals for sensor
- 3 Terminals for power supply

Fig.: Information on installation, rear side of device

Division 2 Wiring



The connections to the device must be installed in accordance with the National Electric Code (ANSI NFPA 70) Division 2 hazardous (classified) location non-incendive wiring techniques.

Wiring Examples

Cond measurement with 4-electrode sensor

Any 4-electrode sensors with cell constants from 0.0050 cm^{-1} to 19.9999 cm^{-1} , with or without temperature detector, can be connected, e.g. SE600, SE603.

Stratos Eco 2405 Cond

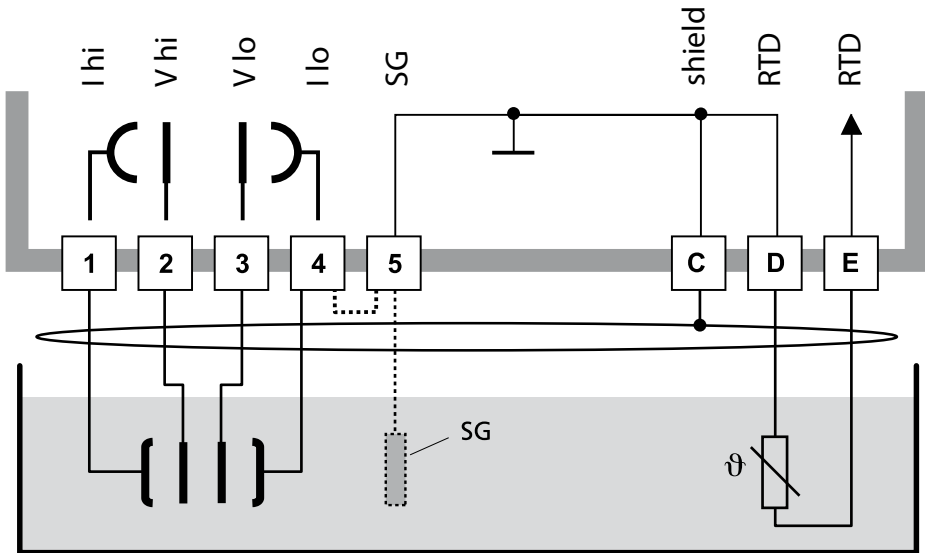

CAUTION!

Place jumper across terminals 4 and 5!

When using a sensor with Solution Ground connection (SG) or a separate SG connection, the jumper is not required!

Terminal	1	2	3	4	5	C	D	E	Cell constant
SE600	GY	PK	BU	RD	BN	YE/GN	WH/GN	YE+GN	$0.14...0.38 \text{ cm}^{-1}$
SE603	GY	PK	BU	RD	*	YE/GN	WH/GN	YE+GN	$0.14...0.38 \text{ cm}^{-1}$

* Connect external SG electrode (or tank wall) to terminal 5!

Cond measurement with 2-electrode sensor (coaxial electrodes)

Any 2-electrode sensors with cell constants from 0.0050 cm^{-1} to 19.9999 cm^{-1} , with or without temperature detector, can be connected, e.g. SE610.

Stratos Eco 2405 Cond

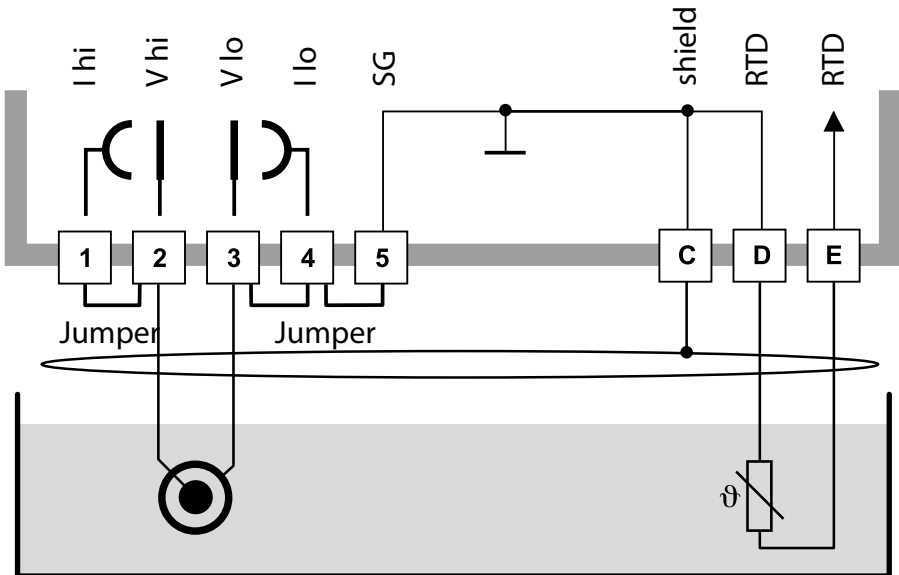

CAUTION!

Place jumpers:

- across terminals 1 and 2
- across terminals 3 and 4
- across terminals 4 and 5

Terminal	2 (jumper 1-2)	3 (jumper 3-4-5)	D	E	C	Cell constant
SE610	BN	WH	GN	YE	BK (shield)	0.1 cm^{-1}

Wiring Examples

Cond measurement with SE604 2-electrode sensor (coaxial electrodes)

Connection using cable ZU 0645 (3 m), ZU 0569 (5 m), ZU 0570 (10 m), ZU 0589 (15 m), ZU 0590 (20 m), or ZU 0660 (30 m)

Stratos Eco 2405 Cond

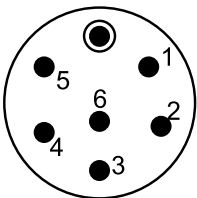
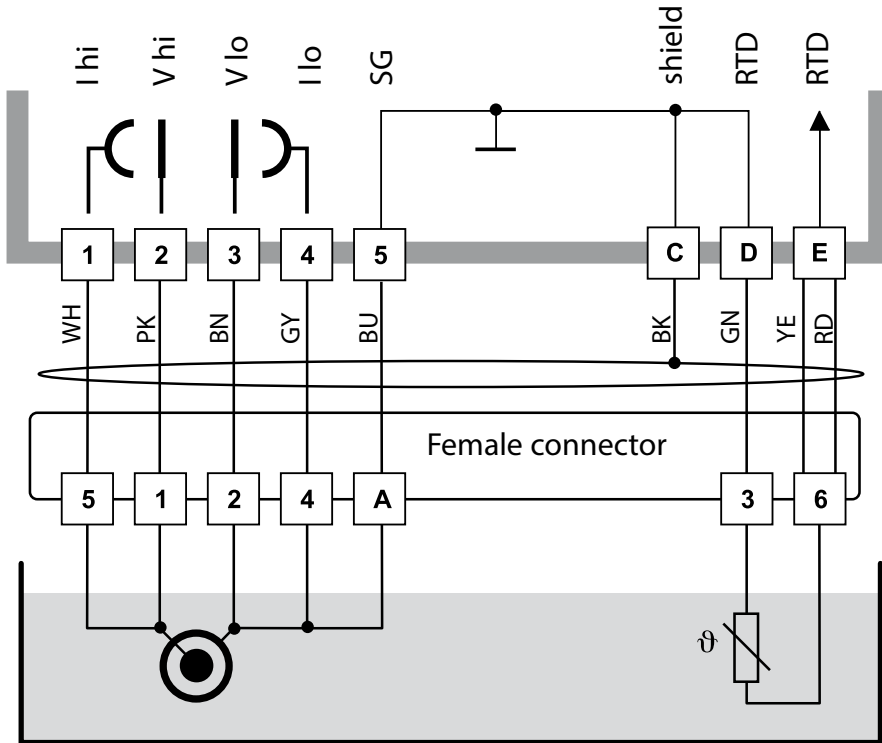

Sensor cap

Cond measurement with SE630 2-electrode sensor (formerly ZU 0071)

Connection using included GDM connector with 5-m cable

Stratos Eco 2405 Cond

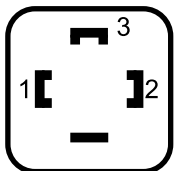
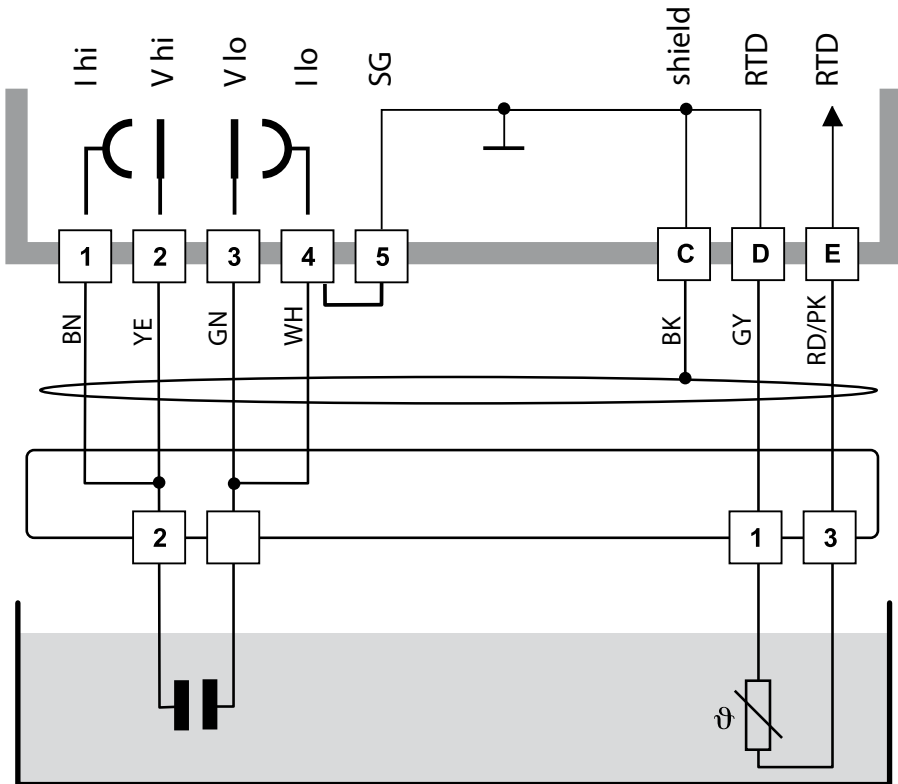

GDM connector

Wiring Examples

Sensor Connection Using VP Cables

Connection diagrams for connecting conductivity sensors using VP cables (e.g. SE620) are provided on request.

Any 2- or 4-electrode sensors with cell constants from 0.0050 cm^{-1} to 19.9999 cm^{-1} , with or without temperature detector, can be connected.

Protective Wiring of Relay Outputs

Protective Wiring of Relay Contacts

Relay contacts are subjected to electrical erosion. Especially with inductive and capacitive loads, the service life of the contacts will be reduced. For suppression of sparks and arcing, components such as RC combinations, nonlinear resistors, series resistors and diodes should be used.

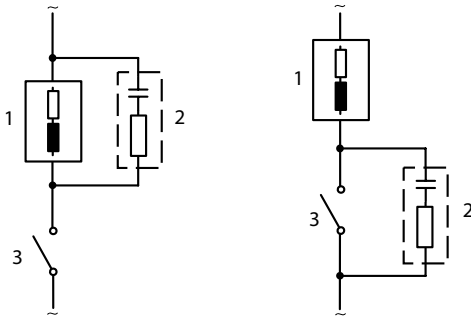

AC applications with inductive load

- 1 Load
- 2 RC combination, e.g. RIFA PMR 209
Typical RC combinations for 230 V AC:
Capacitor 0.1 μF / 630 V Resistor 100 ohms / 1 W
- 3 Contact

Typical Protective Wiring Measures

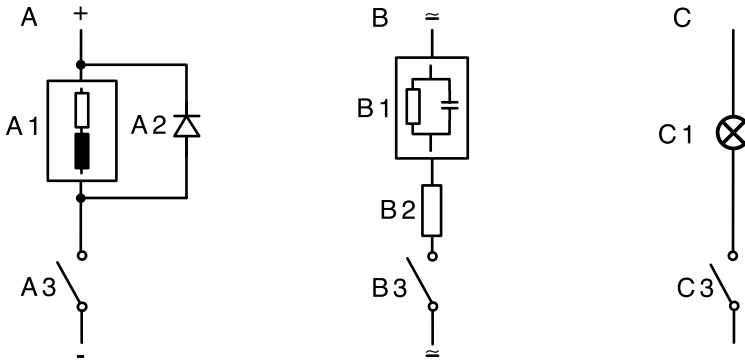

A: DC application with inductive load

B: AC/DC applications with capacitive load

C: Connection of incandescent lamps

A1 Inductive load

A2 Free-wheeling diode, e.g. 1N4007 (Observe polarity)

A3 Contact

B1 Capacitive load

B2 Resistor, e.g. 8Ω / 1 W at 24 V / 0.3 A

B3 Contact

C1 Incandescent lamp, max 60 W / 230 V, 30 W / 115 V

C3 Contact

WARNING!

Make sure that the maximum ratings of the relay contacts are not exceeded even during switching!

User Interface and Display

User Interface

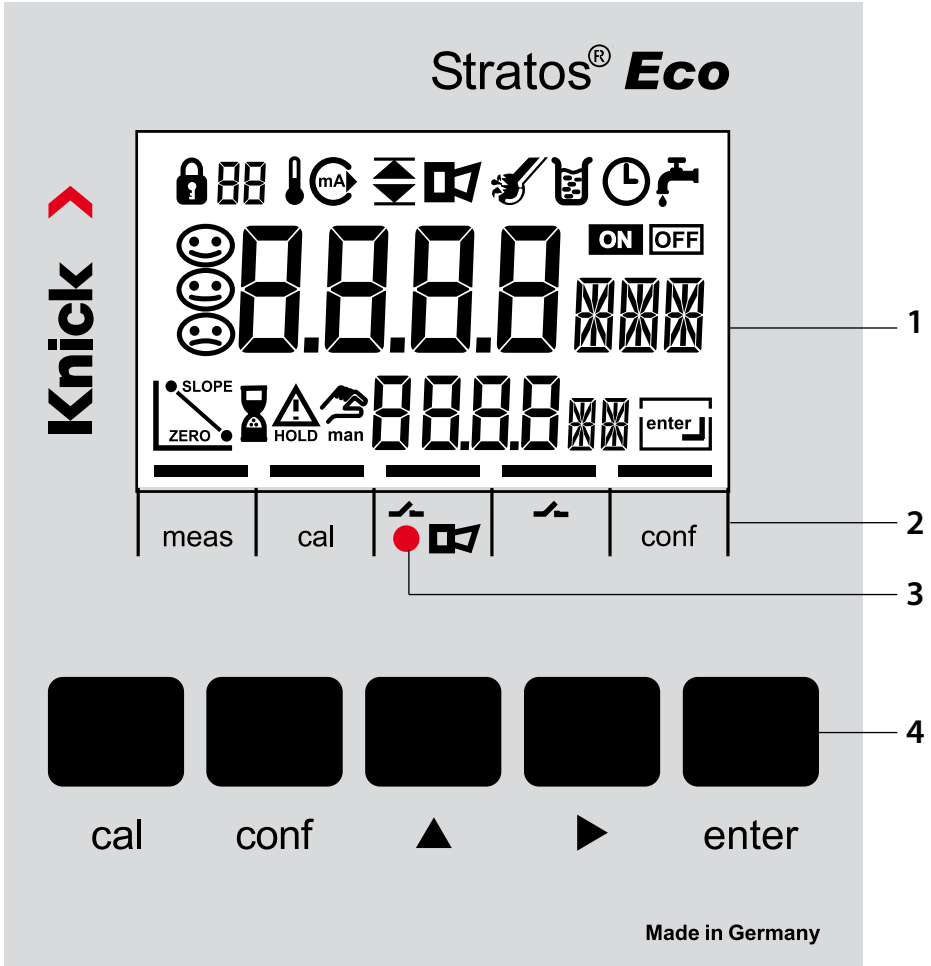

- 1 Display
- 2 Mode indicators (no keys),
from left to right:
 - Measuring mode
 - Calibration mode
 - Alarm
 - Wash contact
 - Configuration mode
- 3 Alarm LED
- 4 Keypad

Display

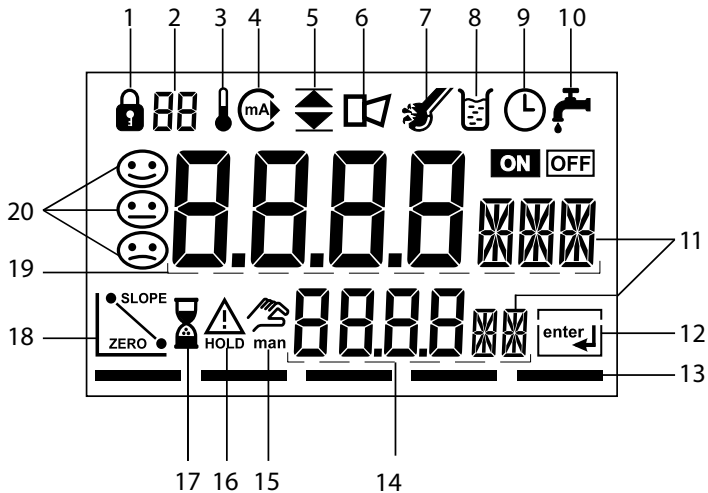

- | | | | |
|----|---|----|---------------------------|
| 1 | Passcode entry | 14 | Secondary display |
| 2 | Not in use | 15 | Manual temp specification |
| 3 | Temperature | 16 | Hold mode active |
| 4 | Current output | 17 | Waiting time running |
| 5 | Limit values | 18 | Sensor data |
| 6 | Alarm | 19 | Main display |
| 7 | Sensocheck | 20 | Sensoface |
| 8 | calibration | | |
| 9 | Interval/response time | | |
| 10 | Wash contact | | |
| 11 | Measurement symbol | | |
| 12 | Press enter to proceed | | |
| 13 | Bar for identifying the device status,
above mode indicators,
from left to right: | | |
| | - Measuring mode | | |
| | - Calibration mode | | |
| | - Alarm | | |
| | - Not in use | | |
| | - Configuration mode | | |

User Interface and Display

Operation: Keypad

cal	Start, end calibration
conf	Start, end configuration
▶	<ul style="list-style-type: none">• Select digit position (selected position blinks)• Menu navigation
▲	<ul style="list-style-type: none">• Edit digit• Menu navigation
enter	<ul style="list-style-type: none">• Calibration: Continue in program sequence• Configuration: Confirm entries, next configuration step• Measuring mode: Display output current

cal → enter	Cal Info, display of calibration data
conf → enter	Error Info: Display of last error message
▶ + ▲	Start GainCheck device self-test

Sensocheck, Sensoface Sensor Monitoring

Sensocheck continuously monitors the sensor and its wiring. Sensocheck can be switched off (Configuration, Pg 54).



Sensoface provides information on the conductivity sensor condition. Significant sensor polarization effects or an excessive cable capacitance are indicated.

GainCheck Device Self-Test

A display test is carried out, the software version is displayed, and the memory and measured-value transfer are checked.

Start GainCheck device self-test: ▶ + ▲

Automatic Device Self-Test

The automatic device self-test checks the memory and measured-value transfer. It runs automatically in the background at fixed intervals.

Safety Functions

Hold Mode

Display: 

The Hold mode is a safety state during configuration and calibration. Output current is frozen (Last) or set to a fixed value (Fix). Alarm and limit contacts are disabled.

If the calibration or configuration mode is exited, the device remains in the Hold mode for safety reasons. This prevents undesirable reactions of the connected peripherals due to incorrect configuration or calibration. The measured value and "HOLD" are displayed alternately. The device only returns to measuring mode after **enter** is pressed and 20 seconds have passed.

Configuration mode is also exited automatically 20 minutes (timeout) after the last keystroke. The device returns to measuring mode.

Timeout is not active during calibration.

Behavior of output signal:

Last: The output current is frozen at its last value.
Recommended for short configuration procedures.
The process should not change decisively during configuration.
Changes are not noticed with this setting!

Fix: The output current is set to a value that is noticeably different from the process value in order to signal the control system that the device is being worked at.

See Configuration Pg 44.

Alarm

Alarm delay is 10 seconds.



During an error message the alarm LED blinks.

Error messages can also be signaled by a 22 mA output current.

The alarm contact is activated by alarm or power failure, see also Pg 55.

Configuration

In the Configuration mode you set the device parameters.

<p>Activation</p>	<p>conf</p> 	<p>Activate by pressing conf</p> <p>Enter passcode "1200" Edit parameter using ▶ and ▲, confirm/proceed using enter. (End by pressing conf, then enter.)</p>
<p>HOLD</p> <p>During configuration the device remains in the Hold mode.</p>	 <p>↑ HOLD icon</p>	<p>The output current is frozen (at its last value or at a preset fixed value, depending on the configuration), limit and alarm contacts are inactive. Sensoface is off, "Configuration" mode indicator is on.</p>
<p>Input errors</p>		<p>The configuration parameters are checked during the input. In the case of an incorrect input "Err" is displayed for approx. 2 sec. The incorrect parameters cannot be stored. Input must be repeated.</p>
<p>End</p>	<p>conf</p> <p>enter</p>	<p>End by pressing conf. The measured value and Hold are displayed alternately, "enter" blinks.</p> <p>Press enter key to end the Hold mode. The measured value is displayed. The output current remains frozen for another 20 sec (HOLD icon on, "hourglass" blinks).</p>

Menu Structure of Configuration

The configuration steps are assigned to different menu groups. Using the arrow keys, you can jump between the individual menu groups.

Each menu group contains menu items for setting the parameters. Pressing **enter** opens a menu item.

The values are edited using the arrow keys. Pressing **enter** confirms/saves the settings.

Return to measurement: Press **conf**.

Select menu group	Menu group	Code	Display	Select menu item
▶	Output 1	o1.		↵ enter ↵ enter ↵ enter ↵ enter
		Menu item 1		
		Menu item 2		
		:		
		Menu item ...		
▶	Output 2	o2.		
▶	Temperature compensation	tc.		
▶	Alarm settings	AL.		
▶	Relay	rL.		
▶	Rinsing probes	Cn.		↻ Previous menu group: ▲

Configuration

Overview of Configuration Steps

Code	Menu	Selection / Default
out1	Output 1	
o1.CELL	Select sensor	2-electrode, 4-electrode
o1.UnIT	Select process variable	μS, mS/cm, MΩ-cm, SAL, Conc
o1.CoNC	Select solution (Conc), see Pg 39	NaCl HCl NaOH H ₂ SO ₄ HNO ₃
	Codes:	-1- -2- -3- -4- -5-
o1.rNG	Select current range	0-20 mA / 4-20 mA
o1. 4mA	Enter current start	xxxx mS
o1.20mA	Enter current end	xxxx mS
o1.FtME	Time constant of output filter	xxxx SEC
o1.FAIL	22 mA signal in the case of error	ON / OFF
o1.HoLD	Signal behavior during HOLD	Last / Fix
o1.FIX	Enter fixed value	xxx.x mA
out2	Output 2	
o2.UnIT	Select temperature unit	°C / °F
o2. rTD	Select temperature probe	Pt100/Pt1000/NTC30 kΩ/ NTC8.55 kΩ
o2.rNG	Select current range	0-20 mA / 4-20 mA
o2. 4mA	Enter current start	xxx.x
o2.20mA	Enter current end	xxx.x
o2.FtME	Time constant of output filter	xxxx SEC
o2.FAIL	22 mA signal for temperature error	ON / OFF
o2.HoLD	Signal behavior during HOLD	Last / Fix
o2.FIX	Enter fixed value	xxx.x mA
tc.	Temperature Compensation	
tc.	Select temp compensation	OFF/Lin/nLF/NaCl/HCl/NH ₃
tc. LIN	Lin: Enter temperature coefficient	xx.xx %/K

Code	Menu	Selection / Default
ALrt	Alarm settings	
AL.SnSO	Select Sensocheck	ON / OFF
rLAY	Relay 1: Limit value	
L1.FCT	Select contact function	Lo / Hi
L1.tYP	Select contact response	N/O / N/C
L1.LEVL	Enter setpoint	xxxx
L1.HYS	Enter hysteresis	xxxx
L1.dLY	Enter delay	xxxx SEC
Cn	Cleaning probes	
Cn.InTV	Rinse interval	000.0 h
Cn.rins	Rinse duration	xxxx SEC
Cn.typ	Contact response	N/C / N/O

Configuration

Output 1 Selecting the sensor type

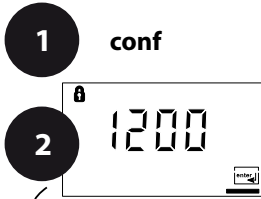

Output 1:

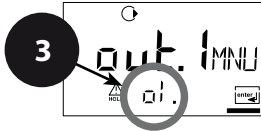

enter →

- 1 Press **conf** key.
- 2 Enter passcode **1200**.
- 3 **Output 1** menu group is displayed. All items of this menu group are indicated by the "o1." code.
- 4 Press **enter** to select menu, edit using arrow keys (see Pg 35). Confirm (and proceed) using **enter**.
- 5 End: Press **conf**, then **enter**.

4	
o1.CELL	Select sensor
o1.UnIT	Select process variable
o1.CoNC	Select solution (Conc)
o1.rNG	Select 0-20 / 4-20 mA
o1.4mA	Enter current start
o1.20mA	Enter current end
o1.FtME	Set output filter
o1.FAIL	22 mA for error
o1.HoLD	HOLD mode

5

conf enter

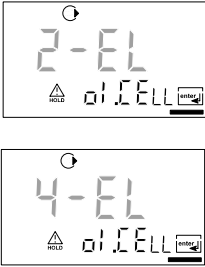
Code	Display	Action	Selection
o1.		Select evaluation method: 2-electrode sensor / 4-electrode sensor Select using ▶ key, press enter to proceed.	2-El (2-El / 4-El)

Note: Characters represented in gray are blinking and can be edited.

Configuration

Output 1 Selecting the process variable

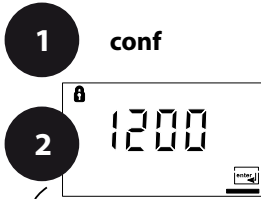

Output 1:

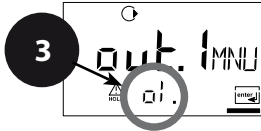

enter

- 1 Press **conf** key.
- 2 Enter passcode **1200**.
- 3 **Output 1** menu group is displayed. All items of this menu group are indicated by the "o1." code.
- 4 Press **enter** to select menu, edit using arrow keys (see Pg 37). Confirm (and proceed) using **enter**.
- 5 End: Press **conf**, then **enter**.

o1.CELL	Select sensor
o1.UnIT	Select process variable
o1.CoNC	Select solution (Conc)
o1.rNG	Select 0-20 / 4-20 mA
o1.4mA	Enter current start
o1.20mA	Enter current end
o1.FtME	Set output filter
o1.FAIL	22 mA for error
o1.HoLD	HOLD mode

4

enter

5

conf enter

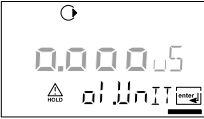
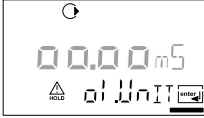
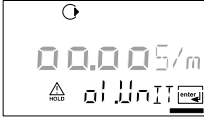
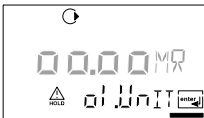
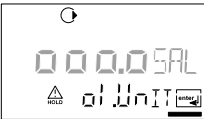
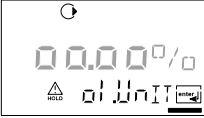
Code	Display	Action	Choices
01.	     	<p>Select process variable:</p> <p>Select using ► key, press enter to proceed.</p> <p>Conductivity: 0.000 ... 9.999 $\mu\text{S}/\text{cm}$ 00.00 ... 99.99 $\mu\text{S}/\text{cm}$ 000.0 ... 999.9 $\mu\text{S}/\text{cm}$ 0.000 ... 9.999 mS/cm 00.00 ... 99.99 mS/cm 000.0 ... 999.9 mS/cm 0.000 ... 9.999 S/m 00.00 ... 99.99 S/m</p> <p>Resistivity: 00.00 ... 99.99 $\text{M}\Omega\text{-cm}$</p> <p>Salinity (SAL): 0.0 ... 45.0 ‰ (0 ... 35 °C)</p> <p>Concentration (Conc): 0.00 ... 9.99% by wt</p>	<p>000.0 mS (0.000 μS 00.00 μS 000.0 μS 0000 μS 0.000 mS 00.00 mS 000.0 mS 0.000 S/m 00.00 S/m 000.0 S/m 00.00 $\text{M}\Omega\text{-cm}$ 000.0 SAL 00.00 %)</p>

Configuration

Output 1

Concentration measurement: Select process solutions

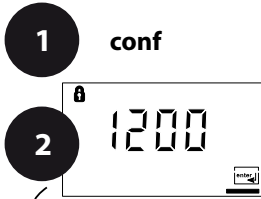

Output 1:

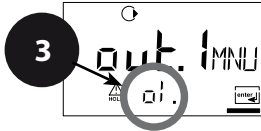

- 1 Press **conf** key.
- 2 Enter passcode **1200**.
- 3 **Output 1** menu group is displayed. All items of this menu group are indicated by the "o1." code.
- 4 Press **enter** to select menu, edit using arrow keys (see Pg 39). Confirm (and proceed) using **enter**.
- 5 End: Press **conf**, then **enter**.

enter →

o1.CELL	Select sensor
o1.UnIT	Select process variable
o1.CoNC	Select solution (Conc)
o1.rNG	Select 0-20 / 4-20 mA
o1.4mA	Enter current start
o1.20mA	Enter current end
o1.FtME	Set output filter
o1.FAIL	22 mA for error
o1.HoLD	HOLD mode

enter

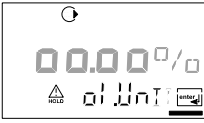
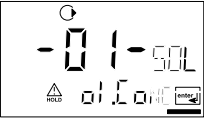
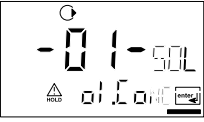
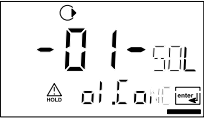
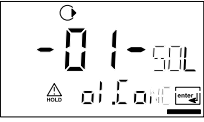
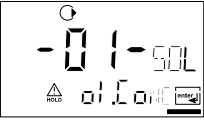

conf **enter**

Code	Display	Action	Choices
o1.		Only with 00.00 % Conc can you select the process solution. Select using arrow key ▶	-01-SOL (-01-SOL -02-SOL -03-SOL -04-SOL -05-SOL)
		-01- NaCl (0.00 ... 9.99 % by wt) (0 ... 120 °C)	
		-02- HCl (0.00 ... 9.99 % by wt) (-20 ... 50 °C)	
		-03- NaOH (0.00 ... 9.99 % by wt) (0 ... 100 °C)	
		-04- H ₂ SO ₄ (0.00 ... 9.99 % by wt) (-17 ... 110 °C)	
		-05- HNO ₃ (0.00 ... 9.99 % by wt) (-20 ... 50 °C)	
		Press enter to proceed.	

Concentration Measurement

For the solutions listed above, the device can determine the substance concentration from the measured conductivity and temperature values in % by wt. The measurement error is made up of the sum of measurements errors during conductivity and temperature measurement and the accuracy of the concentration curves stored in the device, see Pg 90.

We recommend to calibrate the device together with the sensor. For exact temperature measurement, you should perform a temperature probe adjustment. For measuring processes with rapid temperature changes, use a separate temperature probe with fast response.

Configuration

Output 1

Output current range, current start, current end

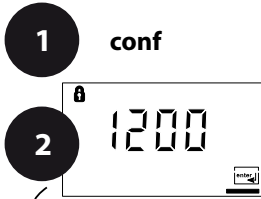

Output 1:

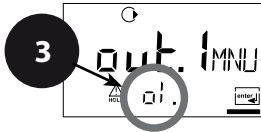

- 1 Press **conf** key.
- 2 Enter passcode **1200**.
- 3 **Output 1** menu group is displayed. All items of this menu group are indicated by the "o1." code.
- 4 Press **enter** to select menu, edit using arrow keys (see Pg 41). Confirm (and proceed) using **enter**.
- 5 End: Press **conf**, then **enter**.

enter →

o1.CELL	Select sensor
o1.UnIT	Select process variable
o1.CoNC	Select solution (Conc)
o1.rNG	Select 0-20 / 4-20 mA
o1.4mA	Enter current start
o1.20mA	Enter current end
o1.FtME	Set output filter
o1.FAIL	22 mA for error
o1.HoLD	HOLD mode



4

enter

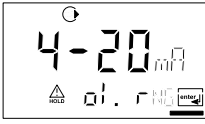

5

conf enter

Code	Display	Action	Choices
o1.		Set output current range Select using ▶ key, press enter to proceed.	4-20 mA (0 - 20 mA/ 4 - 20 mA)
		Current start Enter lower end of scale. Select using ▶ key, edit number using ▲ key, press enter to proceed.	000.0 mS (xxx.x mS)
		Current end Enter upper end of scale. Select using ▶ key, edit number using ▲ key, press enter to proceed.	100.0 mS (xxx.x mS)

Assignment of Measured Values: Current Start and Current End

Example 1: Range 0...200 mS/cm

Example 2: Range 100...200 mS/cm
Advantage: Higher resolution in
range of interest

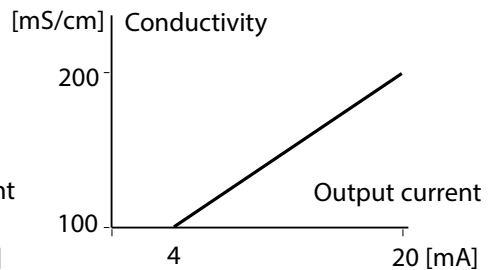
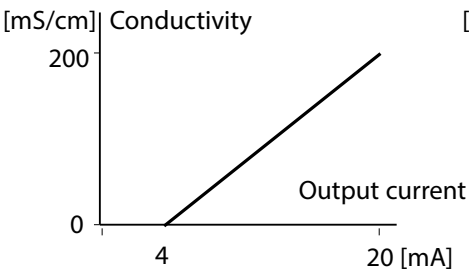

Configuration

Output 1

Time constant of output filter

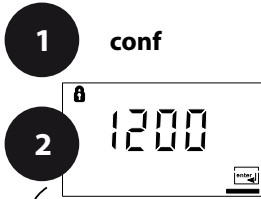

Output 1:

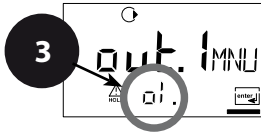

enter

- 1 Press **conf** key.
- 2 Enter passcode **1200**.
- 3 **Output 1** menu group is displayed. All items of this menu group are indicated by the "o1." code.
- 4 Press **enter** to select menu, edit using arrow keys (see Pg 43). Confirm (and proceed) using **enter**.
- 5 End: Press **conf**, then **enter**.



o1.CELL	Select sensor	enter
o1.UnIT	Select process variable	
o1.CoNC	Select solution (Conc)	enter
o1.rNG	Select 0-20 / 4-20 mA	
o1.4mA	Enter current start	
o1.20mA	Enter current end	
o1.FtME	Set output filter	
o1.FAIL	22 mA for error	
o1.HoLD	HOLD mode	



conf enter

Code	Display	Action	Choices
o1.		Time constant of output filter Default setting: 0 s (inactive). To specify a time constant: Select using ► key, edit number using ▲ key, press enter to proceed.	0 sec 0 ... 120 sec

Time Constant of Output Filter (Attenuation)

To smoothen the current output, a low-pass filter with adjustable filter time constant can be switched on. When there is a jump at the input (100 %), the output level is at 63 % after the time constant has been reached.

The time constant can be set from 0 to 120 sec.

If the time constant is set to 0 sec, the current output follows the input.

Please note:

The filter only acts on the current output, not on the display or the limit value!

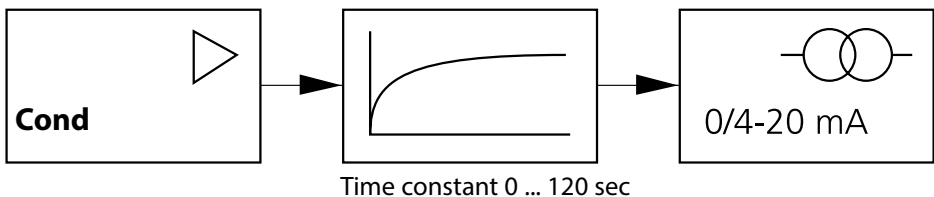

Configuration

Output 1

Output current during Error and HOLD

1 **conf**



2
Output 1:

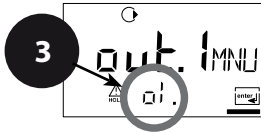

- 1 Press **conf** key.
- 2 Enter passcode **1200**.
- 3 **Output 1** menu group is displayed. All items of this menu group are indicated by the "o1." code.
- 4 Press **enter** to select menu, edit using arrow keys (see Pg 45). Confirm (and proceed) using **enter**.
- 5 End: Press **conf**, then **enter**.

enter →

o1.CELL	Select sensor
o1.UnIT	Select process variable
o1.CoNC	Select solution (Conc)
o1.rNG	Select 0-20 / 4-20 mA
o1.4mA	Enter current start
o1.20mA	Enter current end
o1.FtME	Set output filter
o1.FAIL	22 mA for error
o1.HoLD	HOLD mode



4

enter

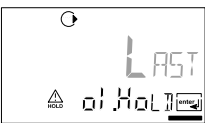
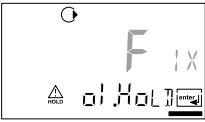

5

conf enter

Code	Display	Action	Choices
o1.		22 mA signal for error message Select using ▶ key, press enter to proceed.	OFF (OFF / ON)
		Output signal during HOLD LAST: During HOLD the last measured value is maintained at the output FIX: During HOLD a value (to be entered) is maintained at the output Select using ▶ key, press enter to proceed.	LAST (LAST / FIX)
	 	Only with FIX selected: Enter current which is to flow at the output during HOLD Select position using ▶ key and edit number using ▲ key. Press enter to proceed.	21.0 mA (00.0 ... 21.0 mA)

Output Signal During HOLD:

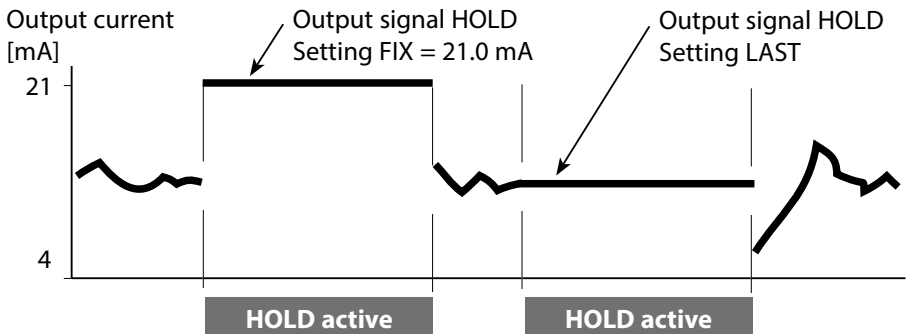

Configuration

Output 2

Temperature unit and probe, output current

1 **conf**

1 Press **conf** key.



2 Enter passcode **1200**.

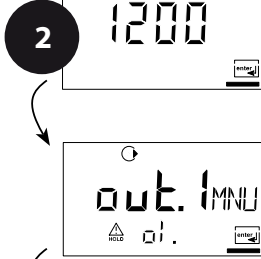

3 Select **Output 2** menu group using arrow keys. All items of this menu group are indicated by the "o2." code.

Output 2:

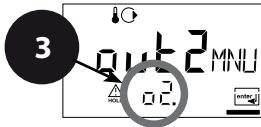

4 Press **enter** to select menu, edit using arrow keys (see Pg 47).

Confirm (and proceed) using **enter**.

5 End: Press **conf**, then **enter**.





enter

o2.UnIT	Select °C/°F
o2. rTD	Select temp probe
o2.rNG	Select 0-20 / 4-20 mA
o2. 4mA	Enter current start
o2.20mA	Enter current end
o2.FtME	Set output filter
o2.FAIL	22 mA for temp error
o2.HoLD	HOLD mode

enter

5

conf enter

Code	Display	Action	Choices
o2.		Specify temperature unit Select using ▶ key, press enter to proceed.	°C (°C / °F)
		Select temperature probe Select using ▶ key, press enter to proceed.	Pt100 (Pt1000, NTC30 kΩ, NTC8.55 kΩ)
		Select output current range Select using ▶ key, press enter to proceed.	4 - 20 mA (4 - 20 mA/ 0 - 20 mA)
		Current start: Enter lower end of scale. Select using ▶ key, edit number using ▲ key, press enter to proceed.	000.0 °C (xxx.x °C)
		Current start: Enter upper end of scale. Select using ▶ key, edit number using ▲ key, press enter to proceed.	100.0 °C (xxx.x °C)

Process Temperature: Current Start and Current End

Example 1: Range 0 ... 100 °C

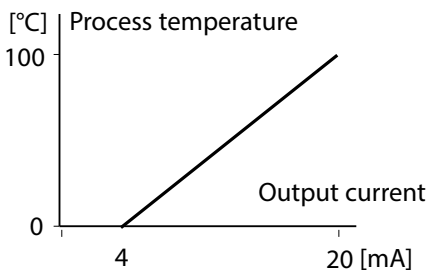

Example 2: Range 50 ... 70 °C
Advantage: Higher resolution in
range of interest

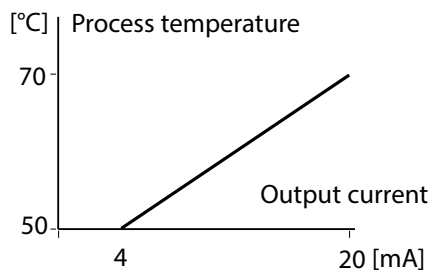

Configuration

Output 2

Time constant of output filter

- 1 Press **conf** key.
- 2 Enter passcode **1200**.
- 3 Select **Output 2** menu group using arrow keys. All items of this menu group are indicated by the "o2." code.
- 4 Press **enter** to select menu, edit using arrow keys (see Pg 49). Confirm (and proceed) using **enter**.
- 5 End: Press **conf**, then **enter**.

o2.UnIT	Select °C/°F
o2. rTD	Select temp probe
o2.rNG	Select 0-20 / 4-20 mA
o2. 4mA	Enter current start
o2.20mA	Enter current end
o2.FtME	Set output filter
o2.FAIL	22 mA for temp error
o2.HoLD	HOLD mode

5

conf enter

Code	Display	Action	Choices
o2.		Time constant of output filter Default setting: 0 sec (inactive). To specify a time constant: Select using ▶ key, edit number using ▲ key, press enter to proceed.	0 sec (0 ... 120 sec)

Time Constant of Output Filter

To smoothen the current output, a low-pass filter with adjustable filter time constant can be switched on. When there is a jump at the input (100 %), the output level is at 63 % after the time constant has been reached.

The time constant can be set from 0 to 120 sec.

If the time constant is set to 0 sec, the current output follows the input.

Please note:

The filter only acts on the current output, not on the display!

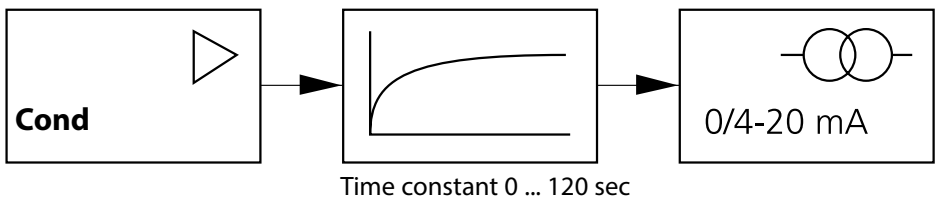

Configuration

Output 2

Temperature error, output current during HOLD

1 **conf**

- 1 Press **conf** key.
- 2 Enter passcode **1200**.
- 3 Select **Output 2** menu group using arrow keys. All items of this menu group are indicated by the "o2." code.
- 4 Press **enter** to select menu, edit using arrow keys (see Pg 51). Confirm (and proceed) using **enter**.
- 5 End: Press **conf**, then **enter**.

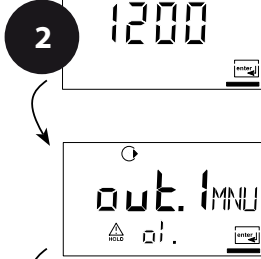

Output 2:

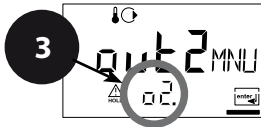

enter



o2.UnIT	Select °C/°F
o2. rTD	Select temp probe
o2.rNG	Select 0-20 / 4-20 mA
o2. 4mA	Enter current start
o2.20mA	Enter current end
o2.FtME	Set output filter
o2.FAIL	22 mA for temp error
o2.HoLD	HOLD mode

enter

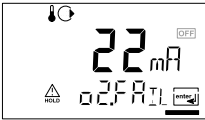
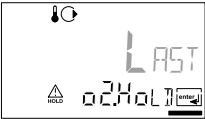

5

conf enter

Code	Display	Action	Choices
o2.		22 mA signal for error message Select using ▶ key, press enter to proceed.	OFF (OFF / ON)
		Output signal during HOLD LAST: During HOLD the last measured value is maintained at the output FIX: During HOLD a value (to be entered) is maintained at the output Select using ▶ key, press enter to proceed.	LAST (LAST / FIX)
	 	Only with FIX selected: Enter current which is to flow at the output during HOLD Select position with ▶ key and edit number with ▲ key. Press enter to proceed.	21.0 mA (00.0 ... 21.0 mA)

Output Signal During HOLD:

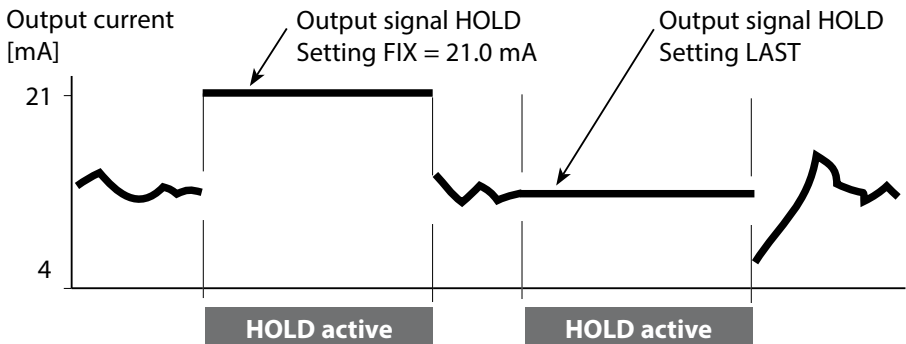

Configuration

Temperature Compensation







Temp compensation selection

- 1 Press **conf** key.
- 2 Enter passcode **1200**.
- 3 Select **Temperature compensation** menu group using arrow keys. All items of this menu group are indicated by the "tc." code.
- 4 Press **enter** to select menu, edit using arrow keys (see Pg 53). Confirm (and proceed) using **enter**.
- 5 End: Press **conf**, then **enter**.

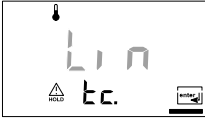
Temp compensation:

enter tc. Temp compensation

5 **conf enter**

Code	Display	Action	Choices
tc.	     	<p>Select temp compensation</p> <p>OFF: Temperature compensation switched off Select using ▶ key, press enter to proceed.</p> <p>LIN: Linear temperature compensation with entry of temperature coefficient and reference temperature</p> <p>nLF: Temperature compensation for natural waters to EN 27888</p> <p>NaCl (nACL): Temperature compensation for ultrapure water with NaCl traces</p> <p>HCl (HCL): Temperature compensation for ultrapure water with HCl traces</p> <p>NH₃ (nH3): Temperature compensation for ultrapure water with NH₃ traces</p>	<p>OFF (OFF LIN nLF nACL HCL nH3)</p>
		<p>Only with linear temperature compensation (LIN) selected: Enter temperature coefficient. Select position using ▶ key and edit number using ▲ key. Press enter to proceed.</p>	<p>02.00%/K (XX.XX %/K)</p>

Configuration

Alarm Settings

1 **conf**

2



3

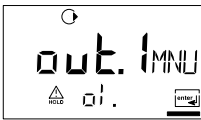

4

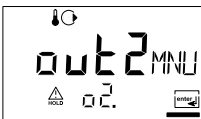

5

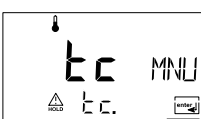

Alarm settings:



enter → **AL.SnSO** Select Sensocheck

4

5 **conf enter**

Code	Display	Action	Choices
AL.		Select Sensocheck (continuous monitoring of sensor) Select using ▶ key, press enter to proceed.	OFF (ON / OFF)

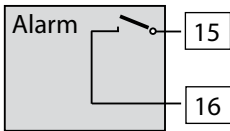

Alarm Contact

The alarm contact is closed during normal operation (N/C). It opens in the case of alarm or power outage. As a result, a failure message is provided even in the case of line breakage (fail-safe behavior).

For contact ratings, see Specifications.

Error messages can also be signaled by a 22 mA output current (see Pg 44, 50, 75).

The operating behavior of the alarm contact is shown on Pg 77.

The **alarm delay** acts on the LED, the 22 mA signal and the alarm contact.

Configuration

Limit Function Relay

1 **conf**

2 

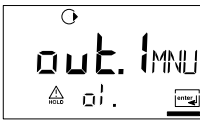

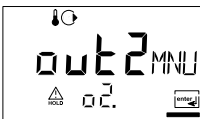





3 **Limit function:**

- 1 Press **conf** key.
- 2 Enter passcode **1200**.
- 3 Select **Limit function** menu group using arrow keys. All items of this menu group are indicated by the "L1." code.
- 4 Press **enter** to select menu, edit using arrow keys (see Pg 57). Confirm (and proceed) using **enter**.
- 5 End: Press **conf**, then **enter**.

4

L1.FCT	Contact function	enter
L1.tYP	Contact response	enter
L1.LEVL	Enter setpoint	enter
L1.HYS	Enter hysteresis	
L1.dLY	Delay	

5

conf enter

Code	Display	Action	Choices
L1.		Contact function (see below for function principle) Select using ▶ key, press enter to proceed.	Lo (Lo/Hi)
		Contact response N/C: normally closed contact N/O: normally open contact Select using ▶ key, press enter to proceed.	N/O (N/O N/C)
		Setpoint Select using ▶ key, edit number using ▲ key, press enter to proceed.	000.0 mS (xxx.x mS)
		Hysteresis Select using ▶ key, edit number using ▲ key, press enter to proceed.	001.0 mS (xxx.x mS)
		Delay The contact is activated with delay (deactivated without delay) Select using ▶ key, edit number using ▲ key, press enter to proceed.	0010 sec (0 ... 9999 sec)

Limit Lo

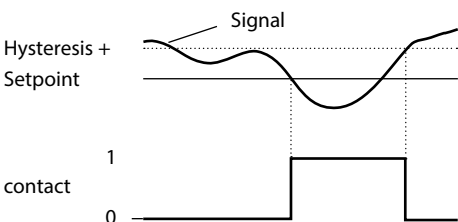

Limit Hi

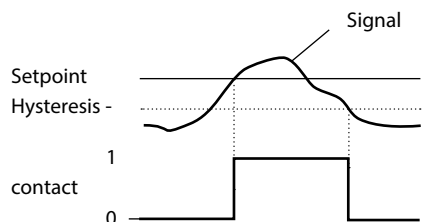

Controlling a Rinsing Probe “Clean” contact

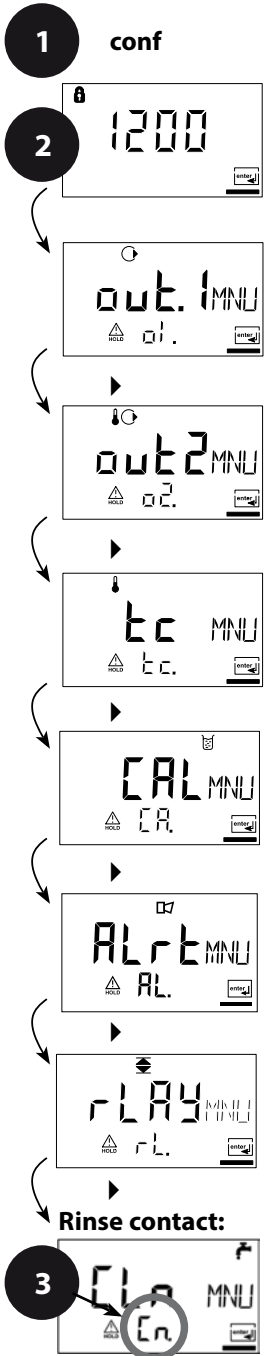



- 1 Press **conf** key.
- 2 Enter passcode **1200**.
- 3 Select **Rinsing probes** menu group using arrow keys. All items of this menu group are indicated by the “Cn.” code.
- 4 Press **enter** to select menu, edit using arrow keys (see next page). Confirm (and proceed) using **enter**.
- 5 End: Press **conf**, then **enter**.

Cn.InTV	Rinsing interval	
Cn.rins	Rinse duration	
Cn.typ	Contact response	

enter

5

conf enter

Code	Display	Action	Choices
Cn.		Rinsing interval Select using ▶ key, enter number using ▲, press enter to proceed.	0000 h (x.xxx h)
		Rinse duration Select using ▶ key, enter number using ▲, press enter to proceed.	0060 sec (xxxx sec)
		Contact response N/C: normally closed contact N/O: normally open contact Select using ▶, press enter to proceed.	N/C (N/O)

Connecting a Rinsing System

The "Clean" contact can be used to connect a simple spray cleaning system. Rinse duration and rinsing interval are defined during configuration.

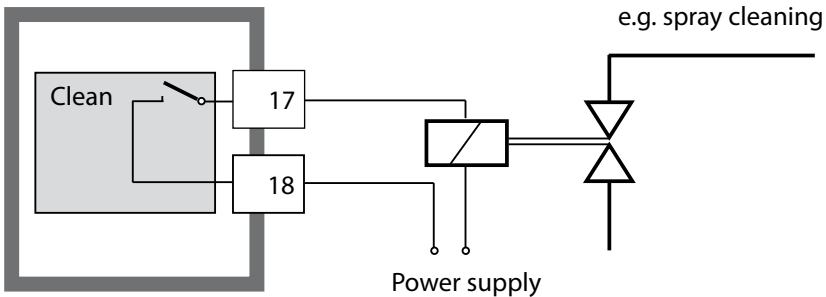

Parameters

Factory Settings of Parameters

Activation:

Simultaneously press **conf** + right arrow key and enter passcode "4321".

The lower display line reads "Clear". To prevent accidental resetting, "NO" is set as default (blinking in the main display).

Press one of the arrow keys to select "YES" and confirm by pressing **enter**.

CAUTION!

Your data (also calibration data) will be overwritten by the factory settings!

Code	Parameters	Factory setting
o1.CELL	Select sensor	2-EL
o1.UnIT	Process variable	000.0 mS
o1.CoNC	Conc solution	-01-
o1. rNG	0/4-20 mA	4-20 mA
o1. 4mA	Current start	000.0 mS
o1.20mA	Current end	100.0 mS
o1.FtME	Filter time	0 s
o1.FAIL	22mA signal	OFF
o1.HoLD	HOLD response	Last
o1.FIX	Fix current	021.0 mA
o2.UnIT	Unit °C / °F	°C
o2.rTD	Temp probe	Pt100
o2.rNG	0/4-20 mA	4-20 mA
o2. 4mA	Current start	000.0 °C
o2.20mA	Current end	100.0 °C
o2.FtME	Filter time	0 s
o2.FAIL	22mA signal	OFF
o2.HoLD	HOLD response	Last
o2.FIX	Fix current	021.0 mA

Code	Parameters	Factory setting
tc.	Temp compensation	OFF
tc. LIN	Temp coefficient	02.00%/K
AL.SnSO	Sensocheck	OFF
L1.FCT	Contact function	Lo
L1.tYP	Contact response	N/O
L1.LEVL	Setpoint	000.0 mS
L1.HYS	Hysteresis	001.0 mS
L1.dLY	Delay	0010 sec
Cn.InTV	Rinsing interval	000.0 h
Cn.rins	Rinse duration	0060 sec
Cn.typ	Contact type	N/C

Please note:

Fill in your configuration data on the following pages.

Please note:

The cell constant is factory set to 1.0000 cm⁻¹.

Parameters



Parameters – Individual Settings

Code	Parameter	Setting
o1.CELL	Sensor	
o1.UnIT	Process variable	
o1.CoNC	Solution (Conc)	
o1. rNG	0/4-20 mA	
o1. 4mA	Current start	
o1.20mA	Current end	
o1.FtME	Filter time	
o1.FAIL	22mA signal	
o1.HoLD	HOLD response	
o1.FIX	Fix current	
o2.UnIT	Unit °C / °F	
o2.rTD	Temp probe	
o2.rNG	0/4-20 mA	
o2. 4mA	Current start	
o2.20mA	Current end	

Code	Parameter	Setting
o2.FtME	Filter time	
o2.FAIL	22mA signal	
o2.HoLD	HOLD response	
o2.FIX	Fix current	
tc.	Temp compensation	
tc. LIN	Temp coefficient	
AL.SnSO	Sensocheck	
L1.FCT	Contact function	
L1.tYP	Contact response	
L1.LEVL	Setpoint	
L1.HYS	Hysteresis	
L1.dLY	Delay	
Cn.InTV	Rinsing interval	
Cn.rins	Rinse duration	
Cn.typ	Contact type	

Calibration

Calibration adjusts the device to the sensor.

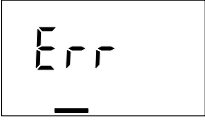
Activation	cal	Activate by pressing cal
		<p>Activate by pressing cal</p> <p>Enter passcode:</p> <ul style="list-style-type: none"> • Entry of cell constant 1100 • With calibration solution 0110 • Product calibration 1105 • Temp probe adjustment 1015 <p>Select using ▲ key. Edit parameter using ▶ . Press enter to proceed. (End by pressing cal, then enter.)</p>
<p>HOLD</p> <p>During calibration the device remains in the Hold mode.</p>	 <p style="text-align: center;">↑</p> <p>HOLD icon</p>	<p>Output current is frozen (last value or preset fixed value, depending on configuration), limit and alarm contacts are inactive. Sensoface is off, "Calibration" mode indicator is on.</p>
<p>Input errors</p>		<p>The calibration parameters are checked during the input. In the case of an incorrect input "Err" is displayed for approx. 2 sec. The incorrect parameters cannot be stored. Input must be repeated.</p>
<p>End</p>	<p>enter</p> <p>enter</p>	<p>End by pressing enter (abort using cal). The measured value and Hold are displayed alternately, "enter" blinks. Sensoface is active. Press enter to end the Hold mode. The measured value is displayed. The output current remains frozen for another 20 sec (HOLD icon on, "hourglass" blinks).</p>

Information on Calibration

Calibration adapts the device to the conductivity sensor.

Calibration can be performed by:



- Input of cell constant (e.g. for ultrapure-water sensors)
- Determining the cell constant with a known calibration solution (conductivity standard)
- Product calibration (calibration by comparison)
- Temperature probe adjustment

Please note:

- All calibration procedures must be performed by trained personnel.
- Incorrectly set parameters may go unnoticed, but change the measuring properties.

Calibration by Entry of Cell Constant

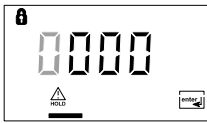
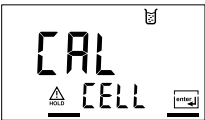
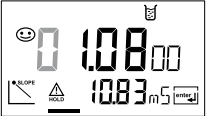
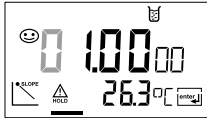
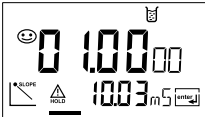



Input of cell constant with simultaneous display of uncorrected conductivity value and temperature

Display	Action	Remark
	Press cal key, enter code 1100. Select using ▶ key, edit number using ▲ key, press enter to proceed.	Device is in the Hold mode. If an invalid code is entered, the device returns to measuring mode.
	Ready for calibration	Display (2 sec)
   	<p>Enter cell constant of connected sensor:</p> <p>Select using ▶ , enter number using ▲</p> <p>A change in the cell constant also changes the conductivity value.</p> <p>Press enter to confirm cell constant.</p>	<p>The lower display shows the measured conductivity value. (When there has not been an entry for 6 sec, the lower display alternately shows the conductivity and temperature value.)</p>

Display	Action	Remark
	<p>The device now displays the conductivity and temperature.</p>	
	<p>The measured value is shown in the main display alternately with "Hold", "enter" blinks. End calibration by pressing enter.</p>	<p>After end of calibration, the outputs remain in Hold mode for approx. 20 sec.</p>

Calibration with Calibration Solution

Input of temperature-corrected value of calibration solution (calibration standard) with simultaneous display of cell constant

Display	Action	Remark
	Press cal key, enter code 0110. Select using ▶ key, edit number using ▲ key, press enter to proceed.	Device is in the Hold mode. If an invalid code is entered, the device returns to measuring mode.
	Ready for calibration Remove and clean sensor	Display (2 sec)
	Immerse sensor in calibration solution. Determine the temperature-corrected conductivity value of the calibration solution from the corresponding table (see Pg 86).	When there has not been an entry for 6 sec, the lower display alternately shows the cell constant and temperature value.
 	Enter value of calibration solution. Select using ▶ key, edit number using ▲ key. Press enter to confirm the calibration.	The cell constant and temperature are alternately displayed in the lower display during the input.

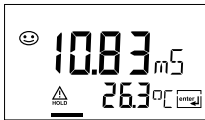
Display	Action	Remark
	<p>The determined cell constant is displayed. Press enter to confirm.</p>	
	<p>The device now displays the conductivity and temperature.</p>	
	<p>Clean sensor and re-place it in the process. The measured value is shown in the main display alternately with "Hold". "enter" blinks. End calibration by pressing enter.</p>	<p>After end of calibration, the outputs remain in Hold mode for approx. 20 sec.</p>

Please note:

- Be sure to use known calibration solutions with the respective temperature-corrected conductivity values (see "Calibration Solutions" Pg 88 et seq.).
- Make sure that the temperature does not change during the calibration procedure.



Calibration

Product Calibration

Calibration by comparison



For product calibration the measured variable is used as configured: conductivity ($\mu\text{S}/\text{cm}$, mS/cm , S/m), resistivity ($\text{M}\Omega\text{-cm}$). During product calibration the sensor remains in the process. The measurement is only interrupted briefly. Calibration is without TC correction.

Procedure: The currently measured value is stored in the device for comparison. A sample is measured using a portable meter. The sample value is then entered in the device. The new cell constant is calculated from these two values.

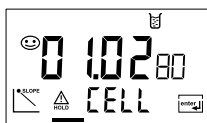
Display	Action	Remark
	Press cal key, enter code 1105. Press ▶ key to select position, enter number using ▲ key, press enter to confirm.	If an invalid code is entered, the device returns to measuring mode.
		Display (approx. 2 sec)
	Save currently measured value. Press enter to proceed.	Perform reference measurement.

Display	Action	Remark
 <p>The LCD display shows the value 1.285 mS. Below the value, the word 'CALC' is displayed. There are several small icons around the display, including a triangle with a circle inside, a square with a circle inside, and a square with a circle and a line inside.</p>	<p>Enter sample value. The new cell constant is calculated.</p>	
 <p>The LCD display shows the value 0.10280. Below the value, the word 'CELL' is displayed. There are several small icons around the display, including a triangle with a circle inside, a square with a circle inside, and a square with a circle and a line inside.</p>	<p>The determined cell constant is displayed. Press enter to confirm.</p>	<p>New calibration: Press cal.</p>
	<p>The new value is shown in the main display alternately with "Hold", "enter" blinks. End by pressing enter.</p>	<p>After end of calibration, the outputs remain in Hold mode for approx. 20 sec.</p>

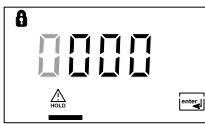



Temp Probe Adjustment

Display	Action	Remark
	Select calibration Press cal key, enter code 1015. Press ▶ key to select position, enter number using ▲ key, press enter to confirm.	Wrong settings change the measurement properties! If an invalid code is entered, the device returns to measuring mode.
	Ready for calibration Measure the temperature of the process medium using an external thermometer	Device is in Hold mode. Display approx. 2 sec
	Enter measured temperature value. Select using ▶ key, edit number using ▲ key, press enter to proceed. End adjustment by pressing enter . HOLD will be deactivated after 20 sec.	Default: Value of secondary display.

Measurement





Display	Action
	In the measuring mode the main display shows the configured process variable (conductivity, resistivity, or SAL) and the lower display the temperature. During calibration you can return to measuring mode by pressing the cal key, during configuration by pressing conf (waiting time for signal stabilization approx. 20 sec).

Diagnostics Functions

Display	Action
 The display shows a main reading of 13.2 mA and a secondary reading of 12.5 mA. A small circular icon is visible in the top left corner.	Display of output currents Press enter while in measuring mode. The current at output 1 is shown in the main display, the current at output 2 in the secondary display. After 5 sec the device returns to measuring mode.
 The display shows a main reading of 10.0000 and the word CELL below it. A smiley face icon is in the top left, and a slope indicator icon is in the bottom left.	Display of calibration data (Cal Info) Press cal while in measuring mode and confirm code 0000. The current cell constant is shown in the main display. After 20 sec the device returns to measuring mode (immediate return at pressing enter).
 The display shows a main reading of 1.002 KΩ and a secondary reading of 38.2 °C. A slope indicator icon is in the bottom right.	Sensor monitor for validation of sensor and complete signal processing. Press conf while in measuring mode and enter code 2222. The measured resistance is shown in the main display, the measuring temperature in the lower display. Press enter to return to measurement.
 The display shows the word LAST in large letters and the word Error in smaller letters below it. A smiley face icon is in the top left, and a slope indicator icon is in the bottom right.	Display of last error message (Error Info) Press conf while in measuring mode and confirm code 0000. The last error message is displayed for approx. 20 sec. After that the message will be deleted (immediate return to measurement at pressing enter).

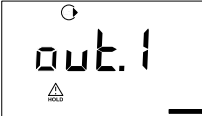
Diagnostics Functions















These functions are used for testing the connected peripherals.

Display	Action
	Specify current at output 1 Press conf while in measuring mode, enter code 5555. The current indicated in the main display for output 1 can be edited.
	Select using ▶ key, edit number using ▲ key. Press enter to confirm entry. The entered value will be shown in the secondary display. The device is in Hold mode. Press conf , then enter to return to measurement (Hold remains active for another 20 sec).
	Specify current at output 2 Press conf while in measuring mode, enter code 5556. The current indicated in the main display for output 2 can be edited.
	Select using ▶ key, edit number using ▲ key. Press enter to confirm entry. The entered value will be shown in the secondary display. The device is in Hold mode. Press conf , then enter to return to measurement (Hold remains active for another 20 sec).































Error Messages (Error Codes)

Error	Display	Problem Possible causes	Alarm contact	Red LED	Out 1 (22 mA)	Out 2 (22 mA)
ERR 01	Measured value blinks	Sensor <ul style="list-style-type: none"> • Wrong cell constant • Measuring range violation • SAL > 45 ‰ • Sensor connection or cable defective 	x	x	x	
ERR 02	Measured value blinks	Unsuitable sensor Conductance range > 3500 mS	x	x	x	
ERR 98	"Conf" blinks	System error Configuration or calibration data defective; completely reconfigure the device using the factory settings. Then calibrate. Memory error in device program	x	x	x	x
ERR 99	"FAIL" blinks	Factory settings EEPROM or RAM defective This error message only occurs in the case of a total defect. The device must be repaired and recalibrated at the factory.	x	x	x	x

Error Messages (Error Codes)

Error	Icon (blinks)	Problem Possible causes	Alarm contact	Red LED	Out 1 (22 mA)	Out 2 (22 mA)
ERR 03		Temperature probe Open or short circuit Temperature range exceeded	x	x	x	x
ERR 11		Current output 1 Current below 0 (3.8) mA	x	x	x	
ERR 12		Current output 1 Current above 20.5 mA	x	x	x	
ERR 13		Current output 1 Current span too small / too large	x	x	x	
ERR 21	 	Current output 2 Current below 0 (3.8) mA	x	x		x
ERR 22	 	Current output 2 Current above 20.5 mA	x	x		x
ERR 23	 	Current output 2 Current span too small / too large	x	x		x
ERR 33	 	Sensocheck: Wrong or defective sensor / polarization effects at the sensor / cable too long or defective / plug defective	x	x	x	
	 	Temperature outside conversion tables (TC, conc, SAL)				

Operating States

Operating status	Out 1	Out 2	Relay 1 limit value	Alarm contact	Cleaning contact	Timeout
Measure						
Cal Info (cal) 0000						20 s
Error Info (conf) 0000						20 s
Calibration (cal) 1100						
Temp adjustment (cal) 1015						
Product calibration (cal) 1105						
Configuration (conf) 1200						20 min
Sensor monitor (conf) 2222						20 min
Current source 1 (conf) 5555						20 min
Current source 2 (conf) 5556						20 min
Rinsing function						

 active

 as configured (Last/Fix or Last/Off)

Sensoface

The smiley in the display (Sensoface) provides information about the sensor condition (defects, maintenance required, cable capacitance too high). It alerts to significant sensor polarization or excessive cable capacitance e.g. caused by an unsuitable cable or a cable that is too long. The permitted calibration ranges and the conditions for a friendly, neutral, or sad Sensoface are summarized in the following chart. Additional icons refer to the error cause.

Sensocheck

Continuously monitors the sensor and its wiring. Sensocheck can be switched off. Critical values make the Sensoface “sad” and the corresponding icon blinks:







The Sensocheck message is also output as error message Err 33. The alarm contact is active, the red LED is lit, output current 1 is set to 22 mA (when configured correspondingly). Sensocheck can be switched off during configuration (then Sensoface is also disabled).

Exception: After a calibration a smiley is always displayed for confirmation.

Notice

The worsening of a Sensoface criterion leads to the devaluation of the Sensoface indicator (Smiley becomes “sad”). An improvement of the Sensoface indicator can only take place after calibration or removal of the sensor defect.

Display	Problem	Status
	Sensor defect	 Wrong or defective sensor Significant polarization of sensor Excessive cable capacitance (see also Err 33, Error Messages on Pg 76).
	Temperature error	 Temperature outside range for TC, conc, SAL

Please note:

When very fast response times (t_{90}) are required, e.g. when detecting separation layers, Sensocheck should be switched off (see “Specifications” Pg 82).

Product Line and Accessories

Devices

Stratos Eco 2405 Cond

Order No.

2405 Cond

Mounting Accessories

Pipe-mount kit

ZU 0274

Panel-mount kit

ZU 0275

Protective hood

ZU 0276

For more information concerning our sensors and fittings product line,
please refer to our website:
www.knick.de

Specifications

Conductivity input	Input for 2-electrode/4-electrode sensors	
Effective range	Conductivity	0.2 $\mu\text{S} \cdot \text{cm} \dots 1000 \text{ mS} \cdot \text{cm}$
Measuring ranges	Conductivity	0.000 ... 9.999 $\mu\text{S}/\text{cm}$
		00.00 ... 99.99 $\mu\text{S}/\text{cm}$
		000.0 ... 999.9 $\mu\text{S}/\text{cm}$
		0000 ... 9999 $\mu\text{S}/\text{cm}$
		0.000 ... 9.999 mS/cm
		00.00 ... 99.99 mS/cm
		000.0 ... 999.9 mS/cm
		0,000 ... 9.999 S/m
		00.00 ... 99.99 S/m
		Resistivity
Concentration	0.00 ... 9.99 % by wt	
Salinity	0.0 ... 45 ‰ (0 ... 35 °C)	
Response time (T_{90})	< 1 s (Sensocheck off)	
	< 3 s (Sensocheck on)	
Meas. error ^{1,2,3)}	< 1 % meas. val. + 0.4 $\mu\text{S} \cdot \text{cm}$	
Concentration determination		
Operating modes *	-01-	NaCl 0.00...9.99 % by wt (0...60 °C)
	-02-	HCl 0.00...9.99 % by wt (-20...50 °C)
	-03-	NaOH 0.00...9.99 % by wt (0...100 °C)
	-04-	H ₂ SO ₄ 0.00...9.99 % by wt (-17...110 °C)
	-05-	HNO ₃ 0.00...9.99 % by wt (-20...50 °C)
See graphs in the Appendix, Pg 90		

Sensor standardization

Operating modes	<ul style="list-style-type: none"> • Input of cell constant with simultaneous display of conductivity and temperature • Input of conductivity of calibration solution with simultaneous display of cell constant and temperature • Product calibration • Temperature probe adjustment
-----------------	---

Adm. cell constant 00.0050 ... 19.9999 cm⁻¹

Sensor monitoring

Sensocheck Polarization detection and monitoring of cable capacitance

Sensoface Provides information on the sensor condition (Sensocheck)

Sensor monitor Direct display of measured values from sensor for validation (resistance/temperature)

Temperature input * Pt100/Pt1000/NTC 30 kΩ/NTC 8.55 kΩ (Betatherm) 2-wire connection, adjustable

Measuring range Pt 100/Pt 1000 -20.0 ... +200.0 °C (-4...+392 °F)

NTC 30 kΩ -20.0 ... +150.0 °C (-4...+302 °F)

NTC 8.55 kΩ -10.0 ... +130.0 °C (+14...+266 °F)

Resolution 0.1 °C / 0.1 °F

Meas. error^{1,2,3)} < 0.5 K (< 1K for Pt100; < 1K for NTC > 100°C)

Specifications

Temperature compensation (reference temp 25°C)	(OFF) (Lin) (NLF) (nACL) (HCL) (nH3)	Without Linear characteristic 00.00 ... 19.99 %/K Natural waters to EN 27888 Ultrapure water with NaCl traces (0...120°C) Ultrapure water with HCl traces (0...120°C) Ultrapure water with NH ₃ traces (0...120°C)
Output 1		0/4 ... 20 mA, max. 10 V, floating (galvanically connected to output 2)
Process variable*		Conductivity, resistivity, concentration, salinity
Overrange *		22 mA in the case of error messages
Output filter *		Low-pass, filter time constant 0 ... 120 s
Measurement error ¹⁾		< 0.3% current value + 0.05 mA
Start/end of scale		As desired within range
Minimum span		5 % of selected range
Output 2		0/4 ... 20 mA, max. 10 V, floating (galvanically connected to output 1)
Process variable		Temperature
Overrange *		22 mA in case of temp error messages
Output filter *		Low-pass, filter time constant 0 ... 120 s
Measurement error ¹⁾		< 0.3% current value + 0.05 mA
Start/end of scale *		-20 ... 300 °C / -4 ... 572 °F
Admissible span		20 ... 320 K / 36 ... 576 °F
Alarm contact		Relay contact, floating
Contact ratings		AC < 250 V / < 3 A / < 750 VA DC < 30 V / < 3 A / < 90 W
Contact response		N/C (fail-safe type)
Alarm delay		10 s

Limit values	Output via relay contact
Contact ratings	AC < 250 V / < 3 A / < 750 VA DC < 30 V / < 3 A / < 90 W
Contact response*	N/O or N/C
Delay *	0000 ... 9999 s
Setpoints*	As desired within range
Hysteresis*	0 ... 50 % full scale
Cleaning function	Relay contact, floating, for controlling a simple rinsing system or an automatic cleaning system
Contact ratings	AC < 250 V / < 3 A / < 750 VA DC < 30 V / < 3 A / < 90 W
Contact response	N/C or N/O
Rinse interval	000.0 ... 999.9 h (000.0 h = cleaning function switched off)
Rinse duration	0000 ... 1999 s
Display	LC display, 7-segment with icons
Main display	Character height 17 mm, unit symbols 10 mm
Secondary display	Character height 10 mm, unit symbols 7 mm
Sensoface	3 status indicators (friendly, neutral, sad face)
Mode indication	4 mode indicators "meas", "cal", "alarm", "config" Further icons for configuration and messages
Alarm indication	Red LED in case of alarm
Keypad	5 keys: [cal] [conf] [▶] [▲] [enter]
Service functions	
Current source	Current specifiable for output 1 and 2 (00.00 ... 22.00 mA)
Device self-test	Automatic memory test (RAM, FLASH, EEPROM)
Display test	Display of all segments

Specifications

Last Error	Display of last error occurred
Sensor monitor	Display of direct sensor signal (resistance/temperature)
Data retention	Parameters and calibration data > 10 years (EEPROM)
Protection against electric shock	Protective separation of all extra-low-voltage circuits against mains by double insulation to EN 61010-1
Power supply	24 (-15%)...230 V AC/DC (+10%); appr. 5 VA, 2.5 W AC: 45 ... 65 Hz Overvoltage category II, protection class II
Nominal operating conditions	
Ambient temperature	-20 ... +55 °C / -4 ... +131 °F
Transport/Storage temp	-20 ... +70 °C / -4 ... +158 °F
Relative humidity	10...95 % not condensing, maximum operating height 2000 m
Power supply	24 (-15%) ... 230 V AC/DC (+10%)
Frequency for AC	45 ... 65 Hz
EMC	
Emitted interference	EN 61326-1, EN 61326-2-3 Class B (residential area) Class A for mains > 60 V DC
Immunity to interference	Industry
Explosion protection	
FM	NI Class I Div 2 Group A, B, C & D, T4 Ta = 55 °C; Type 2 NI Class I Zone 2 Group IIC, T4 Ta = 55°C; Type 2

Housing	Molded enclosure made of PBT, glass bead reinforced
Color	Black
Mounting	<ul style="list-style-type: none">• Wall mounting• Pipe mounting: Ø 40 ... 60 mm □ 30 ... 45 mm• Panel mounting, cutout to DIN 43 700 Sealed against panel
Dimensions	H 144 mm, W 144 mm, D 105 mm
Ingress protection	IP 65 / NEMA 4X
Cable glands	3 knockouts for cable glands M20x1.5 2 knockouts for NPT 1/2" or rigid metallic conduit
Weight	Approx.1 kg

* User-defined

1) To IEC 746 Part 1, at nominal operating conditions

2) ± 1 count

3) Plus sensor error

Calibration Solutions

Potassium Chloride Solutions (Conductivity in mS/cm)

Temperature	Concentration ¹⁾		
°C	0.01 mol/l	0.1 mol/l	1 mol/l
0	0.776	7.15	65.41
5	0.896	8.22	74.14
10	1.020	9.33	83.19
15	1.147	10.48	92.52
16	1.173	10.72	94.41
17	1.199	10.95	96.31
18	1.225	11.19	98.22
19	1.251	11.43	100.14
20	1.278	11.67	102.07
21	1.305	11.91	104.00
22	1.332	12.15	105.94
23	1.359	12.39	107.89
24	1.386	12.64	109.84
25	1.413	12.88	111.80
26	1.441	13.13	113.77
27	1.468	13.37	115.74
28	1.496	13.62	
29	1.524	13.87	
30	1.552	14.12	
31	1.581	14.37	
32	1.609	14.62	
33	1.638	14.88	
34	1.667	15.13	
35	1.696	15.39	
36		15.64	

1) Data source: K. H. Hellwege (Editor), H. Landolt, R. Börnstein: Zahlenwerte und Funktionen ..., volume 2, part. volume 6

2) Data source: Test solutions calculated according to DIN IEC 746-3

Sodium Chloride Solutions (Conductivity in mS/cm)

Temperature	Concentration		
°C	0.01 mol/l ⁽²⁾	0.1 mol/l ⁽²⁾	Saturated ⁽¹⁾
0	0.631	5.786	134.5
1	0.651	5.965	138.6
2	0.671	6.145	142.7
3	0.692	6.327	146.9
4	0.712	6.510	151.2
5	0.733	6.695	155.5
6	0.754	6.881	159.9
7	0.775	7.068	164.3
8	0.796	7.257	168.8
9	0.818	7.447	173.4
10	0.839	7.638	177.9
11	0.861	7.831	182.6
12	0.883	8.025	187.2
13	0.905	8.221	191.9
14	0.927	8.418	196.7
15	0.950	8.617	201.5
16	0.972	8.816	206.3
17	0.995	9.018	211.2
18	1.018	9.221	216.1
19	1.041	9.425	221.0
20	1.064	9.631	226.0
21	1.087	9.838	231.0
22	1.111	10.047	236.1
23	1.135	10.258	241.1
24	1.159	10.469	246.2
25	1.183	10.683	251.3
26	1.207	10.898	256.5
27	1.232	11.114	261.6
28	1.256	11.332	266.9
29	1.281	11.552	272.1
30	1.306	11.773	277.4
31	1.331	11.995	282.7
32	1.357	12.220	288.0
33	1.382	12.445	293.3
34	1.408	12.673	298.7
35	1.434	12.902	304.1
36	1.460	13.132	309.5

Concentration Curves

-01- Sodium chloride solution NaCl

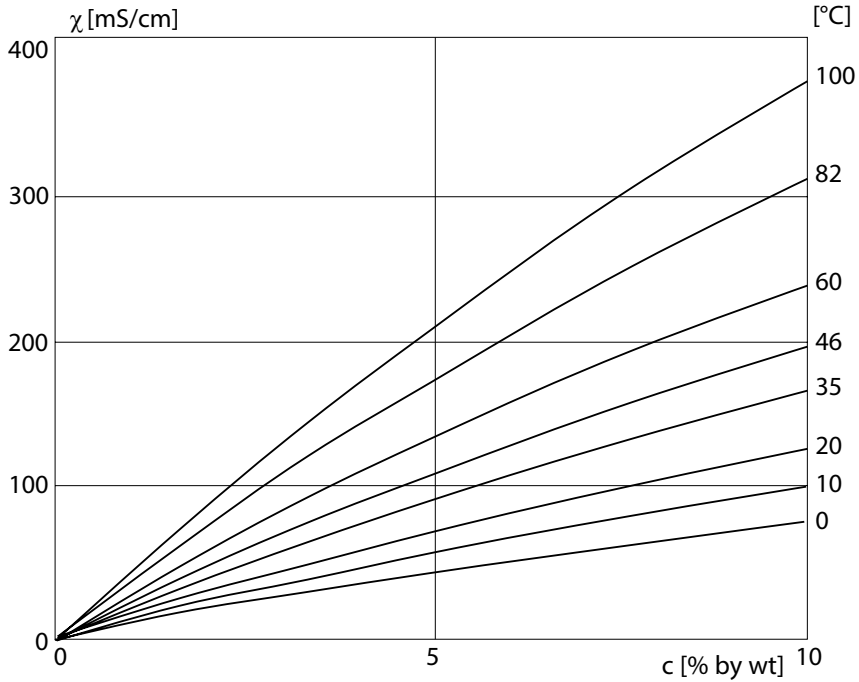

Conductivity versus substance concentration and process temperature for sodium chloride solution (NaCl)

-02- Hydrochloric acid HCl

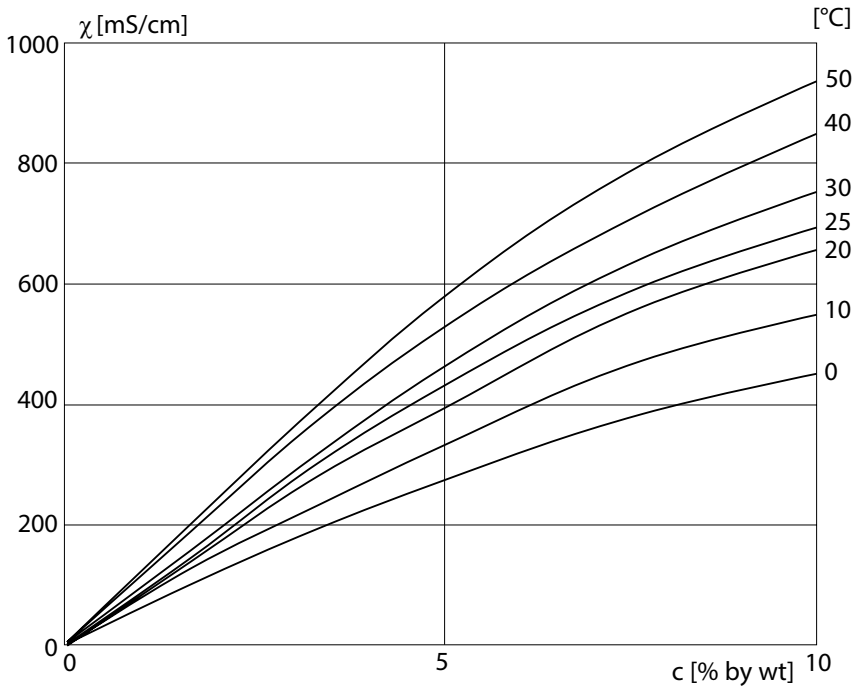

Conductivity versus substance concentration and process temperature for hydrochloric acid (HCl)

Source: Haase/Sauermann/Dücker; Z. phys. Chem. New Edition, Vol. 47 (1965)

-03- Sodium hydroxide solution NaOH

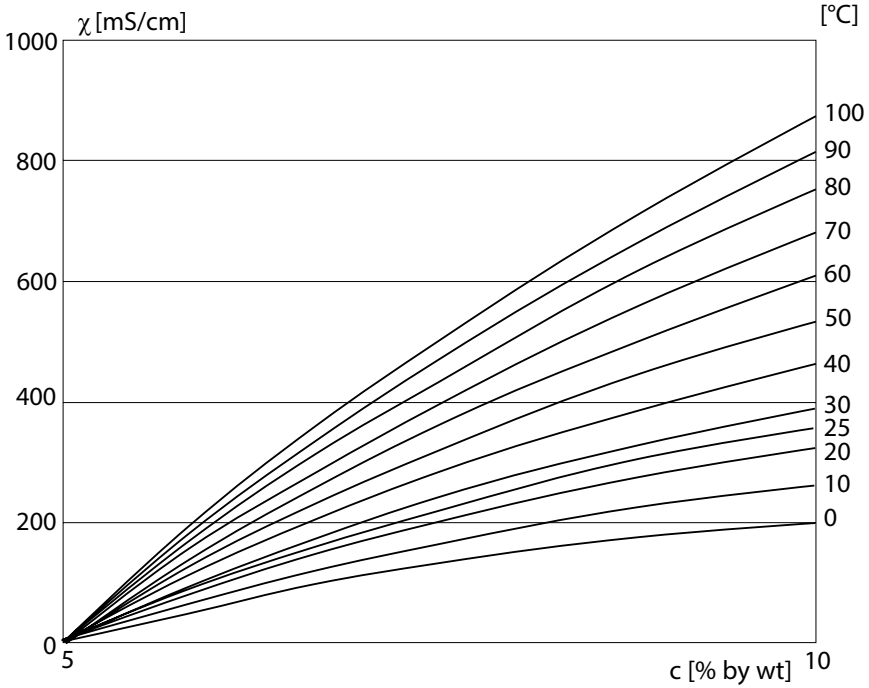

Conductivity versus substance concentration and process temperature for sodium hydroxide solution (NaOH)

-04- Sulfuric acid H_2SO_4

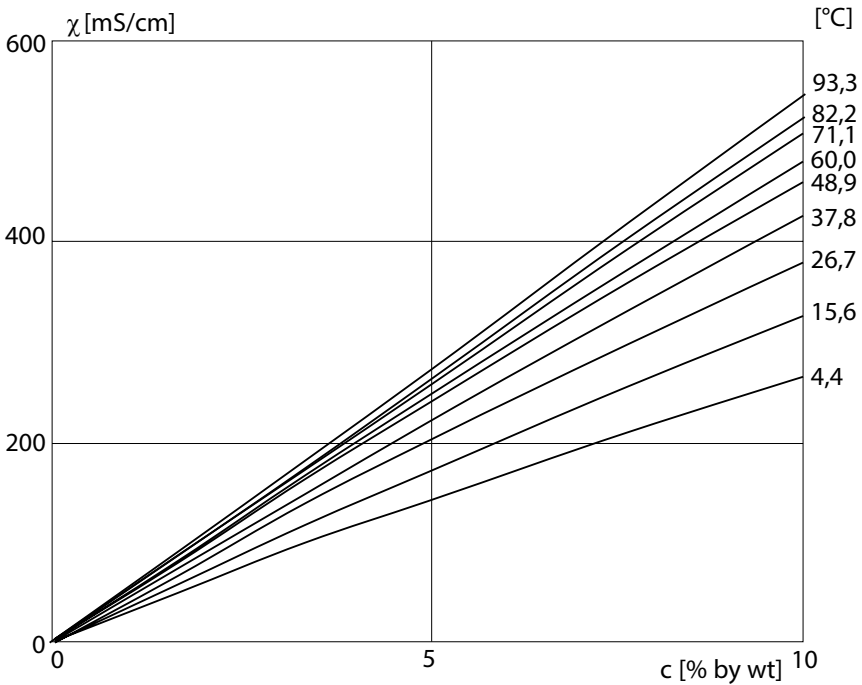

Conductivity versus substance concentration and process temperature for sulfuric acid (H_2SO_4)

Source: Darling; Journal of Chemical and Engineering Data; Vol.9 No. 3, July 1964

-05- Nitric acid HNO_3

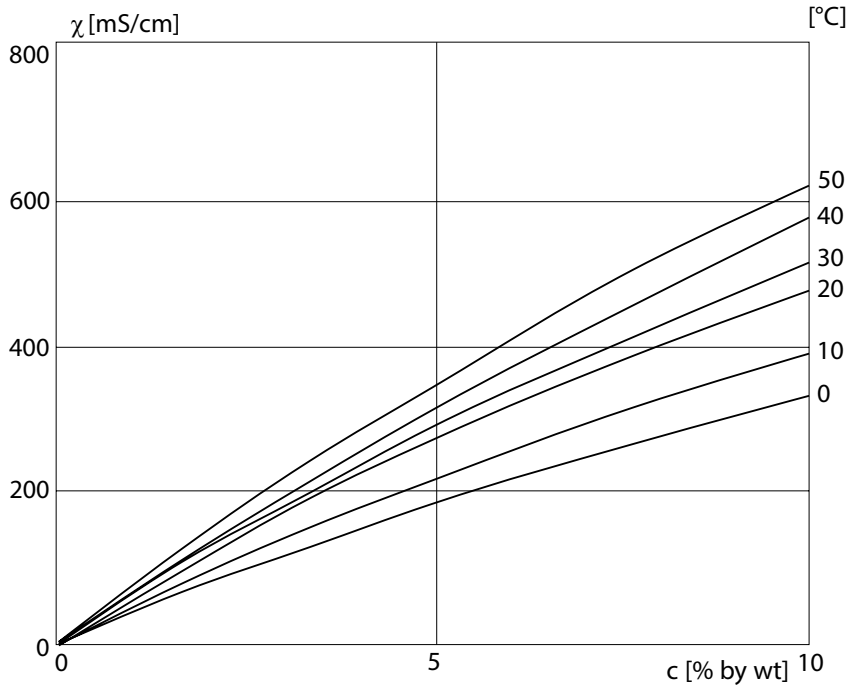

Conductivity versus substance concentration and process temperature for nitric acid (HNO_3)

Source: Haase/Sauermann/Dücker; Z. phys. Chem. New Edition, Vol. 47 (1965)

Conductance	Conductance $G [S] = 1 / R [\Omega]$
Conductivity	Conductivity $\chi [S/cm] = G [S] \cdot c [1/cm]$
Conductivity sensor	<p>Either 2- or 4-electrode sensors can be connected. The cell constant of the sensor in use must be entered or be determined using a calibration solution taking account of the temperature.</p> <p>A special device variant (Stratos Eco 2405 CondI) is provided for electrodeless sensors.</p>
Passcode	Preset four-digit number to select certain functions.
Sensocheck	Sensocheck monitors the sensor and its wiring. The resulting information is indicated by the Sensoface smileys. Sensocheck can be switched off.
Sensoface	Provides information on the sensor condition. Significant sensor polarization effects or an excessive cable capacitance are indicated..
Temperature coefficient	With temperature compensation activated, the measured value is calculated to the value at the reference temperature (25 °C) using the temperature coefficient.
Temperature compensation	Calculates the measured conductivity value for a reference temperature.

Safe Operation

Warnings and Notes to Ensure Safe Operation

WARNING!

Do not disconnect equipment unless power has been switched off.

CAUTION!

Clean only with antistatic moistened cloth.

CAUTION!

Substitution of components may impair suitability for hazardous locations.

- The equipment shall be installed and protected from mechanical impact and ultraviolet (UV) sources.
- Clean only with a moistened antistatic cloth as potential electrostatic hazard may exist. Service equipment only with conductive clothing, footwear and personal grounding devices to prevent electrostatic accumulation.
- Internal grounding provisions shall be provided for field wiring. Bonding between conduit shall be provided during installation, and all exposed non-current carrying metallic parts shall be bonded and grounded.
- The equipment shall have a switch or circuit breaker in the building installation (that is in close proximity to the equipment) that is marked as the disconnect switch.
- The enclosure Type 2 is only for indoor use.
- The mains supply voltage fluctuations should not exceed -15/+10 percent of the nominal supply voltage.
- The device shall not be used in a manner not specified by this manual.

CAUTION!

Use supply wires suitable for 30 °C / 86 °F above ambient and rated at least 250 V.

CAUTION!

Use signal wires suitable for at least 250V.

Index

22 mA signal for error message 45, 51

A

Accessories 81

Alarm contact 55, 84

Alarm settings 29, 54

Assembly 10

C

Calibration 64

by entry of cell constant 66

Product calibration 70

Temp probe adjustment 72

with calibration solution 68

Calibration solutions 88

Cal Info 73

“Clean” contact 58

Concentration curves 90

Hydrochloric acid HCl 91

Nitric acid HNO₃ 94

Sodium chloride solution NaCl 90

Sodium hydroxide solution NaOH 92

Sulfuric acid H₂SO₄ 93

Concentration measurement 39

Configuration 30

Menu structure 31

Configuration: Alarm settings 54

Configuration: Limit function 56

Configuration: Output 1

Concentration measurement 38

Output current during Error and HOLD 44

Output current range 40

Output filter 42

Process variable 36

Sensor type 34

Configuration: Output 2

Output current 46

Output current during HOLD 50

Output filter 48

Temperature 46

Temperature error 50

Configuration: Rinsing probes 58

Configuration: Temperature compensation 52

Connection 14

Current start / end 41, 47

D

Default settings 60

- Device self-test 27
- Diagnostics functions 73
 - Display of calibration data 73
 - Display of last error message 73
 - Display of output currents 73
 - Sensor monitor 73
 - Specifying the output current 74
- Display 25
- Disposal 2
- Division 2 wiring 15
- Documentation 8

E

- Error Info 73
- Error messages 75
 - Display of last error message 73
- Explosion protection 86

F

- Factory settings of parameters 60
- Front panel 24

G

- Glossary 95

H

- Hold mode 28
- HOLD mode
 - Output signal during HOLD 45, 51
- Hysteresis 57

I

- Installation 14
- Intended use 7

K

- Keypad 26

M

- Measurement 72
- Mounting plan 11

O

- Operating states 77
- Output filter 42, 48
- Overview 9
- Overview of configuration steps 32

P

- Package contents 10
- Panel mounting 13
- Panel-mount kit 13

Index

Parameters

- Factory settings 60
- Individual settings 62

- Passcodes 103
- Pipe mounting 12
- Pipe-mount kit 12
- Product calibration 70
- Product line 81
- Protective hood 12
- Protective wiring 22

Q

- Quickstart guides 8

R

- Relay 56, 58
- Relay contacts 22
- Rinse contact 58
- Rinsing interval 59
- Rinsing probes 58
- Rinsing system 59

S

- Safe Operation 96
- Safety information 5, 96
- Self-test 27
- Sensocheck 27, 54, 78
 - Configuration 55
- Sensoface 27, 78
- Sensor connection 16
- Sensor monitor 73
- Short instructions 8
- Specifications 82

T

- Technical data 82
- Temperature compensation 52
- Temperature measurement, configuration 47
- Temperature probe adjustment 72
- Terminal assignments 14
- Time constant of output filter 43, 49
- Trademarks 7

U

- User interface 24

W

- Wiring examples 16

Passcodes

Calibration

Key + passcode	Menu item	Page
cal + 0000	CAL info (display of cell constant)	73
cal + 0110	Calibration (with standard solution)	68
cal + 1100	Cell constant adjustment	66
cal + 1105	Product calibration	70
cal + 1015	Temp probe adjustment	72

Configuration

Key + passcode	Menu item	Page
conf + 0000	Error info (display of last error, erase)	73
conf + 1200	Configuration	30
conf + 2222	Sensor monitor (resistance, temp)	73
conf + 5555	Current source 1 (specify output current)	74
conf + 5556	Current source 2 (specify output current)	74
conf + ▶ + 4321	Factory setting	60



Knick
Elektronische Messgeräte
GmbH & Co. KG

Headquarters

Beuckestraße 22 • 14163 Berlin

Germany

Phone: +49 30 80191-0

Fax: +49 30 80191-200

info@knick.de

www.knick.de

Local Contacts

www.knick-international.com

Copyright 2020 • Subject to change

Version: 5

This document was last updated on Nov. 16, 2020

The latest documents are available for download on our website
under the corresponding product description.

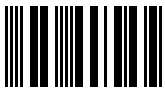

097798