

Precision Devices For the Railway Industry



**THE ART
OF MEASURING**

The Knick Group has been a proven partner of the international railway industry for more than 50 years.





> Why Knick?

Signal conditioners and transmitters from Knick deliver the signals required for downstream processes – interference-free and with high precision at all times. The precise, robust devices from Knick meet the rail industry's special standards-related and functional requirements.

And to us, precision also means that each individual product property is perfectly tuned to the measurement task. After all, this is the prerequisite for the overall system being able to reliably carry out its function.





Knick Core Competences

-  Galvanic Isolation
-  Voltage Measurement
-  Current Measurement
-  Speed Signal Conditioning
-  Temperature Measurement at High Voltage

 **Voltage Measurement in DC Substations**
 For 750 V, 1500 V and 3000 V DC systems
 Continuous Isolation up to 3600 V AC/DC
 Test Voltage up to 15 kV AC
[More on Page 6](#)

 **Current Measurement in DC Substations**
 For up to 20 kA with Shunt Resistors from ±30 mV
 Continuous Isolation up to 3600 V AC/DC
 Test Voltage up to 15 kV AC
[More on Page 6](#)

 **Temperature Measurement in DC Substations**
 With Pt100 Resistance Thermometer (RTD)
 Continuous Isolation up to 6600 V AC/DC
 Test Voltage up to 15 kV AC
[More on Page 11](#)

 **Voltage Measurement on Rolling Stock**
 Up to ±4500 V DC / ±3000 V AC
 Continuous Isolation up to 4800 V AC/DC
 Test Voltage up to 20 kV AC
[More on Page 12](#)

 **Current Measurement on Rolling Stock**
 For up to 20 kA with Shunt Resistors from ±30 mV
 Continuous Isolation up to 4800 V AC/DC
 Test Voltage up to 18 kV AC
[More on Page 14](#)

 **Speed Signals on Rolling Stock**
 Speed Signal Doubling, Adaptation and Isolation
 Continuous Isolation up to 1000 V AC/DC
 Test Voltage up to 5 kV AC
[More on Page 16](#)

Knick Group

Railway Technology Worldwide

Reliability for your rail systems made in Germany.

Knick is a reliable partner that has always been known for achieving high technological levels and constantly striving for innovation. One in four Knick employees works in the Research & Development department.

Based on its many years of experience in developing interface technology for a spectrum of sectors such as power generation, energy storage, steel processing, etc., Knick provides top quality that is mature down to the details and maximum product reliability and service life.

Alongside its headquarters in Berlin, Knick has subsidiaries in the US, China, Korea, Switzerland and France. Knick is represented by partners in 39 other countries.

The Knick service team would be happy to explain further details on measuring devices for rolling stock and infrastructure.

Phone: +49 30 80191-0

E-Mail: info@knick.de



● Knick Group

○ Sales Partner

High Isolation Transducers for Voltage, Current, Temperature and Speed Signals

In Rolling Stock and Wayside Applications

Knick Elektronische Messgeräte GmbH & Co. KG – Family-owned company with high quality standards.

With an exceptionally high MTBF of 2165 years (Mean Time Between Failures) in DC high-voltage transducers, which was determined based on real field data, Knick has set an industry benchmark.

This quality standard is also pursued for all other products for the railway industry by the 250+ employees in the Berlin, Germany, Headquarters and in their international subsidiaries.

On this basis, Knick supplies pioneering measuring technology that increases cost-effectiveness and safety in rail transport – on track and in DC traction power supply. With devices for precise measurement of current, voltage and temperature, as well as for isolated signal conversion for the railway sector, Knick impressively demonstrates:

THE ART OF MEASURING

Precision and Reliability – Made in Germany



Pioneering

New standards developed through experience and know-how – Our driving force then and now.



Performance

Optimal solutions for demanding conditions – Application challenges welcomed.



Precision

Sophisticated technology and meticulous verification – Accuracy is our target.



Premium Quality

First-rate materials and outstanding reliability – Delivery of excellent products is our promise.

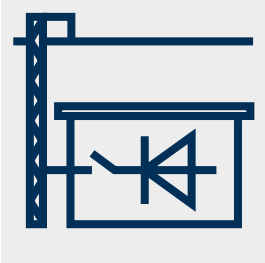

The Reliable Market Leader: The P40000 Product Series

Voltage, Current and Temperature Measurement In DC Traction Power Supply

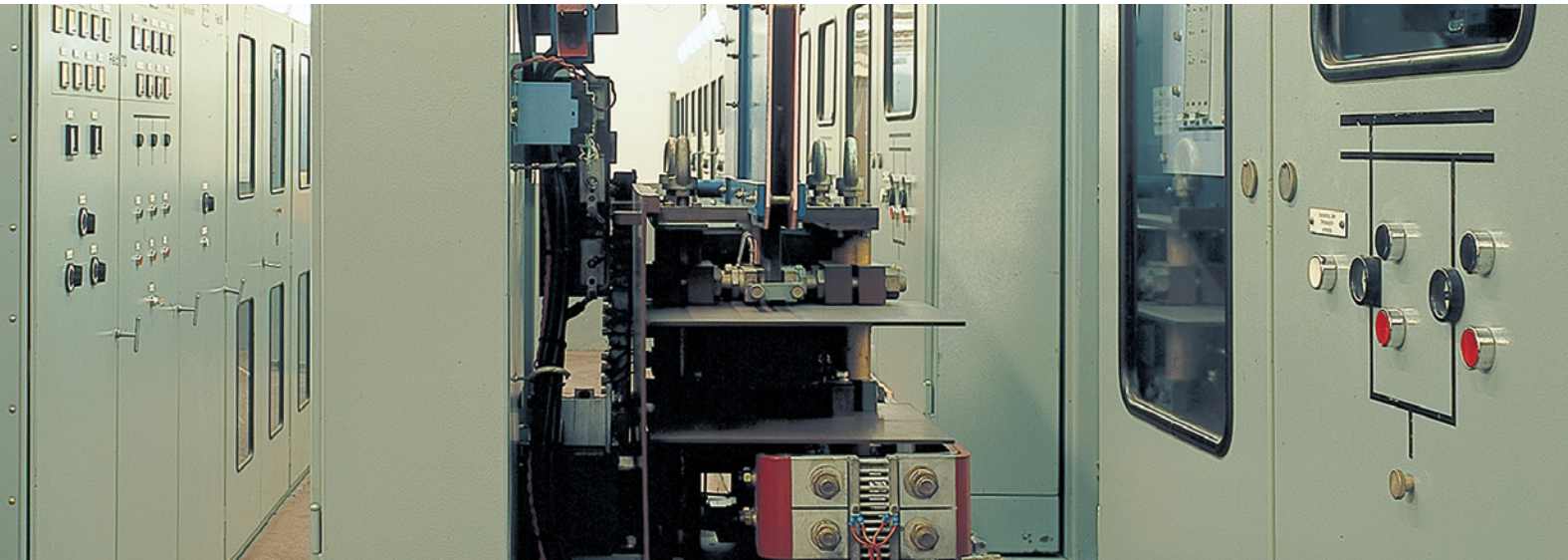

For the reliable and precise measurement of voltage and current in DC substations, Knick has been supplying galvanically isolated measuring transducers for decades. During this time, it has become the global market leader in this field. Therefore, Knick is also the first contact for suppliers and operators of DC substation technology when special technical challenges need to be mastered, e.g. possibilities of wear monitoring for predictive maintenance.

Substations for DC power supply have rated powers as high as the upper single-digit MW range. Substations and the grid sections they supply must be effectively safeguarded against short circuits. The protection mechanism must reliably interrupt high levels of current as quickly as possible, limiting the power that flows into the short circuit.

The protective device must measure current and voltage in order to execute algorithms for short-circuit detection. This requires high voltage transducers that measure quickly and precisely while withstanding high loads. They must master voltages between 750 and 3000 V DC, including temporary surges in the case of energy recovery for braking trains, for example.

Within these high voltage applications, the protection of people and equipment is critical. Therefore, the strong galvanic isolation exhibited by the Knick devices makes for an important consideration during transducer selection. The universal high voltage transducers P41000 and P42000 have proven their value in DC traction power supply substations worldwide.

P41000

0 ... (±)50 mV
...
0 ... (±)100 V

In

Out

4 ... 20 mA
or
0 ... (±)20 mA
or
0 ... (±)10 V

Power

22 ... 230 V AC/DC

P41000 – Current Measurement via Shunt Resistor

The protective device must measure current and voltage in order to execute algorithms for short-circuit detection. This requires high voltage transducers that measure quickly and precisely while withstanding high loads. They must master voltages between 750 and 3000 V DC, including temporary surges in the case of energy recovery for braking trains, for example.

Application:

- Bidirectional current measurement for
- Control and protection relays
 - Switch disconnector panels (Incomer panels, negative return feeders)
 - Circuit breaker panels (Line and bypass feeders)
 - Voltage limiting devices
 - Frame fault detection
 - Line testing

P42000

0 ... (±)100 V
...
0 ... (±)3600 V

In

Out

4 ... 20 mA
or
0 ... (±)20 mA
or
0 ... (±)10 V

Power

22 ... 230 V AC/DC

P42000 – Voltage Measurement

Universal high voltage transducers for direct measurement of high voltages. High measurement accuracy without long-term drift.

Application:

- Unipolar and bipolar voltage measurement for
- Control and protection relays
 - Switch disconnector panels (Incomer panels, negative return feeders)
 - Circuit breaker panels (Line and bypass feeders)
 - Voltage limiting devices
 - Stray current supervision
 - Frame fault detection

New Product

P41000AG – Current and Overcurrent Measurement

Two-in-one: Adaptive gain for nominal current and overcurrent measuring. High accuracy in the nominal current range, sufficient accuracy for up to 11 times of nominal current. First of its kind on the market.

Application:

- Bidirectional current measurement at circuit breaker for detection of the short circuit current through protection relays
- High-speed circuit breaker wear monitoring for predictive maintenance

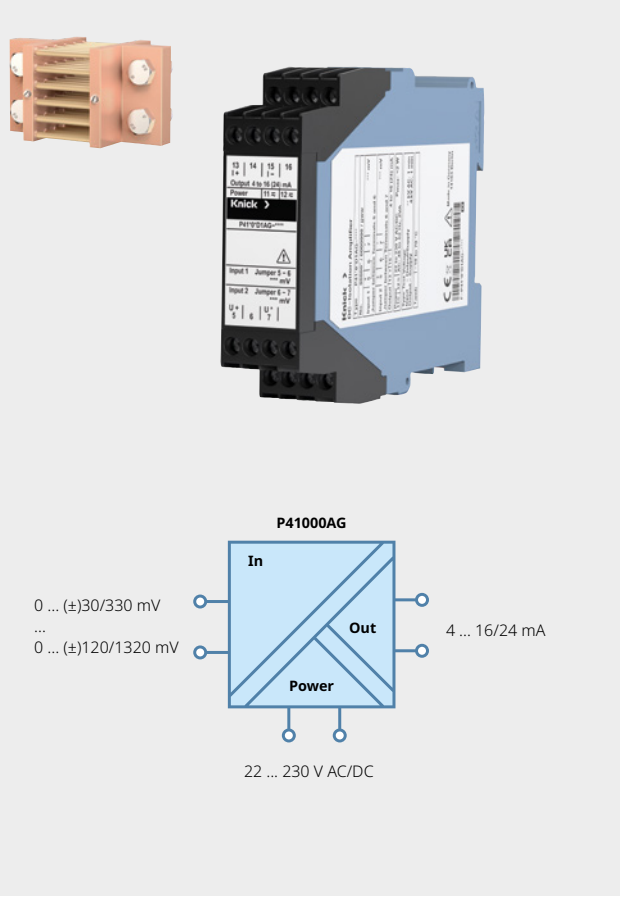

Transfer characteristic P41000AG

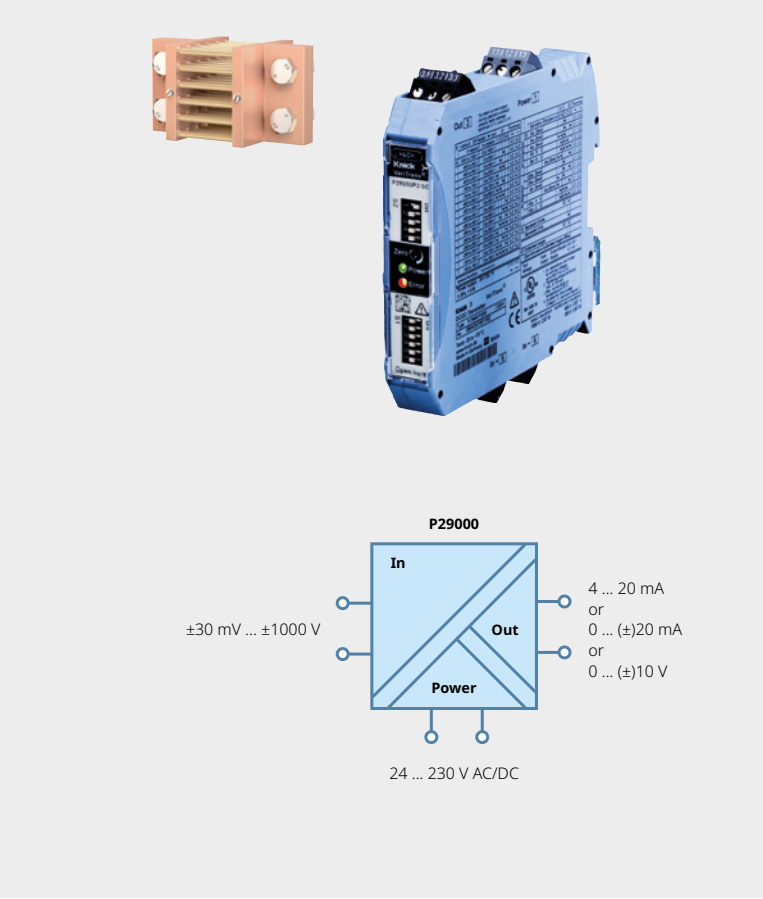
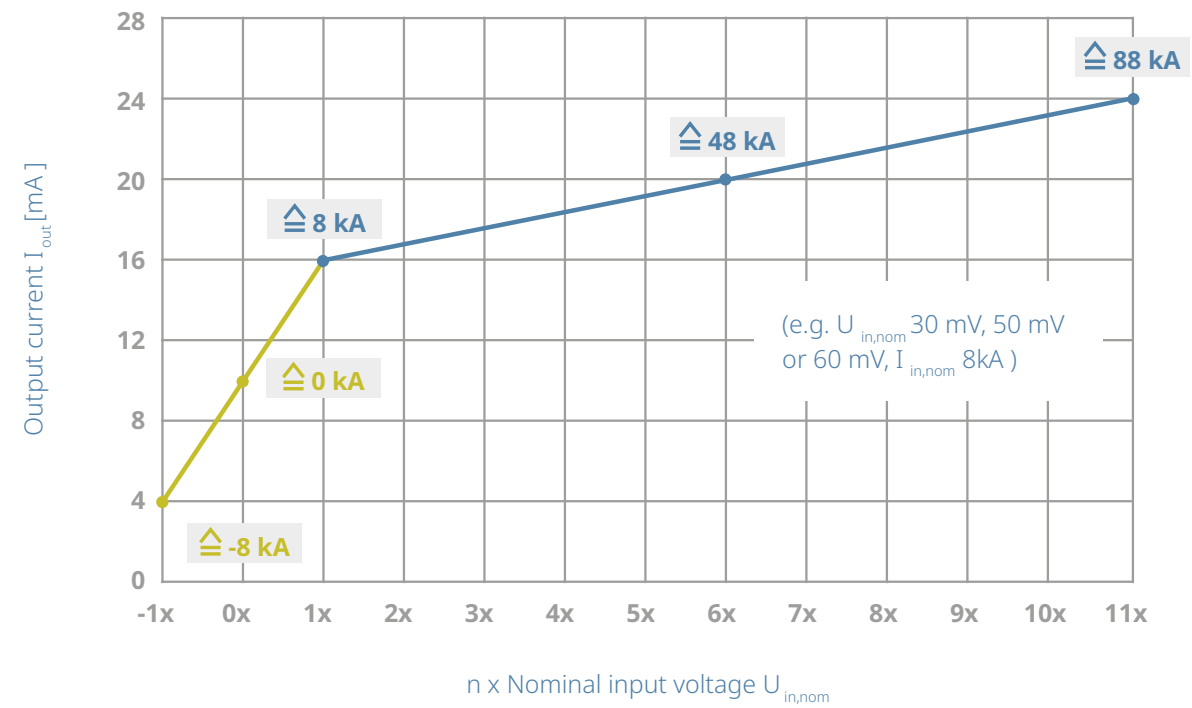

P29000 – Voltage and Current Measurement via Shunt Resistor

High Voltage Transducer for reliable current and voltage measurements with moderate isolation requirements.

Application:

- Bidirectional current measurement
- Unipolar and bipolar voltage measurement
- Slim alternative for "lower" voltage environments

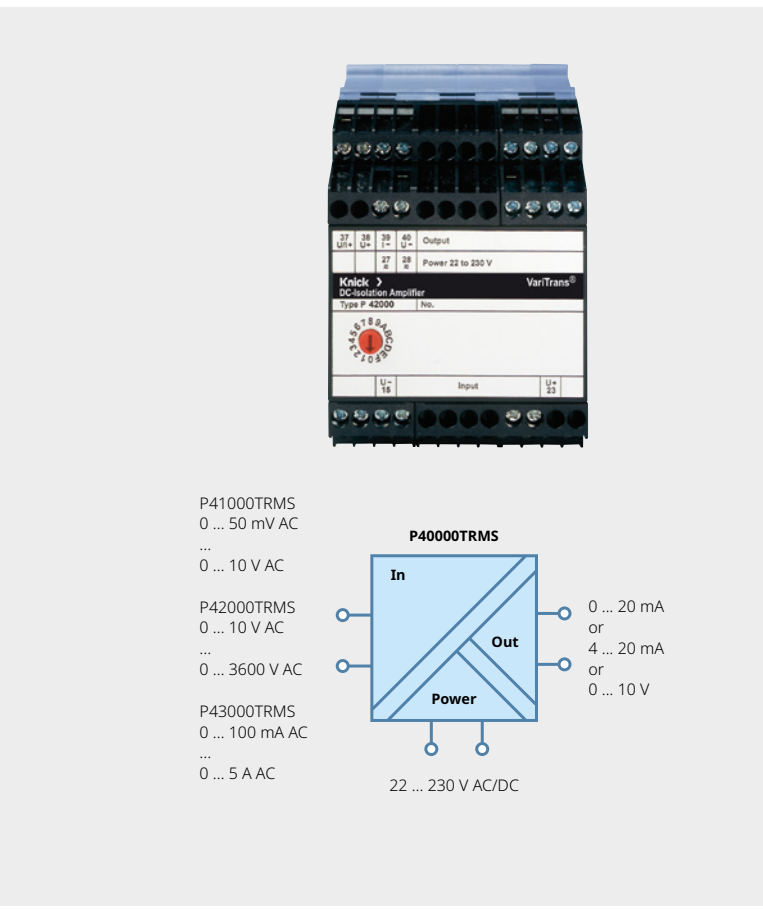

P40000TRMS – AC Voltage and Current TRMS Measurement

AC High Voltage Transducer / signal conditioner for true RMS measurement of voltages and currents from 16.7 Hz to 400 Hz. The output is available as DC signal for example for PLC use. Providing 3600 V isolation and 15000 V test voltage. Compliant to EN 50124.

Application:

- AC Voltage and current supervision in substations, workshops and test stands



P52000VPD – Voltage Presence Detection

P52000VPD is designed to detect voltages between 50 and 4200 V. The input signal is compared to a threshold value and the resulting binary information is galvanically isolated and transmitted to the output circuit. When the input voltage exceeds the set threshold value, a solid state relay opens, signaling the presence of voltage at the input.

Application:

- High voltage presence detection
- in traction power supply
 - on rolling stock
 - for the operation of motorized disconnects (MODs)
 - for the verification of live rail or catenary

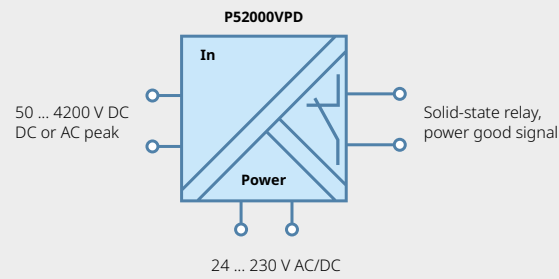

Switching Behavior Relay Output

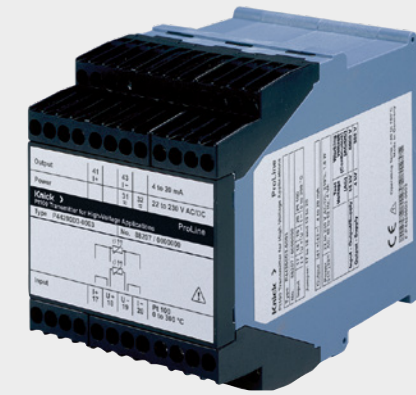
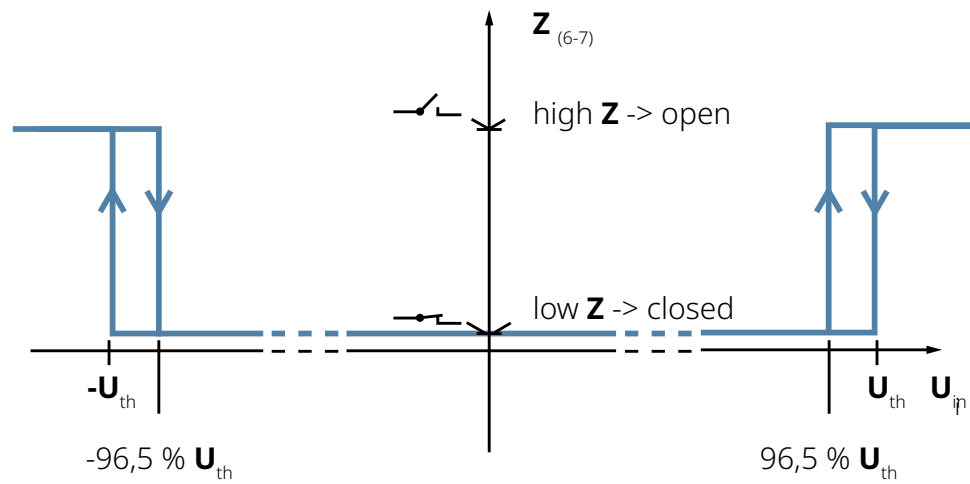

New Product

P44000 – Temperature Measurement

Measurement of up to 300 °C via Pt100 resistance thermometer (RTD). Low measurement error of typically 0.5 K and short T90 delay time of 100 ms. Up to 6600 V AC/DC continuous isolation.

Application:

- Temperature monitoring of thyristors, diodes, IGBTs in rectifiers and inverters
- Temperature monitoring of busbars in switchgears
- Temperature monitoring of heat sinks

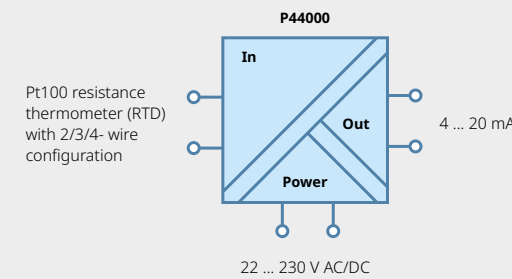

The perfect Solution for any Voltage Level And Rail Standards Requirement



Let us talk about Solutions!





The Most Space Saving High Voltage Transducer For Rolling Stock: The P45000

High Voltage and Current Measurement in Rolling Stock

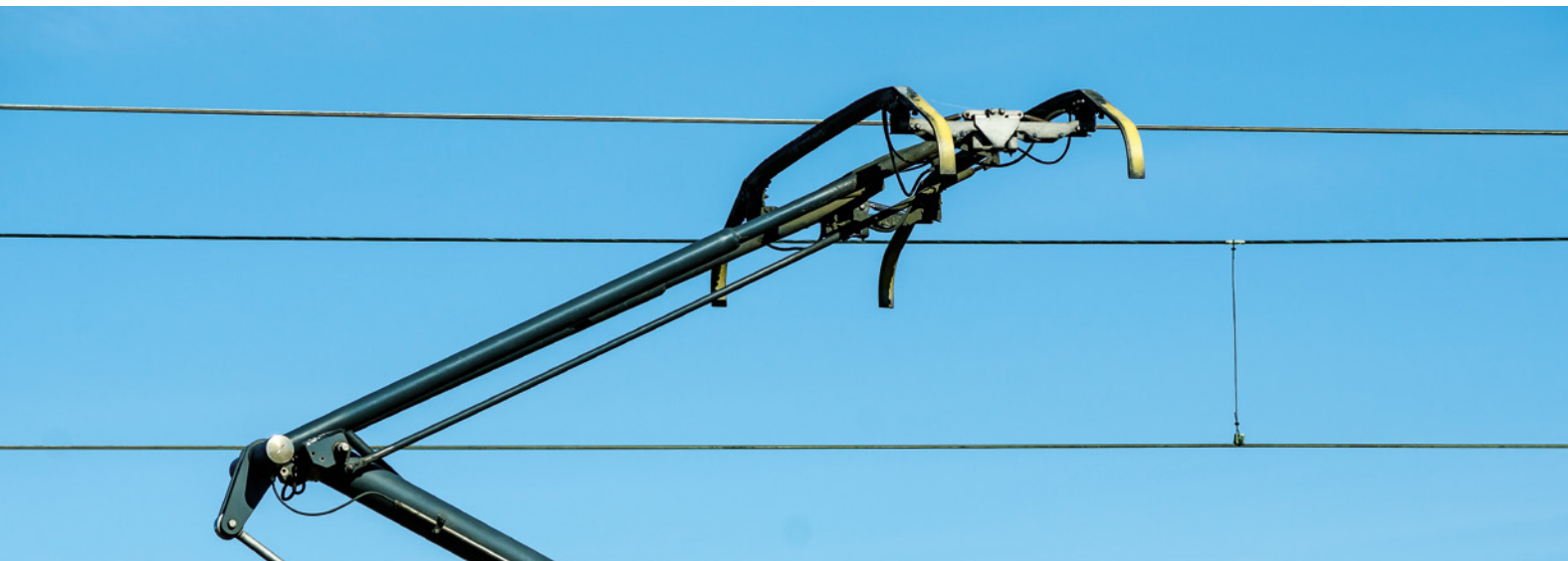

The P45000 series transducers are designed for measuring high DC and AC voltages on heavy vehicles, especially rolling stock. Monitoring and control of traction motors, monitoring of DC link voltage in traction inverters and auxiliary power converters are some application examples.

The voltage measurement input is highly isolated from output and auxiliary power. The current output is compatible with commercially available control inputs. The housing offers flexible mounting options: upright or horizontal screwed or snapped onto 35 mm DIN rails. The devices can even be mounted in a stack, allowing for very tight space requirements.

For the first time, applications with functional safety requirements can be properly carried out. The high-voltage transmitter is certified for use in SIL2 systems and, redundantly, SIL3. Thus, for example, the presence of dangerously high voltages can be reliably detected.

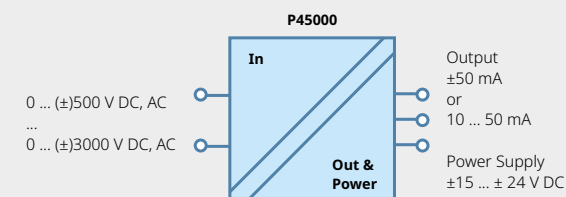

The Compact Specialist

Space saving installation with P45000 compared to conventional voltage transducers

- SIL 2/3 certified functional safety – worldwide first high voltage SIL transducer
- Stackable for minimum space requirements
- Flexible mounting options: DIN rail, flat or upright on a plane

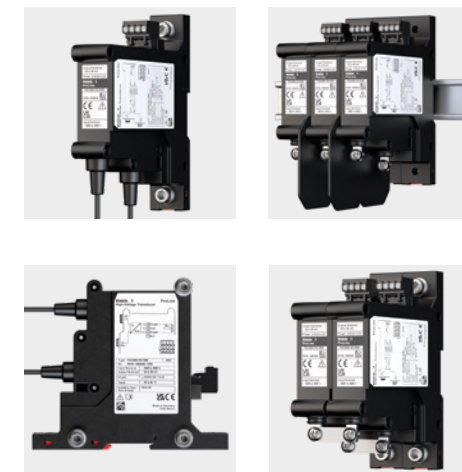

New Product

P45000 – Flexible High Voltage Measurement

High Voltage Transducer optimized for use on all DC and AC-driven rail vehicles including diesel-electric vehicles. The small size supports the miniaturization of drive systems and energy supplies. Mechanical and electrical interfaces according to industrial standards. Multiple variants available concerning accuracy, input voltage and output function ranges.

Application:

- Unipolar and bipolar voltage measurement for
- Traction inverters
 - Auxiliary power converters

i Ready to order with any input voltage range

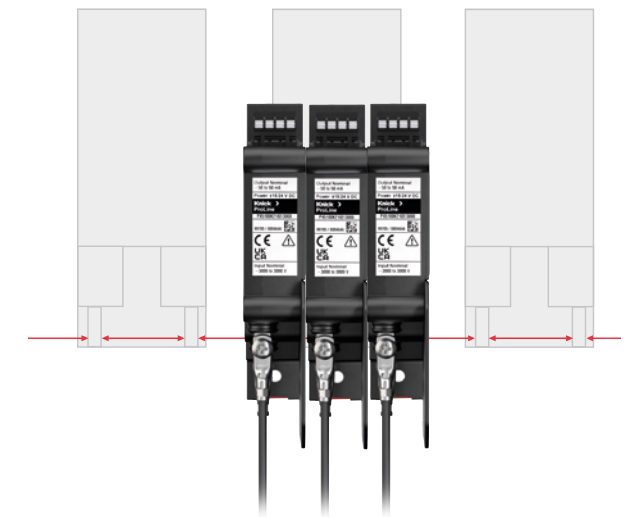

Gray: Set of conventional voltage transducers with required distance between them.

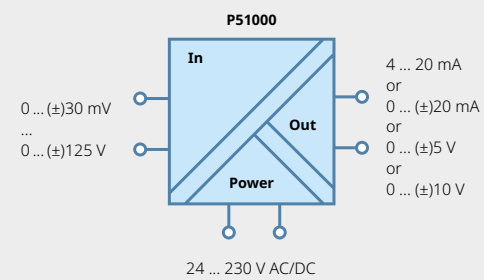
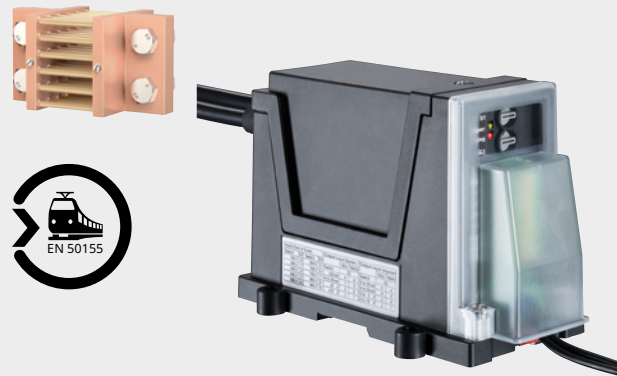

P51000 – Current Measurement via Shunt Resistor

Overload-protected current measurement via shunt resistor from amps to kiloamps. Even strong electromagnetic fields cannot influence the measurement result. This yields highly precise current detection.

Application:

- Bidirectional current measurement for
- Pantograph and current collectors
 - Power distribution boxes
 - Energy Measurement according to EN 50463 (P51000E)

P51000E and P52000E for Energy Measurement according to EN 50463

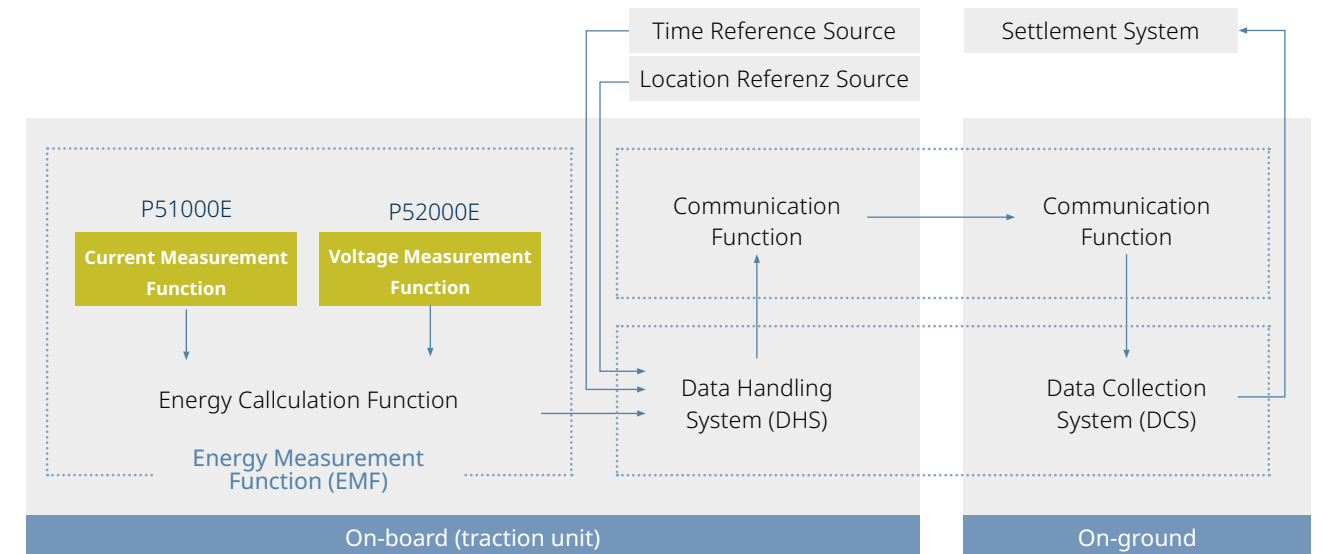

Functional energy measurement system layout and data flowchart in accordance with EN 50463

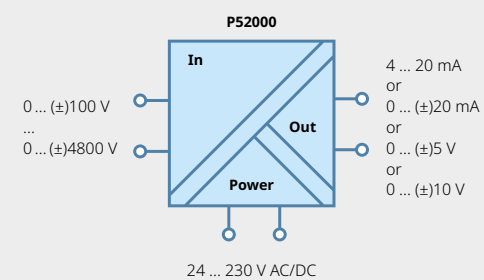

P52000 – Voltage Measurement

High voltage transducer featuring a robust design. High-voltage contacts and connections are encapsulated. There is no danger of interaction with other components. When dimensioning, additional space between junction blocks is no longer needed: P52000 functions with complete safety.

Application:

- Unipolar and bipolar voltage measurement for
- Pantographs and current collectors
 - Power distribution boxes
 - Energy Measurement according to EN 50463 (P52000E)

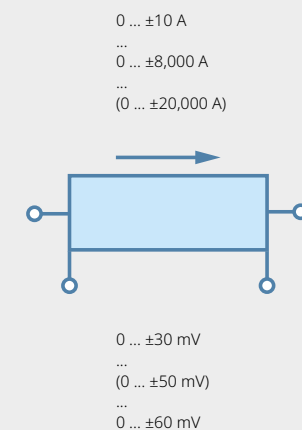
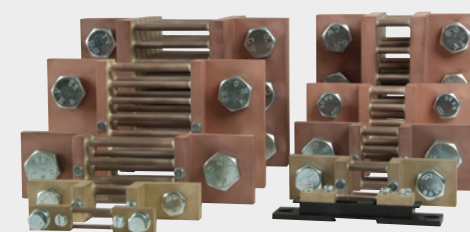

New Product

Shunt Resistor

Precise resistor, providing a low voltage drop which is directly proportional to the flowing current. This principle prevents influences from adjacent lines. Very good long-term stability. High overload capacity without remaining measurement error. Current peaks do not cause any offset or drift. Shunt accuracy Class 0.5, optionally Class 0.2. Available with 30 mV voltage drop to significantly reduce power dissipation and thus heat generation.

Application:

- Bidirectional current measurement in conjunction with a Knick transducer for
- DC traction power supply equipment
 - Rolling stock equipment
 - Energy Measurement according to EN 50463



Simplifies Retrofits, Saves Cost for new Vehicles

Speed Signal Doubling for Rolling Stock



Many systems in and on rolling stock require information on the current speed at any given time. They include brake systems and drive technology, two systems that are key to functional safety. This is why the encoders or sensors providing the speed must function reliably and precisely.

If further on-board applications also require speed information, additional speed encoders are typically mounted on the vehicle axles. However, space is often limited, and installation, including wiring, is an investment in money and time.

With the P16000 Series, Knick provides an extremely simple solution. The signal of an existing speed encoder is decoupled and made available for other applications. The process is non-interacting in accordance with SIL safety level. The speed encoder signal is neither influenced nor interfered with on its way to the control unit.

All common signals from speed sensors with current or voltage output (also with open collector) can be detected. Any output signals can be configured via DIP switches.

The P16800 is the ideal solution for retrofitting rail vehicles. The device helps to quickly and cost-effectively implement the extensive requirements for odometry that result from the adoption and adherence of standardized train control systems.

Cost Saving Solution Certified for Rolling Stock – Odometry without Additional Sensors

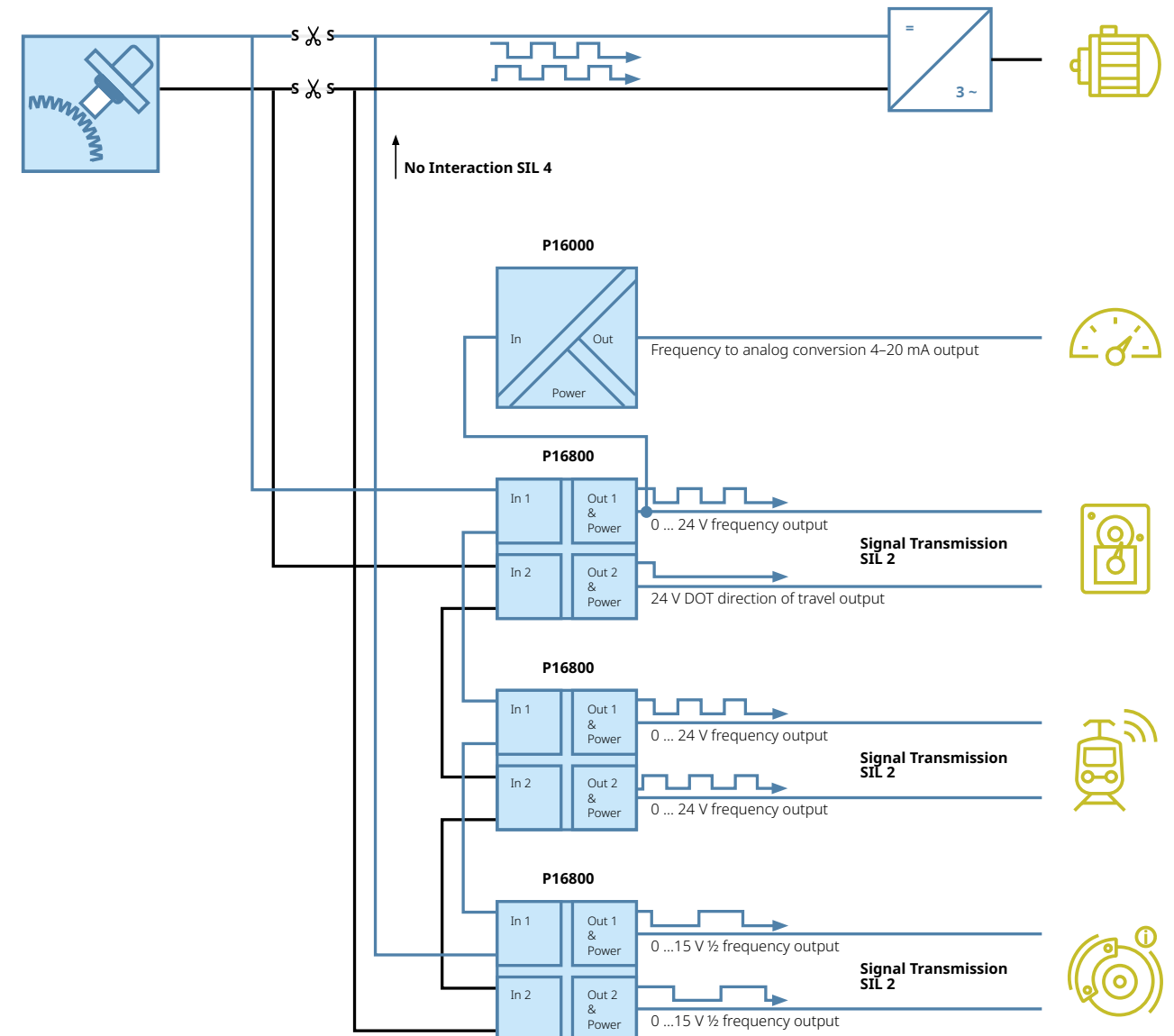

Product Highlight

P16000



P16800



Certified signal doubling for all safety systems

- Providing flexibility in connecting speed sensors with control units
- Simplifies rolling stock upgrades
- SIL 4/SIL 2 (P16800) and SIL 3 (P16000) certified functional safety
- Strong isolation and ultra high EMC immunity

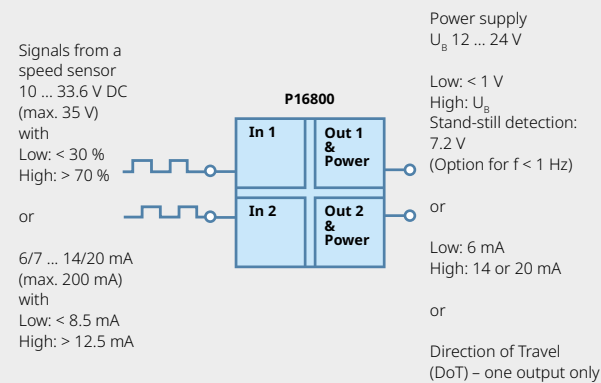

New Product

P16800 – Universal Speed Signal Doubler SIL 2/SIL 4

The use of the P16800 simplifies the retrofitting of rail vehicles with control systems that require speed information, or makes such retrofitting possible in the first place. In new vehicles, the number of speed sensors can be reduced, which optimizes initial and maintenance costs.

Application:

- Saving of speed sensors on rail vehicles due to simply doubling of encoder signals

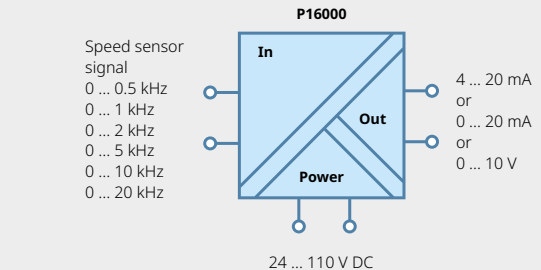









P16000 – Pulse Counter/ Pulse Transmitter SIL 3

Pulse frequency conditioners for decoupling of signals from safety-related circuits and doubling of standard and impulse signals. The speed encoder signal is neither influenced nor interfered with by P16000 on SIL 3 safety level.

Application:

- Measurement of pulse frequency for speed displays on rolling stock

High Voltage Transducers and Signal Conditioners from Knick

Measurement Range	P16000	P16800	P29000	P40000 Series	P45000	P51000 P52000	P44000
Temperature Pt100 (RTD)							
Voltages up to 4800 V/Currents up to 20 kA							
Voltages up to 4500 V							
Voltages up to 3600 V/Currents up to 20 kA							
Voltages up to 1000 V/Currents up to 20 kA							
Frequencies up to 25 kHz							
Frequencies up to 20 kHz							
Continuous Isolation AC/DC (Test Voltage)	300 V (3 kV)	1000 V (8.8 kV)	1000 V (5.4 kV)	3600 V (15 kV)	4800 V (20 kV)	4800 V (18 kV)	6600 V (15 kV)

Subject and Standard		P16000	P16800	P29000	P40000 Series	P45000	P51000 P52000	P44000
Use on rolling stock	EN 50155	X	X			X	X	
Fire protection	EN 45545-1, EN 45545-2, EN 45545-5	X	X			X	X	
Isolation coordination railway application	EN 50124-1/IEC 62497-1	X	X		X	X	X	X
Isolation coordination general industry	UL 347 or UL 61010-1 or EN 50178	X	X	X	X	X	X	X
Protection against electric shock through reinforced insulation	EN 61140 or EN 50178 or EN 50124-1/IEC 62497-1	X	X	X	X	X	X	X
Electrical safety	EN 61010-1	X	X	X	X	X	X	
Reliability	EN 61709 (SN 29500)	X	X	X	X	X	X	X
Climatic conditions	EN 50125-1, EN 50125-3	X	X			X	X	
Resistance to vibration and mechanical shock (rail applications)	EN 61373	X	X		X	X	X	
EMC for rail applications	EN 50121-1, EN 50121-3-2	X	X			X	X	
EMC for industrial applications	EN 61326-1	X	X	X	X	X	X	X
Protective measures with regard to electrical hazards	EN 50153					X	X	
Functional Safety	EN IEC 61508 or EN 50129	X	X			X		

Interface Technology

- > High Voltage Transducers
- > Isolated Signal Conditioners
- > Sensor Transmitters
- > Signal Multipliers
- > Digital Indicators



KNICK
ELEKTRONISCHE MESSGERÄTE
GMBH & CO. KG

Beuckestraße 22
14163 Berlin
Phone: +49 30 80191-0
www.knick-international.com