

Protos II 4400(X) / Protos 3400(X) Process Analysis System

User Manual

Protos CONDI 3400(X)-051 Measuring Module
For Conductivity Measurement with Toroidal Sensors

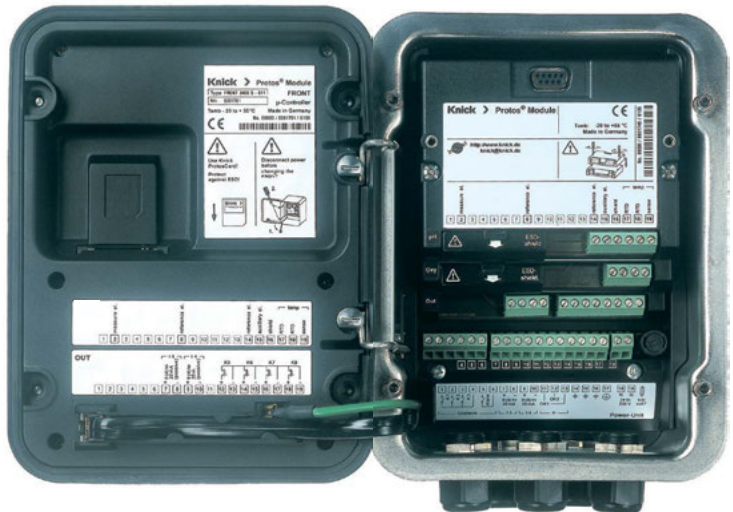

Returns

Clean and securely package the product before returning it to Knick Elektronische Messgeräte GmbH & Co. KG if required.

If there has been contact with hazardous substances, the product must be decontaminated or disinfected prior to shipment. The consignment must always be accompanied by a corresponding return form to prevent service employees being exposed to potential hazards.

Further information can be found at www.knick.de.

Disposal

The local codes and regulations must be observed when disposing of the product.

Table of Contents

Protos CONDI 3400(X)-051 Module

Returns	2
Disposal	2
Intended Use	5
Safety Instructions	6
Operation in Explosive Atmospheres: CONDI 3400X-051 Module	6
Firmware Version	7
Terminal Plate CONDI 3400-051 Module.....	8
Installing the Module.....	9
Preparing the Special Cable	10
Wiring Examples	11
Calibration / Adjustment	13
Temperature Compensation	15
HOLD Function During Calibration	16
Automatic with Standard Calibration Solution	18
Manual Entry of Calibration Solution	20
Product Calibration (Calibration by Sampling)	22
Data Entry of Premeasured Sensors	24
Zero Correction	25
Temp Probe Adjustment.....	26
Parameter Setting	27
Parameter Setting: Operating Levels	28
Parameter Setting: Locking a Function	29
Default Settings and Selection Range.....	31
TC Process Medium	32
Parameter Setting: Concentration Curves	33
Concentration Table	37
Configuring a Calculation Block	40
Logbook.....	41
Restore Factory Settings.....	41
Configuring the Current Output.....	44
Current Outputs: Characteristics	45
Current Outputs: Output Filter.....	47

Table of Contents

Protos CONDI 3400(X)-051 Module

Maintenance	48
Sensor Monitor.....	48
Temp Probe Adjustment.....	48
Diagnostic Functions	49
Opening the Diagnostics Menu.....	49
Point of Meas Description.....	49
Logbook.....	49
Device Description	50
FRONT Module.....	50
BASE Module.....	50
Module Diagnostics.....	51
Sensor Monitor.....	51
Calibration/Adjustment Record	51
Temp. Offset Log	51
Setting Diagnostic Messages as Favorite	52
Message list	54
Specifications.....	59
Appendix.....	63
Minimum Spans for Current Outputs	63
Overview	64
Overview of Parameter Setting.....	64
Index.....	68

Intended Use

The module is an input module for conductivity measurement with standard analog electrodeless (toroidal) sensors.

The CONDI 3400X-051 module is intended for operation in locations subject to explosion hazards which require equipment of Group II, device category 2(1), gas/dust.

Safety Instructions

Operation in Explosive Atmospheres: CONDI 3400X-051 Module

The module is approved for operation in explosive atmospheres.

When installing the product in a hazardous location, observe the information in the supplements to the certificates and, if applicable, the relevant control drawings.

Observe all applicable local and national codes and standards for the installation of electrical equipment in explosive atmospheres. For orientation, please refer to IEC 60079-14, EU directives 2014/34/EU and 1999/92/EC (ATEX), NFPA 70 (NEC), ANSI/ISA-RP12.06.01.

⚠ WARNING! Possible impairment of explosion protection.

- Modules which have already been used shall be subjected to a professional routine test before they may be operated in another type of protection.
- Prior to commissioning, the operating company must verify the intrinsic safety in accordance with the installation regulations of IEC 60079-14 for the complete interconnection of all equipment involved, including the connecting cables.
- The interconnection of Ex and non-Ex modules (mixed assembly) is not permitted.
- In hazardous locations the device shall only be cleaned with a damp cloth to prevent electrostatic charging.

Maintenance

The Protos modules cannot be repaired by the user. For inquiries regarding module repair, please contact Knick Elektronische Messgeräte GmbH & Co. KG at www.knick.de.

Firmware Version

CONDI 3400(X)-051 module firmware: Firmware version 2.x

Module compatibility	CONDI3400-051	CONDI3400X-051
Protos 3400 from FRONT firmware version 3.0	x	
Protos 3400X from FRONT firmware version 4.0		x
Protos II 4400 from FRONT firmware version 01.00.00	x	
Protos II 4400X from FRONT firmware version 01.00.00		x

Further information on the firmware version history can be found at www.knick.de.

Query Current Device Firmware/Module Firmware

When the device is in measuring mode:

Press **menu** key, open Diagnostics menu: Device Description

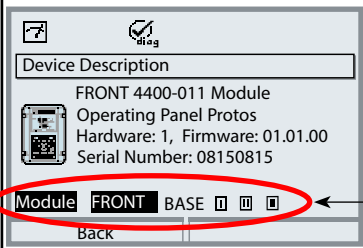
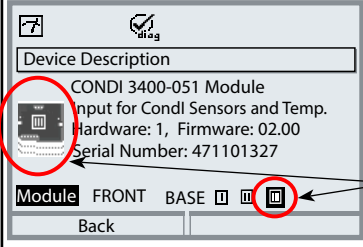
Menu	Display	Action
		<p>Device hardware and firmware version</p> <p>Provides information on all modules installed: Module type and function, serial number, hardware and firmware version, and device options.</p> <p>Select the different modules (FRONT, BASE, slots 1 - 3) using the arrow keys.</p>
		<p>Query module firmware</p> <p>Module CONDI 3400-051, hardware and firmware version, serial number – here installed in slot 3.</p>

Note: The display may vary depending on the device version.

Terminal Plate CONDI 3400-051 Module

Knick > Protos® Module

Type CONDI 3400-051
No.

CONDI
inductive
Conductivity / °C

Tamb: -20 to +55 °C
Made in Germany

CE

Internet www.knick.de

59802/0000000

00000

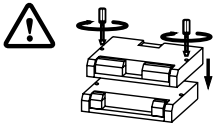

1	2	3	4	5	6	7	8	9	10	11	12	13	14	15	16	17	18	19
receive hi	receive lo	shield	send lo	send hi	shield	SensLoop									shield	RTD	RTD	sense
																temp		

Attaching the Terminal Plates

The terminal plates of the lower modules can be stuck to the inner side of the door. This facilitates maintenance and service.



Installing the Module

⚠ CAUTION! Electrostatic discharge (ESD).

The modules' signal inputs are sensitive to electrostatic discharge. Take measures to protect against ESD before inserting the module and wiring the inputs.

NOTICE! Strip the insulation from the wires using a suitable tool to prevent damage.



- 1) Switch off the power supply to the device.
- 2) Open the device (loosen the 4 screws on the front).
- 3) Plug the module into the slot (D-SUB connector), see figure.
- 4) Tighten the module's fastening screws.
- 5) Connect the sensor and separate temperature probe if necessary, see "Wiring Examples".
- 6) Check whether all connections are correctly wired.
- 7) Close the device by tightening the screws on the front.
- 8) Switch on the power supply.

⚠ CAUTION! Risk of losing the specified ingress protection.

Fasten the cable glands and screw together the housing correctly. Observe the permissible cable diameters and tightening torques (see the specifications of the basic unit). Insert blanking plugs or sealing inserts if necessary.

Connection of SE 655 / SE 656 Sensors

Preparing the Special Cable

Preparing the Shield Connection

Pre-assembled special cable for SE 655 / SE 656 sensors

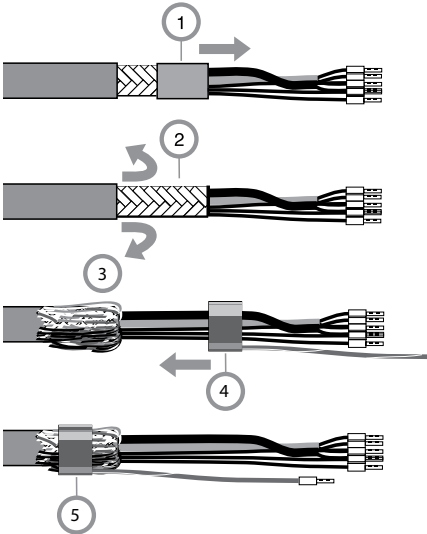

- Insert the special cable through the cable entry into the terminal compartment.
- Remove the already separated part of the cable insulation (1).
- Turn the shielding mesh (2) over the cable insulation (3).
- Then shift the crimp ring (4) over the shielding mesh and tighten it using a pincer (5)

Pre-Assembled Special Cable:

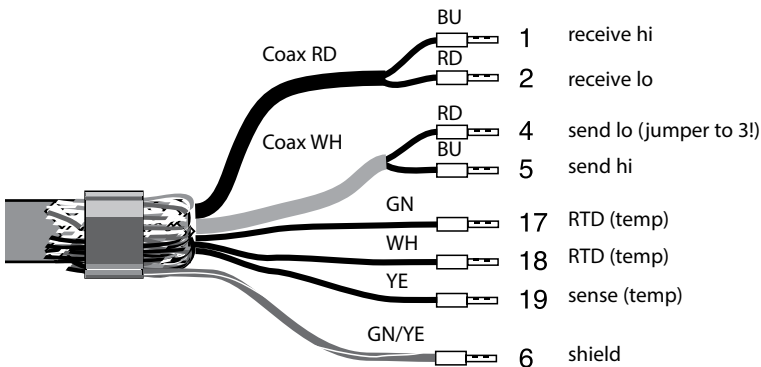

Wiring Examples

SE 655/SE 656 Sensor

Connecting the pre-assembled cable

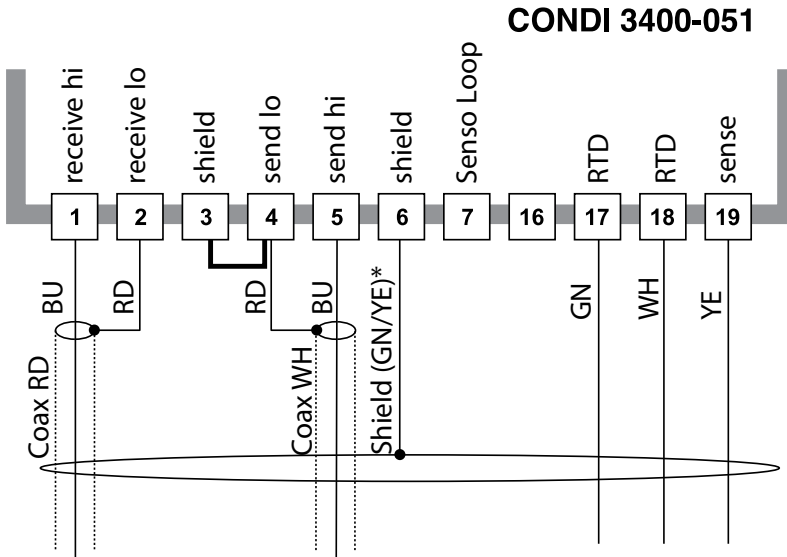

Note

- The shield wire (*, GN/YE) must be connected to the shielding mesh of the special cable using a crimp ring (see "Preparing the shield connection").
- Remove the pre-mounted jumper between terminals 18 and 19!

Wiring Examples

SE 660 Sensor

Connecting the pre-assembled cable

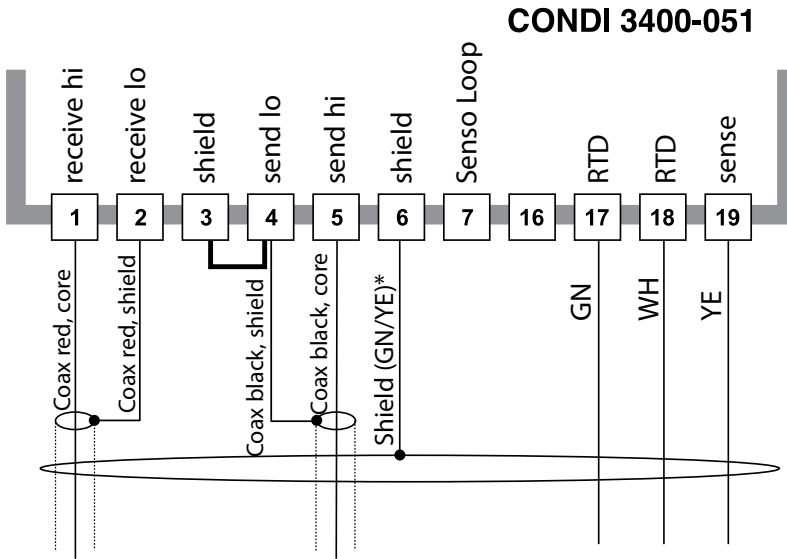

Note

- The brown wire is not connected.
- Remove the pre-mounted jumper between terminals 18 and 19!

Calibration / Adjustment

Note: Function check (HOLD) active for the currently calibrated module
Current outputs and relay contacts behave as configured

- **Calibration:** Detecting deviations without readjustment
- **Adjustment:** Detecting deviations with readjustment

NOTICE!

Without calibration every conductivity meter delivers an imprecise or wrong output value! Mechanical tolerances of the sensor as well as magnetic crosstalk between send and receive coils reduce the measurement accuracy.

To increase accuracy, it is useful to perform an adjustment.

Additional measurement errors occur when the sensor is installed in a restricted space (container wall < 4 x sensor diameter). This can be compensated for by product calibration, for example. When measuring low conductivity values, a zero correction is recommended.

Be sure to perform an adjustment after having replaced the sensor!

Procedure

Every conductivity sensor has its individual cell factor.

Depending on the sensor design, the cell factor may vary over a wide range. As the conductivity is calculated from the measured conductance and the cell factor, this must be known to the measuring system. For calibration or sensor standardization, either the known (stamped on) cell factor of the conductivity sensor used is entered in the measuring system or it is determined automatically by measuring a calibration solution with a known conductivity. The data are stored in a calibration record. By "Adjustment" the determined calibration data can be used for correction.

- Use fresh calibration solutions only!
- The calibration solution used must have been selected during parameter setting.
- Calibration accuracy decisively depends on the exact detection of the calibration solution's temperature. Using the measured or entered temperature, the measuring module determines the nominal value for the calibration solution from a stored table.
- Observe response time of temperature probe!
- For exact determination of the cell factor, wait until the temperature probe and calibration solution have the same temperature.

Calibration / Adjustment

Adjustment

means that the cell factor determined by a calibration is taken over. It is entered in the calibration record. (Cal record can be called up in the Diagnostics menu for the CONDI 3400(X)-051 module.)

The value is only effective for calculating the measured variables when the calibration has been terminated with an adjustment.

A passcode ensures that an adjustment can only be performed by an authorized person (Administrator). The Operator can check the current sensor data by a calibration and inform the Administrator when there are deviations. You can use the add-on function SW3400-107 ¹⁾ for granting access rights (passcodes) and for AuditTrail (continuous data recording and backup according to FDA 21 CFR Part 11).

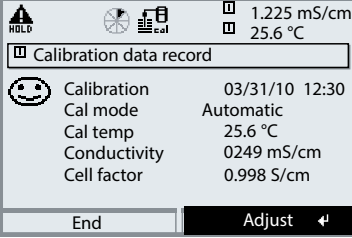
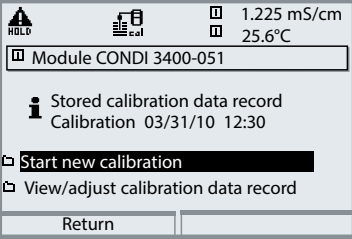
Menu	Display	Action
	 <p>1.225 mS/cm 25.6 °C</p> <p>Calibration data record</p> <p>Calibration 03/31/10 12:30 Cal mode Automatic Cal temp 25.6 °C Conductivity 0249 mS/cm Cell factor 0.998 S/cm</p> <p>End Adjust ←</p>	<p>Administrator</p> <p>With the corresponding access rights, the device can immediately be adjusted after calibration. The calibration values are taken over for calculating the measured variables.</p>
	 <p>1.225 mS/cm 25.6 °C</p> <p>Module CONDI 3400-051</p> <p>Stored calibration data record Calibration 03/31/10 12:30</p> <p>Start new calibration View/adjust calibration data record</p> <p>Return</p>	<p>Operator (without administrator rights)</p> <p>After calibration, change to measuring mode. Inform Administrator. When opening the menu (Calibration, respective module), the Administrator sees all data of the last calibration and can take over the values or perform a new calibration.</p>

Note: The display may vary depending on the device version.

Calibration / Adjustment

Temperature Compensation

Temperature Compensation During Calibration

The conductivity value of the calibration solution is temperature-dependent. For calibration, the calibration solution temperature must therefore be known in order to choose the actual value from the conductivity table.

During parameter setting you define whether cal temperature is measured automatically or must be entered manually.

Automatic Temperature Compensation

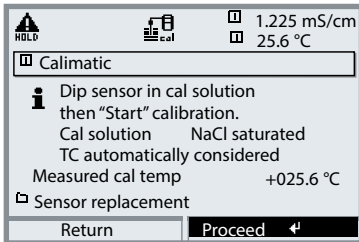

For automatic cal temp detection, the measuring module measures the temperature of the calibration solution with a temperature probe (Pt 100 / Pt 1000 / NTC 30 k Ω / NTC 100 k Ω).

If you work with automatic temperature compensation during calibration, a temperature probe connected to the temperature input of the Protos must be in the calibration solution.

When "Cal temp automatic" is set, "Measured cal temp" appears in the menu.

HOLD Function During Calibration

Behavior of the signal and relay outputs during calibration

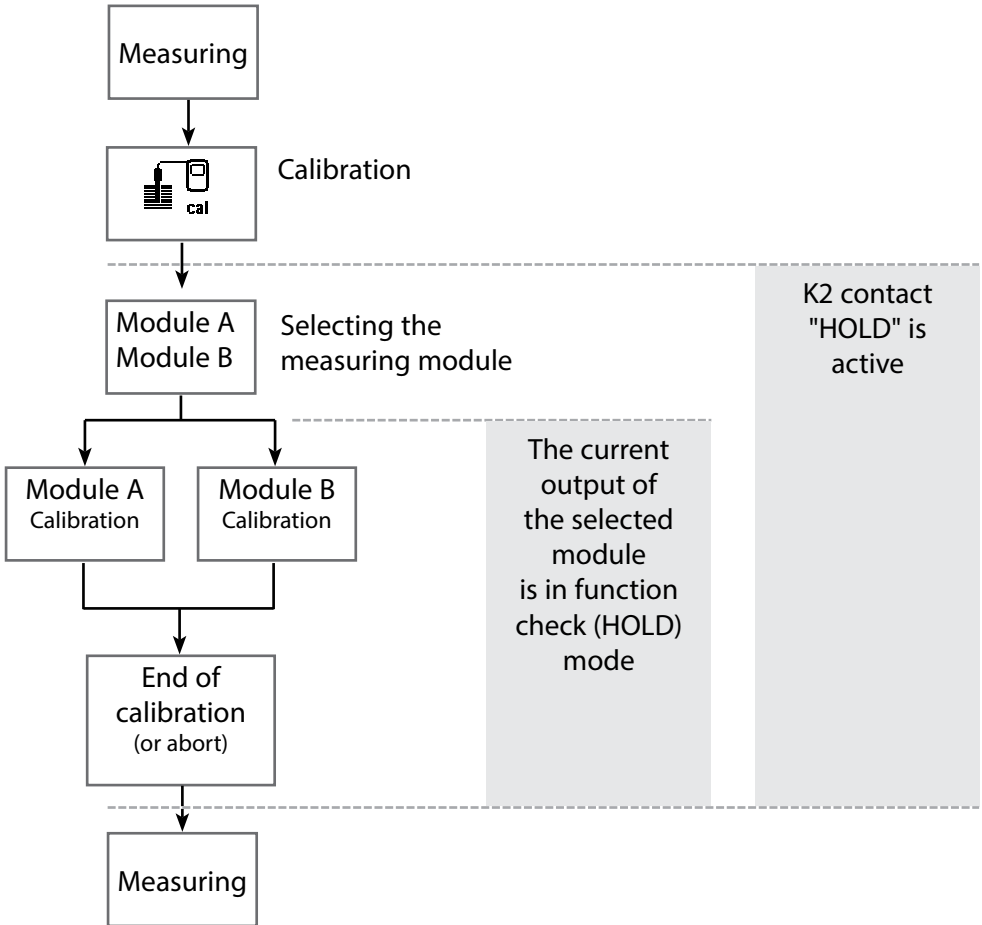

Note: The display may vary depending on the device version.

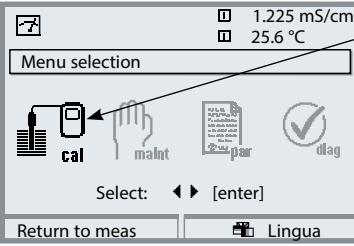
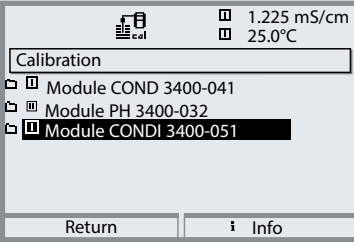
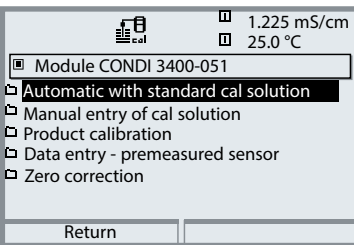
Menu	Display	Action
	  	<p>Open calibration Press menu key to select menu. Select calibration using arrow keys, confirm using enter, passcode 1147 (The passcode can be edited by the administrator.)</p> <p>Calibration: Select "Module CONDI"</p> <p>Select calibration method:</p> <ul style="list-style-type: none"> • Automatic with standard cal solution • Manual entry of cal solution • Product calibration • Data entry - premeasured sensor • Zero correction • Temp probe adjustment (with Protos II 4400(X)) <p>When you call up calibration, the analyzer automatically proposes the previous calibration method. If you do not want to calibrate, "Return" with the left softkey.</p> <p>During calibration the module is in function check (HOLD) mode. Current outputs and relay contacts of the module behave as configured (Module BASE).</p>

Calibration / Adjustment

Automatic Calibration with Standard Calibration Solution

Automatic with Standard Calibration Solution

For automatic calibration, the conductivity sensor is immersed in a standard calibration solution (NaCl or KCl, selected during parameter setting).

From the measured conductance and temperature, the Protos automatically calculates the cell factor.

The temperature dependence of the calibration solution is taken into account.

During calibration the module is in function check (HOLD) mode.

Current outputs and relay contacts of the module behave as configured (Module BASE).

NOTICE!

- Use fresh calibration solutions only!
- The calibration solution used must have been selected during parameter setting.
- Calibration accuracy decisively depends on the exact detection of the calibration solution's temperature. Using the measured or entered temperature, the Protos determines the nominal value for the calibration solution from a stored table.
- Observe response time of temperature probe!
- For exact determination of the cell factor, wait until the temperature probe and calibration solution have the same temperature.

Be sure to observe during calibration:

- If the measured conductance or the measured temperature fluctuate greatly, the calibration procedure is aborted after 2 min.
- If an error message appears, you have to repeat calibration.

Adjustment: Taking over the values determined by calibration

- When the values determined by calibration are correct, they must be taken over to adjust the analyzer.

Note: The display may vary depending on the device version.

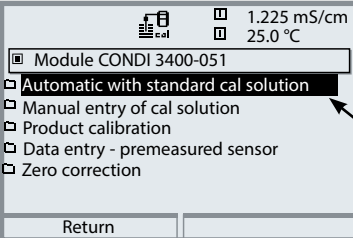
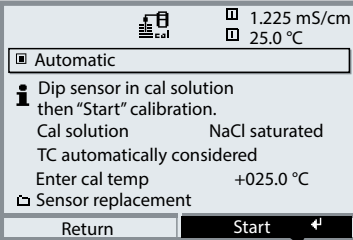
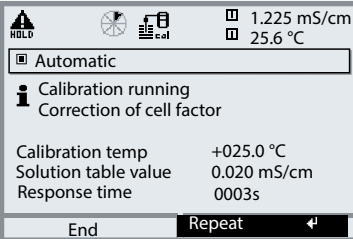
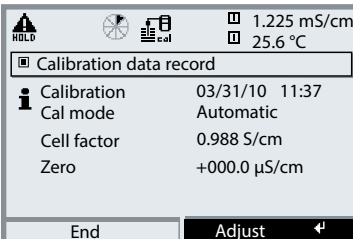
Menu	Display	Action
	 <p>1.225 mS/cm 25.0 °C</p> <p>Module CONDI 3400-051</p> <ul style="list-style-type: none"> Automatic with standard cal solution Manual entry of cal solution Product calibration Data entry - premeasured sensor Zero correction <p>Return</p>	<p>Select calibration menu Select "Module CONDI"</p> <p>Select calibration method "Automatic with standard cal solution", confirm with enter.</p>
	 <p>1.225 mS/cm 25.0 °C</p> <p>Automatic</p> <p>Dip sensor in cal solution then "Start" calibration. Cal solution NaCl saturated TC automatically considered Enter cal temp +025.0 °C Sensor replacement</p> <p>Return Start</p>	<p>Display of selected calibration solution.</p> <p>Enter process temperature, if manual temperature adjustment has been selected.</p> <p>Dip sensor in calibration solution. Start calibration with softkey or enter.</p>
	 <p>HOLD</p> <p>1.225 mS/cm 25.6 °C</p> <p>Automatic</p> <p>Calibration running Correction of cell factor</p> <p>Calibration temp +025.0 °C Solution table value 0.020 mS/cm Response time 0003s</p> <p>End Repeat</p>	<p>Calibration is running. The display shows:</p> <ul style="list-style-type: none"> • Calibration temperature • Solution table value (conductivity in dependence on process temperature) • Response time <p>Rinse sensor and replace it in the process, end calibration with softkey or enter</p>
	 <p>HOLD</p> <p>1.225 mS/cm 25.6 °C</p> <p>Calibration data record</p> <p>Calibration 03/31/10 11:37 Cal mode Automatic Cell factor 0.988 S/cm Zero +0000.0 µS/cm</p> <p>End Adjust</p>	<p>Adjustment</p> <p>Press "Adjust" to take over the values determined during calibration for calculating the measured variables.</p>

Calibration / Adjustment

Manual Entry of Calibration Solution

Manual Entry of Calibration Solution

For calibration with manual entry of the calibration solution's conductivity, the sensor is immersed in a calibration solution. Protos determines a conductivity/calibration temperature value pair. Then, the temperature-corrected conductivity value of the solution must be entered. To do this, read off the conductivity for the temperature displayed from the TC table of the calibration solution. Intermediate temperature values must be interpolated. Protos automatically calculates the cell factor.

During calibration the module is in function check (HOLD) mode.

Current outputs and relay contacts of the module behave as configured (Module BASE).

NOTICE!

- Use fresh calibration solutions only!
- The calibration solution used must have been selected during parameter setting.
- Calibration accuracy decisively depends on the exact detection of the calibration solution's temperature. Using the measured or entered temperature, the Protos determines the nominal value for the calibration solution from a stored table.
- Observe response time of temperature probe!
- For exact determination of the cell factor, wait until the temperature probe and calibration solution have the same temperature.

Be sure to observe during calibration:

- If the measured conductance or the measured temperature fluctuate greatly, the calibration procedure is aborted after 2 min.
- If an error message appears, you have to repeat calibration.

Adjustment: Taking over the values determined by calibration

- When the values determined by calibration are correct, they must be taken over to adjust the analyzer.

Note: The display may vary depending on the device version.

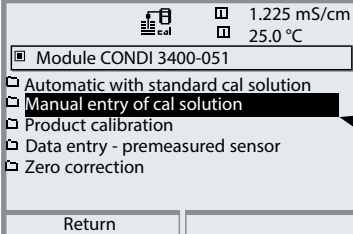
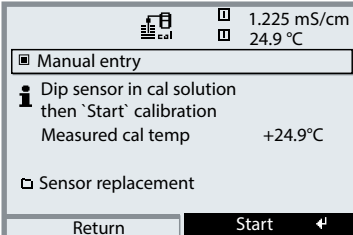
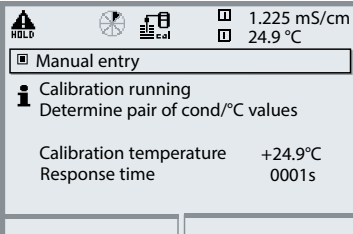
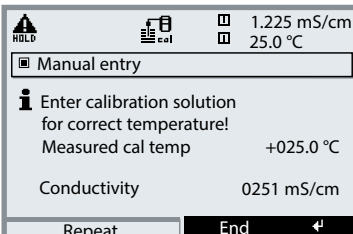
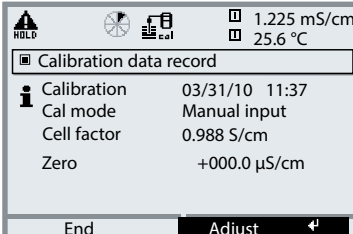
Menu	Display	Action
	 <p>Module CONDI 3400-051</p> <ul style="list-style-type: none"> Automatic with standard cal solution Manual entry of cal solution Product calibration Data entry - premeasured sensor Zero correction <p>Return</p>	<p>Select calibration menu Select "Module CONDI"</p> <p>Select calibration method "Manual entry of cal solution", confirm with enter.</p>
	 <p>Manual entry</p> <p>Dip sensor in cal solution then `Start` calibration Measured cal temp +24.9°C</p> <p>Sensor replacement</p> <p>Return Start</p>	<p>Enter process temperature, if manual temperature adjustment has been selected. Immerse sensor in cal solution. Start calibration with softkey or enter.</p>
	 <p>Manual entry</p> <p>Calibration running Determine pair of cond/°C values</p> <p>Calibration temperature +24.9°C Response time 0001s</p>	<p>Calibration is running. The display shows:</p> <ul style="list-style-type: none"> • Calibration temperature • Response time
	 <p>Manual entry</p> <p>Enter calibration solution for correct temperature! Measured cal temp +025.0 °C</p> <p>Conductivity 0251 mS/cm</p> <p>Repeat End</p>	<p>Enter conductivity. End calibration using softkey ("End").</p>
	 <p>Calibration data record</p> <p>Cal mode 03/31/10 11:37 Manual input Cell factor 0.988 S/cm Zero +000.0 µS/cm</p> <p>End Adjust</p>	<p>Adjustment Press "Adjust" to take over the values determined during calibration for calculating the measured variables.</p>

Calibration / Adjustment

Product Calibration

Product Calibration (Calibration by Sampling)

When the sensor cannot be removed, e.g. for sterility reasons (for biotechnical processes), its cell constant can be determined with “sampling”.

To do so, the currently measured process value (conductivity or concentration¹⁾) is saved by the Protos.

Immediately afterwards, you take a sample from the process. The sample value should be measured at process conditions (same temperature!). The determined value is entered in the measuring system. From the difference between process value and sample value, the Protos calculates the cell constant of the conductivity sensor.

During calibration the module is in function check (HOLD) mode.

Current outputs and relay contacts of the module behave as configured (Module BASE).

Product calibration without TC correction (for conductivity)

Take a sample from the process. Measure its value at the temperature at which the sample has been taken (“Sample temp”, see display). To do so, it may be necessary to thermostat the sample correspondingly in the lab.

Temperature compensation must be turned off at the comparison meters (TC = 0 %/K).

Product calibration with TC correction Tref = 25 °C/77 °F (for conductivity)

Take a sample from the process. When measuring in the lab (TC linear), be sure that the same values are set for reference temperature and temperature coefficient in the comparison meter and in the Protos. Furthermore, the measuring temperature should correspond to the sample temperature (see display).

Transport the sample in an insulated container (Dewar).

NOTICE!

Product calibration can only be performed if the process medium is stable. That means, for example, that there are no chemical reactions which have an effect on the process conductivity. At higher temperatures, the sample values can also be invalidated due to evaporation.

Note: The display may vary depending on the device version.

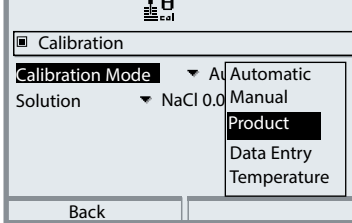
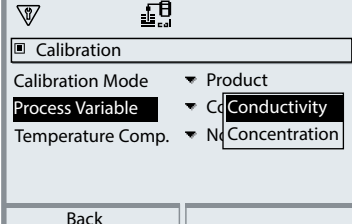
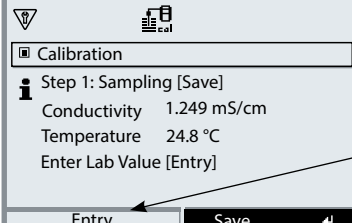
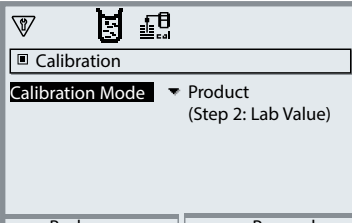
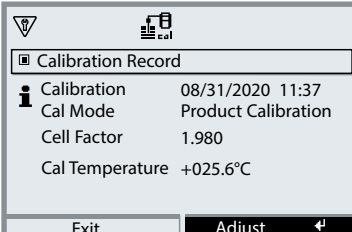
Menu	Display	Action
	 <p>Calibration</p> <p>Calibration Mode ▾ Automatic Manual</p> <p>Solution ▾ NaCl 0.0</p> <p>Product</p> <p>Data Entry Temperature</p> <p>Back</p>	<p>Select calibration. Select COND module. Select Calibration Mode > Product and press enter to confirm. Select Process Variable > Conductivity or Concentration¹⁾. Conductivity: calibration with/without temperature compensation Concentration: Select the medium.</p>
	 <p>Calibration</p> <p>Calibration Mode ▾ Product</p> <p>Process Variable ▾ Cd Conductivity</p> <p>Temperature Comp. ▾ Ni Concentration</p> <p>Back</p>	<p>Step 1 Take sample. Store measured value and temperature at the moment of sampling ("Save" softkey or enter). The analyzer automatically returns to calibration mode selection. Press meas to return to measurement.</p>
	 <p>Calibration</p> <p>Step 1: Sampling [Save]</p> <p>Conductivity 1.249 mS/cm</p> <p>Temperature 24.8 °C</p> <p>Enter Lab Value [Entry]</p> <p>Entry Save</p>	<p>Press meas to return to measurement. Exception: Sample value can be determined and entered on site: Left softkey: "Entry"</p>
	 <p>Calibration</p> <p>Calibration Mode ▾ Product (Step 2: Lab Value)</p> <p>Back Proceed</p>	<p>Step 2 Lab value has been measured. Open the calibration menu again. Right softkey: "Entry" Enter reference value ("Lab value"). Confirm with "OK" or repeat calibration.</p>
	 <p>Calibration Record</p> <p>Calibration 08/31/2020 11:37</p> <p>Cal Mode Product Calibration</p> <p>Cell Factor 1.980</p> <p>Cal Temperature +025.6°C</p> <p>Exit Adjust</p>	<p>Adjustment Press "Adjust" softkey to take over the values determined during calibration for calculating the measured variables.</p>

1) with Protos II 4400(X) and add-on function FW4400-009

Calibration / Adjustment

Data Entry of Premeasured Sensors

Data Entry of Premeasured Sensors

Entry of cell factor and zero point of a sensor, related to 25 °C/77 °F, 1013 mbar.

During calibration the module is in function check (HOLD) mode.

Current outputs and relay contacts of the module behave as configured (Module BASE).

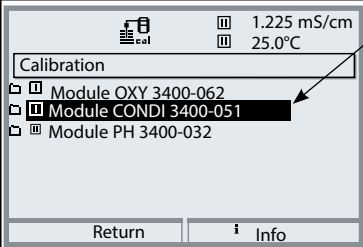
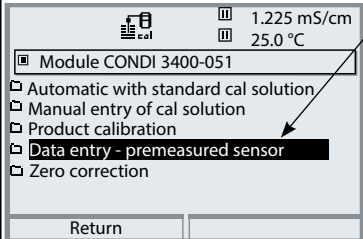
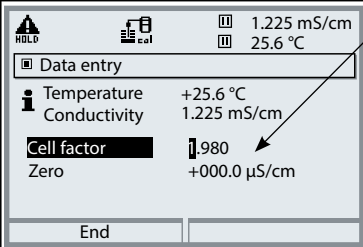
Menu	Display	Action
		<p>Select module: CONDI</p> <p>During calibration, the output currents (1 and 2), limit contacts, and controller output are in HOLD mode.</p> <p>Confirm with enter</p>
		<p>Select calibration method "Data entry"</p> <p>Confirm with enter</p>
		<p>Enter the cell factor of a premeasured sensor. Confirm with "OK" or repeat calibration.</p> <p>With "Concentration" enabled, a concentration calibration can be performed by changing the cell factor value – NOTICE! The cell factor value is immediately changed in the memory, even if calibration is aborted by pressing meas.</p>

Note: The display may vary depending on the device version.

Calibration / Adjustment

Zero Correction

Zero Correction

Adjustment of zero point / Automatic determination of the zero point in air
 Every electrodeless (toroidal) conductivity sensor has its individual zero point.
 When measuring low conductivity values, accuracy can be increased by adjusting the zero point.

During calibration the module is in function check (HOLD) mode.

Current outputs and relay contacts of the module behave as configured (Module BASE).

Note: The display may vary depending on the device version.

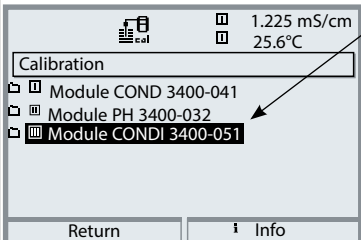
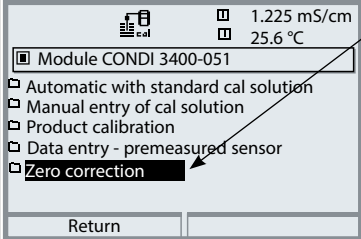
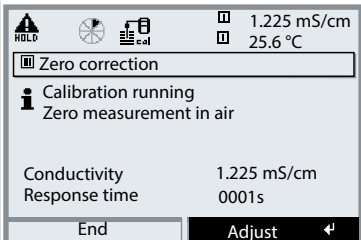
Menu	Display	Action
	 <p>1.225 mS/cm 25.6°C</p> <p>Calibration</p> <ul style="list-style-type: none"> Module COND 3400-041 Module PH 3400-032 Module CONDI 3400-051 <p>Return Info</p>	<p>Select module: CONDI Confirm with enter</p>
	 <p>1.225 mS/cm 25.6°C</p> <p>Module CONDI 3400-051</p> <ul style="list-style-type: none"> Automatic with standard cal solution Manual entry of cal solution Product calibration Data entry - premeasured sensor Zero correction <p>Return</p>	<p>Select calibration method "Zero correction" Remove the sensor from the process and dry it. Confirm with enter</p>
	 <p>1.225 mS/cm 25.6°C</p> <p>Zero correction</p> <p>Calibration running Zero measurement in air</p> <p>Conductivity 1.225 mS/cm Response time 0001s</p> <p>End Adjust</p>	<p>Permissible zero point deviation depends on the sensor type. For the SE 655 (SE656), it is ± 0.050 mS/cm. Press Adjust to take over the calibration data.</p>

Calibration / Adjustment

Temp Probe Adjustment

Note: With Protos II 4400(X) in the Calibration menu,
with Protos 3400(X) in the Maintenance menu.

Temp Probe Adjustment

This function allows compensating for the individual temperature probe tolerance and the influence of the lead resistances to increase the accuracy of temperature measurement. Make sure that the process temperature is precisely measured using a calibrated reference thermometer when performing an adjustment. The measurement error of the reference thermometer should be less than 0.1 °C. Adjustment without precise measurement might result in considerable deviations of the measured value display!

With Protos II 4400(X), the data from the last adjustment and the temperature offset can be called from the Diagnostics menu, see p. 51.

Parameter Setting

⚠ CAUTION!

Incorrect parameter setting, calibration or adjustment may result in incorrect measurements being recorded. Protos must therefore be commissioned by a system specialist, all its parameters must be set, and it must be fully adjusted.

NOTICE!

The "function check" (HOLD) mode is active during parameter setting. The behavior of the current outputs depends on the parameter setting, i.e., they may be frozen at the last measurement or set to a fixed value. The red "Alarm" LED blinks.

Measurement operations must not be carried out while the Protos is in the function check (HOLD) mode, as this may put the user at risk due to unexpected system behavior.

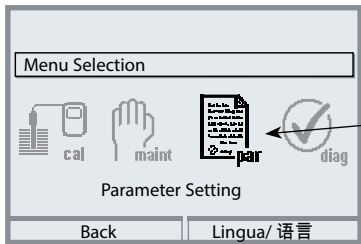
Menu	Display	Action
		Open the Parameter Setting menu From the measuring mode: Press menu key to select menu. Select parameter setting using arrow keys, press enter to confirm

Parameter Setting: Operating Levels

Viewing level, Operator level, Administrator level

Note: Function check (HOLD) mode active (Setting: BASE module)

Note: The display may vary depending on the device version.

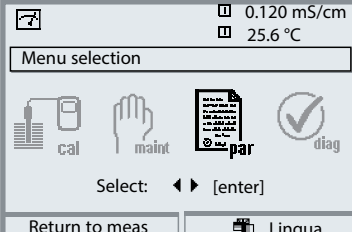
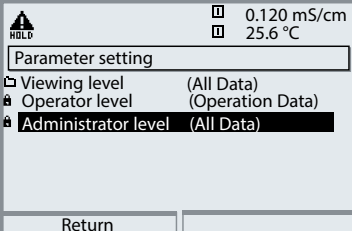
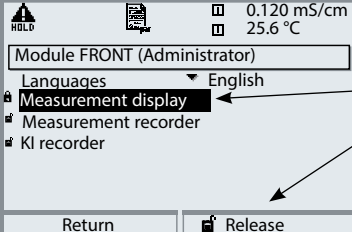
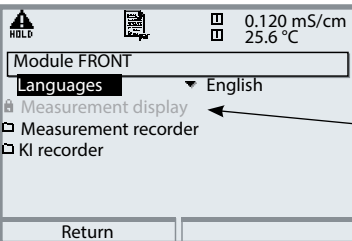

Menu	Display	Action
		<p>Open parameter setting From the measuring mode: Press menu key to select menu. Select parameter setting using arrow keys, press enter to confirm.</p>
		<p>Administrator level Access to all functions, also passcode setting. Releasing or blocking a function for access from the Operator level.</p>
		<p>Functions which can be blocked for the Operator level are marked with the "lock" symbol. The functions are released or blocked using the softkey.</p>
		<p>Operator level Access to all functions which have been released at the Administrator level. Blocked functions are displayed in gray and cannot be edited (Fig.).</p> <p>Viewing level Display of all settings. No editing possible!</p>

Parameter Setting: Locking a Function

Administrator level: Enabling/locking functions for Operator level

Note: Function check (HOLD) mode active (Setting: BASE module)

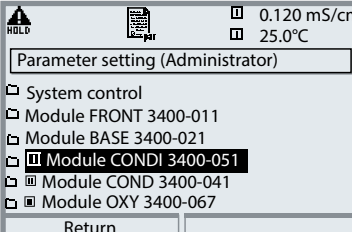
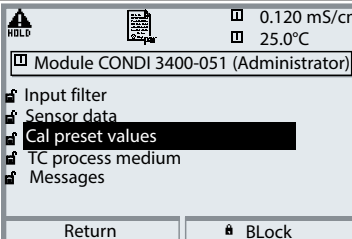
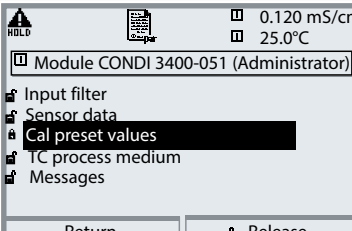
Note: The display may vary depending on the device version.

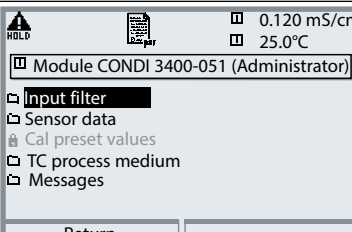
Menu	Display	Action
		<p>Example: Blocking access to the calibration adjustments from the Operator level</p> <p>Open parameter setting Select Administrator level. Enter passcode (1989). Select "Module COND" (e.g.) using arrow keys, press enter to confirm.</p>
		<p>Select "Cal preset values" using arrow keys. "Block" with softkey.</p>
		<p>Now, the "Cal preset values" line is marked with the "lock" icon. This function cannot be accessed from the Operator level any more. The softkey function changes to "Release".</p>
		<p>Open parameter setting Select <u>Operator level</u>, passcode (1246). Select "Module COND". Now, the locked function is displayed in gray and marked with the "lock" icon.</p>

Parameter Setting

Note: The display may vary depending on the device version.

Menu	Display	Action
		<p>Activating parameter setting</p> <p>From the measuring mode: Press menu key to select menu. Select parameter setting using arrow keys, press enter to confirm. Passcode as delivered: 1989</p>
		<p>Select module, press enter to confirm.</p> <p>(In the Figure, the "Module COND" is selected, for example.)</p>
		<p>Select parameter using arrow keys, press enter to confirm.</p>

During parameter setting the analyzer is in function check (HOLD) mode:
 Current outputs and relay contacts behave as configured (BASE module).

Parameter Setting

Default Settings and Selection Range

Note: Function check (HOLD) mode active.

Note: The menus may vary depending on the device version.

Parameter	Default	Selection / Range
Input filter <ul style="list-style-type: none"> Pulse suppression 	Off	Off, On (suppression of input interferences)
Sensor data <ul style="list-style-type: none"> Sensor type Sensor coding Nom. cell factor Transfer ratio Temperature detection <ul style="list-style-type: none"> Measuring temp Cal temp Sensocheck 	SE 655 F0031 01.980 120.00 Pt 100 Auto Auto Off	SE 652 SE 654 SE 655, SE 656 F0031 60120 F0031 01.880 02.150 01.980 125.10 048.30 120.00 Pt100, Pt1000, Pt100, NTC30kohm (sensor selection) Auto, manual: Default +25.0 °C (entry) Auto, manual: Default +25.0 °C (entry) Off, Failure, Maint. request
Protos II 4400(X): Cal Presettings Calibration Mode <p>Automatic:</p> <ul style="list-style-type: none"> Cal. Solution <p>Product:</p> <ul style="list-style-type: none"> Conductivity Concentration ¹⁾ 	Automatic NaCl saturated Conductivity Without TC NaCl (0...26 %)	Automatic, Manual, Product, Data Entry, Temperature Automatic: Cal solution NaCl 0.01 mol/l, NaCl 0.1 mol/l, NaCl saturated, KCl 0.01 mol/l KCl 0.1 mol/l, KCl 1 mol/l Conductivity, Concentration ¹⁾ With/Without TC Medium, see p. 33
Protos 3400(X): Cal preset values Calibration solution Product calibration	NaCl saturated Without TC	NaCl ..., KCl ..., see above Without TC, with TC
TC process medium <ul style="list-style-type: none"> TC correction Reference temp 	Off 25 °C	Off, linear, EN 27888, ultrapure water (Linear: enter TC and reference temp)

1) with add-on function FW4400-009

2) with add-on function SW3400-008/FW4400-008

Parameter Setting

TC Process Medium

Note: HOLD mode active

Note: The display may vary depending on the device version.

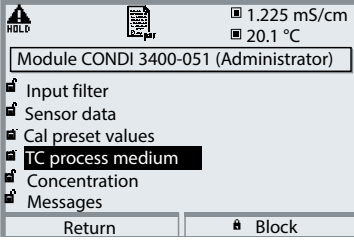
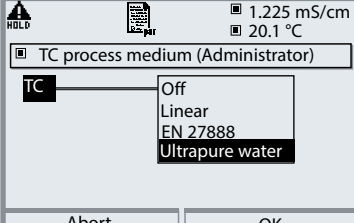
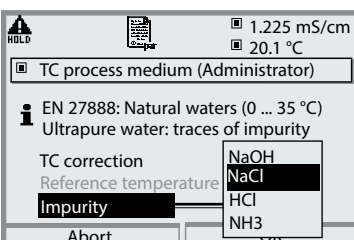
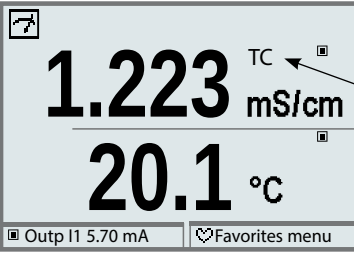
Menu	Display	Action
		<p>TC process medium</p> <p>You can choose from:</p> <ul style="list-style-type: none"> • Linear (input of TC coefficient) • EN 27888 • Ultrapure water (add-on function SW3400-008 / FW4400-008)
		<p>When you have selected "Ultrapure water", you must specify the type of impurity:</p> <p>NaOH Alkaline ultrapure water</p> <p>NaCl Neutral ultrapure water, for conductivity measurement in water processing behind gravel bed filter</p>
		<p>HCl Acidic ultrapure water, for conductivity measurement behind cation filter</p> <p>NH₃ Ammoniacal ultrapure water</p>
		<p>When the TC correction for process medium is switched on, "TC" appears in the display in measuring mode.</p>

Parameter Setting: Concentration Curves

Default Settings and Selection Range (SW 3400-009 / FW4400-009)

Note: Function check (HOLD) mode active.

Note: The menus may vary depending on the device version.

Parameter	Default	Selection / Range
Concentration (with add-on function SW3400-009/FW4400-009 only • Medium ("Yes" selected)	Off H_2SO_4 (0-30%)	On, Off NaCl (0-28 %), HCl (0-18 %), NaOH (0-24 %), H_2SO_4 (0-37 %), HNO_3 (0-30 %), H_2SO_4 (89-99 %), HCl (22-39 %), HNO_3 (35-96 %), H_2SO_4 (28-88 %), NaOH (15-50 %), Oleum (12-45%) Table

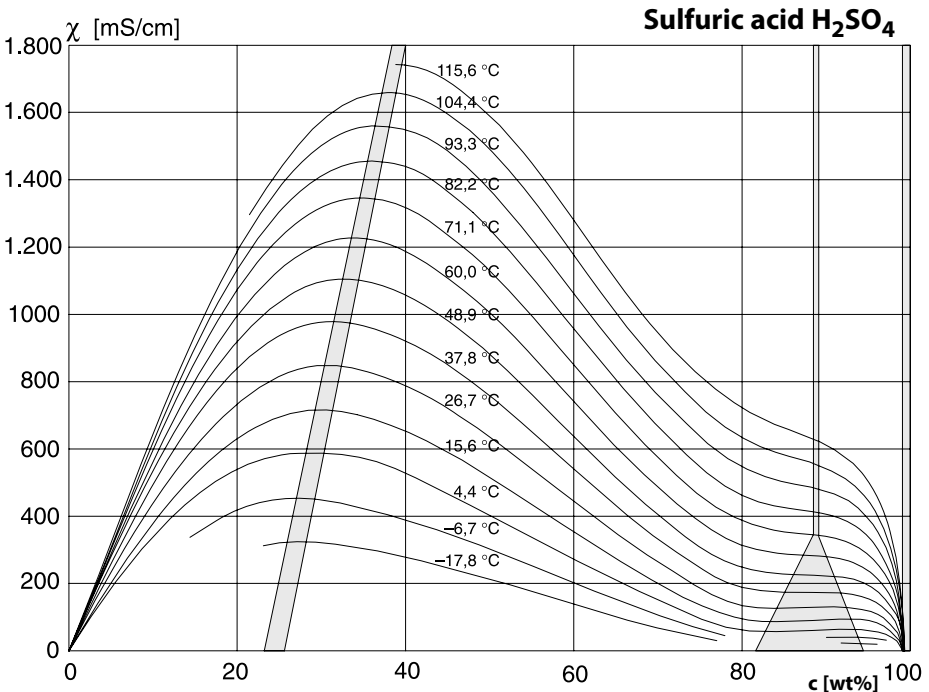

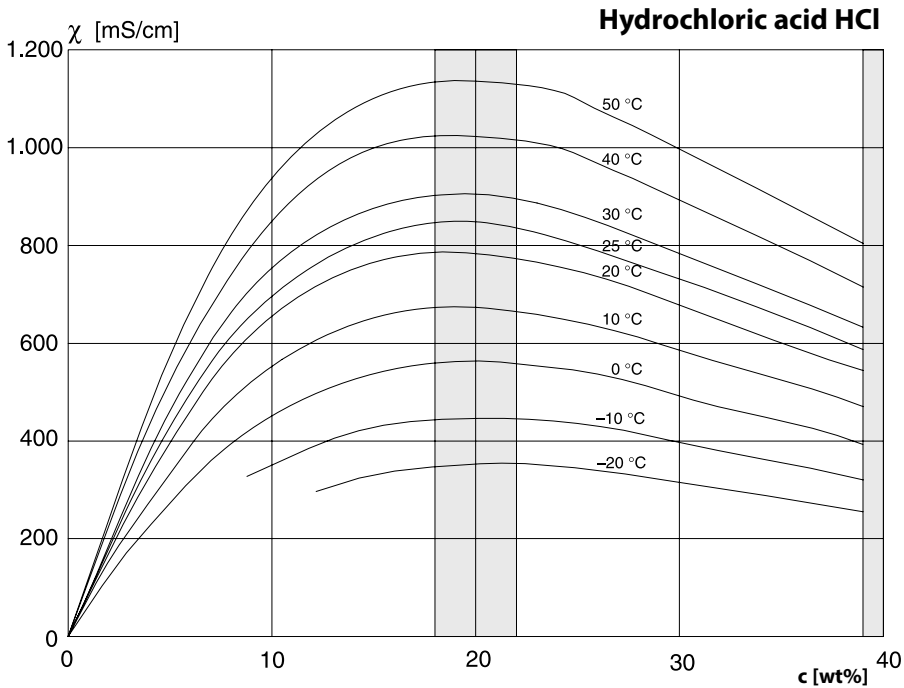
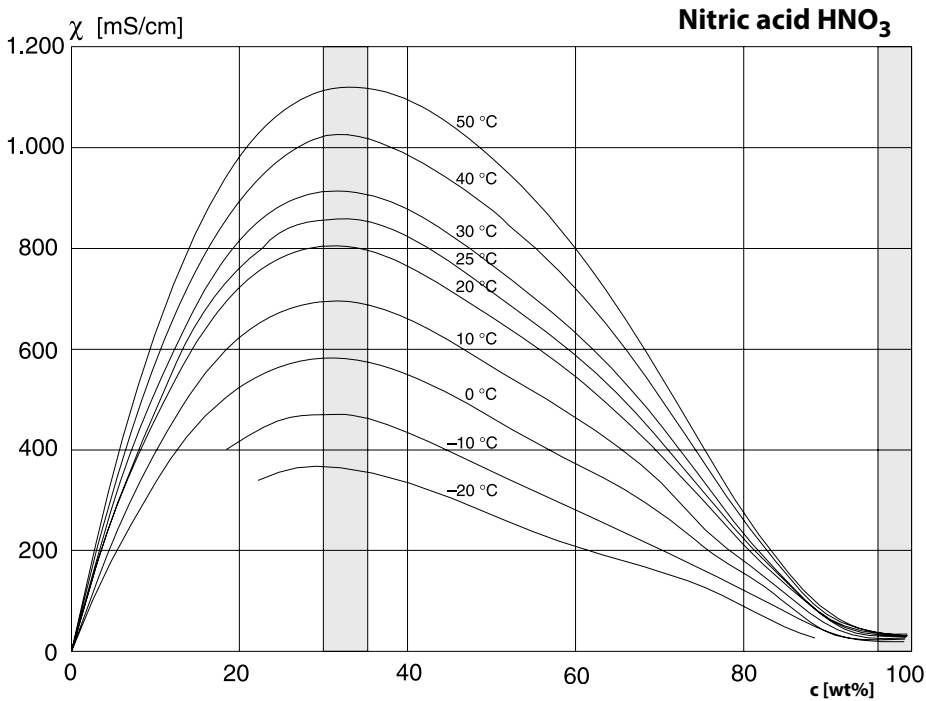

Sodium hydroxide solution NaOH

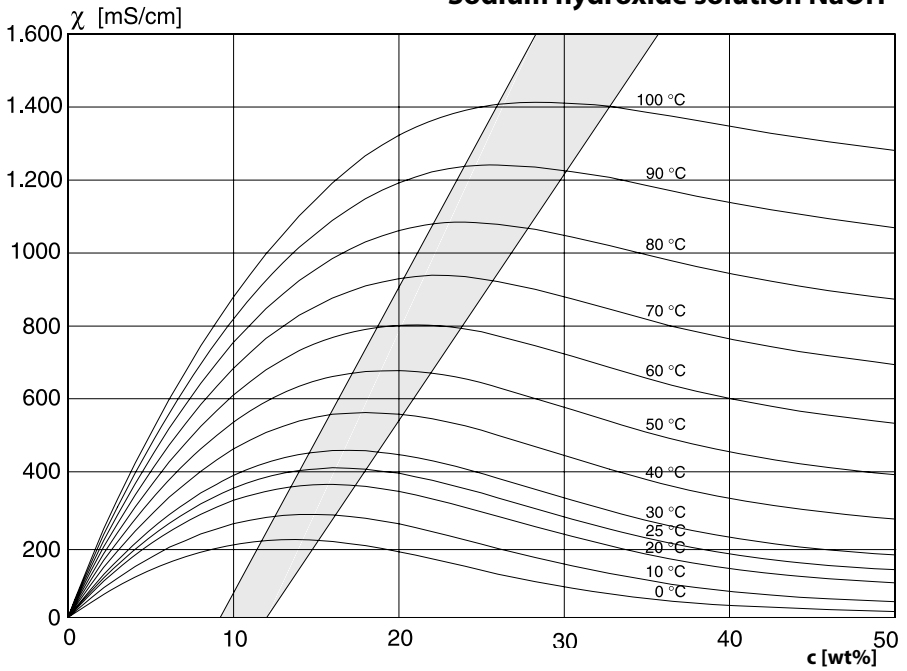
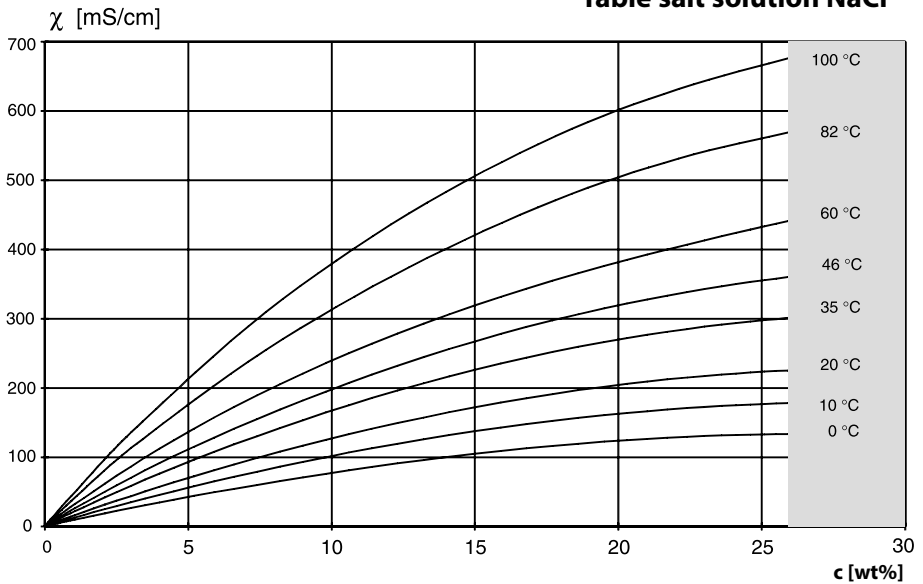
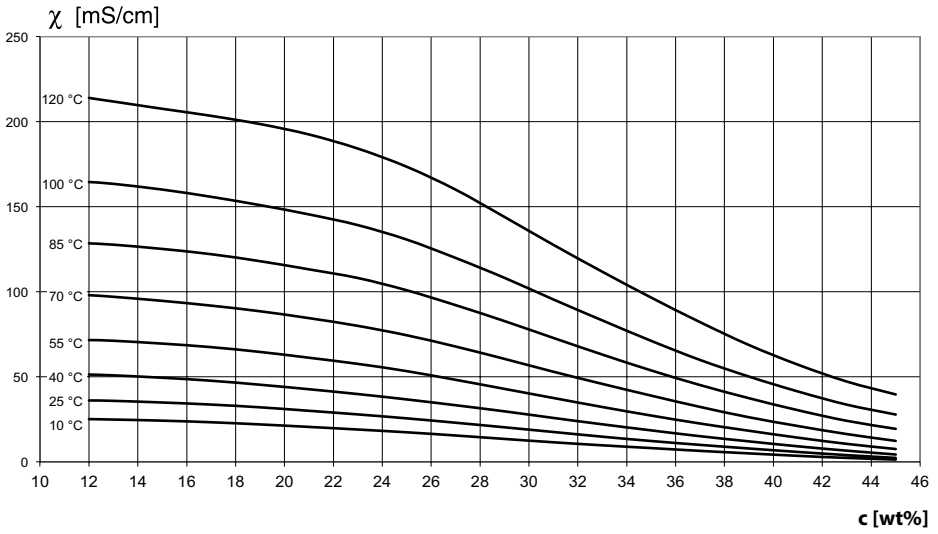

Table salt solution NaCl



Oleum $\text{H}_2\text{SO}_4 \cdot \text{SO}_3$



Concentration Table

Select menu: Parameter setting > System control > Concentration table

Specifying a concentration solution for conductivity measurement

To specify the customer-specific solution, 5 concentration values A-E are entered in a matrix together with 5 temperature values 1-5. To do so, first enter the 5 temperature values, then enter the respective conductivity values for each concentration A-E.

These solutions will then be available in addition to the permanently stored standard solutions (select "Table").

Note: The display may vary depending on the device version.

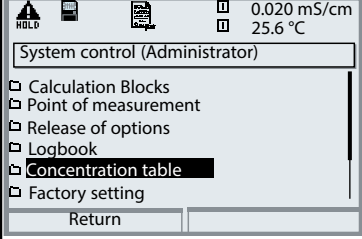
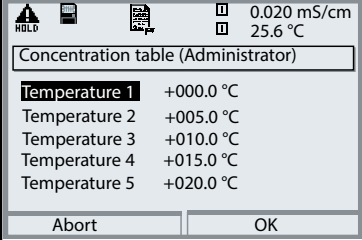
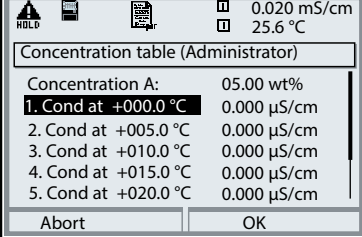
Menu	Display	Action
		To enter values <ul style="list-style-type: none"> • Open parameter setting • System control • Select "Concentration table"
		Enter 5 temperature values (right/left arrow keys to select position, up/down arrow keys to edit number, confirm by pressing enter .)
		Enter values for concentrations A-E for the respective temperatures. The table values must be continuous. Maxima/minima are not permitted. Incorrect entries are marked with ✕.

The concentration table is selected as follows:

Parameter setting > Module CONDI > Cal presettings:

Calibration mode: Automatic, Cal solution: Table.

Calculation Blocks

Select menu: Parameter setting > System control > Calculation Blocks
Calculation of new variables from measured variables

Calculation Blocks

Two measuring modules with all their measured values serve as input for the calculation block. In addition, the general device status (NAMUR signals) is taken into account. The difference between the existing values is calculated:

Current Outputs

All current outputs can be set to output the new process variables formed by the Calculation Blocks.

Measurement Display

All new process variables can be displayed as primary or as secondary value.

Controller

Controller functions are not supported.

Functionality of Measuring Module

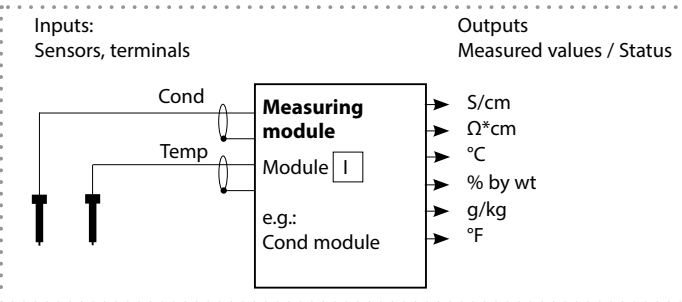

Functionality of Calculation Block

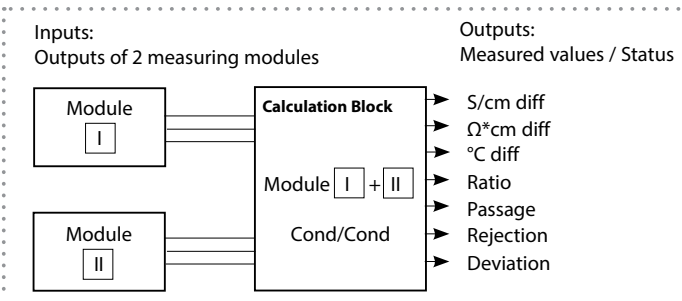

Activating a Calculation Block

Select menu: Parameter setting > System control > Calculation Blocks

Combination of 2 Measuring Modules

With three measuring modules the following Calculation Block combinations are possible:  +  ,  +  ,  + 

Two Calculation Blocks can be activated.

Note: The display may vary depending on the device version.

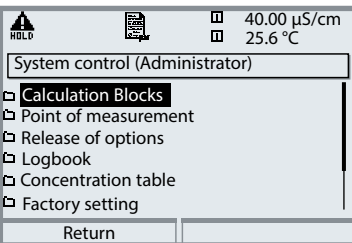
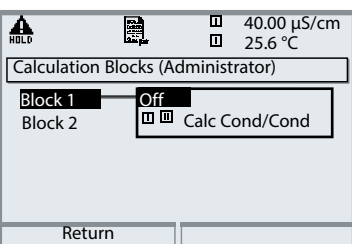
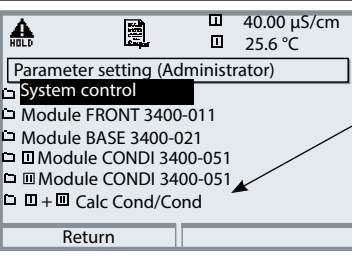
Menu	Display	Action
		<p>Calculation Blocks</p> <ul style="list-style-type: none"> • Open parameter setting • System control • Select “Calculation Blocks”
		<ul style="list-style-type: none"> • Depending on the modules installed, the possible combinations for Calculation Blocks are offered.
		<p>During parameter setting the Calculation Blocks are displayed like modules.</p>

Configuring a Calculation Block

Select menu: Parameter setting > System control > Calculation Blocks

Setting the process variable to be calculated

Note: The display may vary depending on the device version.

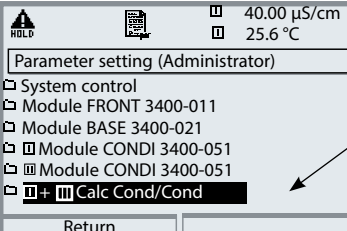
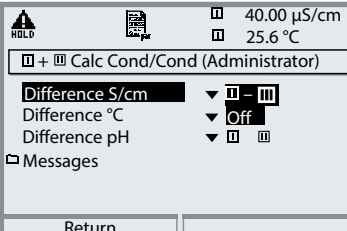
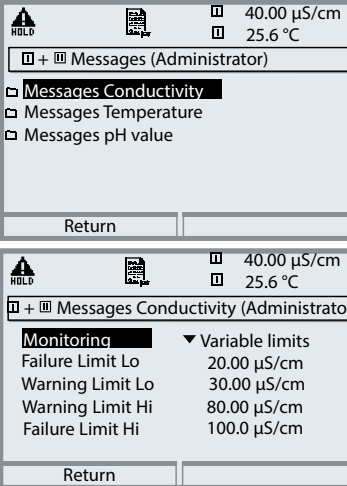
Menu	Display	Action
		<p>Select Calculation Block</p> <ul style="list-style-type: none"> • Open parameter setting • System control • Select module
		<p>Depending on the modules installed, the possible combinations for Calculation Blocks are offered.</p>
		<p>Messages</p> <p>You can activate messages for the selected variables.</p> <p>Variables which have been set as “Off” cannot be processed further.</p> <p>The measured values which shall release a message are set using the arrow keys (left/right: select position, up/down: edit number). Confirm by pressing enter.</p>

Parameter Setting

Parameter setting > System control

Note: Function check (HOLD) mode active

Note: The display may vary depending on the device version.

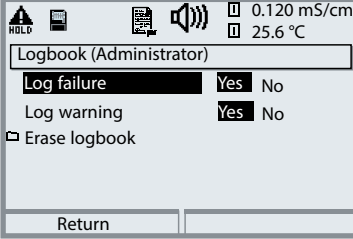
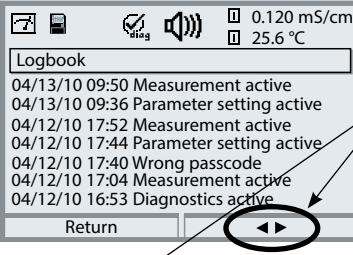
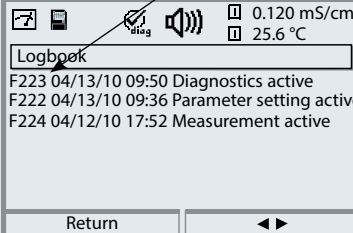
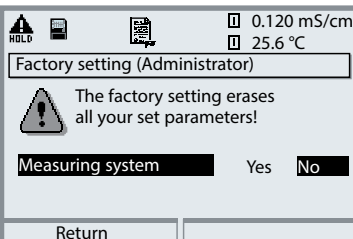
Menu	Display	Action
		<p>Logbook</p> <p>Select which messages are to be recorded in the logbook.</p> <p>The logbook directly displays the last events with date and time, e.g. calibrations, warning and failure messages, power failure (Protos 3400(X): 50, Protos II 4400(X): 100 events).</p>
		<p>The logbook entries can be called from the Diagnostics menu (Fig.). Pressing the right softkey displays the message identifier.</p>
		<p>SW3400-104: Extended logbook / FW4400-104: Logbook</p> <p>With SmartMedia Card and Protos 3400(X) or Data Card and Protos II 4400(X), max. 50,000 entries (Protos 3400(X)) or min. 20,000 entries (Protos II 4400(X)) can be saved on a memory card.</p>
		<p>Restore Factory Settings</p> <p>Allows resetting the parameters to their factory setting.</p>

Parameter Setting

Parameter Setting > CONDI Module > Messages: Default settings and selection range

Note: Function check (HOLD) mode active

Note: The menus may vary depending on the device version

Parameter	Default	Selection / Range
Messages <ul style="list-style-type: none"> • Conductivity • Resistivity • Concentration • Temperature • Salinity 	Limits max Off Off Off Off	Off, device limits max., variable limits* Off, device limits max., variable limits* Off, device limits max., variable limits* Off, device limits max., variable limits* Off, device limits max., variable limits*
		* With "Variable limits" selected, the following parameters can be edited: <ul style="list-style-type: none"> • Failure Limit Lo • Warning Limit Lo • Warning Limit Hi • Failure Limit Hi

Device limits

- Max. device limits: Maximum measuring range of device
- Variable limits: Range limits specified

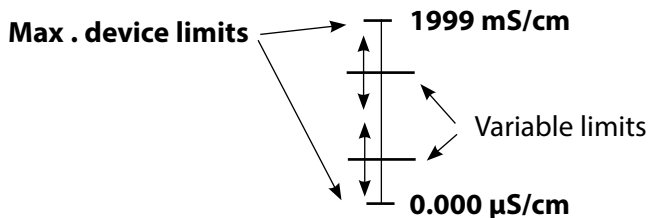





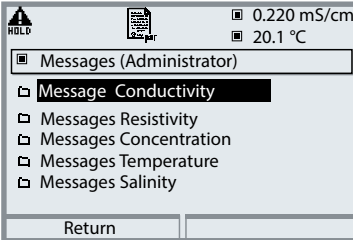

Parameter Setting

Parameter Setting > COND Module > Messages

Note: Function check (HOLD) mode active

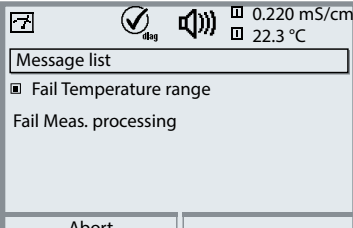
Note: The display may vary depending on the device version.

Menu	Display	Action
	 <p>Messages (Administrator)</p> <ul style="list-style-type: none"> Message Conductivity Messages Resistivity Messages Concentration Messages Temperature Messages Salinity <p>Return</p>	<h3>Messages</h3> <p>All parameters determined by the measuring module can generate messages.</p> <ul style="list-style-type: none"> Device limits max: Messages are generated when the process variable (e.g. conductivity) is outside the measurement range. The "Failure" icon is displayed, the NAMUR failure contact is activated (BASE module, factory setting: contact K4, N/C contact). The current outputs can signal a 22 mA message (user defined). Variable limits: For the "failure" and "warning" messages you can define upper and lower limits for message generation. Message icons: <ul style="list-style-type: none">  Failure (Failure limit HiHi/LoLo)  Maintenance (Warning limit Hi/Lo)
	 <p>Messages Conductivity (Administrator)</p> <p>Monitoring: Off</p> <p>Device limits max.</p> <p>Variable limits</p> <p>Abort OK</p>	<h3>Diagnostics menu</h3> <p>When the "Maintenance" or "Failure" icons are flashing in the display, you should open the Diagnostics menu. The messages are displayed in the "Message list".</p>
	 <p>Messages (Administrator)</p> <p>Monitoring</p> <p>Variable limits</p> <p>Failure Limit Lo -0.000 µS/cm</p> <p>Warning Limit Lo -0.000 µS/cm</p> <p>Warning Limit Hi +1999 mS/cm</p> <p>Failure Limit Hi +1999 mS/cm</p> <p>Abort OK</p>	
	 <p>Message list</p> <ul style="list-style-type: none"> Fail Temperature range Fail Meas. processing <p>Abort</p>	

Parameter Setting: BASE Module

Menu selection: Parameter Setting > BASE Module

Note: Function check (HOLD) active

Note: The display may vary depending on the device version.

Menu	Display	Action
		<p>Configuring the Current Output</p> <ul style="list-style-type: none"> • Open parameter setting • Enter passcode • Select "Module BASE" • Select "Output current ..."
		<ul style="list-style-type: none"> • Select process variable
		<p>Select Curve, e.g. "Linear": The measured variable is represented by a linear output current curve. The desired range of the measured variable is specified by the values for "Start" and "End". See also: "Minimum span"</p>

Assignment of Measured Values: Start (4 mA) and End (20 mA)

Example 1:
Range 0 ... 1999 mS/cm

Example 2: Range 500 ... 700 mS/cm
Advantage: Higher resolution in range of interest

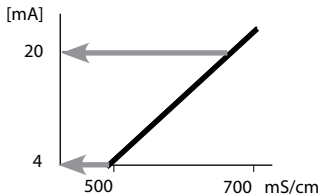
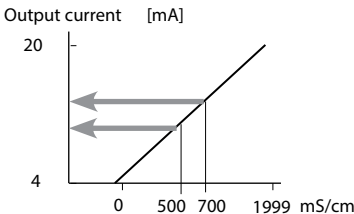

Current Outputs: Characteristics

Menu selection: Parameter setting > BASE module

Note: Function check (HOLD) mode active

- **Linear characteristic**

The process variable is represented by a linear output current curve.

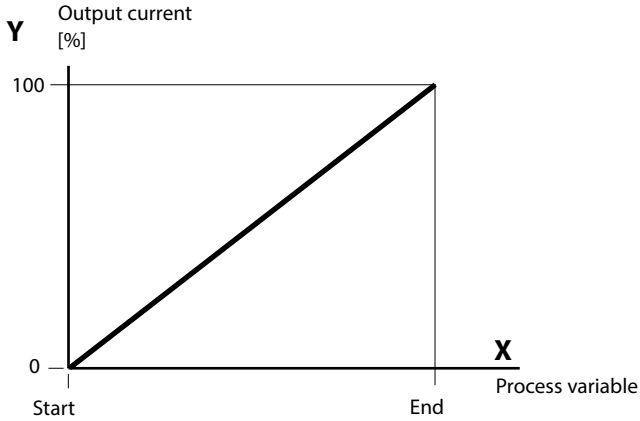

- **Trilinear characteristic**

Two additional vertices must be entered:

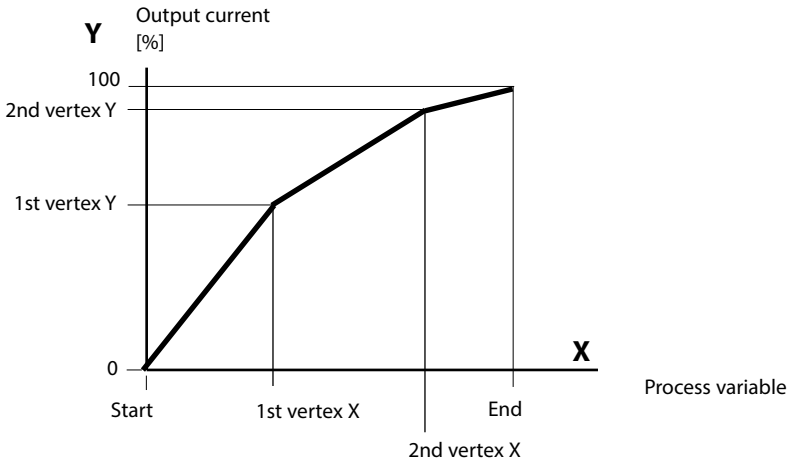

- **Note: Bilinear characteristic**

For a bilinear characteristic, identical parameters are entered for the two vertices (1st vertex, 2nd vertex).

• Function characteristic

Nonlinear output current characteristic: allows measurements over several decades, e.g. measuring very low values with a high resolution and high values with a low resolution.

Required: Entering a value for 50 % output current.

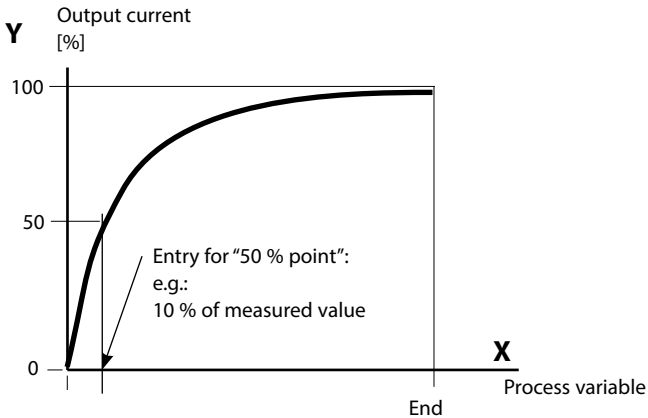

Equation

$$\text{Output current (4 to 20 mA)} = \frac{(1+K)x}{1+Kx} 16 \text{ mA} + 4 \text{ mA}$$

$$K = \frac{E + S - 2 * X50\%}{X50\% - S} \qquad x = \frac{M - S}{E - S}$$

S: Start value at 4 mA

X50%: 50% value at 12 mA (output current range 4 to 20 mA)

E: End value at 20 mA

M: Measured value

Logarithmic output curve over one decade:

S: 10 % of maximum value

X50%: 31.6 % of maximum value

E: Maximum value

Logarithmic output curve over two decades:

S: 1 % of maximum value

X50%: 10 % of maximum value

E: Maximum value

Current Outputs: Output Filter

Parameter setting > BASE module > Output current I... > Output filter

Note: Function check (HOLD) mode active

Time Averaging Filter

To smoothen the current output, a low-pass filter with adjustable time interval can be switched on. When there is a jump at the input (100 %), the output level is at 63 % after the time interval has been reached.

The time interval can be set from 0 to 120 sec. If the time interval is set to 0 sec, the current output follows the input.

Note:

The filter only acts on the current output and the current value of the secondary display, not on the measurement display, the limit values or the controller!

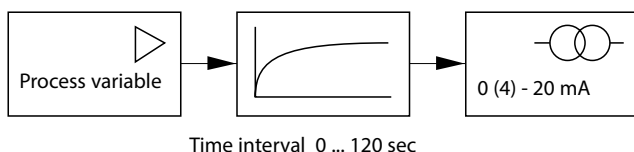

Note:

For further BASE module settings (behavior during messages, contacts, opto-coupler inputs) refer to the user manual of the basic device.

Maintenance

Sensor monitor, temp probe adjustment

Note: Function check (HOLD) mode active

Note: The display may vary depending on the device version.

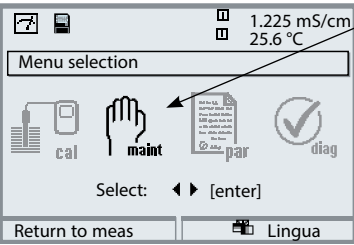
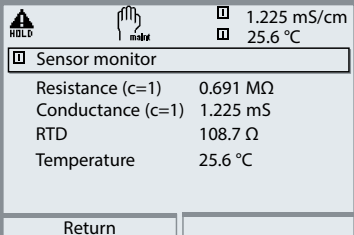
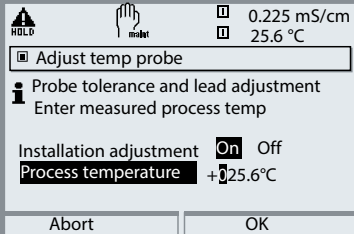

Menu	Display	Action
		<p>Open Maintenance</p> <p>From the measuring mode: Press menu key to select menu. Select maintenance using arrow keys, confirm by pressing enter. Passcode 2958 (The passcode can be edited by the administrator.) Then select CONDI module.</p>
		<p>Sensor Monitor</p> <p>During maintenance, the sensor monitor allows validation of the sensor by immersing it in a known solution, for example, and checking the values measured.</p>
		<p>Temp Probe Adjustment¹⁾</p> <p>This function allows compensating for the individual temperature probe tolerance and the influence of the lead resistances to increase the accuracy of temperature measurement. Make sure that the process temperature is precisely measured using a calibrated reference thermometer when performing an adjustment! The measurement error of the reference thermometer should be less than 0.1 °C. Adjustment without precise measurement might result in considerable deviations of the measured value display!</p>

Diagnostic Functions

General status information of the measuring system

Select menu: Diagnostics

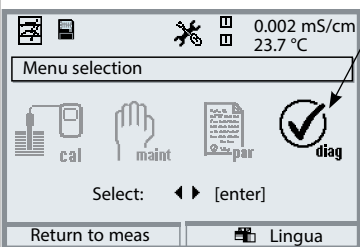
Note: The display may vary depending on the device version.

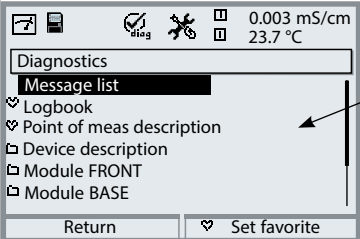
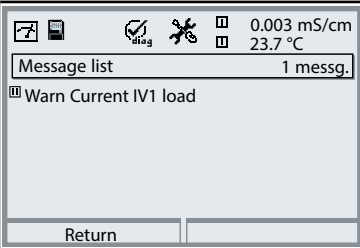
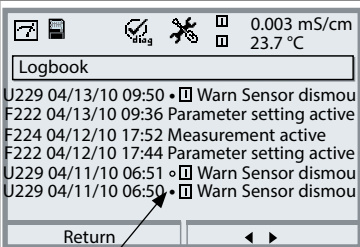
Menu	Display	Action
		<p>Opening the Diagnostics Menu</p> <p>From the measuring mode: Press menu key to select menu. Select diagnostics using arrow keys, confirm by pressing enter.</p>
		<p>The “Diagnostics” menu gives an overview of all functions available. Functions which have been set as “Favorite” can be directly accessed from the measuring mode.</p>
		<p>Point of Meas Description</p> <p>Allows entering a tag number and a note.</p> <p>Select position: left/right arrow key, select character: up/down arrow key. Confirm the entry by pressing enter.</p>
	 <p> <input type="checkbox"/> Releasing module: <ul style="list-style-type: none"> • Message activated ◦ Message deactivated </p>	<p>Logbook</p> <p>Shows the last events¹⁾ with date and time, e.g. calibrations, warning and failure messages, power failure.</p> <p>This permits quality management documentation to ISO 9001. (For parameter setting, see p. 41)</p>

1) Protos 3400(X): 50 events, Protos II 4400(X): 100 events

Diagnostic Functions

Device description, FRONT module, BASE module

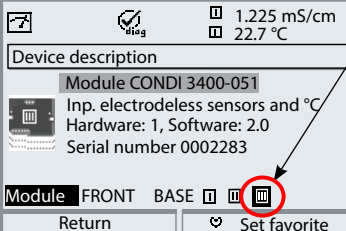
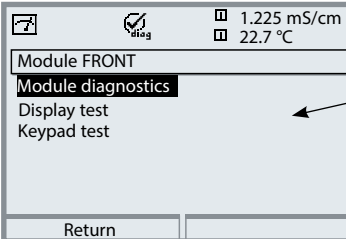
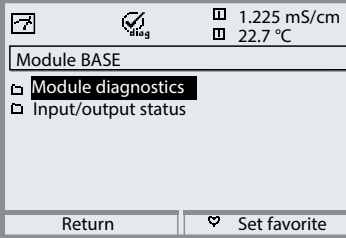
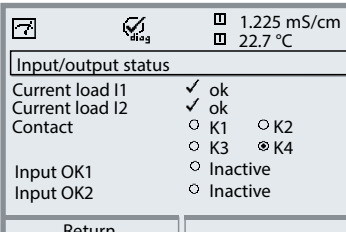

Note: The display may vary depending on the device version.

Menu	Display	Action
		<p>Device Description</p> <p>Select module using arrow keys: Provides information about all modules installed: Function, serial number, hardware and software version and device options.</p>
		<p>FRONT Module</p> <p>The module contains the display and keypad control.</p> <p>Test possibilities:</p> <ul style="list-style-type: none"> • Module diagnostics • Display test • Keypad test
	 	<p>BASE Module</p> <p>The module generates the standard output signals.</p> <p>Test possibilities:</p> <ul style="list-style-type: none"> • Module diagnostics • Input/output status <p>Example: Module BASE, input/output status.</p>

Diagnostic Functions

Menu selection: Diagnostics > COND ... Module
Module diagnostics, sensor monitor, cal record

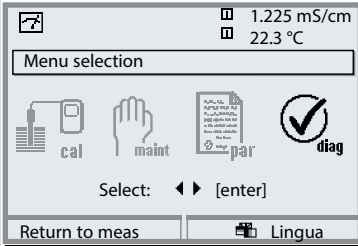
Note: The display may vary depending on the device version.

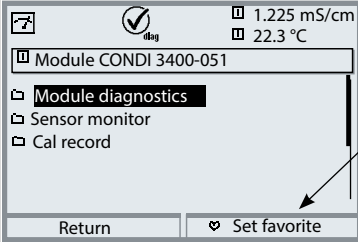
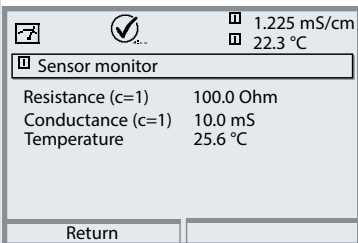
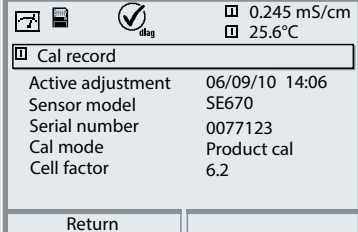
Menu	Display	Action
	 <p>1.225 mS/cm 22.3 °C</p> <p>Menu selection</p> <p>cal maint par diag</p> <p>Select: ◀ ▶ [enter]</p> <p>Return to meas Lingua</p>	<p>Opening the diagnostics menu</p> <p>From the measuring mode: Press menu key to select menu. Select diagnostics using arrow keys, confirm by pressing enter. Then select "Module CONDI".</p>
	 <p>1.225 mS/cm 22.3 °C</p> <p>Module CONDI 3400-051</p> <p>Module diagnostics Sensor monitor Cal record</p> <p>Return Set favorite</p>	<p>The Diagnostics menu gives an overview of all diagnostic functions available. <u>Messages set as "Favorite"</u> can be called up directly from the measuring mode using a softkey. To configure: Parameter setting > System control > Function control matrix.</p>
	 <p>1.225 mS/cm 22.3 °C</p> <p>Sensor monitor</p> <p>Resistance (c=1) 100.0 Ohm Conductance (c=1) 10.0 mS Temperature 25.6 °C</p> <p>Return</p>	<p>Module Diagnostics Internal function test (without Fig.).</p> <p>Sensor Monitor Shows the values currently measured by the sensor. Important function for diagnostics and validation! (cf Maintenance)</p>
	 <p>0.245 mS/cm 25.6 °C</p> <p>Cal record</p> <p>Active adjustment 06/09/10 14:06 Sensor model SE670 Serial number 0077123 Cal mode Product cal Cell factor 6.2</p> <p>Return</p>	<p>Calibration/Adjustment Record Data of the last adjustment/calibration</p> <p>Temp. Offset Log Shows the data from the last temperature adjustment performed on the currently connected sensor.¹⁾</p>

1) with Protos II 4400(X)

Setting Diagnostic Messages as Favorite

Menu selection: Parameter setting > System control > Function control matrix

Secondary displays (1)

Here, additional values are displayed in the measuring mode according to the factory setting. When the respective softkey (2) is pressed, the process variables measured by the modules plus date or time are displayed. In addition, you can use the **softkeys (2)** to control functions.

To assign a function to a softkey, select

Parameter setting/System control/ Function control matrix

Function which can be controlled by softkeys:

- Parameter set selection
- Kl recorder Start/Stop¹⁾
- Favorites
- Unical (fully automated probe controller)¹⁾

Favorites

Selected Diagnostic functions can be called directly from the measuring mode using a softkey.

The table on the next page explains how to select favorites.

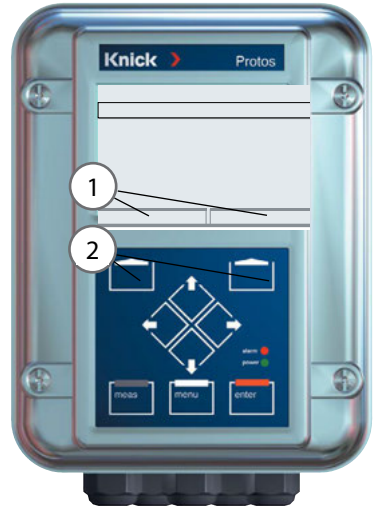

			0245 mS/cm	
			25.6 °C	
Function control matrix (Administrator)				
	ParSet	Kl rec.	♥Fav	Unical
Input OK2	<input type="radio"/>	<input type="radio"/>	-	-
Left softkey	<input type="radio"/>	<input type="radio"/>	-	-
Right softkey	<input type="radio"/>	<input type="radio"/>	<input checked="" type="radio"/>	-
Profibus DO 2	<input type="radio"/>	<input type="radio"/>	-	-
Return		Connect		

Example:

“Favorites” to be selected with
“Right softkey”

To select a softkey function:





Select desired function using arrow keys,
press “Connect” softkey and
confirm with **enter**.

To deselect a function:

Press “Disconnect” softkey,
confirm with **enter**.

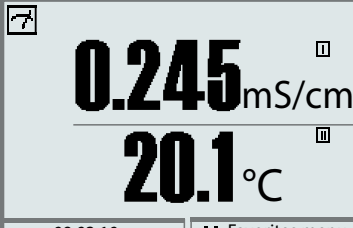
1) With Protos 3400(X)

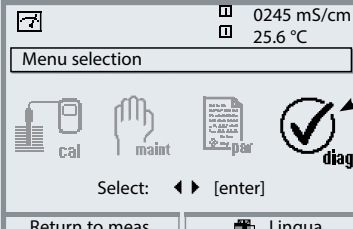
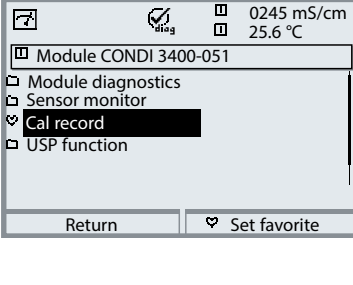
Note: The display may vary depending on the device version.

Menu	Display	Action
		<p>Favorites menu Diagnostic functions can be called directly from the measuring mode using a softkey. The "Favorites" are selected in the Diagnostics menu.</p>
		<p>Select favorites Press menu key to select menu. Select diagnostics using arrow keys, confirm with enter. Then select module and confirm with enter.</p>
		<p>Set/delete favorite: "Set favorite" allows activation of the selected diagnostic function directly from the measuring mode via softkey. The menu line is marked with a heart icon.</p>
		<p>Pressing the meas key returns to measurement. When the softkey has been assigned to "Favorites", "Favorites menu" is read in the secondary display (see "Function control matrix").</p>

Note:



When one of the softkeys has been assigned to the "Favorites menu" function, diagnostic functions which have been set as "Favorite" can be directly called from the measuring mode.

Diagnostic Functions

General status information of the measuring system

Menu selection: Diagnostics > Message list

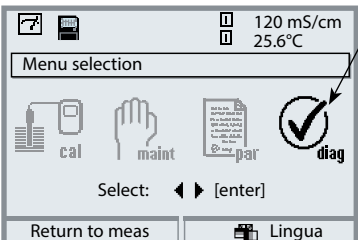
Note: The display may vary depending on the device version.

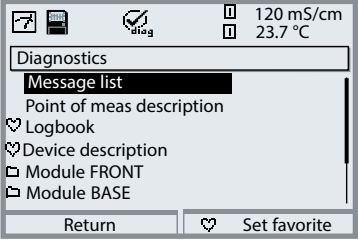
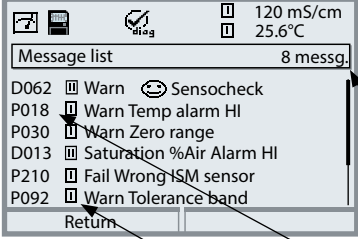
Menu	Display	Action
		<p>Opening the diagnostics menu</p> <p>From the measuring mode: Press menu key to select menu. Select diagnostics using arrow keys, confirm by pressing enter.</p>
		<p>The “Diagnostics” menu gives an overview of all functions available. Functions which have been set as “Favorite” can be directly accessed from the measuring mode.</p>
		<p>Message list</p> <p>Shows the currently activated warning or failure messages in plain text.</p> <p>Number of messages</p> <p>When there are more than 7 messages, a vertical scrollbar appears. Scroll with the up/down arrow keys.</p> <p>Message identifier</p> <p>See message list for description.</p> <p>Module identifier</p> <p>Specifies the module that has generated the message.</p>

Messages

Messages for CONDI 3400(X)-051 Module with Protos 3400(X)

No.	CONDI messages	Message type
T008	Meas. processing (factory settings)	FAIL
T009	Module failure (Firmware Flash check sum)	FAIL
T010	Conductivity range	FAIL / WARN
T011	Conductivity Alarm LO_LO	FAIL
T012	Conductivity Alarm LO	WARN
T013	Conductivity Alarm HI	WARN
T014	Conductivity Alarm HI_HI	FAIL
T015	Temperature range	FAIL
T016	Temperature Alarm LO_LO	FAIL
T017	Temperature Alarm LO	WARN
T018	Temperature Alarm HI	WARN
T019	Temperature Alarm HI_HI	FAIL
T020	Resistivity range	FAIL / WARN
T021	Resistivity Alarm LO_LO	FAIL
T022	Resistivity Alarm LO	WARN
T023	Resistivity Alarm HI	WARN
T024	Resistivity Alarm HI_HI	FAIL
T025	Concentration range	FAIL / WARN
T026	Concentration Alarm LO_LO	FAIL
T027	Concentration Alarm LO	WARN
T028	Concentration Alarm HI	WARN
T029	Concentration Alarm HI_HI	FAIL
T030	Zero range	WARN
T035	Cell factor range	WARN
T040	Salinity range	FAIL / WARN
T041	Salinity Alarm LO_LO	FAIL
T042	Salinity Alarm LO	WARN
T043	Salinity Alarm HI	WARN

Messages

No.	CONDI messages	Message type
T044	Salinity Alarm HI_HI	FAIL
T045	Conductance range	FAIL
T050	Man. temperature range	FAIL
T060	SAD SENSOFACE: Primary coil	User-defined
T061	SAD SENSOFACE: Secondary coil	User-defined
T062	SAD SENSOFACE: SensoLoop	User-defined
T130	SIP cycle counted	Text
T131	CIP cycle counted	Text
T200	Reference temperature	WARN
T201	TC correction	WARN
T202	TC range	WARN
T203	TC range	FAIL
T204	Sensor coding	WARN
T205	Cal: Sensor unstable	Text
T254	Module reset	Text

Messages

Messages for CONDI 3400(X)-051 Module with Protos II 4400(X)

 Failure
  Out of Specification
  Maintenance Required

No.	Message Type	CONDI Messages
T008	Failure	Meas. Processing (Factory Settings)
T009	Failure	Firmware Error
T010	User-defined	Conductivity Range
T011	Failure	Conductivity Alarm LO_LO
T012	Out of Specification	Conductivity Alarm LO
T013	Out of Specification	Conductivity Alarm HI
T014	Failure	Conductivity Alarm LO_LO
T015	Failure	Temperature Range
T016	Failure	Temperature Alarm LO_LO
T017	Out of Specification	Temperature Alarm LO
T018	Out of Specification	Temperature Alarm HI
T019	Failure	Temperature Alarm HI_HI
T020	User-defined	Resistivity Range
T021	Failure	Resistivity Alarm LO_LO
T022	Out of Specification	Resistivity Alarm LO
T023	Out of Specification	Resistivity Alarm HI
T024	Failure	Resistivity Alarm HI_HI
T025	User-defined	Concentration Range
T026	Failure	Concentration Alarm LO_LO
T027	Out of Specification	Concentration Alarm LO
T028	Out of Specification	Concentration Alarm HI
T029	Failure	Concentration Alarm LO_LO
T040	Failure	Salinity Range
T041	Failure	Salinity Alarm LO_LO
T042	Out of Specification	Salinity Alarm LO
T043	Out of Specification	Salinity Alarm HI
T044	Failure	Salinity Alarm HI_HI
T045	Failure	Conductance Range
T060	User-defined	Sad Sensoface: Primary Coil
T061	User-defined	Sad Sensoface: Secondary Coil
T063	Maintenance Required	Sad Sensoface: Zero Point
T064	Failure/Maintenance Required	Cell Factor

Messages

No.	Message Type	CONDI Messages
T070	Failure	TDS Range
T071	Failure	TDS Alarm LO_LO
T072	Out of Specification	TDS Alarm LO
T073	Out of Specification	TDS Alarm HI
T074	Failure	TDS Alarm HI_HI
T110	Maintenance Required	CIP Counter
T111	Maintenance Required	SIP Counter
T130	Info	SIP Cycle Counted
T131	Info	CIP Cycle Counted
T200	Out of Specification	Reference Temperature
T201	Out of Specification	Temp Compensation
T202	Out of Specification	TC Range
T203	Failure	TC Range (Failure)
T204	Maintenance Required	Sensor Coding
T205	Info	Cal: Sensor Unstable
T254	Info	Module Reset

Specifications

Specifications Protos CONDI 3400(X)-051

Condl input	For SE 655 / SE 656 toroidal sensors (and others)
Measuring range (SE 655 / SE 656)	0000 μ S/cm ... 1999 mS/cm, resolution 1 μ S/cm
Concentration	0.00 ... 100.0 wt%
Salinity	0.0 ... 45.0 g/kg (0 ... 35 °C)
Response time (t_{90})	< 0.5 sec
Measurement error ²⁾	< 0.5 % meas. val. +2 μ S/cm
Perm. cable length	Max. 20 m

Temp compensation ¹⁾	- Without - Linear characteristic 00.00 ... 19.99 %/K (reference temp user-defined) - NLF nat. waters according to EN 27888 (reference temp 225 °C / 77 °F)
--	---

Temperature input

Temperature probe ¹⁾	Pt 100/Pt 1000/NTC 30 k Ω /NTC 100 k Ω 3-wire connection, adjustable
Measuring range (MR)	Pt100 / Pt1000: -50 ... 250 °C / -58 ... 482 °F NTC 30 k Ω / NTC 100 k Ω : -10 ... 150 °C / 14 ... 302 °F
Resolution	0.1 °C
Measurement error ³⁾	0.2 % meas.val. + 0.5 K

Concentration determination¹⁾

(SW3400-009/FW4400-009)	For the substances:
	HNO ₃ 0 ... 30 wt% -20 ... 50 °C / -4 ... 122 °F 35 ... 96 wt% -20 ... 50 °C / -4 ... 122 °F
	HCl 0 ... 18 wt% -20 ... 50 °C / -4 ... 122 °F 22 ... 39 wt% -20 ... 50 °C / -4 ... 122 °F
	H ₂ SO ₄ 0 ... 37 wt% -17.8 ... 110 °C / -0.04 ... 230 °F 28 ... 88 wt% -17.8 ... 115.6 °C / -0.04 ... 240.08 °F 89 ... 99 wt% -17.8 ... 115.6 °C / -0.04 ... 240.08 °F

Specifications

NaOH	0 ... 24 wt%	0 ... 100 °C / 32 ... 212 °F
	15 ... 50 wt%	0 ... 100 °C / 32 ... 212 °F
NaCl	0 ... 28 wt%	0 ... 100 °C / 32 ... 212 °F
H ₂ SO ₄ •SO ₃ (Oleum)	12 ... 45 wt%	0 ... 120 °C / 32 ... 248 °F
User-defined concentration table (5x5 values)		

Sensor monitoring¹⁾ Sensocheck, monitoring of primary and its lines for short circuit and of secondary and its lines for open circuit

Sensoface Provides information on the sensor condition

Sensor standardization¹⁾ Operating modes

- Automatic calibration with KCl or NaCl solution
- Manual: Entry of cell factor with simultaneous display of conductivity and temperature
- Product calibration / adjustment to vessel
- Data entry of premeasured sensors
- Adjustment of zero point

Permissible cell factor 0 ... 19.99 cm⁻¹

Permissible transfer ratio 0.00 ... 199.9

Calibration record Recording of:
Cell factor, transfer ratio, zero point,
calibration method with date and time

Output curves¹⁾ Linear
Trilinear
Function (logarithmic)
As desired via table

1) User-defined

2) Rated operating conditions, ± 1 count

3) Rated operating conditions, ± 1 count, with NTC > 100 °C/212 °F: 0.2 % meas.val. + 1 K

Specifications

General Data

Explosion protection (Ex version of module only)	For entity parameters, see attachment to certificates or control drawings.
RoHS conformity	According to EU directive 2011/65/EU
EMC	EN 61326-1, EN 61326-2-3 NAMUR NE 21
Emitted interference	Industrial applications ¹⁾
Interference immunity	(EN 55011 Group 1 Class A) Industrial applications
Lightning protection	to EN 61000-4-5, Installation class 2
Rated operating conditions (module installed)	
Ambient temperature	Safe area: -20 ... 55 °C / -4 ... 131 °F Ex: -20 ... 50 °C / -4 ... 122 °F
Relative humidity	5 ... 95 %
Climatic class	3K5 according to EN 60721-3-3
Location class	C1 according to EN 60654-1
Transport/storage temperature	-20 ... 70 °C / -4 ... 158 °F
Screw clamp connectors	Single or stranded wires 0.2 ... 2.5 mm ² Tightening torque 0.5 ... 0.6 Nm
Wiring	Stripping length max. 7 mm Temperature resistance > 75 °C / 167 °F

1) This equipment is not designed for domestic use, and is unable to guarantee adequate protection of the radio reception in such environments.

Appendix

Minimum Spans for Current Outputs

The CONDI 3400(X)-051 module is a measuring module. It does not provide current outputs. Current outputs are provided by the BASE module (basic device) or by communication modules (e.g. OUT module). The corresponding parameters must be set there.

The minimum current span shall prevent that the resolution limit of the measurement technology (± 1 count) is seen in the current.

CONDI 3400(X)-051 Module

S/cm	20 %, min. 100.0 μ S/cm
wt%	1.00
°C	10.0
g/kg	1.00
Ohm*cm	20 %, min. 100.0 ohms*cm
°F	10.0

Calculation Block COND/COND

Diff S/cm	20 %, min. 100.0 μ S/cm
Diff °C	10.0
Diff Ohm*cm	20 %, min. 100.0 ohms*cm
RATIO	0.10
PASSAGE	10.0
REJECTION	10.0
DEVIATION	10.0

Overview

Overview of Parameter Setting

Parameter Setting Menu

Note: The menus may vary depending on the device version

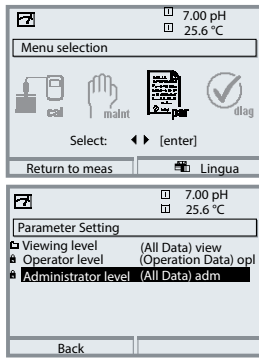

Parameter Setting

From measuring mode: Press **menu** key to select menu. Select parameter setting using arrow keys, press **enter** to confirm.

Administrator level

Access to all functions, also passcode setting. Releasing or blocking functions for access from the Operator level.

Operator level

Access to all functions which have been released at the Administrator level. Blocked functions are displayed in gray and cannot be edited.

Viewing level

Only display, no editing possible!

System Control

Memory card (Option)	Menu only appears when a memory card is inserted and the corresponding add-on function has been enabled.
Transfer configuration	The complete configuration of a device can be written on a memory card. This allows transferring all device settings to other devices with identical equipment (exception: options and passcodes).
Parameter set	2 parameter sets (A, B) are available in the device. The currently active parameter set is shown in the display. Parameter sets contain all settings except: sensor type, options, system control settings Up to 5 parameter sets (1, 2, 3, 4, 5) are available when a memory card (Option) is used.
Function control	Select the functions to be controlled via softkeys and OK inputs
Time/date	Time, date, display format
Meas. point description	Free input of a tag number, can be called from the diagnostics menu
Release of options	Option activation via TAN
Reset to default	Reset all parameters to factory setting
Passcode entry	Change passcodes
Firmware update	Update the firmware using an Update Card
Logbook	Select the events to be recorded

Overview

Overview of Parameter Setting

Parameter Setting Menu



FRONT Module: Display Settings

Language	Select the menu language
Units ¹⁾	Select the measurement units
Formats ¹⁾	Select the display format
Measurement display	Representation of measured values on the display
Display	Brightness/contrast, auto-off

BASE Module: Signal Outputs and Inputs, Contacts

Output current I1, I2	Separately adjustable current outputs
Contact K4	Failure signaling
Contacts K3, K2, K1	Separately adjustable relay contacts
Inputs OK1, OK2	Optocoupler signal inputs

Note: The menu may vary depending on the device version

1) With Protos II 4400(X) only

Parameter Setting Menu



CONDI 3400(X)-051 Module

Input filter

Sensor data

- Sensor type
- Sensor coding
- Nom. cell factor
- Transfer ratio
- Temperature detection
 - Measuring temp
 - Cal temp
- Sensocheck

Representation of measured values on the display:

- Select
- Selection for Measurement / Calibration

Protos 3400(X):

Cal preset values

- Cal solution
- Product calibration

Select the calibration solution (NaCl 0.01 mol/l, NaCl 0.1 mol/l, NaCl saturated, KCl 0.01 mol/l KCl 0.1 mol/l, KCl 1 mol/l)

Product calibration without/with temperature compensation

Protos II 4400(X):

Cal Presettings

Calibration Mode

- Cal. Solution

Automatic, Manual, Product, Data Entry, Temperature

Automatic: Select cal. solution (NaCl 0.01 mol/l, NaCl 0.1 mol/l, NaCl saturated, KCl 0.01 mol/l KCl 0.1 mol/l, KCl 1 mol/l)

Product: Conductivity, Concentration ¹⁾

- Conductivity

Product Calibration, Conductivity: With/Without TC

- Medium

Product Calibration, Concentration ¹⁾: Select the medium

TC process medium

Set the temperature compensation
(off, linear, EN 27888, ultrapure water ²⁾)

Concentration ¹⁾

Messages

- Conductivity
- Resistivity
- Concentration ¹⁾
- Temperature
- Salinity

Off, Max. device limits, Variable limits

Note: The menus may vary depending on the device version.

Calibration Menu



CONDI 3400(X)-051 Module

Automatic
 Calibration solution input
 Product calibration
 Data entry
 Zero correction
 Temp probe adjustment ¹⁾ Compensating for lead length

Maintenance Menu



BASE Module

Current source Output current definable 0 ... 22 mA

CONDI 3400(X)-051 Module

Sensor monitor For validation of sensor and complete signal processing
 Temp probe adjustment ²⁾ Compensating for lead length

Diagnostics Menu



Message list List of all messages
 Point of meas description Shows the tag number and annotation
 Logbook Shows the last events with date and time
 Device description Hardware version, Serial no., (Module) Firmware, Options

FRONT Module

Module diagnostics
 Display test
 Keypad test

BASE Module

Module diagnostics
 Input/output status

CONDI 3400(X)-051 Module

Module diagnostics Internal function test
 Sensor monitor Shows the values currently measured by the sensor
 Cal./Adj. record Data of last adjustment / calibration
 Temp. offset log ¹⁾

1) with Protos II 4400(X) 2) with Protos 3400(X)

Note: The menus may vary depending on the device version.

Index

A	
Adjusting the temperature probe (Protos 3400).....	48
Adjusting the temperature probe (Protos II 4400)	26
Adjustment.....	14
Administrator level	28
Application in hazardous locations.....	6
Automatic calibration with standard calibration solution.....	18
Automatic temperature compensation	15
B	
BASE module, parameter setting	44
Behavior during messages	47
Bilinear characteristic.....	45
C	
Calculation Blocks	38
Calibration	13
Calibration/adjustment record.....	51
Cal preset values.....	31
Cal record	51
Concentration.....	33
Concentration curves	33
Concentration table	37
Configuring the current outputs.....	44
Connecting the module	9
Contact assignments	8
Contacts, parameter setting.....	47
Corrective maintenance	6
Current outputs	44
Current outputs, characteristics.....	45
Current outputs, minimum spans.....	63

Index

D	
Data entry of premeasured sensors	24
Device description, diagnostics menu	50
Device firmware	7
Device limits max	43
Diagnostic messages	55
Diagnostic messages as favorite	52
Diagnostics	49
Disposal	2
E	
Electrostatic discharge (ESD)	9
EMC	61
Error messages	55
Explosion protection, safety instructions.....	6
F	
Factory setting	41
Favorites.....	52
Firmware version	7
Function control matrix	52
H	
Hardware/Firmware version.....	7
Hydrochloric acid	34
I	
Installing the module	9
Intended use	5
L	
Linear characteristic	45
Lock icon.....	29
Locking a function	29
Logarithmic output curve	46
Logbook, diagnostics menu.....	49
Logbook (parameter setting).....	41

Index

M

Maintenance menu	48
Manual entry of cal solution	20
Measuring point description	49
Message icons	43
Message list.....	54
Messages	43
Messages with Protos 3400(X)	55
Messages with Protos II 4400(X).....	57
Minimum spans for current outputs.....	63
Module compatibility	7
Module diagnostics.....	51
Module firmware.....	7
Module installation.....	9

N

Nitric acid	34
-------------------	----

O

Oleum.....	36
Open parameter setting	30
Operating levels.....	28
Operator level.....	28
Optocoupler inputs	47
Output filter.....	47
Overview of parameter setting.....	64

P

Parameter setting.....	28
Parameter setting, overview	64
Parameter setting: TC process medium	31
Point of meas description	49
Preparing the special cable	10
Product calibration	22

Index

R	
Rated operating conditions.....	61
Release (softkey function).....	29
Restore factory settings.....	41
Returns.....	2
S	
Safety Instructions.....	6
Salt solution.....	35
Secondary displays.....	52
Sensor connection.....	10, 11
Sensor monitor, diagnostics menu.....	51
Sensor monitor, maintenance menu.....	48
Serial number, display.....	7
Shield connection.....	10
Sodium hydroxide solution.....	35
Softkeys, function control.....	52
Specifications.....	59
Sulfuric acid.....	33
T	
Table of contents.....	3
TC correction.....	32
Technical data.....	59
Temperature compensation during calibration.....	15
Temp. offset log.....	51
Temp probe adjustment (Protos 3400).....	48
Temp probe adjustment (Protos II 4400).....	26
Terminal plates.....	8
Trilinear characteristic.....	45

Index

U	
Ultrapure water	32
V	
Variable limits	43
Viewing level.....	28
W	
Wiring examples.....	11
Z	
Zero correction.....	25



Knick
Elektronische Messgeräte
GmbH & Co. KG

Headquarters

Beuckestraße 22 • 14163 Berlin

Germany

Phone: +49 30 80191-0

Fax: +49 30 80191-200

info@knick.de

www.knick.de

Local Contacts

www.knick-international.com

Copyright 2020 • Subject to change

Version: 10

This document was published on November 13, 2020.

The latest documents are available for download on our website
below the corresponding product description.



097701

TA-201.051-KNEN10

Firmware version: 2.x