

Protos II 4400(X) / Protos 3400(X) Process Analysis System

User Manual

Protos OUT 3400(X)-071 Communication Module
Output Module with 2 Current Outputs and
4 Relay Outputs

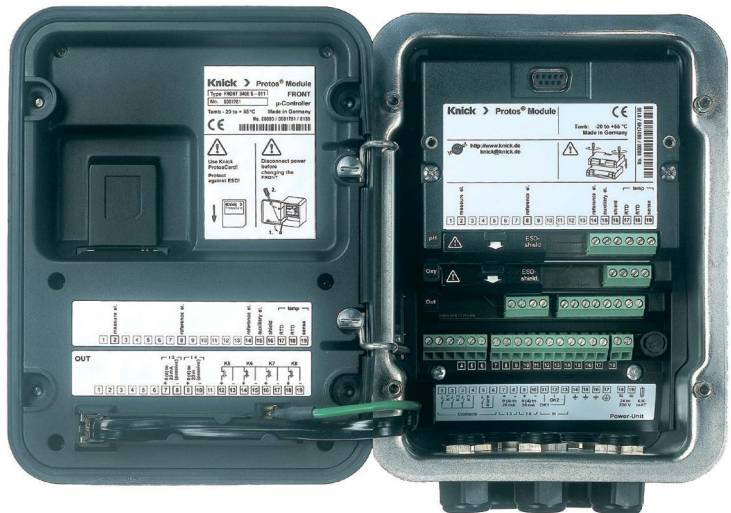

Returns

Please contact our Service Team before returning a defective device. Ship the cleaned device to the address you have been given.

If the device has been in contact with process medium, it must be decontaminated/disinfected before shipment. In this case, place a Declaration of Contamination in the consignment to prevent any risk to the health and safety of our service personnel. The declaration is available at:



<https://www.knick-international.com/en/service/repairs/>

Disposal

Please observe the applicable local or national regulations concerning the disposal of "waste electrical and electronic equipment".

Trademarks

The following trademarks are used in this document without further marking:

Calimatic®, Protos®, Sensocheck®, Sensoface®, Unical®, VariPower®, Ceramat®, SensoGate® are registered trademarks of Knick Elektronische Messgeräte GmbH & Co. KG, Germany

Memosens®

is a registered trademark of

Endress+Hauser Conducta GmbH & Co. KG, Germany

Knick Elektronische Messgeräte GmbH & Co. KG, Germany

Table of Contents

Returns	2
Disposal	2
Trademarks	2
Intended Use	5
Safety Instructions	6
Operation in Explosive Atmospheres: OUT 3400X-071 Module.....	6
Firmware Version	7
Terminal Plate OUT 3400-071 Module.....	8
Installing the Module.....	9
Wiring Examples	10
Parameter Setting	13
Parameter Setting: Operating Levels	14
Parameter Setting: Locking a Function	15
Activating Parameter Setting	16
Messages: Default settings and selection range	19
Current Outputs.....	21
Assignment of Measured Values: Start (4 mA) and End (20 mA).....	21
Configuring the current output.....	21
Current Outputs: Characteristics	22
Current Outputs: Output Filter.....	24
Limit Value, Hysteresis, Contact Type.....	25
Icons in the Measurement Display	25
Maintenance, Diagnostics	26
Opening the diagnostics menu	27
Message list	27
Specifications.....	30
Overview	32
Overview of Parameter Setting.....	32
Index.....	36

Intended Use

The module provides 2 passive current outputs for transmission of any desired process variables and 4 electronic relay outputs for limit monitoring.

The OUT 3400X-071 module is intended for operation in locations subject to explosion hazards which require equipment of Group II, device category 2(1), gas/dust.

Safety Instructions

Operation in Explosive Atmospheres: OUT 3400X-071 Module

The module is approved for operation in explosive atmospheres.

When installing the product in a hazardous location, observe the information in the supplements to the certificates and, if applicable, the relevant control drawings.

Observe all applicable local and national codes and standards for the installation of electrical equipment in explosive atmospheres. For orientation, please refer to IEC 60079-14, EU directives 2014/34/EU and 1999/92/EC (ATEX), NFPA 70 (NEC), ANSI/ISA-RP12.06.01.

⚠ WARNING! Risk of impairment of explosion protection.

- Modules which have already been used shall be subjected to a professional routine test before they may be operated in another type of protection.
- Prior to commissioning, the operating company must verify the intrinsic safety in accordance with the installation regulations of IEC 60079-14 for the complete interconnection of all equipment involved, including the connecting cables.
- The interconnection of Ex and non-Ex modules (mixed assembly) is not permitted.
- In hazardous locations the device shall only be cleaned with a damp cloth to prevent electrostatic charging.

Maintenance

The Protos modules cannot be repaired by the user. For inquiries regarding module repair, please contact Knick Elektronische Messgeräte GmbH & Co. KG at www.knick.de.

Firmware Version

Module Firmware OUT 3400(X)-071: firmware version 1.x

Module Compatibility	OUT 3400-071	OUT 3400X-071
Protos 3400 from FRONT firmware version 3.0	x	
Protos 3400X from FRONT firmware version 4.0		x
Protos II 4400 from FRONT firmware version 01.00.00	x	
Protos II 4400X from FRONT firmware version 01.00.00		x

Query actual device/module firmware

When the analyzer is in measuring mode:

Press **menu** key, open Diagnostics menu: Device description

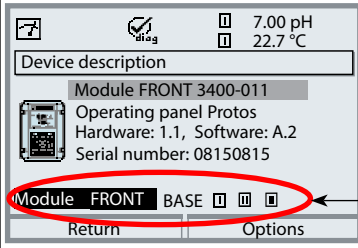
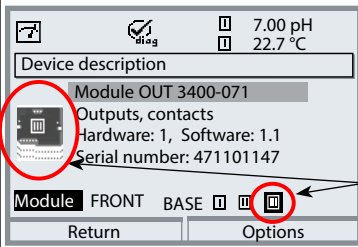
Menu	Display	Device description
 diag	 <p>Device description</p> <p>Module FRONT 3400-011</p> <p>Operating panel Protos</p> <p>Hardware: 1.1, Software: A.2</p> <p>Serial number: 08150815</p> <p>Module FRONT BASE [] [] []</p> <p>Return Options</p>	Device hardware and firmware version Provides information on all modules installed: Module type and function, serial number, hardware and firmware version and device options. Select the different modules (FRONT, BASE, slots 1 - 3) using the arrow keys.
	 <p>Device description</p> <p>Module OUT 3400-071</p> <p>Outputs, contacts</p> <p>Hardware: 1, Software: 1.1</p> <p>Serial number: 471101147</p> <p>Module FRONT BASE [] [] []</p> <p>Return Options</p>	Query module firmware Module OUT 3400-071, hardware and firmware version, serial number – here installed in slot 3.

Note: The display may vary depending on the device version.

Terminal Plate OUT 3400-071 Module

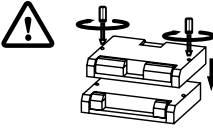
Knick > Protos[®] Module	CE											
Type OUT 3400-071	OUT											
No. _____	analog / digital											
	Tamb: -20 to +55 °C Made in Germany											
Internet http://www.knick.de knick@knick.de												
DC, max. 30 V/100 mA												
I3	I4	K5	K6	K7	K8							
+ 0 (4) to 20 mA	- (passive)	+	-	+	-	+	-					
7	8	9	10	11	12	13	14	15	16	17	18	19

Attaching the Terminal Plates

The terminal plates of the lower modules can be stuck to the inner side of the door. This facilitates maintenance and service.



Installing the Module

⚠ CAUTION! Electrostatic discharge (ESD).

The modules' signal inputs are sensitive to electrostatic discharge.

Take measures to protect against ESD before inserting the module and wiring the inputs.

Note: Strip the insulation from the wires using a suitable tool to prevent damage.



- 1) Switch off the power supply to the device.
- 2) Open the device (loosen the 4 screws on the front).
- 3) Plug the module into the slot (D-SUB connector), see figure.
- 4) Tighten the module's fastening screws.
- 5) Connect the signal lines, see "Wiring Examples".
- 6) Check whether all connections are correctly wired.
- 7) Close the device by tightening the screws on the front.
- 8) Switch on the power supply.

⚠ CAUTION! Incorrect measurement results.

Incorrect parameter setting, calibration or adjustment may result in incorrect measurements being recorded. Protos must therefore be commissioned by a system specialist, all its parameters must be set, and it must be fully adjusted.

Wiring Examples

Current Output, Relay Contacts

Wiring Example 1

(one output)

Current output I3 or I4 (passive, supply unit required)

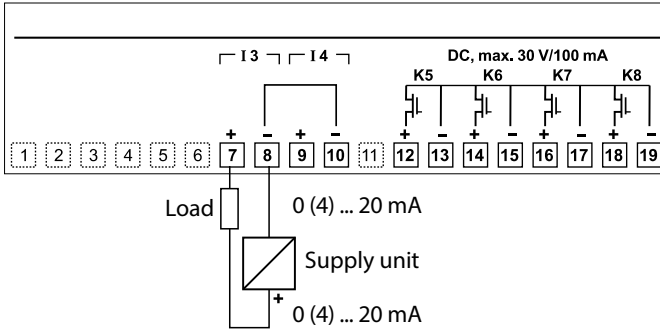

Wiring Example 2

Electronic relay contacts

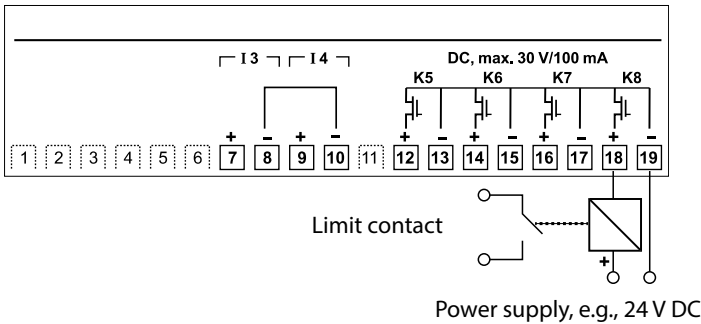

Wiring Examples

Current Output, Relay Contacts

Wiring Example 3

(two outputs: feeding PLC with common positive pole)

Current outputs I3 and I4 (two loop-powered supplies)

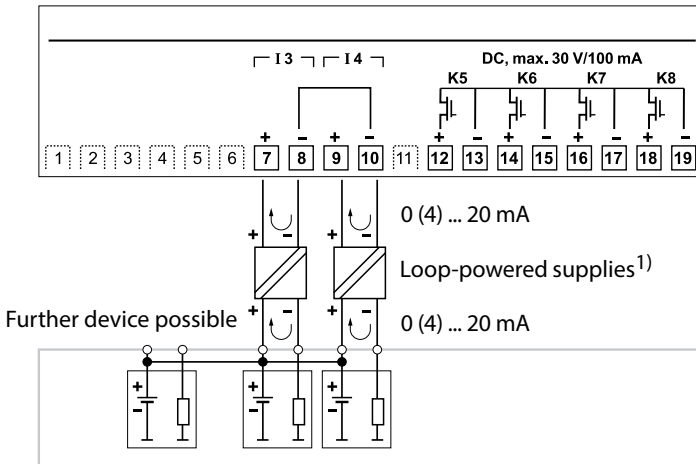

Note:

- The module's current outputs are passive and must be supplied with power.
- Observe the polarity.
- Note when wiring:
The negative poles of the OUT 3400(X)-071 module are internally connected.

Wiring Examples

Current Output, Relay Contacts

Wiring Example 4

(two outputs: feeding PLC with common positive pole)

Current outputs I3 and I4 (one loop-powered supply)

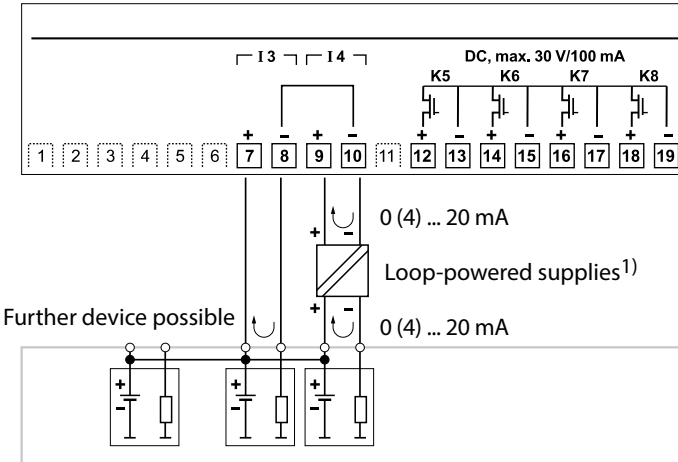

NOTICE! When using only one loop-powered supply and connecting more devices, make sure that the device potentials are properly isolated.

1) e.g., loop-powered isolator for standard signals
P22401 (1 channel) or P22402 (2 channels)

For explosive atmospheres:

WG 25 A7 loop-powered supply

Parameter Setting

⚠ CAUTION!

Incorrect parameter setting, calibration or adjustment may result in incorrect measurements being recorded. Protos must therefore be commissioned by a system specialist, all its parameters must be set, and it must be fully adjusted.

NOTICE!

The "function check" (HOLD) mode is active during parameter setting. The behavior of the current outputs depends on the parameter setting, i.e., they may be frozen at the last measurement or set to a fixed value. The red "Alarm" LED blinks.

Measurement operations must not be carried out while the Protos is in the function check (HOLD) mode, as this may put the user at risk due to unexpected system behavior.

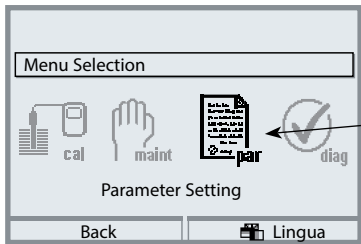
Menü	Display	Aktion
		Open the Parameter Setting menu From the measuring mode: Press menu key to select menu. Select parameter setting using arrow keys, press enter to confirm

Parameter Setting: Operating Levels

Viewing level, Operator level, Administrator level

Note: Function check (HOLD) mode active (Setting: BASE module)

Note: The display may vary depending on the device version.

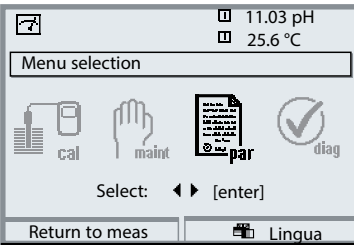
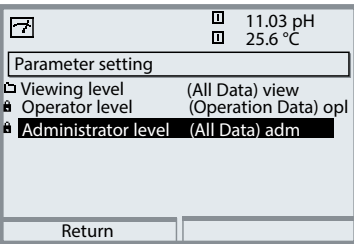
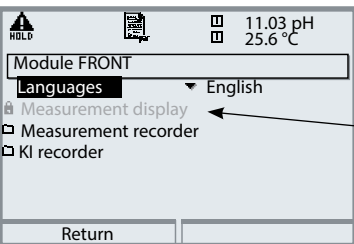

Menu	Display	Viewing level, Operator level, Administrator level
	<p>11.03 pH 25.6 °C</p> <p>Menu selection</p> <p>cal maint par diag</p> <p>Select: ◀ ▶ [enter]</p> <p>Return to meas Lingua</p>	<p>Open parameter setting</p> <p>From the measuring mode: Press menu key to select menu. Select parameter setting using arrow keys, press enter to confirm.</p>
	<p>11.03 pH 25.6 °C</p> <p>Parameter setting</p> <p>Viewing level (All Data) view Operator level (Operation Data) opl Administrator level (All Data) adm</p> <p>Return</p>	<p>Administrator level</p> <p>Access to all functions, also passcode setting. Releasing or blocking a function for access from the Operator level.</p> <p>Functions which can be blocked for the Operator level are marked with the "lock" symbol. The functions are released or blocked using the softkey.</p>
	<p>HOLD 11.03 pH 25.6 °C</p> <p>Module FRONT (Administrator)</p> <p>Languages English Measurement display Measurement recorder KI recorder</p> <p>Return Release</p>	<p>Operator level</p> <p>Access to all functions which have been released at the Administrator level. Blocked functions are displayed in gray and cannot be edited (Fig.).</p> <p>Viewing level</p> <p>Display of all settings. No editing possible!</p>

Parameter Setting: Locking a Function

Administrator level: Enabling/locking functions for Operator level

Note: Function check (HOLD) mode active (Setting: BASE module)

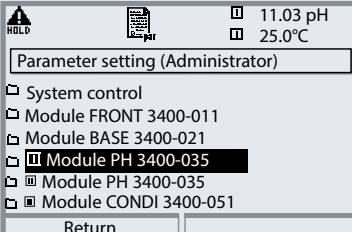
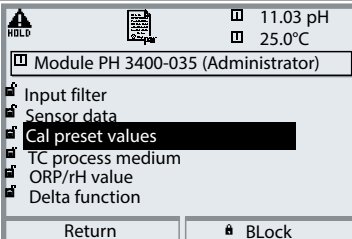
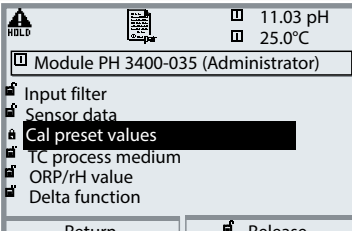
Note: The display may vary depending on the device version.

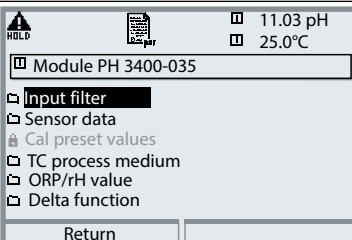
Menu	Display	Administrator level: Enable / lock functions
		<p>Example: Blocking access to the calibration adjustments from the Operator level</p> <p>Open parameter setting Select Administrator level. Enter passcode (1989). Select “Module PH” (e.g.) using arrow keys, press enter to confirm.</p>
		<p>Select “Cal preset values” using arrow keys. “Block” with softkey.</p>
		<p>Now, the “Cal preset values” line is marked with the “lock” icon. This function cannot be accessed from the Operator level any more. The softkey function changes to “Release”.</p>
		<p>Open parameter setting Select <u>Operator level</u>, passcode (1246). Select “Module PH”. Now, the locked function is displayed in gray and marked with the “lock” icon.</p>

Activating Parameter Setting

Note: The display may vary depending on the device version.

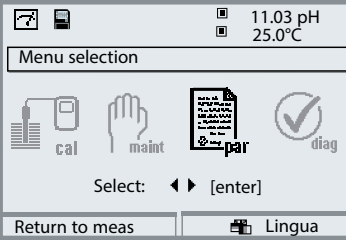
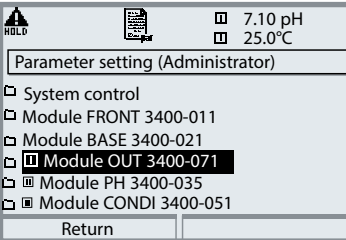
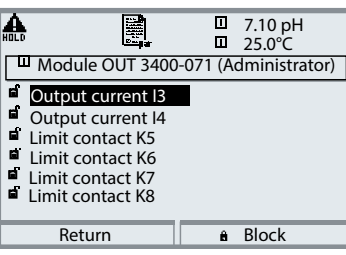
Menu	Display	Parameter setting
		<p>Open parameter setting From the measuring mode: Press menu key to select menu. Select parameter setting using arrow keys, press enter to confirm. Passcode 1989 (To change passcode: Parameter setting/System control/Passcode entry).</p>
		<p>Select module, press enter to confirm.</p>
		<p>Select parameter using arrow keys, press enter to confirm.</p>

During parameter setting the analyzer is in function check (HOLD) mode:
 Current outputs and relay contacts behave as configured (BASE module).

Parameter Setting

Default Settings and Selection Range

Note: HOLD mode

Parameter	Default	Selection / Range
Output current I3 <ul style="list-style-type: none"> • Process variable • Characteristic • Output • Output filter Behavior during messages <ul style="list-style-type: none"> • HOLD • 22 mA message 	Off Linear 4 ... 20 mA 0000 sec Last usable value On	Depending on modules installed: Off, S/cm, °C, % by wt, g/kg, Ωcm, pH, ORP, rH, etc. Linear, trilinear, function, table 0 ... 20 mA, 4 ... 20 mA XXXX sec Current meas., Last usable value, Fixed 22mA On, Off
Output current I4 <ul style="list-style-type: none"> • Process variable • Characteristic • Output • Output filter Behavior during messages <ul style="list-style-type: none"> • HOLD • 22 mA message 	Off Linear 4 ... 20 mA 0000 sec Last usable value On	Depending on modules installed: Off, S/cm, °C, % by wt, g/kg, Ωcm, pH, ORP, rH, etc. Linear, trilinear, function, table 0 ... 20 mA, 4 ... 20 mA XXXX sec Current meas., Last usable value, Fixed 22mA On, Off

Note: The menus may vary depending on the device version

Parameter	Default	Selection / Range
Limit contact K5 • Process variable • Limit value • Hysteresis • Effective direction • Contact type • ON delay • OFF delay	(Module) (Module) (Module) Min N/O 0000 sec 0000 sec	Depending on modules installed: Off, S/cm, °C, % by wt, g/kg, Ωcm, pH, ORP, rH, etc. Entry Entry Min, Max Normally open N/O, normally closed N/C XXXX entry XXXX entry
Limit contact K6 • Process variable • Limit value • Hysteresis • Effective direction • Contact type • ON delay • OFF delay	(Module) (Module) (Module) Min N/O 0000 sec 0000 sec	Depending on modules installed: Off, S/cm, °C, % by wt, g/kg, Ωcm, pH, ORP, rH, etc. Entry Entry Min, Max Normally open N/O, normally closed N/C XXXX entry XXXX entry
Limit contact K7 • Process variable • Limit value • Hysteresis • Effective direction • Contact type • ON delay • OFF delay	S/cm 07.00 μS/cm 0.100 μS/cm Min N/O 0000 sec 0000 sec	Depending on modules installed: Off, S/cm, °C, % by wt, g/kg, Ωcm, pH, ORP, rH, etc. Entry Entry Min, Max Normally open N/O, normally closed N/C XXXX entry XXXX entry
Limit contact K8 • Process variable • Limit value • Hysteresis • Effective direction • Contact type • ON delay • OFF delay	(Module) (Module) (Module) Min N/O 0000 sec 0000 sec	Depending on modules installed: Off, S/cm, °C, % by wt, g/kg, Ωcm, pH, ORP, rH, etc. Entry Entry Min, Max Normally open N/O, normally closed N/C XXXX entry XXXX entry

Parameter Setting

Messages: Default settings and selection range

Note: Function check (HOLD) mode active

Parameter	Default	Selection / Range
Messages <ul style="list-style-type: none"> • pH value • ORP value • rH value • Temperature • mV value 	Limits max Off Off Limits max Off	Off, device limits max., variable limits* Off, device limits max., variable limits* Off, device limits max., variable limits* Off, device limits max., variable limits* Off, device limits max., variable limits* * With "Variable limits" selected, the following parameters can be edited: <ul style="list-style-type: none"> • Failure Limit Lo • Warning Limit Lo • Warning Limit Hi • Failure Limit Hi

Device limits

- Device limits max. Maximum measuring range of device
- Variable limits: Range limits specified

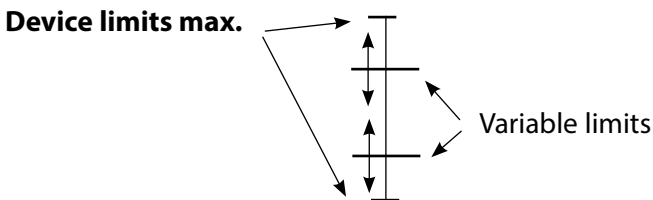





Setting the Message Parameters

Messages

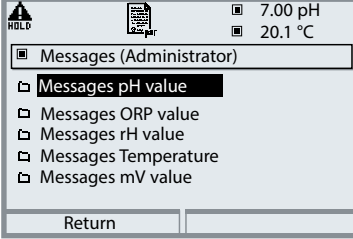
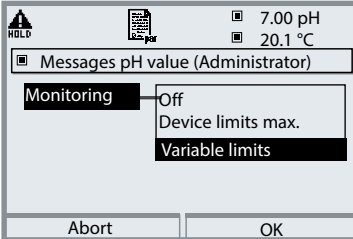
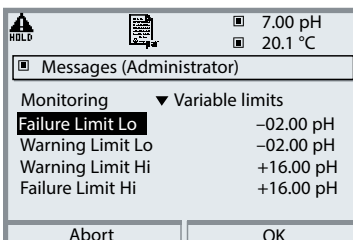
Note: Function check (HOLD) mode active

Note: The display may vary depending on the device version.

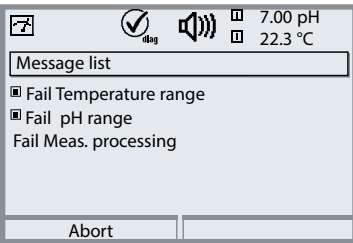
Menu	Display	Messages
	  	<h3>Messages</h3> <p>All parameters determined by the measuring module can generate messages.</p> <ul style="list-style-type: none"> • Device limits max: Messages are generated when the process variable (e.g. pH) is outside the measuring range. The “Failure” icon is displayed, the NAMUR failure contact is activated (BASE module, factory setting: contact K4, N/C contact). The current outputs can signal a 22 mA message (user defined). • Variable limits: For the “failure” and “warning” messages you can define upper and lower limits for message generation. • Message icons: <ul style="list-style-type: none">  Failure (Failure limit HiHi/LoLo)  Maintenance (Warning limit Hi/Lo)
		<h3>Diagnostics menu</h3> <p>When the “Maintenance” or “Failure” icons are flashing in the display, you should call up the Diagnostics menu. The messages are displayed in the “Message list”.</p>

Current Outputs

Select menu: Parameter setting/Module OUT

Note: HOLD mode active

Note: The display may vary depending on the device version.

Menu	Display	Parameter setting Output current
		Configuring the current output <ul style="list-style-type: none"> • Open parameter setting • Enter passcode • Select "Module OUT" • Select "Output current ..."
		<ul style="list-style-type: none"> • Select process variable
		<ul style="list-style-type: none"> • Select Curve, e.g. "linear": The measured variable is represented by a linear output current curve. The desired range of the measured variable is specified by the values for "Start" and "End".

Assignment of Measured Values: Start (4 mA) and End (20 mA)

Example 1: Range pH 0 - 14

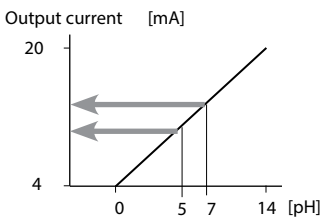

Example 2: Range pH 5 - 7

Advantage: Higher resolution in range of interest

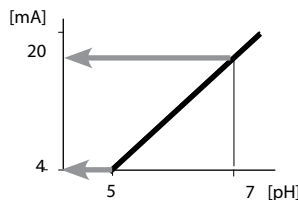

Current Outputs: Characteristics

Select menu: Parameter setting/Module BASE

Note: Function check (HOLD) mode active

- **Linear characteristic**

The process variable is represented by a linear output current curve.

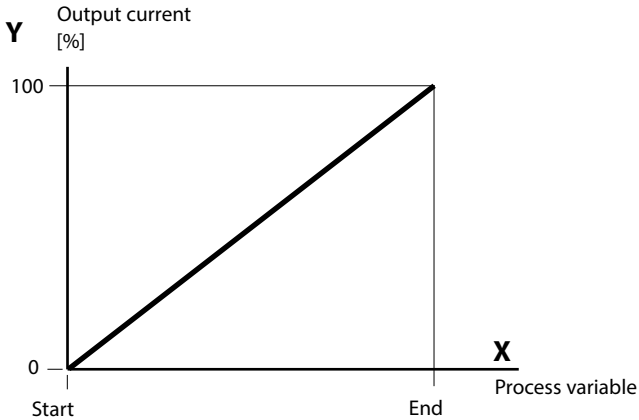

- **Trilinear characteristic**

Two additional vertices must be entered:

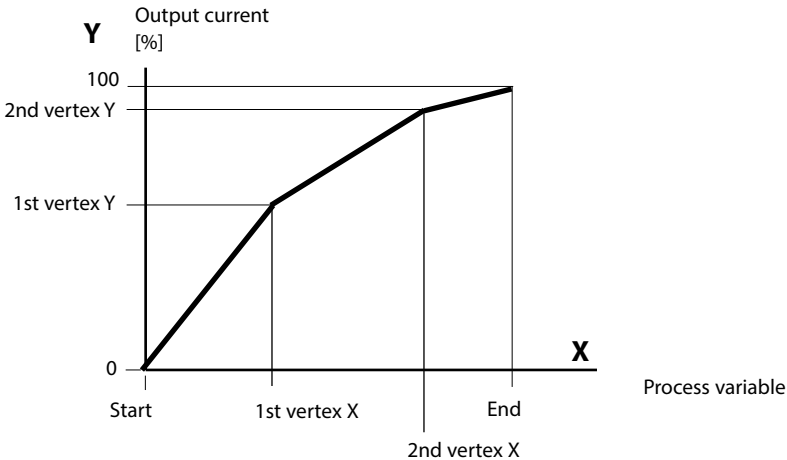

- **Note: Bilinear characteristic**

For a bilinear characteristic, identical parameters are entered for the two vertices (1st vertex, 2nd vertex).

• Function characteristic

Nonlinear output current characteristic: allows measurements over several decades, e.g. measuring very low values with a high resolution and high values with a low resolution.

Required: Entering a value for 50 % output current.

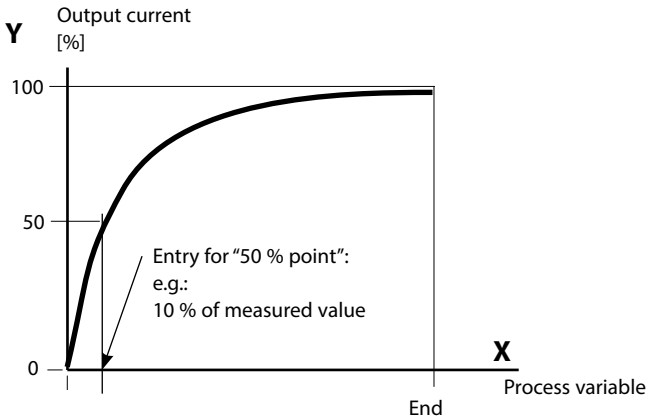

Equation

$$\text{Output current (4 to 20 mA)} = \frac{(1+K)x}{1+Kx} 16 \text{ mA} + 4 \text{ mA}$$

$$K = \frac{E + S - 2 * X50\%}{X50\% - S} \qquad x = \frac{M - S}{E - S}$$

S: Start value at 4 mA

X50%: 50% value at 12 mA (output current range 4 to 20 mA)

E: End value at 20 mA

M: Measured value

Logarithmic output curve over one decade:

S: 10 % of maximum value

X50%: 31.6 % of maximum value

E: Maximum value

Logarithmic output curve over two decades:

S: 1 % of maximum value

X50%: 10 % of maximum value

E: Maximum value

Current Outputs: Output Filter

Select menu: Parameter setting/Module BASE/Output current I.../Output filter

Note: Function check (HOLD) mode active

Time averaging filter

To smoothen the current output, a low-pass filter with adjustable time interval can be switched on. When there is a jump at the input (100 %), the output level is at 63 % after the time interval has been reached.

The time interval can be set from 0 to 120 sec. If the time interval is set to 0 sec, the current output follows the input.

Note:

The filter only acts on the current output and the current value of the secondary display, not on the measurement display, the limit values or the controller!

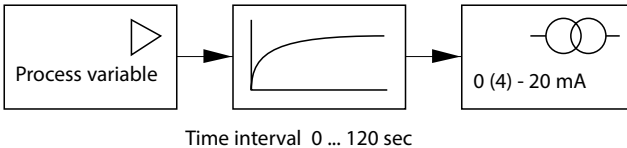

Note:

For further BASE module settings (behavior during messages, contacts, opto-coupler inputs) refer to the user manual of the basic device.

Limit Value, Hysteresis, Contact Type

Parameter setting/Module OUT/Relay contacts/Usage

Note: The display may vary depending on the device version.

Menu	Display	Usage as limit value
		Relay output: Limit <ul style="list-style-type: none"> • Open parameter setting • Enter passcode • Select "Module OUT" • Select "Contact ..." • "Usage: Limit" (Fig.)

Limit value Effective direction min

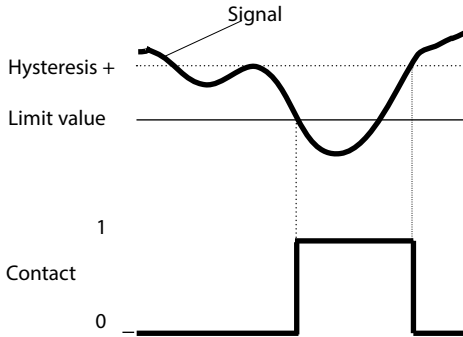

Limit value Effective direction max

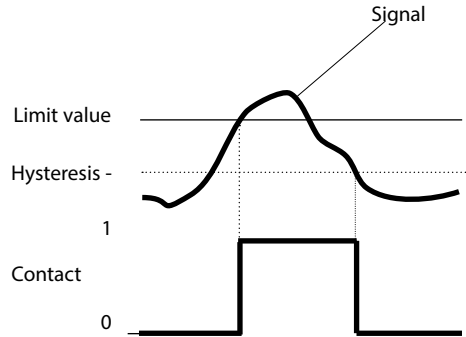

Icons in the Measurement Display

Measured value exceeds limit: Measured value falls below limit:

Hysteresis

Tolerance band around the limit value, within which the contact is not actuated. Serves to obtain appropriate switching behavior at the output and suppress slight fluctuations of the measured variable (Fig.)



Contact Type

Specifies whether the active contact is closed (N/O) or open (N/C).

Maintenance, Diagnostics

Note: During "Maintenance" the function check (HOLD) mode mode is active.

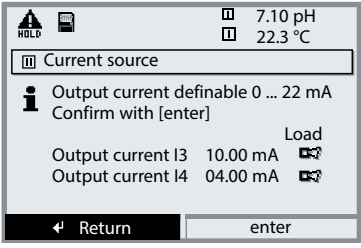
Note: The display may vary depending on the device version.

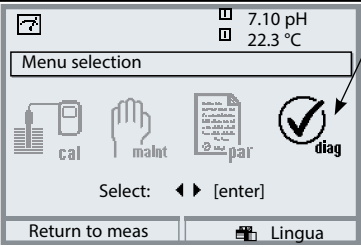
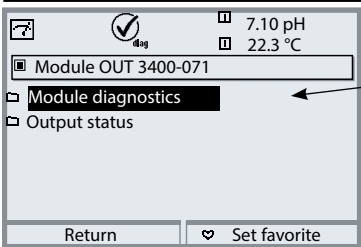
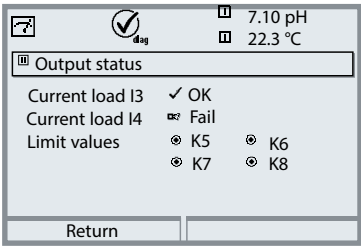

Menu	Display	Maintenance
		<p>Current source (maint. menu) For checking purposes, the output current can be manually specified. The device is in HOLD mode. Select: Maintenance menu/Module OUT 3400-071/Current source.</p>
Menu	Display	Diagnostics
		<p>Open diagnostics From the measuring mode: Press menu key to select menu. Select diagnostics using arrow keys, press enter to confirm. Then select OUT Module.</p>
		<p>The Diagnostics menu gives an overview of all diagnostics functions available. Functions which have been set as "Favorite" can be directly accessed from the measuring mode (see manual for basic unit).</p>
		<p>Diagnostics functions available:</p> <ul style="list-style-type: none"> • Module diagnostics • Function test of internal components. • Output status (Fig.) • Status of signal outputs

Diagnostic Functions

General status information of the measuring system

Select menu: Diagnostics - Message list

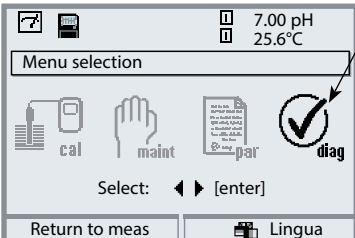
Note: The display may vary depending on the device version.

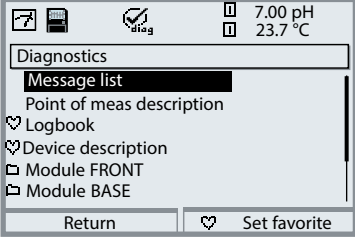
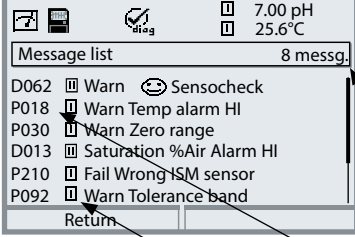
Menu	Display	Diagnostic functions
		<p>Opening the diagnostics menu</p> <p>From the measuring mode: Press menu key to select menu. Select diagnostics using arrow keys, confirm by pressing enter.</p>
		<p>The "Diagnostics" menu gives an overview of all functions available. Functions which have been set as "Favorite" can be directly accessed from the measuring mode.</p>
		<p>Message list</p> <p>Shows the currently activated warning or failure messages in plain text.</p> <p>Number of messages</p> <p>When there are more than 7 messages, a vertical scrollbar appears. Scroll with the up/down arrow keys.</p> <p>Message identifier</p> <p>See message list for description.</p> <p>Module identifier</p> <p>Specifies the module that has generated the message.</p>

Messages

Messages for OUT 3400(X)-071 Module with Protos 3400(X)

No.	OUT messages	Message type
1008	Meas. processing (factory settings)	FAIL
1009	Module failure (Firmware Flash check sum)	FAIL
1070	Current I3 Span	WARN
1071	Current I3 <0/4 mA	WARN
1072	Current I3 > 20 mA	WARN
1073	Current I3 Load error	FAIL
1074	Current I3 Parameter	WARN
1075	Current I4 Span	WARN
1076	Current I4 <0/4 mA	WARN
1077	Current I4 > 20 mA	WARN
1078	Current I4 Load error	FAIL
1079	Current I4 Parameter	WARN
1254	Module reset	Text

Messages

Messages for OUT 3400(X)-071 Module with Protos II 4400(X)

 Failure  Out of Specification  Maintenance Required

No.	Message Type	OUT Messages
I008	Failure	Meas. Processing (Factory Settings)
I009	Failure	Firmware Error
I070	Maintenance Required	Current I3: Span
I071	Maintenance Required	Current I3 < 0/4 mA
I072	Maintenance Required	Current I3 > 20 mA
I073	Failure	Current I3: Load error
I074	Maintenance Required	Current I3: Parameter
I075	Maintenance Required	Current I4: Span
I076	Maintenance Required	Current I4 < 0/4 mA
I077	Maintenance Required	Current I4 > 20 mA
I078	Failure	Current I4: Load error
I079	Maintenance Required	Current I4: Parameter
I100	Info	Current: Manual Control
I254	Info	Module Reset

Specifications

Specifications Protos OUT 3400(X)-071 Module

Current output I3, passive

Supply voltage

Load monitoring

Overrange*

Measurement error**

Start/end of scale*

Current source

0/4 ... 20 mA (22 mA), floating
(electrically connected with output I4)

3 ... 30 V, $I_{\max} = 100 \text{ mA}$, $P_{\max} = 0.8 \text{ W}$

Error message if load is exceeded

22 mA in the case of a message

< 0,25 % current value + 0.05 mA

As desired within range

0.00 ... 22.00 mA

Current output I4, passive

Galvanically connected with output I3, identical data

Limit value outputs

K5 - K8

Voltage drop

Loadability

4 electronic relay outputs, polarized
floating, inter-connected

< 1.2 V

DC: $V_{\max} = 30 \text{ V}$; $I_{\max} = 100 \text{ mA}$; $P_{\max} = 0.8 \text{ W}$

* User-defined

** Rated operating conditions

Specifications

General data

Explosion protection (Ex version of module only)	See certificates or www.knick.de
RoHS conformity	According to EU directive 2011/65/EU
EMC Emitted interference Interference immunity Lightning protection	EN 61326-1, EN 61326-2-3 NAMUR NE 21 Industrial applications* (EN 55011 Group 1 Class A) Industrial applications to EN 61000-4-5, Installation class 2
Rated operating conditions	Ambient temperature: Safe area: -20 ... 55 °C / -4 ... 131 °F Ex: -20 ... 50 °C / -4 ... 122 °F Relative humidity: 10 ... 95 % non-condensing
Transport/storage temperature	-20 ... 70 °C / -4 ... 158 °F
Screw clamp connector	Single or stranded wires up to 2.5 mm ²

* This equipment is not designed for domestic use, and is unable to guarantee adequate protection of the radio reception in such environments.

Overview

Overview of Parameter Setting

Parameter Setting Menu

Note: The menus may vary depending on the device version

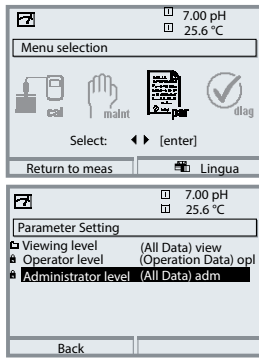

Parameter Setting

From measuring mode: Press **menu** key to select menu. Select parameter setting using arrow keys, press **enter** to confirm.

Administrator level

Access to all functions, also passcode setting. Releasing or blocking functions for access from the Operator level.

Operator level

Access to all functions which have been released at the Administrator level. Blocked functions are displayed in gray and cannot be edited.

Viewing level

Only display, no editing possible!

System Control

Memory card (Option)	Menu only appears when a memory card is inserted and the corresponding add-on function has been enabled.
Transfer configuration	The complete configuration of a device can be written on a memory card. This allows transferring all device settings to other devices with identical equipment (exception: options and passcodes).
Parameter set	2 parameter sets (A, B) are available in the device. The currently active parameter set is shown in the display. Parameter sets contain all settings except: sensor type, options, system control settings Up to 5 parameter sets (1, 2, 3, 4, 5) are available when a memory card (Option) is used.
Function control	Select the functions to be controlled via softkeys and OK inputs
Time/date	Time, date, display format
Meas. point description	Free input of a tag number, can be called from the diagnostics menu
Release of options	Option activation via TAN
Reset to default	Reset all parameters to factory setting
Passcode entry	Change passcodes
Firmware update	Update the firmware using an Update Card
Logbook	Select the events to be recorded

Overview

Overview of Parameter Setting

Parameter Setting Menu



FRONT Module: Display Settings

Language	Select the menu language
Units ¹⁾	Select the measurement units
Formats ¹⁾	Select the display format
Measurement display	Representation of measured values on the display
Display	Brightness/contrast, auto-off

BASE Module: Signal Outputs and Inputs, Contacts

Output current I1, I2	Separately adjustable current outputs
Contact K4	Failure signaling
Contacts K3, K2, K1	Separately adjustable relay contacts
Inputs OK1, OK2	Optocoupler signal inputs

Note: The menu may vary depending on the device version

1) Only with Protos II 4400(X)

Note: The menus may vary depending on the device version

Maintenance Menu



BASE Module

Current source Output current definable 0 ... 22 mA

OUT 3400(X)-071 Module

Current source Output current definable 0 ... 22 mA

Diagnostics Menu



Message list List of all warning and failure messages

Point of meas description

Logbook

Device description Hardware version, Serial no., (Module) Firmware, Options

FRONT Module

Module diagnostics

Display test

Keypad test

BASE Module

Module diagnostics

Input/output status

OUT 3400(X)-071 Module

Module diagnostics

Input/output status

Index

A

- Administrator level 14
- Application in hazardous locations 6
- Attaching the terminal plates 8

B

- Behavior during messages 24
- Bilinear characteristic 22

C

- Configuring the current outputs 21
- Configuring the module 16
- Connecting the module 9
- Contacts, parameter setting 24
- Contact type 25
- Corrective maintenance 6
- Current outputs, characteristics 22
- Current outputs, parameter setting 21
- Current source (maint. menu) 26

D

- Default settings and selection range 17
- Device firmware 7
- Device limits max. 20
- Diagnostic messages 28
- Diagnostics 26
- Disposal 2

E

- Electrostatic discharge (ESD) 9
- EMC 31
- Error messages 28
- Explosion protection, safety instructions 6

Index

F

Firmware version 7

H

Hardware and firmware version 7

Hysteresis 25

I

Installing the module 9

Intended use 5

L

Limit value 25

Limit value, icons in the measurement display 25

Linear characteristic 22

Lock icon 15

Locking a function 15

Logarithmic output curve 23

M

Maintenance 26

Message icons 20

Message list 27

Messages, diagnostics 27

Messages with Protos 3400(X) 28

Messages with Protos II 4400(X) 29

Module compatibility 7

Module firmware 7

Module installation 9

O

Open parameter setting 16

Operating levels 14

Operator level 14

Optocoupler inputs 24

Index

Output filter 24
Overview of parameter setting 32

P

Parameter setting 13
Parameter setting, overview 32

R

Rated operating conditions 31
Release (softkey function) 15
Returns 2

S

Safety Instructions 6
Screw clamp connector 31
Serial number 7
Specifications 30
Start (4 mA) and end (20 mA) 21

T

Table of contents 3
Technical data 30
Terminal plate 8
Trademarks 2
Trilinear characteristic 22

V

Variable limits 20
Viewing level 14

W

Wiring examples 10, 11, 12



Knick
Elektronische Messgeräte
GmbH & Co. KG

Headquarters

Beuckestraße 22 • 14163 Berlin

Germany

Phone: +49 30 80191-0

Fax: +49 30 80191-200

info@knick.de

www.knick.de

Local Contacts

www.knick-international.com

Copyright 2019 • Subject to change

Version: 7

This document was published on September 30, 2019.

The latest documents are available for download on our website below the corresponding product description.

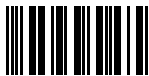

095287

TA-201.071-KNE07

Firmware version: 1.x