

Instruction Manual

703 Laboratory Conductivity Meter



78597

Knick >
Elektronische Meßgeräte
GmbH & Co.
P.O.Box 37 04 15
D-14134 Berlin
Germany

Tel: +49 (0) 30-80191-0
Fax: +49 (0) 30-80191-200
www.knick.de
knick@knick.de



Warranty

Defects occurring within 3 years from delivery date shall be remedied free of charge at our works (carriage and insurance paid by sender).
Accessories: 1 year

Subject to change without notice.

Contents

Information on this instruction manual	II
Safety information	III
1 The 703 Laboratory Conductivity Meter	1
Package contents	1
Short device description	1
2 Operation	3
Meter design	3
General information	4
Power-on and start-up	7
Short instructions	10
Parameter level	15
Calibration level	22
Diagnostics level	26
Recorder output	31
Serial interface	32
Standard settings for ZU 0244 Lab Printer	33
Command set for the serial interface	33
3 Troubleshooting	40
Error messages	40
Maintenance and cleaning	42
Appendix	43
Product line	43
Specifications	44
Calibration solution tables	47
Glossary	49

Information on this instruction manual

Warnings and notes



Instructions marked with this sign must be strictly observed for reasons of your own safety! Failure to follow these instructions may result in injuries



Notes provide important information that should be strictly followed when using the device.

Typical representations

PAR VIEW
ERR --LF--

Display example

A gray representation of the display text indicates a flashing display.



Keys whose functions are described.

Markings in the text

Keys are represented by **bold-faced** text, e.g. **meas**, **print**, **▲**, **▶**, **▼**, , ... , **enter** .

Safety information

Be sure to read and observe the following instructions!

Before connecting the device to the power supply, make sure that the voltage corresponds with the rating given on the rating plate of the device.

Opening the device exposes live parts. Therefore, it shall not be opened. If a repair should be required, return the device to our factory.

If opening the device is inevitable, it shall first be disconnected from all voltage sources.

Make sure that the mains supply has been disconnected. Repair or adjustment of an opened device under voltage shall be carried out only by a skilled person who is aware of the hazards involved.

Remember that the voltage across accessible parts of the open device may be dangerous to life.

Whenever it is likely that the protection has been impaired, the device shall be made inoperative and secured against unintended operation.

The protection is likely to be impaired if, for example:

- the device shows visible damage
- the device fails to perform the intended measurements
- after prolonged storage at temperatures above 70°C
- after severe transport stresses

Before recommissioning the device, a professional routine test in accordance with EN 61010-1 must be performed. This test should be carried out at our factory.

**EG-Konformitätserklärung
EC Declaration of Conformity
Déclaration de Conformité CE**Dokument-Nr. / Document No. /
No. document**EG90723A**Aufbewahrung / Keeping / Garde en dépôt
Jürgen Cammin (KB)

Wir, die / We, / Nous,

**Knick Elektronische Messgeräte GmbH & Co. KG
Beuckestr. 22, D-14163 Berlin**erklären in alleiniger Verantwortung, daß dieses Produkt / diese Produkte,
declare under our sole responsibility that the product / products,
déclarons sous notre seule responsabilité que le produit / les produits,Produktbezeichnung /
Product identification /
Désignation du produit**Labor-Konduktometer 703, Opt. ...**auf welche(s) sich diese Erklärung bezieht, mit allen wesentlichen Anforderungen der folgenden Richtlinien des Rates übereinstimmen:
to which this declaration relates is/are in conformity with all essential requirements of the Council Directives relating to:
auquel/auxquels se réfère cette déclaration est/sont conforme(s) aux exigences essentielles de la Directives du Conseil relatives à:Niederspannungs-Richtlinie /
Low-voltage directive /
Directive basse tension**2006/95/EG**Jahr der Anbringung der CE-Kennzeichnung / **1995**
Year in which the CE marking was affixed /
L'année d'apposition du marquage CEHarmonisierte Normen / Harmonised
Standards / Normes harmonisées**EN 61010-1: 2001**EMV-Richtlinie / EMC directive /
Directive CEM**2004/108/EG**

Norm / Standard / Norme

**EN 61326-1: 2006
EN 61326-2-3: 2006**Ausstellungsort, -datum /
Place and date of issue /
Lieu et date d'émission**Berlin, 23.07.2009****Knick Elektronische Messgeräte GmbH & Co. KG**
Wolfgang Feucht
(Geschäftsführer / C.T.O.)
ppa.
Bernhard Kusig
(Vice President Marketing/Sales)

1 The 703 Laboratory Conductivity Meter

Package contents

After unpacking, please check the shipment for completeness.

The package should contain:

- 703 Laboratory Conductivity Meter
- Power cord
- This instruction manual

Short device description

- The 703 Laboratory Conductivity Meter is used for electrolytic conductivity measurement in the lab.
- The meter can be operated with either 2-electrode or 4-electrode sensors. In conjunction with the Knick ZU 6985 4-electrode sensor, the meter functions reliably over a wide conductivity range from $< 1.00 \mu\text{S}/\text{cm}$ to $> 1000 \text{ mS}/\text{cm}$.
- For temperature-compensated conductivity measurement, e.g. for determining concentrations, a temperature coefficient can be specified.
- Temperature compensation takes place automatically with a Pt 1000- oder NTC 30 k Ω temperature probe or manually by presetting the temperature.
- Unknown cell constants can easily be determined with a standard calibration solution. The meter automatically takes the TC of the calibration solution into consideration, calculates the cell constant and displays it. Of course, the cell constant can also be entered directly.
- The GLP timer alerts you when the preset interval between two device self-tests has expired.

- The Sensoface[®] sensor monitoring function monitors the conductivity sensor and measuring equipment and provides information on sensor selection and handling.
It reports clock memory loss and requests regular checks in accordance with GLP.
Knick Fullcheck[®] device self-test checks the device functions at the press of a key.
- Records of parameter setting, calibration and diagnostics are particularly helpful for QM documentation to ISO 9000 and GLP.

The records can be output via the integrated interface directly to the ZU 0244 Lab Printer or to any other commercially available printer with serial port.

2 Operation

Meter design

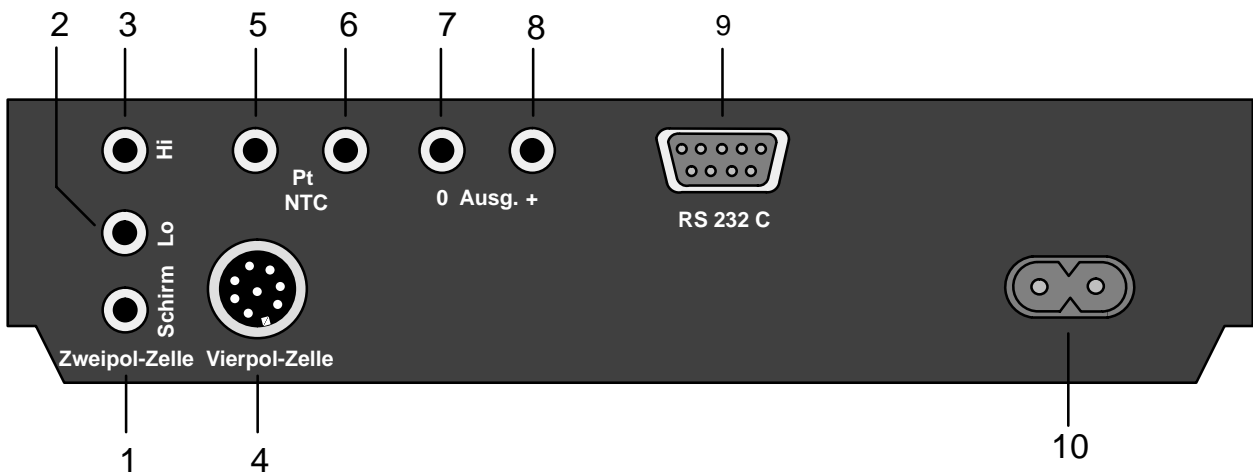
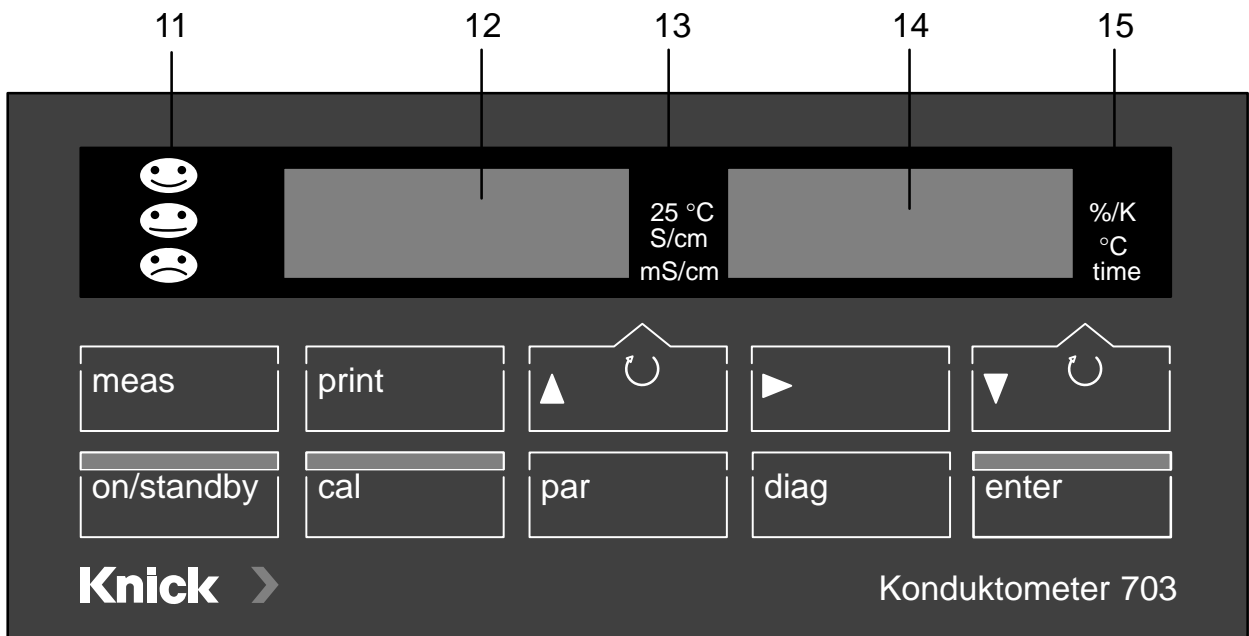

- 1, 2, 3 Connection for two-electrode sensor
- 4 Connection for four-electrode sensor (ZU 6985)
- 5, 6 Temperature probe connection
- 7, 8 Recorder output
- 9 Interface connection
- 10 Power input
- 11 Sensoface[®] display
- 12, 14 Displays
- 13, 15 Measurement symbols

General information

Keypad



Pressing **on/standby** turns the meter on or switches to standby mode. Standby mode is indicated by a lighted Sensoface[®] status indicator or two measurement symbols. At power-on, the meter automatically performs a short self test and then goes to measuring mode.



Pressing **cal** opens the Calibration level. During calibration the meter is adapted to the conductivity sensor. You can either perform an automatic calibration or manually enter the cell constant.

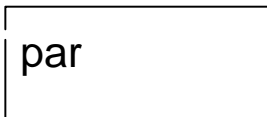

Pressing **par** opens the Parameter level. On the Parameter level all variable device parameters are set.

- In the *VIEW* menu you can view all parameters.
- In the *EDIT* menu you can also edit the parameters.

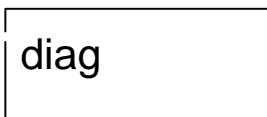

Pressing **diag** opens the Diagnostics level. The Diagnostic level provides information on the conductivity sensor and measuring equipment. In addition, you can perform a complete device self-test.

- In the Sensoface[®] menu the Sensoface[®] parameters of the sensor and measuring equipment are listed separately with the respective validation.
- With the Knick Fullcheck[®] menu, a complete device self-test is performed.

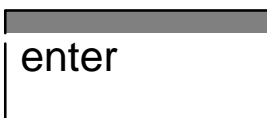

Pressing **enter** stores an entered parameter. If you have not made any changes, pressing **enter** selects the next parameter (instead of ▼).

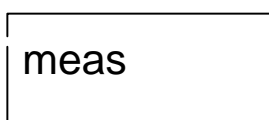

Pressing **meas** exits a function level and returns you to measuring mode.



Pressing **print** in measuring mode prints out the currently measured values for conductivity and temperature with date and time.

Pressing **print** on one of the function levels prints out a complete record of the data stored.

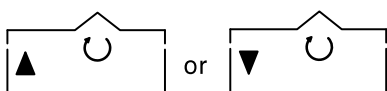

- If manual range selection has been set (see Pg. 19), select the conductivity range in the measuring mode with ▲ .

- With ▼ you can choose either temperature or time in the right-hand display. The corresponding measurement symbol appears on the right side of the display.

- On the function levels these keys are used to select parameters.

- When entering numerical parameters, they are used to increment or decrement a numeral.

- Pressing ► in the *EDIT* menu of the Parameter level selects the parameter you want to edit.

- In the *VIEW* menu and on the Diagnostics level the automatic line advance is stopped with this key.



Menu structure

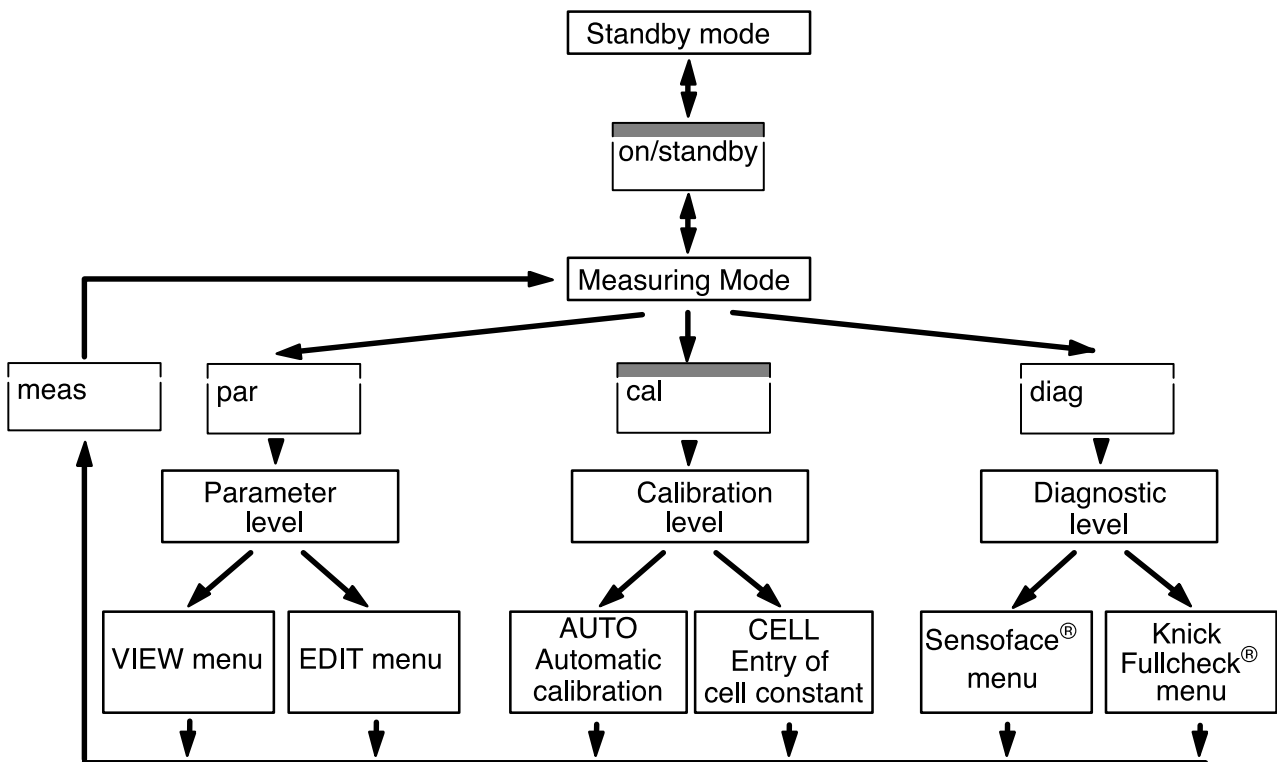

Sensoface® automatic monitoring function

Sensoface® monitors the conductivity sensor and measuring equipment and provides information on sensor selection and handling. It reports clock memory loss and requests regular checks in accordance with GLP.

A summary of the individual results is expressed by three face symbols.

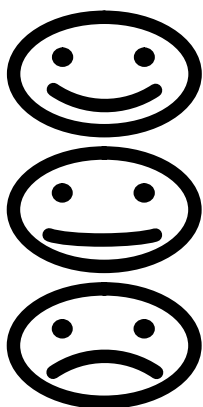

- ☺ Sensor and equipment are in good condition and are operating in a reliable range.
- ☹ Sensor and equipment are still in usable condition. However, to prevent larger measurement errors, they should be checked.
- ☹ Sensor and equipment are in poor condition or are being operated in the wrong range. A check is absolutely necessary.

For more detailed information on the indicated Sensoface® parameters, please refer to the "Diagnostics level" chapter (see Pg. 26).

Power-on and start-up

Mains supply

The meter is designed for a 230 V AC power supply (Option 363: 115 V AC).

Connect the power input of the meter to a mains outlet using the included power cord.

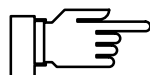

If the meter is disconnected from mains, clock and GLP timer are not affected (reserve power approx. 1 year). Settings, calibration and diagnostics data remain permanently stored.

Sensor connection

In addition to the Knick ZU 6985 4-electrode sensor with integrated temperature probe, you can also connect commercially available 2-electrode sensors.

Connection	Socket
2-electrode sensor	1, 2, 3
ZU 6985 4-electrode sensor	4
Temp probe (Pt 1000 or NTC 30 kΩ)	5, 6

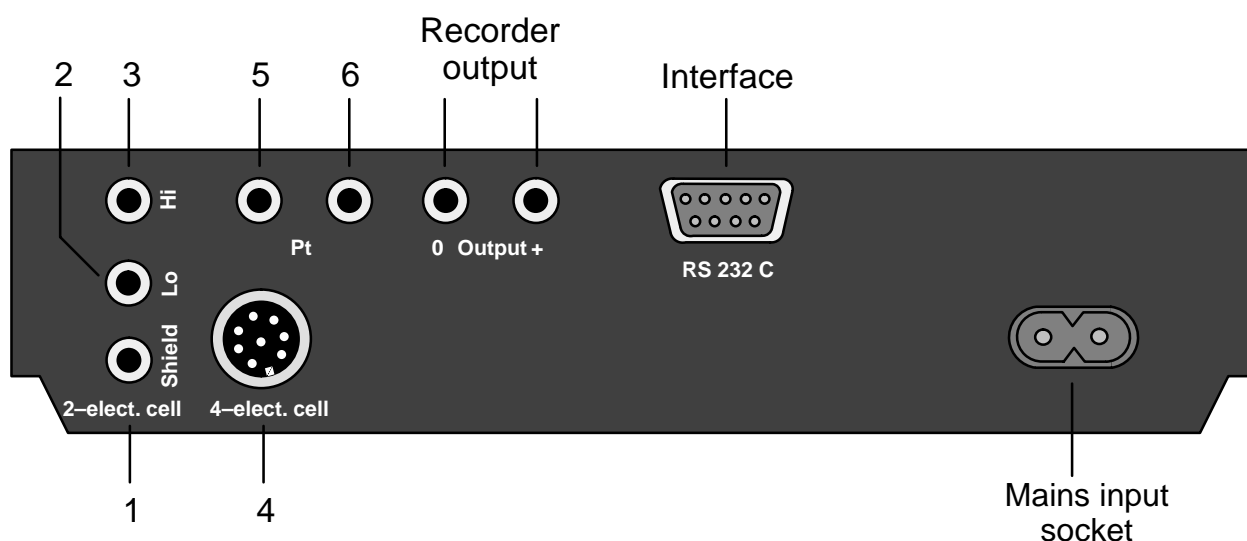

If no temperature probe is connected, the meter uses the manually selected temperature. The decimal point of the temperature display flashes.

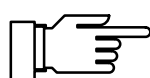

For the RS 232 interface, a shielded cable must be used (e.g. ZU 0245, ZU 0152).

Standby mode

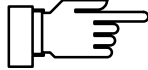

If the meter is connected to a mains outlet but not switched on, it is in standby mode. This is indicated by a lighted Sensoface[®] display. If Sensoface[®] display is turned off, two measurement symbols are lighting.

Clock and calibration timer are running in standby mode. Settings, calibration and diagnostics data remain permanently stored. The interface is deactivated.

Pressing **on/standby** switches the meter to measuring mode.

At power-on, the meter performs a short check:

Simultaneous lighting-up of all display segments, measurement symbols and Sensoface[®] displays

- Memory test
- Display of model name *LF 703*

To stop the short check, press **meas**.

Measuring mode

In the measuring mode the left-hand display always indicates the conductivity value. If the automatic range selection has been set (see Pg. 19), the meter automatically searches for the optimum measurement range. The measurement symbol automatically switches between $\mu\text{S}/\text{cm}$ and mS/cm . With manual range selection, select the desired range with **▲**.

Left-hand display:

- Conductivity value [$\mu\text{S}/\text{cm}$ or mS/cm]

In the right-hand display either the temperature or time is selected with **▼**.

If automatic temperature compensation has been selected (see Pg. 18), the right-hand display always shows the selected temperature coefficient. Pressing **▼** briefly switches to temperature or time. The display $20\text{ }^{\circ}\text{C}$ or $25\text{ }^{\circ}\text{C}$ indicates to which reference temperature the conductivity is converted.

Right-hand display:

- Temperature [°C]
- Time
- Temperature coefficient [%/K]

A flashing point on the temperature display indicates that no temperature probe is connected. The meter now uses the manually selected temperature.

print

If you have connected a printer, pressing **print** in the measuring mode gives you a printout of the currently measured values with date and time.

Short instructions

Measuring with the Knick 4-electrode sensor ZU 6985



Connect the ZU 69855 4-electrode sensor to socket 4 and switch on the meter.
The automatic short check runs.



The ZU 6985 4-electrode sensor is equipped with an integrated temperature probe. Therefore, manual temperature specification is not possible. No additional temperature probe may be connected to sockets 5 and 6.



CELL 1.160

Press **cal** to open the Calibration level.
Press **enter** to confirm *CAL CELL*.

Read the cell constant off the rating plate on the sensor cable, enter this value on the meter using **▲** and **▼**, and confirm with **enter**.
The meter now automatically ends the calibration and returns to measuring mode.

To measure, now immerse the sensor into the measuring solution so that the liquid surface is always between the two markings of the protective tube of the sensor. An incorrect immersion depth leads to incorrect measurements!

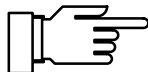

Always rinse the sensor thoroughly between two measurements. Carrying over the solution can cause considerable measurement errors, particularly at low conductivities. Either distilled water can be used as a rinsing liquid, or the sensor should be pre-rinsed with measuring solution.
Also make sure that the measuring solution is completely mixed prior to measurement. Repeated immersion and removal of the sensor promotes mixing.

Measuring with a 2-electrode sensor with external temp probe



Connect the 2-electrode sensor to the sockets 2 and 3. If there is a shielding, connect it to socket 3. Connect the external temperature probe to sockets 5 and 6. Switch on the meter. The automatic short check runs.

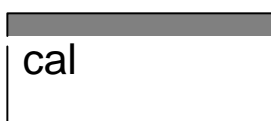

Press **cal** to open the Calibration level. Press **enter** to confirm *CAL CELL*.



Enter the cell constant of the conductivity sensor using ▲ and ▼ and confirm your entry with **enter**. The meter now automatically ends the calibration and returns to measuring mode.

Now you can begin your measurements. Please observe the instructions of the sensor manufacturer.



Always rinse the sensor thoroughly between two measurements. Carrying over the solution can cause considerable measurement errors, particularly at low conductivities. Either distilled water can be used as a rinsing liquid, or the sensor should be pre-rinsed with measuring solution.

Also make sure that the measuring solution is completely mixed prior to measurement. Repeated immersion and removal of the sensor promotes mixing.

Determining an unknown cell constant

on/standby

Connect the conductivity sensor and, if required, the temperature probe as described in the instructions and switch on the meter. The automatic short check runs.

par

Press **par** to access the Parameter level. Select *PAR EDIT* using ▲ or ▼ and confirm with **enter**.

SOL NA CL

Select the calibration solution setting *SOL* using ▼. Either NaCl or KCl solutions in various concentrations can be used as calibration solutions. Select the desired solution using ► and ▲ or ▼ and confirm with **enter**.

NA CL 0.01M

In the next calibration step select the concentration of the calibration solution to be used. Select the desired concentration using ► and ▲ or ▼ and confirm with **enter**.

meas

Press **meas** to exit the Parameter level.

cal

Press **cal** to open the Calibration level. Select *CAL AUTO* using ▲ or ▼ and confirm with **enter**.

CAL YES

Immerse the conductivity sensor and temperature probe in the calibration solution and press **enter** to start the calibration.



Make sure that the calibration used corresponds to the presetting. The use of a different calibration solution leads to an incorrect cell constant and thus produces incorrect measured values.

The calibration now runs automatically. The determined cell constant is briefly displayed and the meter returns to measuring mode.

Measuring without temperature probe

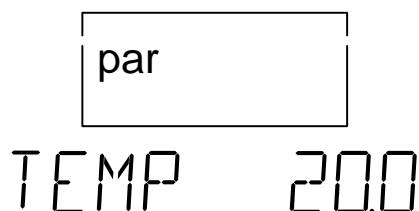

If no temperature probe is connected, the meter uses the manually selected temperature. In this case, the decimal point of the temperature display will flash in measuring mode.

Press **par** to access the Parameter level. Select *PAR EDIT* using ▲ or ▼ and confirm with **enter**.

As the first parameter-setting step the entry of the manual temperature appears. Enter the temperature of the measuring or calibration solution with ► and ▲ or ▼ and confirm with **enter**.



Press **meas** to exit the Parameter level.



Make sure that the manually specified temperature and the temperature of the measuring or calibration solution match. Temperature differences lead to measurement errors!

Measuring with automatic temperature compensation



The electrolytic conductivity is highly dependent on the temperature. For comparative measurements, the actual conductivity (at measuring temperature) is often of no interest, but rather the conductivity the solution would have at a reference temperature (e.g. 25 °C). Therefore, with the temperature compensation switched on, the measured conductivity is converted to a conductivity at the reference temperature using a solution-specific temperature coefficient.

As a result, a largely temperature-independent display value is obtained.

Press **par** to access the Parameter level. Select *PAR EDIT* using ▲ or ▼ and confirm with **enter**.

TC OFF

Select the temperature compensation TC using ▼. Switch on using ► and ▲ or ▼. Confirm your entry with **enter**.

TC 02.50^{%/K}

In the next step enter the temperature coefficient of the solution to be measured using ►, ▲ and ▼ and confirm with **enter**.

TREF 25°C

Then enter the reference temperature using ►, ▲ and ▼. You can select either 20 °C or 25 °C. Confirm your entry with **enter**.

meas

Press **meas** to exit the Parameter level.

The conductivity based on the reference temperature is now displayed together with the entered temperature coefficient.



To simplify calculation, the TC of a solution is assumed to be linear during automatic temperature compensation. However, in practice the TC itself is temperature-dependent and thus non-linear. Therefore, to prevent larger errors, the reference and measuring temperature should not differ too greatly during automatic temperature compensation. Sensoface[®] also draws your attention to this fact (see Pg. 27).

Parameter level



Activating parameter setting

Main menu

PAR VIEW

PAR EDIT

On the Parameter level all variable device parameters are set. Parameters are set in dialog mode using different menus.

Press **par** to exit measuring mode and access the main menu of the Parameter level. To exit Parameter level, press **meas**. It is exited automatically when all parameter setting steps have run through.

In the main menu of the Parameter level you select the desired submenu. In the main menu of the Parameter level you select the desired submenu using ▲ or ▼. Pressing **enter** confirms your choice and gives access to the corresponding submenu.

The *VIEW* menu automatically displays all parameters. Settings cannot be changed, however.

- To stop the display, press ►.
- To scroll one line forwards or backwards, press ▲ or ▼, respectively.

In the *EDIT* menu you can view and edit all parameters.

- Select the parameter you want to edit using ▲ or ▼.
- Press ► to start parameter editing. To indicate that the parameter can now be edited, the right display flashes.
- While the right display is flashing, you can edit the parameter using ▲ and ▼. When entering numerical values, select the position using ► and then count up or down using ▲ or ▼.
- Confirm your entry with **enter**. The selected value will be stored and the next parameter displayed.
- You can now select the next parameter using ▲ or ▼ or press **meas** to exit the Parameter level.

Typical setting procedure

37.88 $\mu\text{S}/\text{cm}$ 25.0 $^{\circ}\text{C}$



PAR VIEW

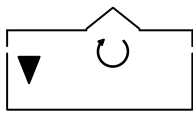

PAR EDIT

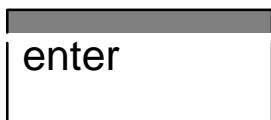

TEMP 20.0

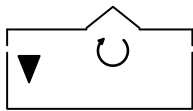

RNGE AUTO

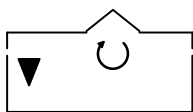

RNGE AUTO

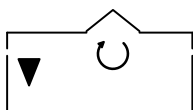

RNGE FIX

The meter is factory-set for automatic range selection. However, you want to select the range manually.

Press **par** to access the Parameter level.

Press **▼** to select the *EDIT* menu.

Press **enter** to confirm and open the *EDIT* menu.

Select range selection *RNGE* using **▼**.

Now press **▶** to change the range setting. The right display will flash.

Press **▼** to select *FIX* for manual range selection.

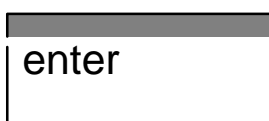

enter

Confirm your entry with **enter** . The next parameter will be displayed.

SOL NA CL



meas

Press **meas** to exit Parameter level.

Printout of parameter record



par

If you have connected the pH meter to a printer, you can print out all stored parameter settings.

Press **par** to open the Parameter level.
Press **print** to print out all settings.



print

The meter will automatically return to measuring mode.

Parameters

In the following, the individual parameters and their possible settings will be explained.

TEMP 20.0

Manual temperature (50 to +150 °C)

If no temperature probe is connected, the meter uses the manually selected temperature. In this case, the decimal point of the temperature display will flash in measuring mode.

TC OFF

Temperature compensation (off/on)

The electrolytic conductivity is highly dependent on the temperature. For comparative measurements, the actual conductivity (at measuring temperature) is often of no interest, but rather the conductivity the solution would have at a reference temperature (e.g. 25 °C). Therefore, with the temperature compensation switched on, the measured conductivity is converted to a conductivity at the reference temperature using a solution-specific temperature coefficient. As a result, a largely temperature-independent display value is obtained.

TC 02.50 %/K

Temperature coefficient (0.00 to +9.99 %/K)

The temperature coefficient specifies the degree of temperature dependency of the conductivity in % per Kelvin.

The temperature coefficient of your solution can be calculated with the following equation:

$$T_c = \frac{\chi_T - \chi_{Ref}}{\chi_{Ref} \times (T - T_{Ref})} \times 100 \quad (\%/K)$$

T_c = Temperature coefficient

χ_T = Conductivity at measuring temperature

χ_{Ref} = Conductivity at reference temperature

T = Measuring temperature

T_{Ref} = Reference temperature

TREF 25°C

Reference temperature (20 °C/25 °C)

The reference temperature is the temperature to which the display value is to be converted.

Either 20 °C or 25 °C can be selected.

FACE ON

Sensoface® (off/on)

The Sensoface® display can be turned on or off. If Sensoface® display is turned off, standby mode is indicated by two lighted measurement symbols. Display of Sensoface® parameters on the Diagnostics level is not affected. For information on Sensoface®, refer to chapter "Sensoface® menu" (see Pg. 26).

RNGE AUTO

Range selection (auto/fix)

With *AUTO* the meter automatically searches the optimum measurement range. With *FIX* the automatic range selection is switched off. Then you select the desired range in the measuring mode using ▲. If the selected range is exceeded, *OVFL* appears in the left-hand display.

SOL NA CL

Calibration solution (NaCl/KCl)

Either NaCl or KCl solutions in various concentrations can be used as calibration solutions. Select the desired solution.

NA CL 0.01 M

Concentration of solution (SAT/0.1 M/0.01 M)

NaCl solutions are available in the following concentrations:

0.01 mol/l
0.1 mol/l
Saturated

K CL 0.01 M

(1.0 M/0.1 M/0.01 M)

Select the concentration of the calibration solution to be used.

KCl solutions are available in the following concentrations:

0.01 mol/l
0.1 mol/l
1 mol/l

GLPT 0 168

GLP timer (0 to 2000 h)

With the GLP timer, you can preset a time interval for the next due device self-test.

After approx. 80 % of the preset interval have expired, the GLP timer sets the Sensoface® display from 😊 to 😊. After the total interval has expired, the display is set to ☹.

OUT 20 μ S

The timer is reset by a device self-test or by entering a new GLP interval.

To turn off the GLP timer, enter 0 as interval time.

Recorder output
(20 μ S/2.0 mS/20 mS/2.0 S/ $^{\circ}$ C/PRNT)

The recorder output can output either the conductivity value or the temperature.

Output voltage:

- OUT 20 μ S 100 mV/(μ S/cm)
- OUT 2.0 μ S 1 mV/(μ S/cm)
- OUT 20 μ S 100 mV/(μ S/cm)
- OUT 2.0 μ S 1 mV/(μ S/cm)
- OUT $^{\circ}$ C 10 mV/ $^{\circ}$ C

With PRNT selected, the recorder output serves as input for activating a print command. With a simple contact, such as a foot switch, the currently measured values can be printed. For further information, refer to the chapter "Recorder output" (see Pg. 31).



Do not apply an external voltage to the recorder output. The meter might be damaged.

BAUD 4800

Baud rate (600 / 1200 / 2400 / 4800 / 9600)
Here, you can select the interface transmission rate.

DATA 7 EV

Data format (8 NO / 7 EV / 7 OD)

You can choose between:

Data word length	Parity
8 bits	none
7 bits	even
7 bits	odd

PRTC NO

Transmission protocol (NO / XON)

The interface can operate either without transmission protocol or with XON/XOFF protocol.

INTF PRNT

Interface (PRNT / PC)

For direct printer control, select PRNT. You can directly print out measured values and records.

To connect the meter to a computer (PC), select PC. The conductivity meter will be completely computer controllable. All measured values and parameters will be retrievable via computer.

PTIM 060.0

Print interval timer (0.1 to 999.9 min)

This step only appears if you have set the interface for printer control.

The print interval timer presets an interval for print-out of currently measured values with time and date.

To turn off the timer, enter 0 as interval time.

TIME 08.16

Time

DATE 19.11

Date

YEAR 1999

Year

END VIEW

End of *VIEW* menu.

END EDIT

End of *EDIT* menu.

Calibration level

On the Calibration level you enter the cell constant of the conductivity sensor used.

If the cell constant is unknown or the indicated cell constant is too inexact, it can also be determined using a calibration solution.

Activating calibration

Press **cal** to exit measuring mode and access the Calibration level.

You can stop calibration at any time by pressing **meas**.

Main menu

In the main menu of the Calibration level you select the desired submenu using ▲ or ▼. Pressing **enter** confirms your choice and gives access to the corresponding submenu.

CAL CELL

Manual calibration with input of cell constant is used when the cell constant of the conductivity sensor used is known or when you use a calibration solution that is not stored in the meter.

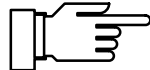

For the Knick ZU 6985 4-electrode sensor, the cell constant is printed on the rating plate at the sensor cable.

CAL AUTO

With automatic calibration the cell constant is determined using the standard calibration solutions stored in the meter.

Manual calibration by input of cell constant

When the cell constant of the conductivity sensor used is known, it can be directly entered. When using a calibration solution, the conductivity value is adjusted by modifying the cell constant.

CAL CELL

87.32 mS/cm 1.160

Press **enter** to confirm *CAL CELL*.

The left display shows the measured uncompensated conductivity and the right display shows the cell constant.

Input of cell constant:

When the cell constant is known, enter its value using ▲ or ▼. The cell constant may lie between 0.001 cm^{-1} and 199.9 cm^{-1} .

Using a calibration solution:

Measure the temperature of the calibration solution (e.g. with a glass thermometer) and read the temperature-corrected conductivity value from the calibration solution table. Modify the cell constant using ▲ or ▼ until the measured conductivity shown in the left display is identical with the conductivity previously taken from the calibration solution table.

Confirm your entry with **enter**.

Automatic calibration

With automatic calibration the cell constant is determined using a standard calibration solution. The following calibration solutions are available:

KCl	0.01 mol/l
	0.1 mol/l
	1 mol/l
NaCl	0.01 mol/l
	0.1 mol/l
	Saturated

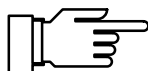

The calibration solution is selected on the Parameter level (see Pg. 15, 19).

CAL AUTO

Press **enter** to confirm *CAL AUTO*.

CAL YES

Immerse the conductivity sensor and temperature probe in the calibration solution and press **enter** to start the calibration.

If you do not want to calibrate, select *CAL NO* using ▼ or ▲ and press **enter** to exit Calibration level.

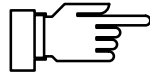

Make sure that the calibration used corresponds to the presetting. The use of a different calibration solution leads to an incorrect cell constant and thus produces incorrect measured values.



When working with manual temperature compensation, make sure that the entered temperature matches the actual temperature of the calibration solution! An incorrectly set temperature leads to an incorrect calculation of the cell constant and thus to measurement errors.

CAL 20.0°C

During a first plausibility check of conductivity and temperature, *CAL* flashes. The right-hand display shows the measured temperature.

When working with manual temperature compensation, the entered temperature is displayed. This is indicated by a flashing decimal point.

NA₂CO₃ SAT

As a check, the selected calibration solution is displayed for approx. 4 sec and $\mu\text{S/cm}$ or mS/cm flashes.

225.0 mS/cm 0" time

The stability of the measured conductivity and temperature values is checked. During this, the conductivity determined from the calibration table is indicated in the left-hand display. A small clock runs in the right-hand display. For each revolution (4 sec), a mark is added to the tally beside the clock.

CELL 1.160

Display of calculated cell constant.

END CAL

End of calibration



Always rinse the sensor thoroughly after a calibration and between two measurements. Carrying over the solution can cause considerable measurement errors, particularly at low conductivities. Either distilled water can be used as a rinsing liquid, or the cell should be pre-rinsed with measuring solution.

Printing calibration record

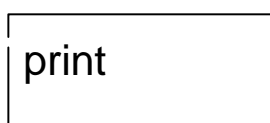
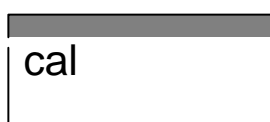

If you have connected the meter to a printer, you can print out a record of the last calibration.

Press **cal** to open the Calibration level. Press **print** to print out the complete record of the last calibration.

The meter will automatically return to measuring mode.

Diagnostics level



On the Diagnostics level the complete conductivity measurement equipment is checked. This also serves for quality management to ISO 9000.

Activating diagnostics

Press **diag** to exit measuring mode and access the main menu of the Diagnostics level. To exit Diagnostics level, press **meas**. It is exited automatically when all diagnostics functions have been performed.

Main menu

In the main menu you select the desired function of the Diagnostics level using ▲ or ▼. Pressing **enter** gives access to the corresponding sub-menu.

DIAG FACE

The Sensoface[®] menu shows the states of the criteria that control Sensoface[®] display.

DIAG TEST

The Knick Fullcheck[®] menu provides a complete device self test to check the operability of the individual device components.

All submenus run automatically but can be influenced via keypad.

- To stop the sequence, press ►. To restart it, press ► once more.
- To scroll one step forwards or backwards, press ▲ or ▼, respectively.

Sensoface[®] menu

In the Sensoface[®] menu you see the criteria that control Sensoface[®] display. Each criterion is displayed separately with the corresponding evaluation.

DIAG FACE









This gives you important information on sensor selection and handling and Sensoface[®] alerts you for possible errors.

CELL RNGE

If a 2-electrode sensor is operated in an incorrect conductivity range, measurement errors can occur due to polarization of the sensor.



Sensoface[®] informs you when the current conductivity range can no longer be reliably measured with the sensor being used.

Ranges:

Cell const. [cm ⁻¹]					
0.001	> 20 μS	> 10 μS			
0.01	> 200 μS	> 100 μS			
0.1	> 2 mS	> 1 mS			
					
1	> 20 mS	> 10 mS		< 0.2 μS	< 0.1 μS
10	> 200 mS	> 100 mS		< 2 μS	< 1 μS
100	> 2 S	> 1 S		< 20 μS	< 10 μS

TC TEMP



To simplify calculation, the TC of a solution is assumed to be linear during automatic temperature compensation. However, in practice the TC itself is temperature-dependent and thus non-linear. Therefore, to prevent larger errors, the reference and measuring temperature should not differ too greatly during automatic temperature compensation. Sensoface[®] draws your attention to excessive differences between reference and measuring temperature.

-  The difference between reference and measuring temperature is ≤ 20 K.
-  The difference between reference and measuring temperature is > 20 K.

GLP TIME

On the Parameter level, the GLP timer allows to preset a time interval for the next due device self-test.

The GLP timer keeps running in standby mode and with mains supply disconnected.

-  The interval is still running.
-  Over 80% of the interval have already expired.
-  The interval has been exceeded.

ACCU CHECK

If the battery voltage is too low, the operation of the clock and the GLP timer is no longer ensured.



Battery voltage okay



Battery voltage still sufficient



Battery voltage too low

DATE CHECK

Extreme interferences or insufficient battery voltage may set back the clock. Sensoface® indicates when the clock must be set.



Clock must be set.

END FACE

End of Sensoface® menu.

Knick Fullcheck® menu

DIAG TEST

With the Knick Fullcheck® menu, a complete device self-test is performed. The complete measuring circuitry, measured value processing, memories, display and keypad are checked and each result is displayed.

The tests run automatically. Only during keypad testing you have to press the requested keys.

Longer testing periods are indicated by a little running clock on the right display.

--OK--

Successful testing is confirmed by *OK* on the right display.

RAM -----

RAM test

PROM 0

EPROM test

EEPROM -----

EEPROM test

OUT TEST

Linearity test of measuring circuit: Using an integrated, high-precision reference, the complete measuring circuitry is checked up to the recorder output. The displayed mV values lie across the recorder output.

- 500 0

Linearity test at -500 mV

0 0

Linearity test at 0 mV

750 0

Linearity test at +750 mV

1500 0

Linearity test at +1500 mV

AMPL TEST

To test the input amplifier, the conductivity sensor is disconnected internally from the amplifier and the input is switched over to a reference resistor.

RNG 1 0

Amplifier test for conductivity range 1

RNG 2 0

Amplifier test for conductivity range 2

RNG 3 0

Amplifier test for conductivity range 3

ACCU -----

Test of memory battery.

DISPL TEST

Display test: All Sensoface® indicators, all segments of the two LED displays and all measurement symbols light up.

 20 °C
 25 °C
 μS/cm
 mS/cm
 %/K
 °C
 time

Check whether really everything is lighting.

KEY TEST

During keypad testing, you are prompted to press the corresponding key.

PUSH MEAS
PUSH PRNT
PUSH UP
PUSH CURS
PUSH DOWN
PUSH ON
PUSH CAL
PUSH PAR
PUSH DIAG
PUSH ENTR
END TEST

Press **meas**.

Press **print**.

Press ▲.

Press ►.

Press ▼.

Press **on/standby**.

Press **cal**.

Press **par**.

Press **diag**.

Press **enter**.

End of device test

Printing diagnostics record

If you have connected the meter to a printer, you can print out a record of the diagnostics.

diag

print

Press **diag** to open the Diagnostics level. Press **print** to print out the complete diagnostics record.

Recorder output

The recorder output of the Model 703 supplies an analog output signal. Galvanic output isolation is standard. Connected recorders and data acquisition systems thus do not have to be floating.

The output can be defined on the Parameter level for four different conductivity ranges or for temperature:

Input range	Output voltage
0 to 20 $\mu\text{S/cm}$	100 mV/($\mu\text{S/cm}$)
0 to 2 mS/cm	1 mV/($\mu\text{S/cm}$)
0 to 20 mS/cm	100 mV/(mS/cm)
0 to 2 S/cm	1 mV/(mS/cm)
-50 to +150 °C	10 mV/°C

If the recorder output has been set for printer control, a voltage of approx. 1.5 V lies across its output. By short-circuiting (current approx. 1.5 mA), e.g. using a foot switch, you can print out the currently measured values.

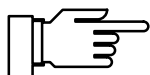

Do not apply an external voltage to the recorder output. The meter might be damaged.

Serial interface

The Model 703 comes with an RS 232 interface. The interface can be defined for direct control of the ZU 0244 Lab Printer or a commercially available printer with serial port, or as a direct connection to a computer. The conductivity meter is completely computer controllable and all values and parameters can be read out.

Interface parameters

The RS 232 interface is user-definable for all common baud rates and data protocols. Settings are made on the Parameter level.

- Baud rate: 600 Bd
1200 Bd
2400 Bd
4800 Bd
9600 Bd

- Data format:

Data word length	Parity	Stop bit
7 bits	even	1
7 bits	odd	1
8 bits	none	1

- Protocol: No protocol
XON/XOFF Bidirectional handshake
If not ready to accept data
the meter transmits XOFF < 13 > H,
if ready to accept data,
XON < 11 > H

Pin assignment

The conductivity meter has a 9-pin D SUB connector (connector with pin contacts). The metallic connector shell is connected to signal ground via a capacitor and provides EMI shielding.

Contact	Signal	Input/Output
2	(RD) Received data	Input
3	(TX) Transmitted data	Output
5	(SGND) Signal ground	
4,6,8	Jumpered	

Interface cable

Knick offers one interface cable each as accessory for connecting the conductivity meter to a computer (PC) and to the ZU 0244 Lab Printer.

- ZU 0152 interface cable for connecting the conductivity meter to a computer (PC):

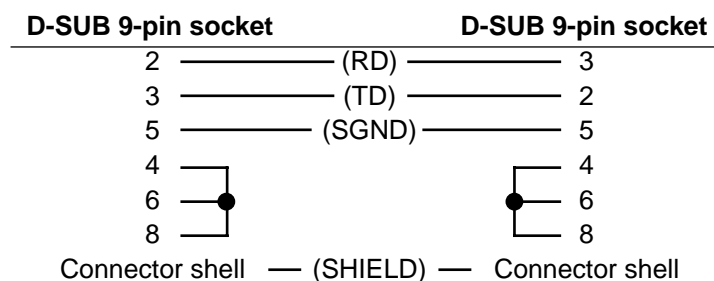

- ZU 0245 interface cable for connecting the conductivity meter to the ZU 0244 Lab Printer.

Standard settings for ZU 0244 Lab Printer

Setting on the conductivity meter

Parameter	Value to be set	Setting
Baud rate	4800 Bd	4800
Data format	7 data bits, parity even	7 EV
Protocol	XON/XOFF	XON
Interface	Printer	PRNT

Command set for the serial interface

The conductivity meter's command set is divided into read and write commands.

- Read commands start with "R". (read). They read out data from the conductivity meter. Read commands always return a response. Device function is not affected.
- Write commands start with "W". They send commands and parameters to the conductivity meter. A write command modifies device settings or parameters. The meter does not return a response. Acknowledgement of write commands can be enabled with the "WPMSR1" command. Then the meter will return "CR" (carriage return <0D> H) after each write command.

Message terminator

Message terminators for read and write

- Read: The conductivity meter terminates the string by "CR" (carriage return <0D> H).
- Write: The conductivity meter expects "CR" or "LF" (line feed <0A> H) or any combination of these as message terminator.

Numerical parameters

Format of a numerical parameter

- Mantissa:
preceded by +, -, blank or without sign
up to 14 valid digits incl. sign
Decimal point or comma floating or without
- Exponent:
"E" indicates exponent beginning
+ or - sign
1 to 3 digits
Exponent may be omitted.

Example: +1234567E-123

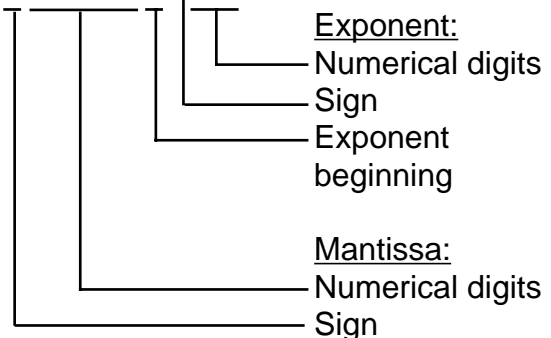

Reading measured values or results

Com-mand	Response	Unit	Description
RV2	± xxx.x	[°C]	Temperature Pt1000 /NTC 30 kΩ
RV3	xxxxE-x	[S/cm]	Conductivity
RVTRT	xxxx	[hhmm]	Time: hours/minutes
RVDRT	xxxxxx	[ddmmyy]	Date: day/month/year
RVTMA	xxxx	[h]	GLP timer count

Reading operating states

Com-mand	Response	Description
RSP	xx	Operating states
	00	Measuring mode
	01	Parameter mode
	02	Calibration mode
	08	Diagnostics mode

Reading error messages

Command	Response	Description
RSF1	xx	First error message
RSFA	xx;xx;xx;...	All active error messages

List of error messages (xx):

List of error messages (xx):



01	Conductivity range >2 S
03	°C range -50. to +150 °C exceeded
06	Cell constant < 0.001 cm ⁻¹ or > 199.9 cm ⁻¹
07	Measured values during calibration unstable
08	No solution found or solution not defined for temperature
20	Interface error
90	System failure

Reading Sensoface[®] states

Command	Response	Description
RSES	x	Sensoface [®] display
RSEPL	x	Sensoface [®] : Polarization
RSETO	x	Sensoface [®] : Temperature compensation
RSETM	x	Sensoface [®] : GLP timer
RSEBT	x	Sensoface [®] : Battery state
RSEDT	x	Sensoface [®] : Date/time

Sensoface[®] messages

List of Sensoface[®] messages (x):

0	
1	
2	

Query keypad

Command	Response	Description
RSK	xx	Query keypad
	00	cal key
	01	print key
	02	▲ key
	03	meas key
	04	on/standby key
	05	enter key
	06	par key
	07	diag key
	08	▼ key
	09	▶ key

Reading results of Knick Fullcheck[®] self test

Command	Response	Unit	Description
RSTET	xxxx	[hhmm]	Last Fullcheck/time
RSTED	xxxxxx	[ddmmyy]	Last Fullcheck/date
RSTERR	x		RAM test
RSTERP	x		EPROM test
RSTERE	x		EEPROM test
RSTEROV	x		Measuring circuit test
RSTERA	x		Amplifier test
RSTERBT	x		Battery test
RSTERDI	x		Display test
RSTERKY	x		Keypad test

List of test results

0	ok (display test executed)
1	Test not executed
2	Defective

Reading calibration data

Command	Response	Unit	Description
RSCPP	x		Last calibration:
	0		Input of cell constant
	1		Automatic calibration
RSCPT	xxxx	[hhmm]	Last calibration/time
RSCPD	xxxxxx	[ddmmyy]	Last calibration/date
RSCP3	xxxxE-x	[S/cm]	Conductivity of calibration solution
RSCP2	xxx	[°C]	Calibration temperature
RSCPRT	xxxx	[s]	Response time

Reading parameters

Command	Response	Unit	Description
RPTMMV	± xxx.x	[°C]	Manual temperature
RPTCS	x		Temp compensation on/off
	0		Off
	1		On
RPTCVR	xx.xx	[%/K]	Temp comp., TC
RPTCR			Temp comp., reference temp
	0		20 °C
	1		25 °C
RPDIE	x		Sensoface® on/off
	0		Off
	1		On
RPMRS	x		Range selection auto/fix
	0		Fix
	1		Auto
RPMRA	x		Measurement range
	0		0000 2000 mS/cm
	1		000.0 999.9 mS/cm
	2		00.00 99.99 mS/cm
	3		0.000 9.999 mS/cm
	4		000.0 999.9 µS/cm
	5		00.00 99.99 µS/cm
	6		0.000 9.999 µS/cm
RPCAC	xxx.x	[cm ⁻¹]	Cell constant
RPCAMA	x		Calibration solution
	1		NaCl
	2		KCl
RPCAM1	x		Parameter-setting solution NaCl, concentration
	0		Saturated
	1		0.1 mol/l
	2		0.01 mol/l
RPCAM2	x		Parameter-setting solution KCl, concentration
	0		1 mol/l
	1		0.1 mol/l
	2		0.01 mol/l
RPMATI	xxxx	[h]	GLP timer interval
RPAINA	x		Assignment of recorder output
	2		Temperature
	30		Cond, 0 to 20 µS/cm
	31		Cond, 0 to 2 mS/cm
	32		Cond, 0 to 20 mS/cm
	33		Cond, 0 to 20 S/cm
	8		Input for printer control
RPINPTI	xxx.x	[min]	Print timer interval

Command	Response	Unit	Description
RPMSR	x		Response to write command on/off
	0		Off
	1		On

Writing parameters

Command	Parameter	Unit	Description
WPTMMV	Num. par.	[°C]	Manual temperature
WPTCS	x		Temp compensation on/off
	0		Off
	1		On
WPTCVR	Num. par.	[%/K]	Temp comp., TC
WPTCR			Temp compensation, reference temperature
	0		20 °C
	1		25 °C
WPDIE	x		Sensoface [®] on/off
	0		Off
	1		On
WPMRS	x		Range selection auto/fix
	0		Fix
	1		Auto
WPMRA	x		Measurement range
	0		0000 to 2000 mS/cm
	1		000.0 to 999.9 mS/cm
	2		00.00 to 99.99 mS/cm
	3		0.000 to 9.999 mS/cm
	4		000.0 to 999.9 µS/cm
	5		00.00 to 99.99 µS/cm
	6		0.000 to 9.999 µS/cm
WPCAC	Num. par.	[cm ⁻¹]	Cell constant
WPCAMA	x		Calibration solution
	1		NaCl
	2		KCl
WPCAM1	x		Parameter-setting solution NaCl, concentration
	0		Saturated
	1		0.1 mol/l
	2		0.01 mol/l
WPCAM2	x		Parameter setting solution KCl, concentration
	0		1 mol/l
	1		0.1 mol/l
	2		0.01 mol/l
WPMATI	Num. par.	[h]	GLP timer interval

Command	Parameter	Unit	Description
WPAINA	x		Assignment of recorder output
	2		Temperature
	30		Cond, 0 to 20 μ S/cm
	31		Cond, 0 to 2 mS/cm
	32		Cond, 0 to 20 mS/cm
	33		Cond, 0 to 20 S/cm
	8		Input for printer control
	WPINPTI	Num. par.	[min]
WPMSR	x		Response to write command on/off
	0		Off
	1		On

Control commands

Command	Description
WCIU	Initialize device
WCTEA	Perform Fullcheck
WCRTT [hhmm]	Set time
WCRTD [ddmmyy]	Set date
WCOM00	Switch to measuring mode
WCCAA1	Start automatic calibration
WCDISRA2	Right display, indicate temperature
WCDISRATRT	Right display, indicate time
WCDISRATC	Right display, indicate TC

Reading device description

Command	Response	Description
RDMF	KNICK	Manufacturer
RDUN	703	Model name
RDUS	xxxxxx	Serial number
RDUV	xx;xx	Software/hardware version
RDUP	xxx;xxx;xxx	Options

3 Troubleshooting

Error messages

Range exceeded

If a measured value is out of range, an error message is displayed instead of the value measured.

ERR --LF--

The measured conductivity is $> 2,0 \text{ S/cm}$.

Possible causes:

- Cell constant entered incorrectly

ERR TEMP

The measured temperature is $< -50 \text{ °C}$ or $> +150 \text{ °C}$ for Pt 1000
 $< -20 \text{ °C}$ or $> +120 \text{ °C}$ for NTC

Possible causes:

- Temperature probe defective

OVFL $\mu\text{S/cm}$ 25.0 $^{\circ}\text{C}$

The manually preset range is exceeded. The flashing decimal point and the displayed measurement unit mS/cm or $\mu\text{S/cm}$ indicates the selected range. A different range can be selected with ▲.

Calibration error messages

When errors occur during calibration or when the determined cell constant is out of range, an error message is displayed.

ERR INST

The sensor fails to provide a stable measured value.

Possible causes:

- Temperature fluctuation of calibration solution

ERR CELL

The determined cell constant is $< 0.001 \text{ cm}^{-1}$ or $> 199.0 \text{ cm}^{-1}$.

Possible causes:

- Wrong calibration solution used

ERR SOL

The calibration solution is not defined for this temperature.

Interface error message

When errors occur during transmission via interface, an error message is displayed.

ERR INTF

The meter has received an invalid interface command.

Possible causes:

- Syntax error in interface command
- Too many characters in one string
- No valid message terminator
- Wrong transmission rate (baud rate) selected
- Wrong data word length or parity selected
- Wrong transmission protocol (handshake) selected
- Interference during transmission

System error message

When a system error is found during the self test, an error message is displayed.

ERR SYST

Error in the factory settings.

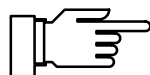

This error message normally should not occur, as the data are protected from loss by multiple safety functions.

Should this error message nevertheless occur, there is no remedy. The meter must be recalibrated at the factory.



Opening the meter exposes live parts. Therefore, it shall not be opened. If a repair should be required, return the device to our factory.

Maintenance and cleaning

The Model 703 contains no user repairable components.

To remove dust, dirt and spots, the external surfaces of the meter may be wiped with a damp, lint-free cloth. A mild household cleaner or 2-propanol (isopropyl alcohol) may also be used if necessary.

Appendix

Product line

		Ref. No.
Device	Conductivity meter with power cord, without sensor	703
	4-electrode sensor with integrated Pt 1000 temperature probe	ZU 6985
Accessories	KPG [®] tube for 4-electrode sensor incl. O ring	ZU 0180
	Calibration solution for determination and checking of cell constants (1 ampoule for producing 1 l NaCl solution 0.1 mol/l)	ZU 6945
	Temp probe, Pt 1000 ^{*)} , stainless steel, -10 to +100 °C	ZU 6959
	Attachable stand accepting any four sen- sors, attached directly to conductivity meter	ZU 6954
	Lab Printer	ZU 0244
	Interface cable for connecting the Model 703 to a printer (ZU 0244)	ZU 0245
	Interface cable for connecting the Model 703 to a computer (special EMC cable)	ZU 0152
	Adapter for connecting the SE 202 and SE 204 sensors	ZU 0298
Options	Power supply 115 V AC	363

*) For 2-electrode sensors without Pt 1000 or NTC 30 kΩ temp probe

Specifications

Ranges	Cond: 0.000 to 9.999 $\mu\text{S}/\text{cm}$ 00.00 to 99.99 $\mu\text{S}/\text{cm}$ 000.0 to 999.9 $\mu\text{S}/\text{cm}$ 0.000 to 9.999 mS/cm 00.00 to 99.99 mS/cm 000.0 to 999.9 mS/cm 0000 to 2000 mS/cm Auto-ranging or manual setting ^{*)} $^{\circ}\text{C}$: Pt 1000: -50.0 to $+150.0$ NTC 30 $\text{k}\Omega$: -20.0 to $+120.0$
Display	Alphanumeric 2 x 4-digit, 14-segment LED, character height 13 mm, Measurement symbols: 20°C , 25°C , $\mu\text{S}/\text{cm}$, mS/cm , $\%/K$, $^{\circ}\text{C}$, time 3 Sensoface [®] status indicators inform on sensor condition and measuring equipment (GLP)
Measuring cycle	Approx. 1.5/sec
Measuring frequencies	Approx. 40 Hz to 2 kHz, automatic adjustment by conductance
Resolution	Up to 0.001 $\mu\text{S}/\text{cm}$
Accuracy ^{**)}	Cond: $< 0.5\%$ meas. value ± 2 counts $^{\circ}\text{C}$: $< 0.3\text{ K}$
Reproducibility ^{**)}	$< 0.1\%$ measured value
Temperature compensation	Pt 1000: -50 to $+150\text{ }^{\circ}\text{C}$, NTC 30 $\text{k}\Omega$: -20 to $+120\text{ }^{\circ}\text{C}$, Pt 1000/NTC 30 $\text{k}\Omega$ (autom. selection) or manual, Linear TC characteristic 0.00 to $+9.99\%/K$, Reference temperature $20\text{ }^{\circ}\text{C}/25\text{ }^{\circ}\text{C}$ selectable
Adm. cell constant	0.001 to 199.9 cm^{-1} , selectable
Sensor standardization	Operating modes <ul style="list-style-type: none"> – Automatic by cell constant determination with NaCl or KCl solution Calibration solutions: KCl 0.01 mol/l; 0.1 mol/l; 1 mol/l; NaCl 0.01 mol/l; 0.1 mol/l; saturated – Manual calibration by input of cell constant
Monitoring of sensor and measuring equipment (GLP)	Sensoface [®] provides information: <ul style="list-style-type: none"> – for selection of 2-electrode sensors – on too great a difference between reference and measuring temperature – on battery charging level – on clock memory loss – in case of irregular checking of measuring equipment Optical display: Good / average / poor
Device self-test	Test of measuring electronics including recorder output, battery charging level, segment and keypad test, RAM, EPROM and EEPROM test in Diagnostics menu, Automatic short check at power-on
GLP records (ISO 9000)	Parameter settings, calibration, device diagnostics

Recorder output	Galvanically isolated (isolation voltage: 40 V DC, 20 V AC) Cond: 100 mV/ μ S·cm ⁻¹ 1 mV/ μ S·cm ⁻¹ 100 mV/mS·cm ⁻¹ 1 mV/mS·cm ⁻¹ °C: 10 mV/°C User-definable for printer control
Remote interface	RS 232 without control lines, galvanically isolated (isolation voltage: 40 V DC, 20 V AC), user-definable as printer or computer interface, Baud rate: 600/1200/2400/4800/9600 *) Data bit/parity: 7/even, 7/odd, 8/no *) Protocol: None, XON/XOFF *) Stop bits: 1
Clock	Real-time clock with date, self-contained
Calibration data storage	Automatic storage of cell constant and calibration procedure with time and date stamp, self-contained
Data retention	Parameters and factory settings >10 years (EEPROM), Clock (reserve power) > 1 year (battery-backed)
EMC	2004/108/EC Emitted interference: Class B Immunity to interference: Industry Standards: DIN EN 61326 -1 (VDE 0843 Part 20-1): 2006-10 DIN EN 61326-2-3(VDE 0843 Part 20-2-3): 2007-05
Low voltage directive	2006/95/EC Standards: EN 61010-1: 2001
Ambient temperature	Operation: 0 to +45 °C Transport and storage: -20 to +70 °C
Power supply	230 V AC -15%, +10 %, 48 to 62 Hz, < 10 VA, Protection Class II Option 363: 115 V AC
Enclosure	Glass-reinforced polyamide 12, stainless steel cover, IP 54 protection, prepared for connecting ZU 6954 attachable stand
Dimensions (W x H x D)	244 x 95 x 255 mm
Weight	Approx. 2 kg

*) User-defined

**) ±1 count

ZU 6985 4-electrode sensor

Ranges	x: <1.00 $\mu\text{S}/\text{cm}$ to >1000 mS/cm . t: -20 ... +100 °C	
Material	System carrier: 4 ring electrodes: Protective tube (16 mm dia., replaceable):	glass platinum, bare KPG [®] glass,
Immersion depth	min/max 60/80 mm	
Temperature probe	Pt 1000, fast reacting	
Cell constant	Approx. 1 cm^{-1}	
Connecting cable length	Approx. 1 m	

Calibration solution tables

NaCl solution

Temperature [°C]	Conductivity [mS/cm] 0.01 mol/l	Conductivity [mS/cm] 0.1 mol/l	Conductivity [mS/cm] Saturated
0	0.631	5.786	134.5
1	0.651	5.965	138.6
2	0.671	6.145	142.7
3	0.692	6.327	146.9
4	0.712	6.510	151.2
5	0.733	6.695	155.5
6	0.754	6.881	159.9
7	0.775	7.068	164.3
8	0.796	7.257	168.8
9	0.818	7.447	173.4
10	0.839	7.638	177.9
11	0.861	7.831	182.6
12	0.883	8.025	187.2
13	0.905	8.221	191.9
14	0.927	8.418	196.7
15	0.950	8.617	201.5
16	0.972	8.816	206.3
17	0.995	9.018	211.2
18	1.018	9.221	216.1
19	1.041	9.452	221.0
20	1.064	9.631	226.0
21	1.087	9.839	231.0
22	1.111	10.047	236.1
23	1.135	10.258	241.1
24	1.159	10.469	246.2
25	1.183	10.683	251.3
26	1.207	10.898	256.5
27	1.232	11.114	261.6
28	1.256	11.332	266.9
29	1.281	11.552	272.1
30	1.306	11.773	277.4
31	1.331	11.995	282.7
32	1.357	12.220	288.0
33	1.382	12.445	293.3
34	1.408	12.673	298.7
35	1.434	12.902	304.1
36	1.460	13.132	309.5

KCl solution

Temperature [°C]	Conductivity [mS/cm] 0.01 mol/l	Conductivity [mS/cm] 0.1 mol/l	Conductivity [mS/cm] 1 mol/l
0	0.776	7.15	65.41
1	0.800	7.36	67.13
2	0.824	7.57	68.86
3	0.848	7.79	70.67
4	0.872	8.00	72.37
5	0.896	8.22	74.14
6	0.921	8.44	75.93
7	0.945	8.66	77.73
8	0.970	8.88	79.54
9	0.995	9.11	81.36
10	1.020	9.33	83.19
11	1.045	9.56	85.04
12	1.070	9.79	86.89
13	1.095	10.02	88.76
14	1.121	10.25	90.63
15	1.147	10.48	92.52
16	1.173	10.72	94.41
17	1.199	10.95	96.31
18	1.225	11.19	98.22
19	1.251	11.43	100.14
20	1.278	11.67	102.07
21	1.305	11.91	104.00
22	1.332	12.15	105.94
23	1.359	12.39	107.89
24	1.386	12.64	109.84
25	1.413	12.88	111.80
26	1.441	13.13	113.77
27	1.468	13.37	115.74
28	1.496	13.62	
29	1.524	13.87	
30	1.552	14.12	
31	1.581	14.37	
32	1.609	14.62	
33	1.638	14.88	
34	1.667	15.13	
35	1.696	15.39	
36		15.64	

Glossary

2-electrode sensor	Sensor with electrodes at which current and voltage are measured together. Usually with 2 electrodes, but also with 3 electrodes (two interconnected electrodes screen the third electrode).
4-electrode sensor	Sensor with four electrodes for separate measurement of voltage and current.
cal	Key for activating the Calibration level.
Calibration	Adjustment of the conductivity meter to the sensor used by determining the cell constant of the sensor.
Calibration level	On the Calibration level the meter is adjusted for the connected conductivity sensor (calibration). You can either perform an automatic calibration or manually enter the cell constant.
Calibration record	Printout of all relevant data of the last calibration for documentation to GLP. Start printout by pressing cal and print .
Calibration solution	Solution with defined conductivity. Various calibration solutions are stored in the meter with the proper temperature and can thus be used for automatic calibration.
Cell constant	Variable for calculating the electrolytic conductivity through multiplication with the measured conductance.
diag	Key for activating the Diagnostics level.
Diagnostics level	Display of criteria for Sensoface [®] display and activation of Fullcheck [®] device self test.
Diagnostics record	Printout of criteria for Sensoface [®] display and results of Fullcheck [®] device self test for documentation to GLP. Start printout by pressing diag and print .

Electrolytic conductivity

Conductance multiplied by the cell constant. The conductance is the reciprocal resistance of electrically conductive electrolyte solutions, usually measured with alternating current.

enter

Key for confirming entries.

GLP

Good Laboratory Practice: Guidelines for performance and documentation of measurements in the laboratory.

GLP timer

Measures the time since the last device self-test.

Knick Fullcheck[®]

Device self test, checks complete measuring circuitry, signal processing, memories, display, and keypad.

meas

This key allows return to measuring mode from all other levels.

Measuring mode

When no function level is activated, the meter is in measuring mode. The two displays indicate the respectively assigned variable.

par

Key for activating the Parameter level.

Parameter level

The Parameter level is divided into two submenus. VIEW menu and EDIT menu. The VIEW menu allows to display all parameters without editing them. The EDIT menu allows to view and edit all parameters.

Parameter record

Printout of all stored parameter settings for documentation to GLP. Start printout by pressing **par** and **print**.

Polarization

Nonlinearity of the measured value due to a high current density at the electrodes. Polarization limits the application range of 2-electrode sensors at higher conductivities.

Print interval timer

The print interval timer allows to preset an interval for printout of currently measured values with time and date.

Reference temperature	Temperature to which the conductivity is converted for temperature compensation.
Sensoface[®]	Automatic monitoring system. The Sensoface [®] indicators provide information on sensor selection and handling.
Temperature coefficient	Change of conductivity with temperature in %/K.
Temperature compensation	Conversion of the conductivity determined at the measuring temperature to the conductivity the solution would have at the reference temperature.

Index

4-electrode sensor, ZU 6985
Specifications, 46

A

Accessories, 43
Automatic calibration, 23

C

Calibration, 22
Calibration level, 22
Calibration record, 25
Calibration solution tables, 47
Cell constant input, 23
Cleaning, 42
Commissioning, 7
Connection
Mains, 7
Sensor, 7

D

Device self-test, 28
Diagnostics, 26
Knick Fullcheck menu, 26, 28
Sensoface menu, 26
Diagnostics level, 26
Diagnostics record, 30

E

EDIT menu, 15
Error messages, 40

G

Glossary, 49
GLP timer setting, 19

I

Interface cable, 33
Interface commands, 33
Interface parameters, 32

K

Keypad, 4
Knick Fullcheck menu, 26, 28

M

Mains supply, 7
Maintenance, 42
Manual temperature input, 18
Measuring mode, 8
Menu structure, 6

O

Options, 43

P

Package contents, 1
Parameter level, 15
Parameter record, 17
Parameter setting
Activation, 15
EDIT menu, 15

- Example, 16
- VIEW menu, 15
- Parameters,, 15
- Print interval timer, 21
- Printer, ZU 0244
 - Standard settings, 33
- Printing
 - Calibration record, 25
 - Diagnostics record, 30
 - Measured values, 9
 - Parameter record, 17
- Product line, 43

R

- Range selection
 - Automatic, 19
 - Manual, 5, 19
- Recorder output, 31
 - Setting, 20
- Reference temperature input, 18
- Remote interface, 32
 - Cable, 33
 - Commands, 33
 - Parameters,, 32
 - Pin assignment, 32
 - Setting, 20
- RS 232 interface, 32

S

- Safety information, III
- Sensoface, 6
- Sensoface menu, 26
- Sensoface sensor monitoring, 2, 6
- Sensor connection, 7
- Short check, 8
- Short description, 1
- Short instructions, 10
- Specifications, 44
- Standby mode, 8

T

- TC input, 18
- Temperature coefficient input, 18
- Temperature compensation
 - Reference temperature, 18
 - Setting, 18
 - Temperature coefficient, 18
- Temperature detection, manual, 18

V

- VIEW menu, 15

Z

- ZU 0244 Lab Printer
 - Standard settings, 33