

Protos II 4400(X) / Protos 3400(X) Process Analysis System

User Manual

Protos COND 3400(X)-041 Measuring Module
For Conductivity Measurement with
2- or 4-Electrode Sensors

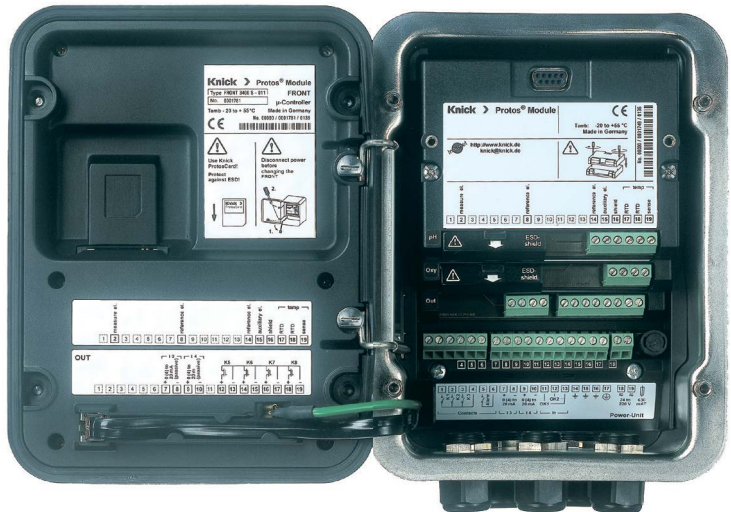

Returns

Clean and securely package the product before returning it to Knick Elektronische Messgeräte GmbH & Co. KG if required.

If there has been contact with hazardous substances, the product must be decontaminated or disinfected prior to shipment. The consignment must always be accompanied by a corresponding return form to prevent service employees being exposed to potential hazards.

Further information can be found at www.knick.de.

Disposal

The local codes and regulations must be observed when disposing of the product.

Table of Contents

Protos COND 3400(X)-041 Module

Returns.....	2
Disposal	2
Intended Use.....	5
Safety Instructions	6
Operation in Explosive Atmospheres: COND 3400X-041 Module	6
Firmware Version	7
Terminal Plate COND 3400-041 Module.....	9
Installing the Module	10
Wiring Examples.....	11
Calibration / Adjustment	19
Temperature Compensation	21
HOLD Function During Calibration	22
Automatic with Standard Calibration Solution.....	24
Manual Entry of Calibration Solution	26
Product Calibration (Calibration by Sampling)	28
Data Entry of Premeasured Sensors.....	30
Sensor Calibration.....	31
Temp Probe Adjustment.....	32
Parameter Setting	33
Parameter Setting: Operating Levels.....	34
Parameter Setting: Locking a Function	35
Default Settings and Selection Range.....	37
TC Process Medium	38
Parameter Setting: Concentration Curves	39
Concentration Table	43
USP Function.....	44
Calculation Blocks	45
pH Value Calculation.....	48
Logbook.....	50
Restore Factory Settings.....	50
Configuring the Current Output.....	53
Current Outputs: Characteristics	54
Current Outputs: Output Filter.....	56

Table of Contents

Protos COND 3400(X)-041 Module

Maintenance	57
Sensor Monitor.....	57
Temp Probe Adjustment.....	57
Diagnostic Functions	59
Point of Meas Description.....	59
Logbook.....	59
Module Diagnostics.....	60
Sensor Monitor.....	60
Calibration/Adjustment Record.....	60
Temp. Offset Log	60
Device Description	61
FRONT Module	61
BASE Module.....	61
Setting Diagnostic Messages as Favorite	62
Message list	64
Specifications.....	71
Appendix.....	75
Minimum Spans for Current Outputs.....	75
Overview	76
Overview of Parameter Setting.....	76
Index	80

Intended Use

The module is an input module for conductivity measurement with commercially available 2- or 4-electrode sensors.

The COND 3400X-041 module is intended for operation in locations subject to explosion hazards which require equipment of Group II, device category 2(1), gas/dust.

Safety Instructions

Operation in Explosive Atmospheres: COND 3400X-041 Module

The module is approved for operation in explosive atmospheres.

When installing the product in a hazardous location, observe the information in the supplements to the certificates and, if applicable, the relevant control drawings.

Observe all applicable local and national codes and standards for the installation of electrical equipment in explosive atmospheres. For orientation, please refer to IEC 60079-14, EU directives 2014/34/EU and 1999/92/EC (ATEX), NFPA 70 (NEC), ANSI/ISA-RP12.06.01.

⚠ WARNING! Possible impairment of explosion protection.

- Modules which have already been used shall be subjected to a professional routine test before they may be operated in another type of protection.
- Prior to commissioning, the operating company must verify the intrinsic safety in accordance with the installation regulations of IEC 60079-14 for the complete interconnection of all equipment involved, including the connecting cables.
- The interconnection of Ex and non-Ex modules (mixed assembly) is not permitted.
- In hazardous locations the device shall only be cleaned with a damp cloth to prevent electrostatic charging.

Maintenance

The Protos modules cannot be repaired by the user. For inquiries regarding module repair, please contact Knick Elektronische Messgeräte GmbH & Co. KG at www.knick.de.

Firmware Version

COND 3400(X)-041 module firmware: Firmware version 2.x

Module compatibility	COND3400-041	COND3400X-041
Protos 3400 from FRONT firmware version 1.0	x	
Protos 3400X from FRONT firmware version 4.0		x
Protos II 4400 from FRONT firmware version 01.00.00	x	
Protos II 4400X from FRONT firmware version 01.00.00		x

Further information on the firmware version history can be found at www.knick.de.

Query Device Firmware/Module Firmware

When the device is in measuring mode:

Press **menu** key, open Diagnostics menu: Device Description

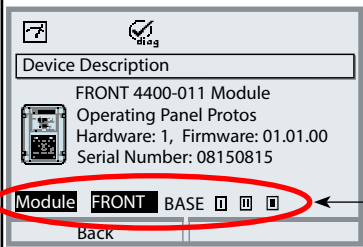
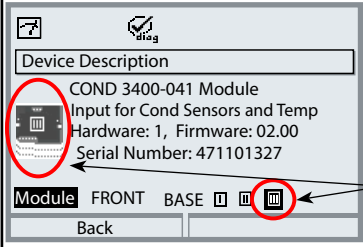
Menu	Display	Action
 diag	 <p>Device Description</p> <p>FRONT 4400-011 Module Operating Panel Protos Hardware: 1, Firmware: 01.01.00 Serial Number: 08150815</p> <p>Module FRONT BASE [] [] []</p> <p>Back</p>	<p>Device hardware and firmware version</p> <p>Provides information on all modules installed: Module type and function, serial number, hardware and firmware version, and device options.</p> <p>Select the different modules (FRONT, BASE, slots 1 - 3) using the arrow keys.</p>
	 <p>Device Description</p> <p>COND 3400-041 Module Input for Cond Sensors and Temp Hardware: 1, Firmware: 02.00 Serial Number: 471101327</p> <p>Module FRONT BASE [] [] []</p> <p>Back</p>	<p>Query module firmware</p> <p>Module COND 3400-041, hardware and firmware version, serial number – here installed in slot 3.</p>

Note: The display may vary depending on the device version.

Terminal Plate COND 3400-041 Module

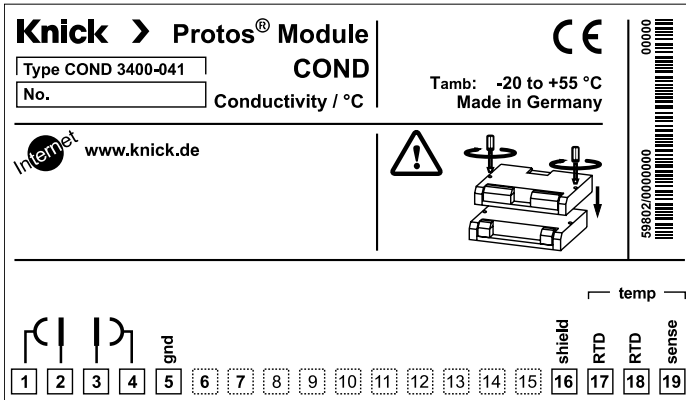

Attaching the Terminal Plates

The terminal plates of the lower modules can be stuck to the inner side of the door. This facilitates maintenance and service.



Installing the Module

⚠ CAUTION! Electrostatic discharge (ESD).

The modules' signal inputs are sensitive to electrostatic discharge. Take measures to protect against ESD before inserting the module and wiring the inputs.

NOTICE! Strip the insulation from the wires using a suitable tool to prevent damage.



- 1) Switch off the power supply to the device.
- 2) Open the device (loosen the 4 screws on the front).
- 3) Plug the module into the slot (D-SUB connector), see figure.
- 4) Tighten the module's fastening screws.
- 5) Connect the sensor and separate temperature probe if necessary, see "Wiring Examples".
- 6) Check whether all connections are correctly wired.
- 7) Close the device by tightening the screws on the front.
- 8) Switch on the power supply.

⚠ CAUTION! Risk of losing the specified ingress protection.

Fasten the cable glands and screw together the housing correctly. Observe the permissible cable diameters and tightening torques (see the specifications of the basic unit). Insert blanking plugs or sealing inserts if necessary.

Wiring Examples

Note: Be sure to connect the shielding properly

Wiring Example 1

Conductivity measurement with 4-electrode sensor

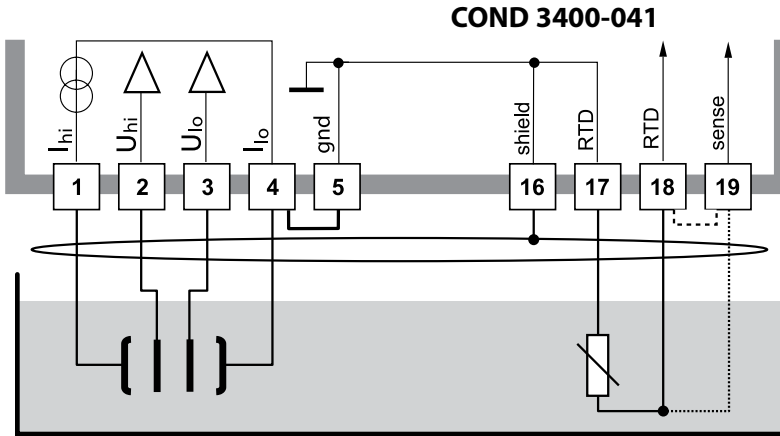

Wiring Example 2

Conductivity measurement with 2-electrode coax sensor

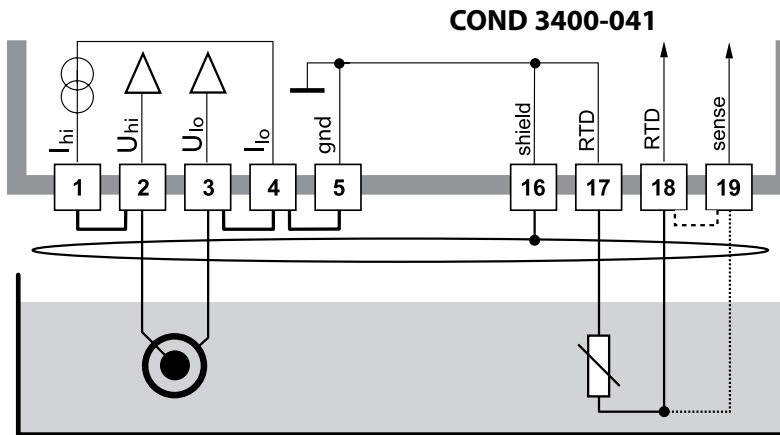

Wiring Example 3

Conductivity measurement with SE 604 2-electrode coax sensor
 Connection via Schaltbau cable

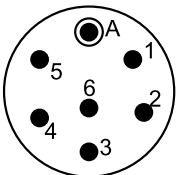
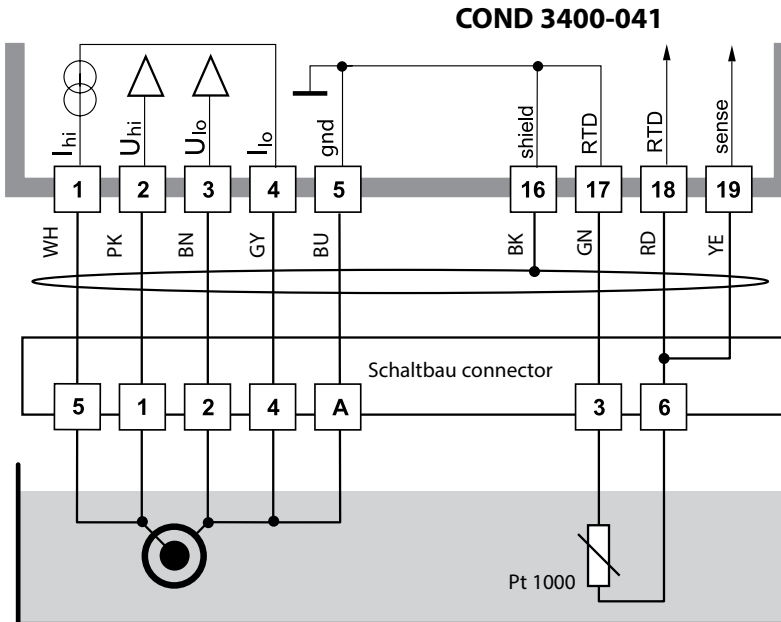

View on the sensor

Schaltbau connector

Pin	Wire color	Module terminal
1	White	2
2	Brown	3
3	Green	17
4	Gray	4
5	Pink	1
6	Red, yellow	18 and 19
A	Blue	5

Wiring Example 4

Conductivity measurement with SE 610 2-electrode sensor
Connection with pre-assembled cable with wire end ferrules

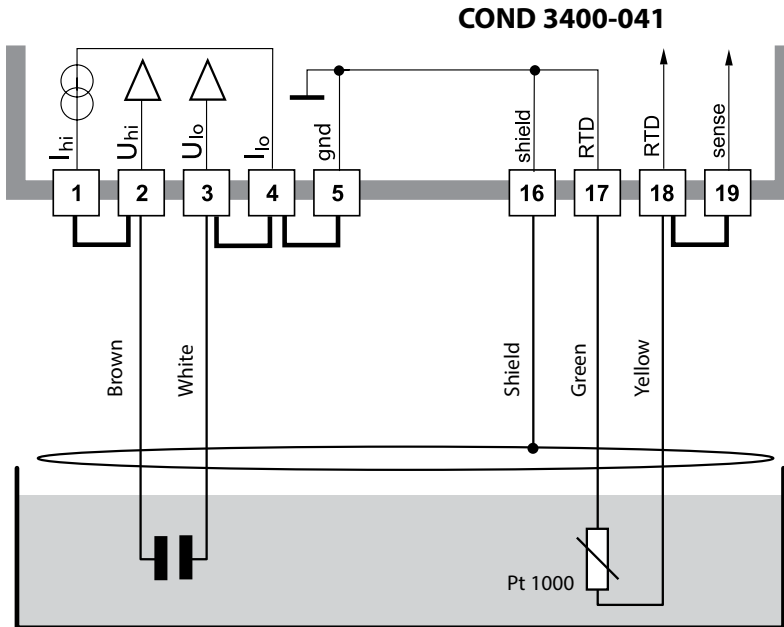

Screw clamp connection

Wire color	Module terminal
Brown	2 (jumper 1-2)
White	3 (jumper 3-4-5)
Shield	16
Green	17
Yellow	18 (jumper 18-19)

Wiring Example 5

Conductivity measurement with SE 620 2-electrode sensor
Connection with VP cable

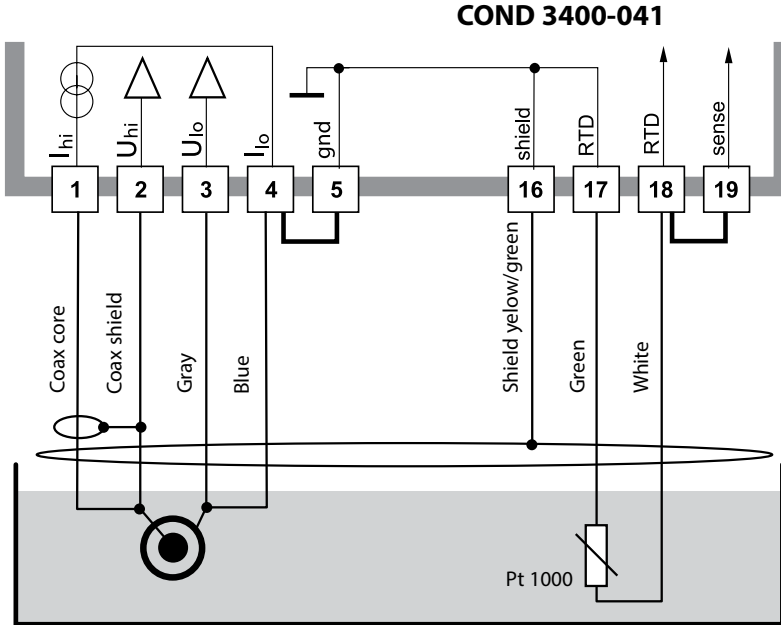

Screw clamp connection

VP cable	Module terminal
Coax core	1
Coax shield	2
Gray	3
Blue	4 (jumper 4-5)
Shield	16
Green	17
White	18 (jumper 18-19)

Wiring Example 6

Conductivity measurement with the SE 630 (ZU 0071) 2-electrode sensor
 Connection via GDM connector

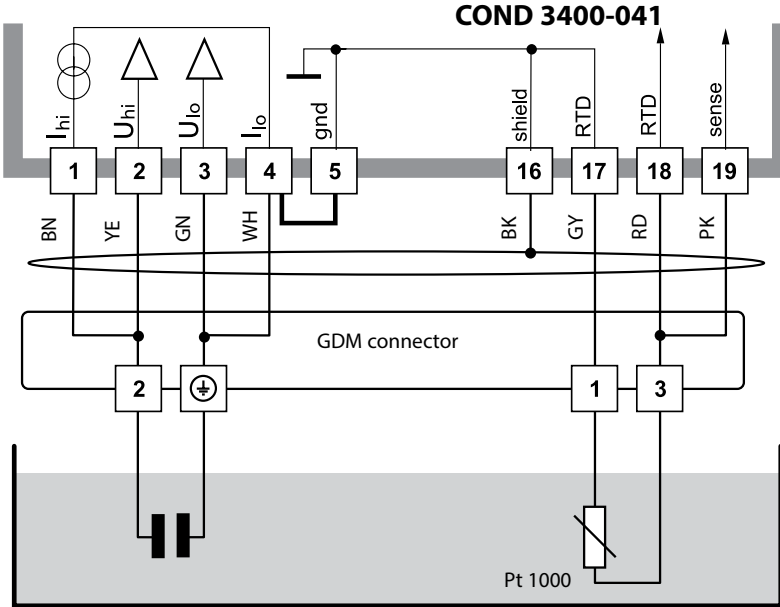

Plug-in connection: GDM

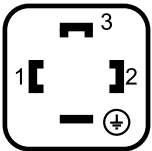

Pin	Wire color	Module terminal
1	Gray	17
2	Brown and yellow	1 and 2
3	Red and pink	18 and 19
+	Green and white	3 and 4

Wiring Example 7

Conductivity measurement with 4-electrode fringe-field sensor
(SE 600/SE 603)

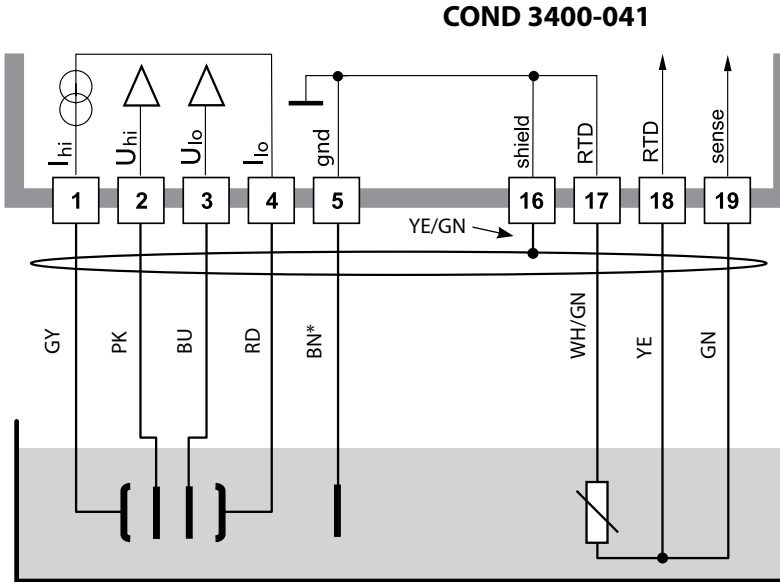

- * SE 600: Equipotential bonding, brown wire
SE 603: Additional equipotential bonding electrode
must be installed (or jumper 4-5)

Wiring Example 8

Conductivity measurement with 4-electrode sensor
Mettler-Toledo InPro 7100 series
Connection via LF-VP cable

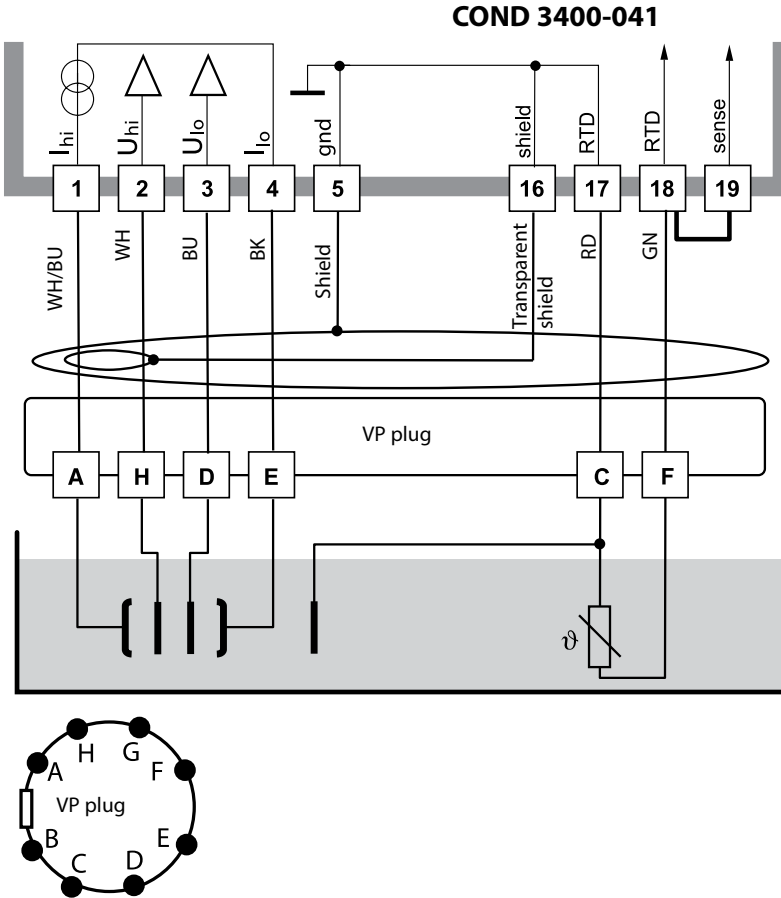

Wiring Example 9

Conductivity measurement with 2-electrode sensor
Mettler-Toledo InPro 7000 series
Connection via Thornton cable

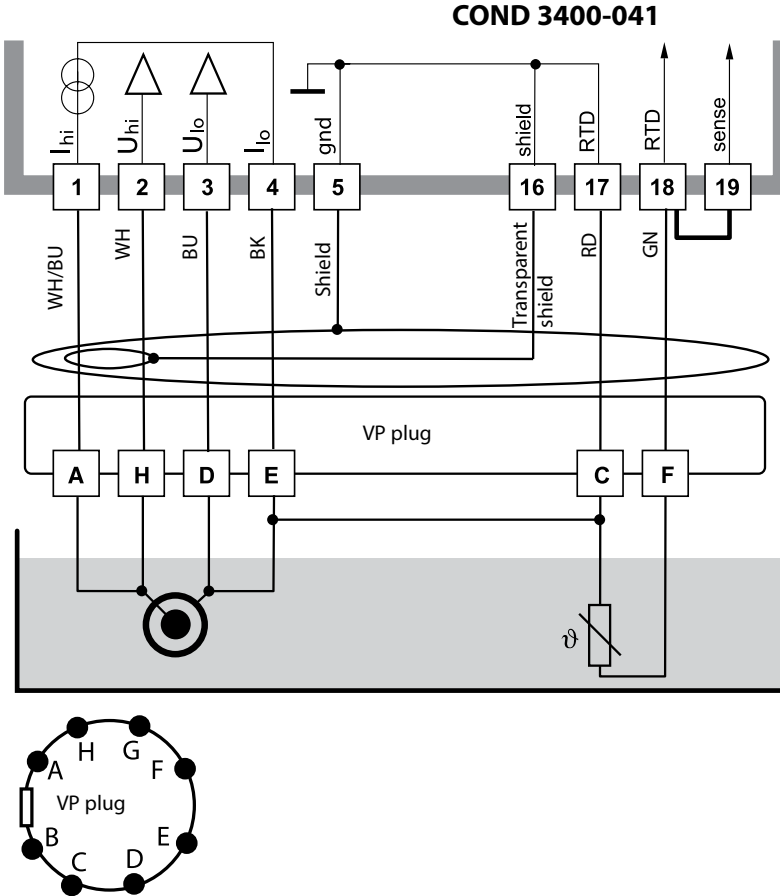

Calibration / Adjustment

Note: Function check (HOLD) active for the currently calibrated module
Current outputs and relay contacts behave as configured

- **Calibration:** Detecting deviations without readjustment
- **Adjustment:** Detecting deviations with readjustment

NOTICE!

Without adjustment every conductivity meter delivers an imprecise or wrong output value! Every conductivity sensor has its individual cell constant. To determine the correct conductivity value, the conductivity meter must be adjusted to the sensor. From the sensor signal and the cell constant, the meter calculates the conductivity value to be displayed.

Procedure

Every conductivity sensor has its individual cell constant. Depending on the sensor design, the cell constant may vary over a wide range. As the conductivity is calculated from the measured conductance and the cell constant, this must be known to the measuring system. For calibration or sensor standardization, either the known (stamped on) cell constant of the conductivity sensor used is entered in the measuring system or it is determined automatically by measuring a calibration solution with a known conductivity. The data are stored in a calibration record. By "Adjustment" the determined calibration data can be used for correction (see following page).

- Use fresh calibration solutions only!
- The calibration solution used must have been selected during parameter setting.
- Calibration accuracy decisively depends on the exact detection of the calibration solution's temperature. Using the measured or entered temperature, the Protos determines the nominal value for the calibration solution from a stored table.
- Observe response time of temperature probe!
- For exact determination of the cell constant, wait until the temperature probe and calibration solution have the same temperature.

Calibration / Adjustment

Adjustment

means that the cell constant determined by a calibration is taken over. It is entered in the calibration record. (Cal record can be called up in the Diagnostics menu for the COND 3400(X)-041 module.) The value is only effective for calculating the measured variables when the calibration has been terminated with an adjustment.

A passcode ensures that an adjustment can only be performed by an authorized person (Administrator). The Operator can check the current sensor data by a calibration and inform the Administrator when there are deviations. You can use the add-on function SW3400-107 ¹⁾ for granting access rights (passcodes) and for AuditTrail (continuous data recording and backup according to FDA 21 CFR Part 11).

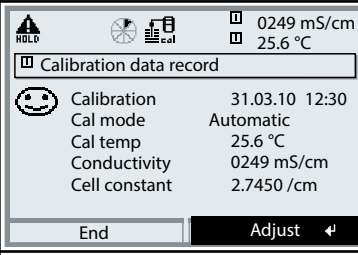
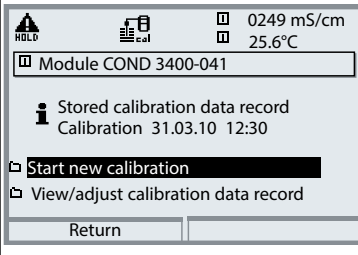
Menu	Display	Action
		<p>Administrator</p> <p>With the corresponding access rights, the device can immediately be adjusted after calibration. The calibration values are taken over for calculating the measured variables.</p>
		<p>Operator (without administrator rights)</p> <p>After calibration, change to measuring mode. Inform Administrator. When opening the menu (Calibration, respective module), the Administrator sees all data of the last calibration and can take over the values or perform a new calibration.</p>

Note: The display may vary depending on the device version.

Calibration / Adjustment

Temperature Compensation

Temperature Compensation During Calibration

The conductivity value of the calibration solution is temperature-dependent. For calibration, the calibration solution temperature must therefore be known in order to choose the actual value from the conductivity table.

During parameter setting you define whether cal temperature is measured automatically or must be entered manually.

Automatic Temperature Compensation

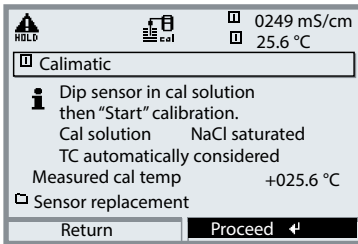

For automatic cal temp detection, the Protos measures the temperature of the calibration solution with a temperature probe (Pt 100 / Pt 1000 / NTC 30 kΩ). If you work with automatic temperature compensation during calibration, a temperature probe connected to the temperature input of the Protos must be in the calibration solution! Otherwise, you must select

manual entry of calibration temperature. When "Cal temp automatic" is set, "Measured cal temp" appears in the menu.

Manual Temperature Compensation

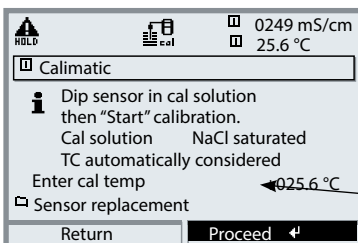

The temperature of the calibration solution must be entered manually in the Calibration menu.

When "Cal temp automatic" is set, "Measured cal temp" appears in the menu.

When "Cal temp manual" is set, "Enter cal temp" appears in the menu.

Note: The display may vary depending on the device version.

HOLD Function During Calibration

Behavior of the signal and relay outputs during calibration

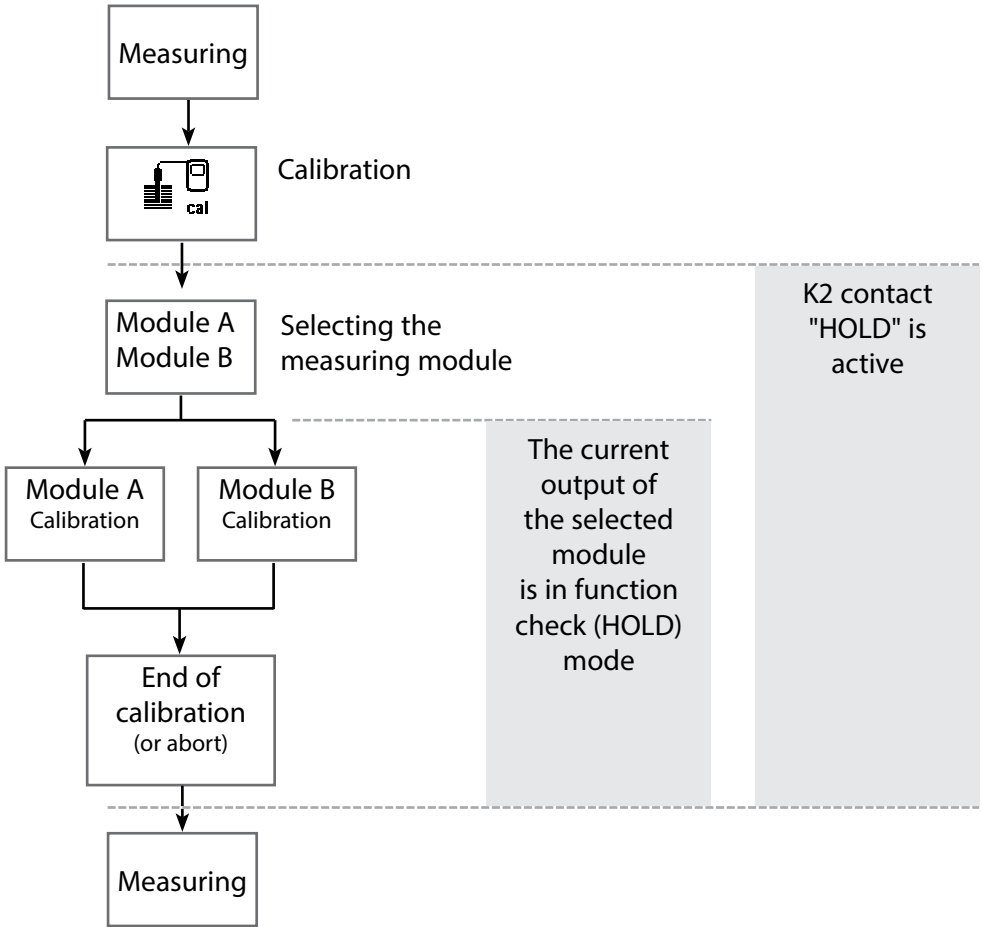

Note: The display may vary depending on the device version.

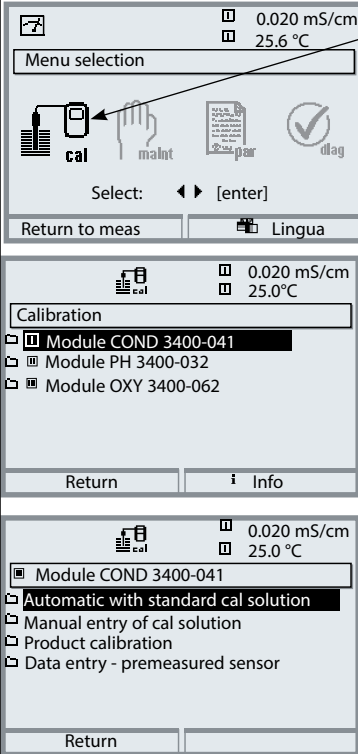
Menu	Display	Action
		<p>Open calibration Press menu key to select menu. Select calibration using arrow keys, confirm with enter, passcode 1147 (The passcode can be edited by the administrator.).</p> <p>Calibration: Select "Module COND"</p> <p>Select calibration method:</p> <ul style="list-style-type: none"> • Automatic with standard cal solution • Manual entry of cal solution • Product calibration • Data entry - premeasured sensor • Temp probe adjustment (with Protos II 4400(X)) <p>When you call up calibration, the analyzer automatically proposes the previous calibration method. If you do not want to calibrate, "Return" with the left softkey.</p> <p>During calibration the module is in function check (HOLD) mode. Current outputs and relay contacts of the module behave as configured (Module BASE).</p>

Calibration / Adjustment

Automatic Calibration with Standard Calibration Solution

Automatic with Standard Calibration Solution

For automatic calibration, the conductivity sensor is immersed in a standard calibration solution (NaCl or KCl, selected during parameter setting). From the measured conductance and temperature, the Protos automatically calculates the cell constant. The temperature dependence of the calibration solution is taken into account.

During calibration the module is in function check (HOLD) mode.

Current outputs and relay contacts of the module behave as configured (Module BASE).

NOTICE!

- Use fresh calibration solutions only! The calibration solution used must have been selected during parameter setting.
- Calibration accuracy decisively depends on the exact detection of the calibration solution's temperature. Using the measured or entered temperature, the Protos determines the nominal value for the calibration solution from a stored table.
- Observe response time of temperature probe!
- For exact determination of the cell constant, wait until the temperature probe and calibration solution have the same temperature.

Be sure to observe during calibration:

- If the measured conductance or the measured temperature fluctuate greatly, the calibration procedure is aborted after 2 min.
- If an error message appears, you have to repeat calibration.

Adjustment: Taking over the values determined by calibration

- When the values determined by calibration are correct, they must be taken over to adjust the analyzer.

Note: The display may vary depending on the device version.

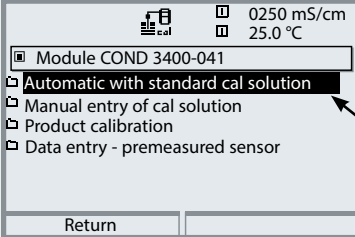
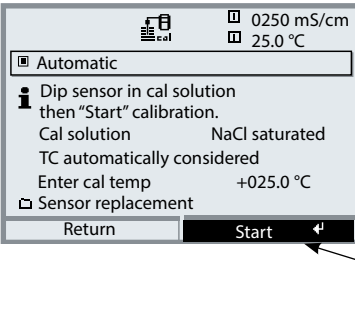
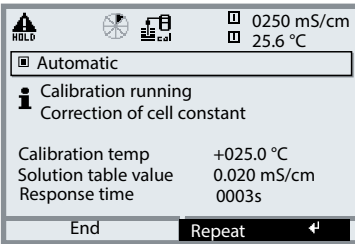
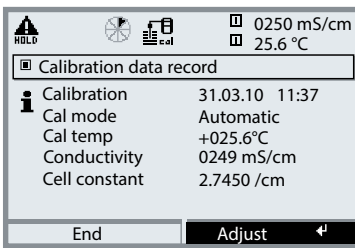
Menu	Display	Action
		<p>Select calibration menu Select "Module COND"</p> <p>Select calibration method: "Automatic with standard cal solution", confirm with enter.</p>
		<p>Display of selected calibration solution.</p> <p>Enter process temperature, if manual temperature adjustment has been selected.</p> <p>Dip sensor in calibration solution.</p> <p>Start calibration with softkey or enter.</p>
		<p>Calibration is running.</p> <p>The display shows:</p> <ul style="list-style-type: none"> • Calibration temperature • Solution table value (conductivity in dependence on cal temperature) • Response time
		<p>Adjustment</p> <p>Press "Adjust" to take over the values determined during calibration for calculating the measured variables.</p>

Calibration / Adjustment

Manual Entry of Calibration Solution

Manual Entry of Calibration Solution

For calibration with manual entry of the calibration solution's conductivity, the sensor is immersed in a calibration solution. Protos determines a conductivity/calibration temperature value pair. Then, the temperature-corrected conductivity value of the solution must be entered. To do this, read off the conductivity for the temperature displayed from the TC table of the calibration solution. Intermediate conductivity values must be interpolated. Protos automatically calculates the cell constant.

During calibration the module is in function check (HOLD) mode.

Current outputs and relay contacts of the module behave as configured (Module BASE).

NOTICE!

- Use fresh calibration solutions only!
- Calibration accuracy decisively depends on the exact detection of the calibration solution's temperature.
- Observe response time of temperature probe!
- For exact determination of the cell constant, wait until the temperature probe and calibration solution have the same temperature.

Be sure to observe during calibration:

- If the measured conductance or the measured temperature fluctuate greatly, the calibration procedure is aborted after 2 min.
- If an error message appears, you have to repeat calibration.

Adjustment: Taking over the values determined by calibration

- When the values determined by calibration are correct, they must be taken over to adjust the analyzer.

Note: The display may vary depending on the device version.

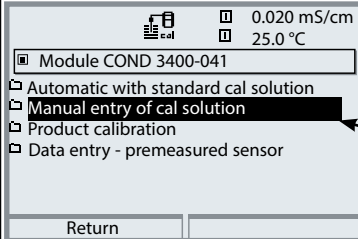
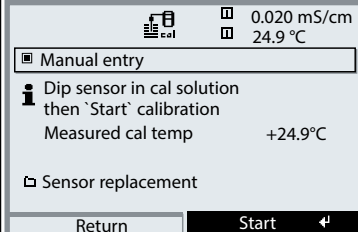
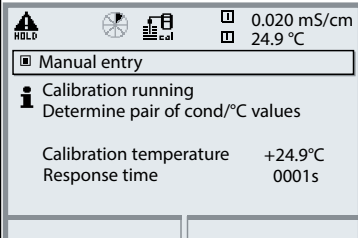
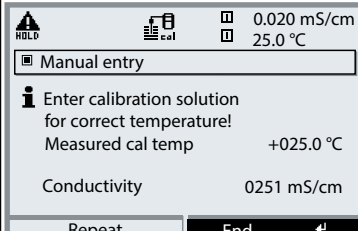
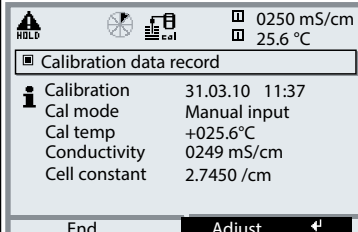
Menu	Display	Action
	 <p>0.020 mS/cm 25.0 °C</p> <p>Module COND 3400-041</p> <ul style="list-style-type: none"> Automatic with standard cal solution Manual entry of cal solution Product calibration Data entry - premeasured sensor <p>Return</p>	<p>Select calibration menu Select "Module COND"</p> <p>Select calibration method: "Manual entry of cal solution", confirm with enter.</p>
	 <p>0.020 mS/cm 24.9 °C</p> <p>Manual entry</p> <p>Dip sensor in cal solution then `Start` calibration Measured cal temp +24.9°C</p> <p>Sensor replacement</p> <p>Return Start</p>	<p>Enter process temperature, if manual temperature adjustment has been selected. Immerse sensor in cal solution. Start calibration with softkey or enter.</p>
	 <p>0.020 mS/cm 24.9 °C</p> <p>Manual entry</p> <p>Calibration running Determine pair of cond/°C values</p> <p>Calibration temperature +24.9°C Response time 0001s</p>	<p>Calibration is running. The display shows:</p> <ul style="list-style-type: none"> • Calibration temperature • Response time
	 <p>0.020 mS/cm 25.0 °C</p> <p>Manual entry</p> <p>Enter calibration solution for correct temperature! Measured cal temp +025.0 °C</p> <p>Conductivity 0251 mS/cm</p> <p>Repeat End</p>	<p>Enter conductivity. End calibration with softkey ("End").</p>
	 <p>0250 mS/cm 25.6 °C</p> <p>Calibration data record</p> <p>Calibration 31.03.10 11:37 Cal mode Manual input Cal temp +025.6°C Conductivity 0249 mS/cm Cell constant 2.7450 /cm</p> <p>End Adjust</p>	<p>Adjustment Press "Adjust" to take over the values determined during calibration for calculating the measured variables.</p>

Calibration / Adjustment

Product Calibration

Product Calibration (Calibration by Sampling)

When the sensor cannot be removed, e.g. for sterility reasons (for biotechnical processes), its cell constant can be determined with “sampling”.

To do so, the currently measured process value (conductivity or concentration¹⁾) is saved by the Protos.

Immediately afterwards, you take a sample from the process. The sample value should be measured at process conditions (same temperature!). The determined value is entered in the measuring system. From the difference between process value and sample value, the Protos calculates the cell constant of the conductivity sensor.

During calibration the module is in function check (HOLD) mode.

Current outputs and relay contacts of the module behave as configured (Module BASE).

Product calibration without TC correction (for conductivity)

Take a sample from the process. Measure its value at the temperature at which the sample has been taken (“Sample temp”, see display). To do so, it may be necessary to thermostat the sample correspondingly in the lab.

Temperature compensation must be turned off at the comparison meters (TC = 0 %/K).

Product calibration with TC correction Tref = 25 °C/77 °F (for conductivity)

Take a sample from the process. When measuring in the lab (TC linear), be sure that the same values are set for reference temperature and temperature coefficient in the comparison meter and in the Protos. Furthermore, the measuring temperature should correspond to the sample temperature (see display).

Transport the sample in an insulated container (Dewar).

NOTICE!

Product calibration can only be performed if the process medium is stable. That means, for example, that there are no chemical reactions which have an effect on the process conductivity. At higher temperatures, the sample values can also be invalidated due to evaporation.

Note: The display may vary depending on the device version.

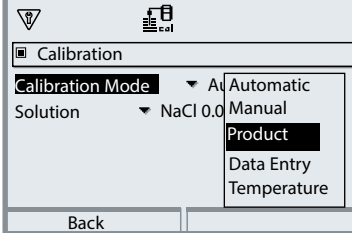
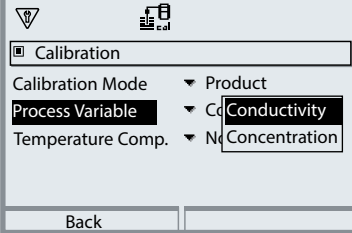
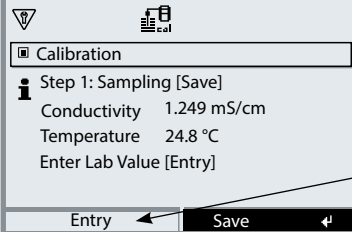
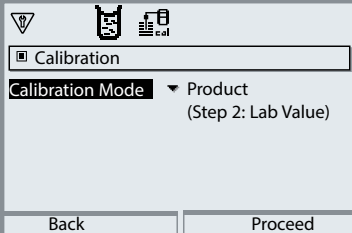
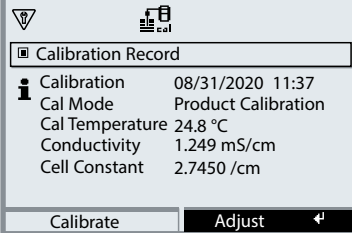
Menu	Display	Action
		<p>Select calibration. Select COND module. Select Calibration Mode > Product and press enter to confirm. Select Process Variable > Conductivity or Concentration¹⁾. Conductivity: calibration with/without temperature compensation Concentration: Select the medium.</p>
		<p>Step 1 Take sample. Store measured value and temperature at the moment of sampling ("Save" softkey or enter). The analyzer automatically returns to calibration mode selection. Press meas to return to measurement.</p>
		<p>Exception: Sample value can be determined and entered on site: Left softkey: "Input"</p>
		<p>Step 2 Lab value has been measured. Open the calibration menu again. Right softkey: "Input" Enter reference value ("Lab value"). Confirm with "OK" or repeat calibration.</p>
		<p>Adjustment Press "Adjust" softkey to take over the values determined during calibration for calculating the measured variables.</p>

1) with Protos II 4400(X) and add-on function FW4400-009

Calibration / Adjustment

Data Entry of Premeasured Sensors



Data Entry of Premeasured Sensors

Entry of cell constant and zero point of a sensor, related to 25 °C/77 °F, 1013 mbar.

During calibration the module is in function check (HOLD) mode.

Current outputs and relay contacts of the module behave as configured (Module BASE).

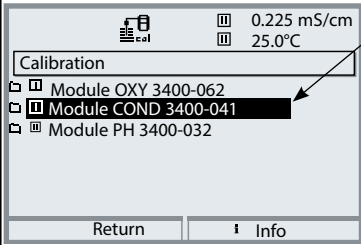
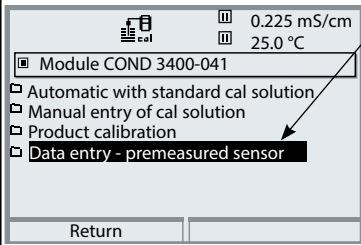
Note: The display may vary depending on the device version.

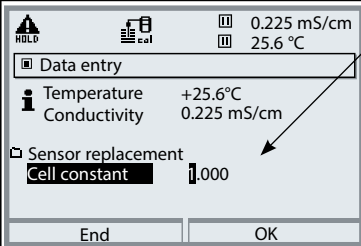
Menu	Display	Action
	 <p>0.225 mS/cm 25.0 °C</p> <p>Calibration</p> <ul style="list-style-type: none"> Module OXY 3400-062 Module COND 3400-041 Module PH 3400-032 <p>Return Info</p>	<p>Select module: COND</p> <p>During calibration, the output currents (1 and 2), limit contacts, and controller output are in HOLD mode.</p> <p>Confirm with enter</p>
	 <p>0.225 mS/cm 25.0 °C</p> <p>Module COND 3400-041</p> <ul style="list-style-type: none"> Automatic with standard cal solution Manual entry of cal solution Product calibration Data entry - premeasured sensor <p>Return</p>	<p>Select calibration method "Data entry"</p> <p>Confirm with enter</p>
	 <p>0.225 mS/cm 25.6 °C</p> <p>Data entry</p> <p>Temperature +25.6 °C Conductivity 0.225 mS/cm</p> <p>Sensor replacement Cell constant 1.000</p> <p>End OK</p>	<p>Enter the cell constant of a premeasured sensor. Confirm with "OK" or repeat calibration.</p> <p>With "Concentration" enabled, a concentration calibration can be performed by changing the cell constant value – NOTICE! The cell constant value is immediately changed in the memory, even if calibration is aborted by pressing meas.</p>

Calibration / Adjustment

Calibrating the Sensors

Sensor Calibration

Since the cell constant is subject to production-related variances, the dismantled sensor should be calibrated with a calibration solution (e.g. NaCl saturated). The cell constant of the sensor – particularly of a fringe-field sensor – depends on the type of installation:

- When the sensor is mounted in a free space (minimum distances exceeded), the cell constant can be entered directly as given in the specifications.
Calibration method: "Data entry"
- When mounted in restricted space (minimum distances not kept), the sensor must be calibrated when mounted since the resulting cell constant has changed. Calibration method: "Product calibration".

SE 630 Sensor

The SE 630 sensor can be calibrated automatically or manually. A suitable calibration solution is 0.01 mol/l NaCl, for example.

SE 604 Sensor

The SE 604 sensor must be calibrated with direct input of the cell constant since calibration solutions in the $\mu\text{S}/\text{cm}$ range are not stable.

Calibration / Adjustment

Temp Probe Adjustment

Note: With Protos II 4400(X) in the Calibration menu,
with Protos 3400(X) in the Maintenance menu.

Temp Probe Adjustment

This function allows compensating for the individual temperature probe tolerance and the influence of the lead resistances to increase the accuracy of temperature measurement. Make sure that the process temperature is precisely measured using a calibrated reference thermometer when performing an adjustment. The measurement error of the reference thermometer should be less than 0.1 °C. Adjustment without precise measurement might result in considerable deviations of the measured value display!

With Protos II 4400(X), the data from the last adjustment and the temperature offset can be called from the Diagnostics menu, see p. 60.

Parameter Setting

⚠ CAUTION! Incorrect parameter settings or adjustments can result in incorrect outputs.

The Protos II 4400(X) must therefore be commissioned by a system specialist, all its parameters must be set, and it must be fully adjusted.

NOTICE!

The "function check" (HOLD) mode is active during parameter setting. The behavior of the current outputs depends on the parameter setting, i.e., they may be frozen at the last measurement or set to a fixed value. The red "Alarm" LED blinks.

Measurement operations must not be carried out while the Protos is in the function check (HOLD) mode, as this may put the user at risk due to unexpected system behavior.

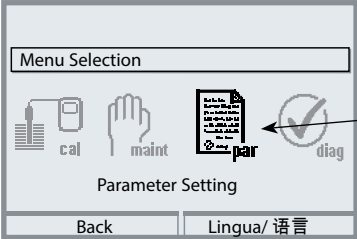
Menu	Display	Action
		<p>Open the Parameter Setting menu From the measuring mode: Press menu key to select menu. Select parameter setting using arrow keys, press enter to confirm</p>

Parameter Setting: Operating Levels

Viewing level, Operator level, Administrator level

Note: Function check (HOLD) mode active (Setting: BASE module)

Note: The display may vary depending on the device version.

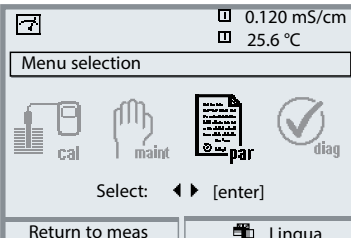
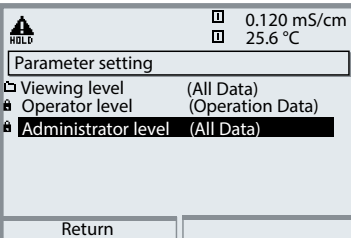
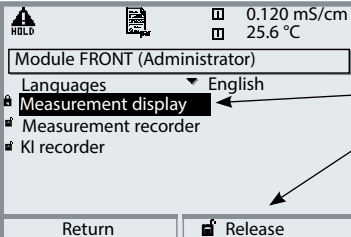
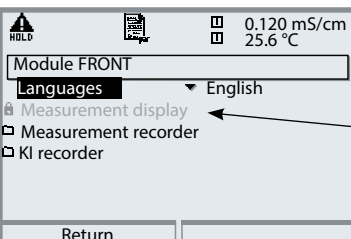

Menu	Display	Action
		<p>Open parameter setting</p> <p>From the measuring mode: Press menu key to select menu. Select parameter setting using arrow keys, press enter to confirm.</p>
		<p>Administrator level</p> <p>Access to all functions, also passcode setting. Releasing or blocking a function for access from the Operator level.</p>
		<p>Functions which can be blocked for the Operator level are marked with the "lock" symbol. The functions are released or blocked using the softkey.</p>
		<p>Operator level</p> <p>Access to all functions which have been released at the Administrator level. Blocked functions are displayed in gray and cannot be edited (Fig.).</p> <p>Viewing level</p> <p>Display of all settings. No editing possible!</p>

Parameter Setting: Locking a Function

Administrator level: Enabling/locking functions for Operator level

Note: Function check (HOLD) mode active (Setting: BASE module)

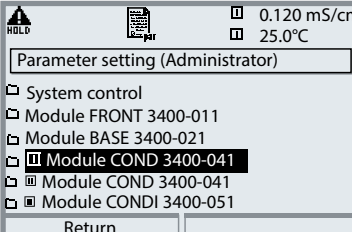
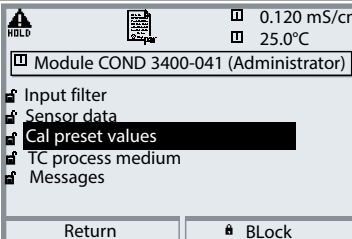
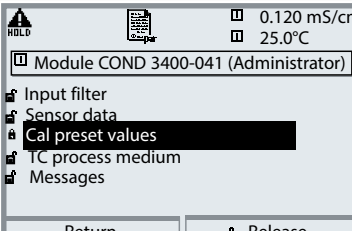
Note: The display may vary depending on the device version.

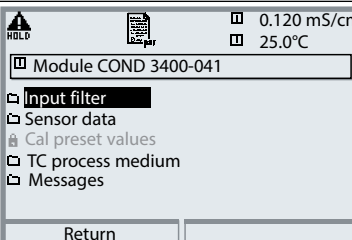
Menu	Display	Action
		<p>Example: Blocking access to the calibration adjustments from the Operator level</p> <p>Open parameter setting Select Administrator level. Enter passcode (1989). Select "Module COND" (e.g.) using arrow keys, press enter to confirm.</p>
		<p>Select "Cal preset values" using arrow keys. "Block" with softkey.</p>
		<p>Now, the "Cal preset values" line is marked with the "lock" icon. This function cannot be accessed from the Operator level any more. The softkey function changes to "Release".</p>
		<p>Open parameter setting Select <u>Operator level</u>, passcode (1246). Select "Module COND". Now, the locked function is displayed in gray and marked with the "lock" icon.</p>

Parameter Setting

Note: The display may vary depending on the device version.

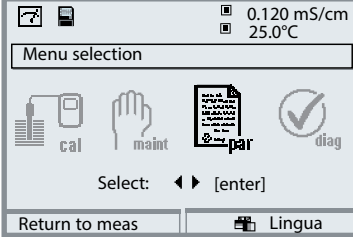
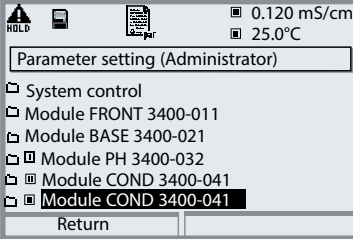
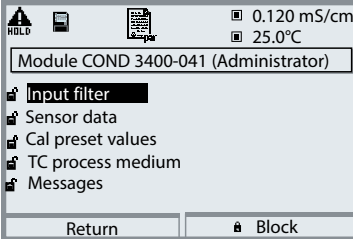
Menu	Display	Action
		<p>Activating parameter setting</p> <p>From the measuring mode: Press menu key to select menu. Select parameter setting using arrow keys, press enter to confirm. Passcode as delivered: 1989</p>
		<p>Select module, press enter to confirm.</p> <p>(In the Figure, the "Module COND" is selected, for example.)</p>
		<p>Select parameter using arrow keys, press enter to confirm.</p>

During parameter setting the analyzer is in function check (HOLD) mode:
 Current outputs and relay contacts behave as configured (BASE module).

Parameter Setting

Default Settings and Selection Range

Note: Function check (HOLD) mode active.

Parameter	Default	Selection / Range
Input filter <ul style="list-style-type: none"> • Pulse suppression 	Off	Off, On
Sensor data <ul style="list-style-type: none"> • Sensor type • Nominal cell constant • Temperature detection Measuring temp Cal temp • Sensocheck 	Other 2-EL sensor 1.0000 cm ⁻¹ Pt 1000 Auto Auto Off	Other 2-El sensor, Other 4-El sensor Sensor SE 600, Sensor SE 602, Sensor SE 603, Sensor SE 604, Sensor SE 610, Sensor SE 620, Sensor SE 630, X.XXXX (entry) depending on selected sensor Pt100, Pt1000, NTC30kohm, Ni100 (sensor selection) Auto, manual: Default +25.0 °C (entry) Auto, manual: Default +25.0 °C (entry) Off, Failure, Maint. request
Protos II 4400(X): Cal Presettings Calibration Mode Automatic: <ul style="list-style-type: none"> • Cal. Solution Product: <ul style="list-style-type: none"> • Conductivity • Concentration ¹⁾ Protos 3400(X): Cal preset values Calibration solution Product calibration	Automatic NaCl saturated Conductivity Without TC NaCl (0...26 %)	Automatic, Manual, Product, Data Entry, Temperature Automatic: Cal solution NaCl 0.01 mol/l, NaCl 0.1 mol/l, NaCl saturated, KCl 0.01 mol/l KCl 0.1 mol/l, KCl 1 mol/l Conductivity, Concentration ¹⁾ With/Without TC Medium, see p. 39
TC process medium <ul style="list-style-type: none"> • TC correction • Reference temp • Impurity 	Off	Off, linear, EN 27888, ultrapure water (Linear: Enter reference temp +025.0 °C) (Ultrapure water: NaOH, NaCl, HCl, NH ₃) (Adjustment range depending on parameter)

1) with add-on function FW4400-009

2) with add-on function SW3400-008/FW4400-008

Parameter Setting

TC Process Medium

Note: Function check (HOLD) mode active.

Note: The display may vary depending on the device version.

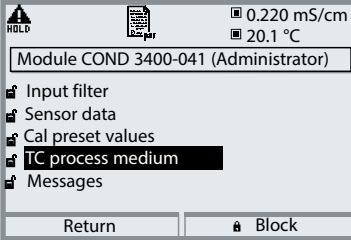
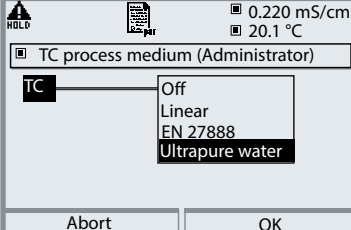
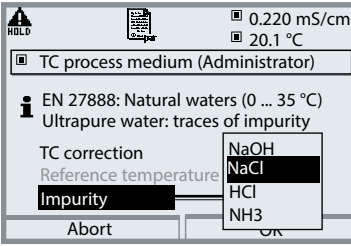
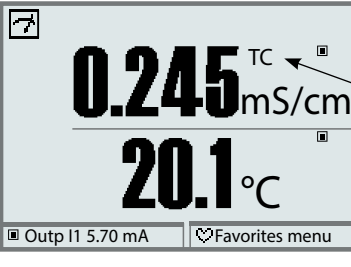
Menu	Display	Action
		<p>TC process medium</p> <p>You can choose from:</p> <ul style="list-style-type: none"> • Linear (input of TC coefficient) • EN 27888 • Ultrapure water (add-on function SW3400-008 / FW4400-008)
		<p>When you have selected “Ultrapure water”, you must specify the type of impurity:</p> <p>NaOH Alkaline ultrapure water</p> <p>NaCl Neutral ultrapure water, for conductivity measurement in water processing behind gravel bed filter</p>
		<p>HCl Acidic ultrapure water, for conductivity measurement behind cation filter</p> <p>NH₃ Ammoniacal ultrapure water</p>
		<p>When the TC correction for process medium is switched on, “TC” appears in the display in measuring mode.</p>

Parameter Setting: Concentration Curves

Default Settings and Selection Range (SW 3400-009 / FW4400-009)

Note: Function check (HOLD) mode active.

Parameter	Default	Selection / Range
Concentration (with add-on function SW3400-009/FW4400-009 only • Medium ("Yes" selected)	Off H_2SO_4 (0-30%)	On, Off NaCl (0-28 %), HCl (0-18 %), NaOH (0-24 %), H_2SO_4 (0-37 %), HNO_3 (0-30 %), H_2SO_4 (89-99 %), HCl (22-39 %), HNO_3 (35-96 %), H_2SO_4 (28-88 %), NaOH (15-50 %), Oleum (12-45%) Table
USP function • Reduced limit • Monitoring	Off 100 % Off	On, Off 10 % ... 100% Off, Failure, Maint. request

Note: The menus may vary depending on the device version.

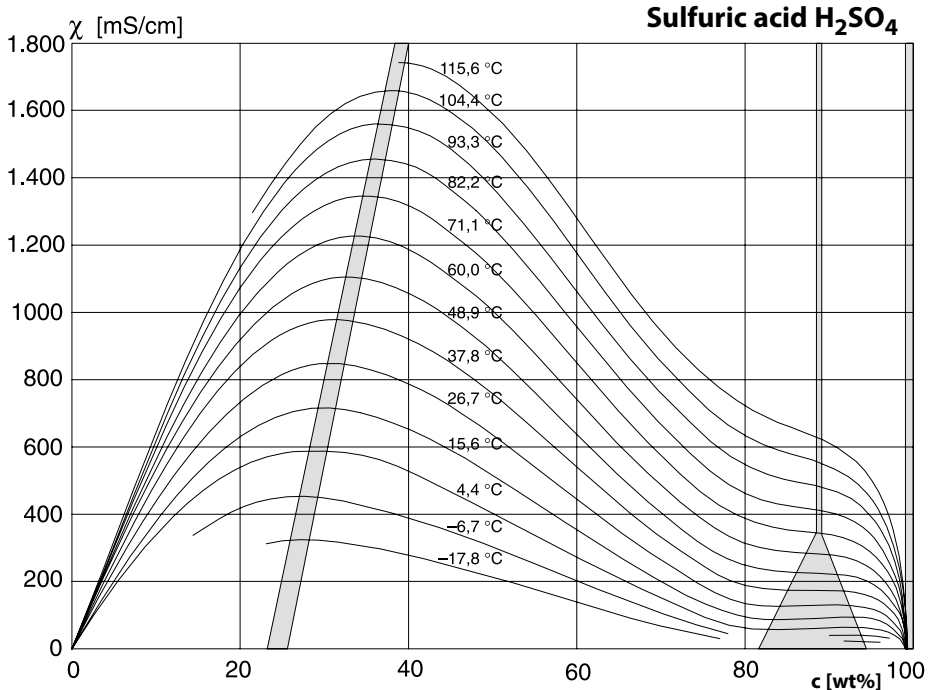

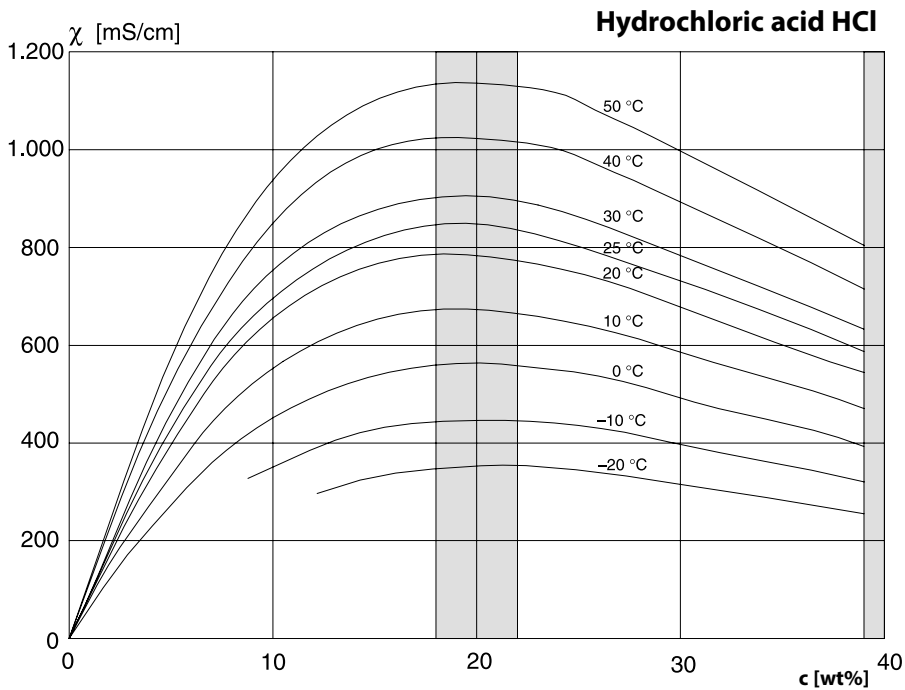
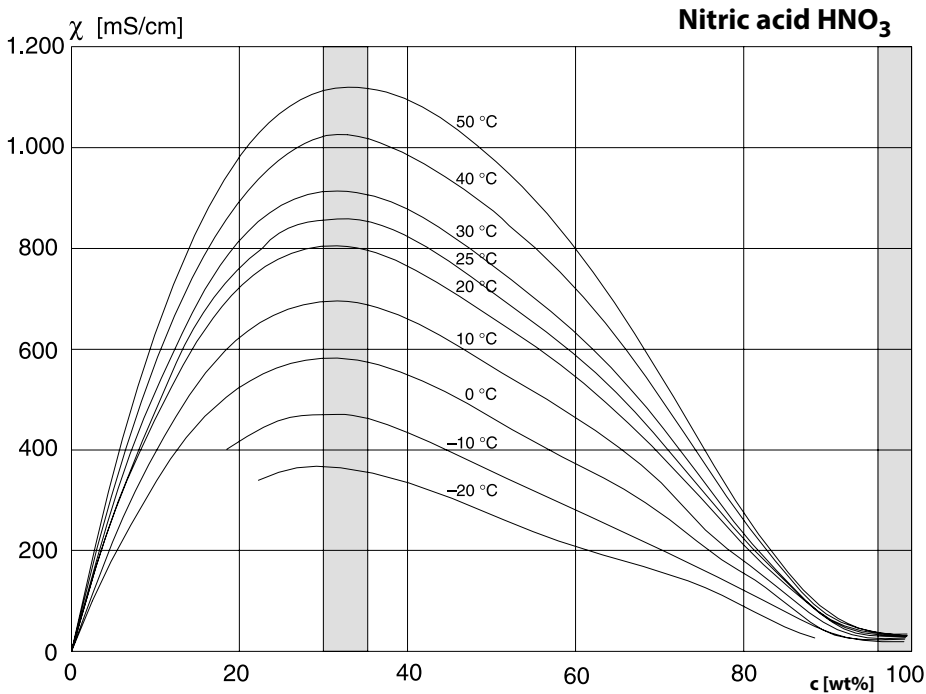

Sodium hydroxide solution NaOH

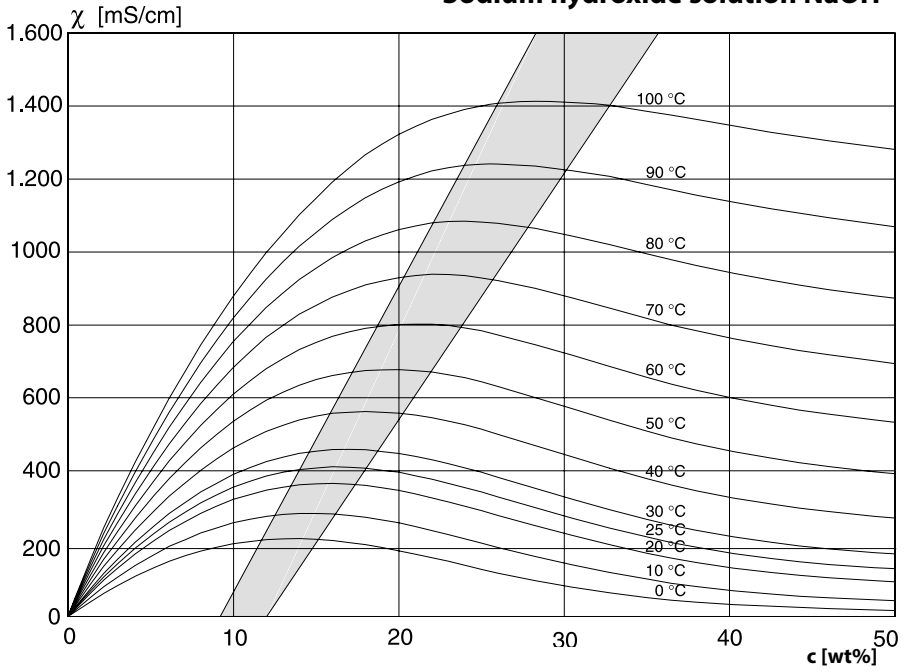
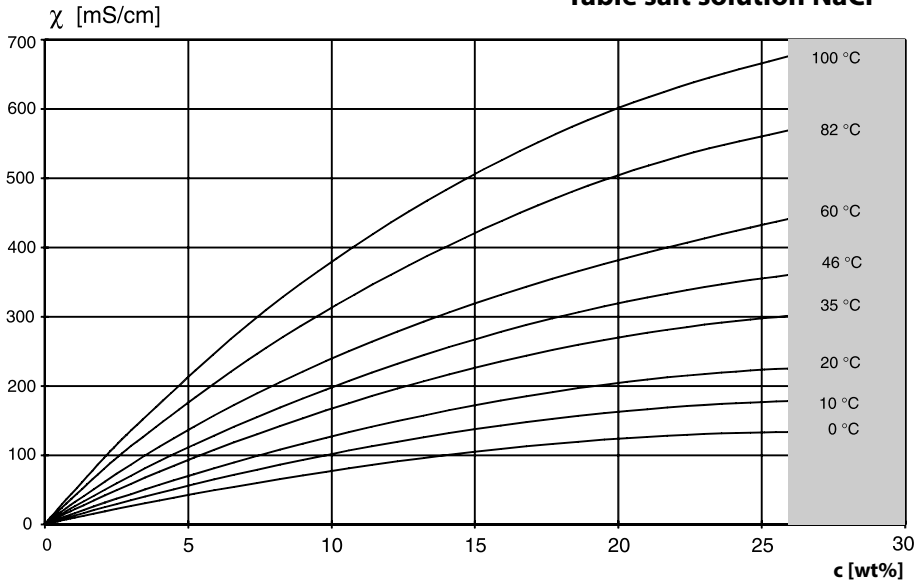
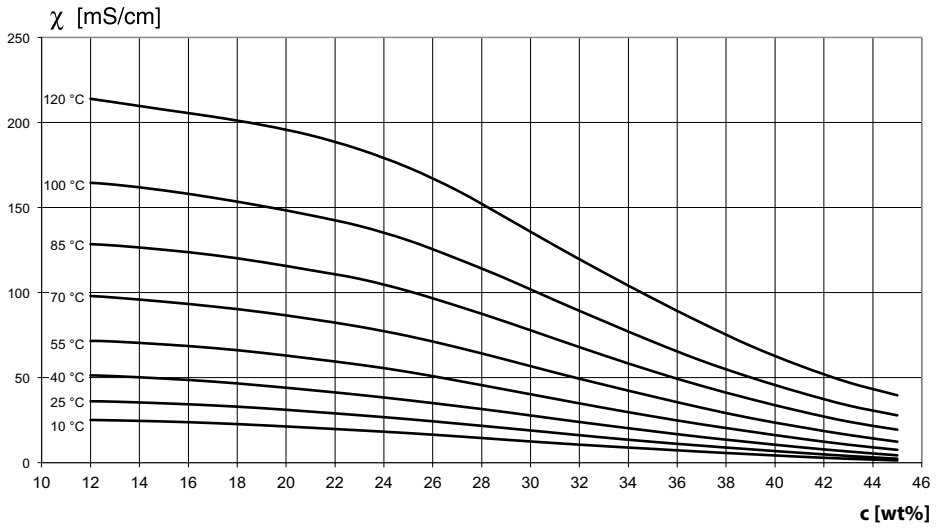

Table salt solution NaCl



Oleum $\text{H}_2\text{SO}_4 \cdot \text{SO}_3$



Concentration Table

Menu selection: Parameter setting > System control > Concentration table

Specifying a concentration solution for conductivity measurement

To specify the customer-specific solution, 5 concentration values A-E are entered in a matrix together with 5 temperature values 1-5. To do so, first enter the 5 temperature values, then enter the respective conductivity values for each concentration A-E.

These solutions will then be available in addition to the permanently stored standard solutions (select "Table").

Note: The display may vary depending on the device version.

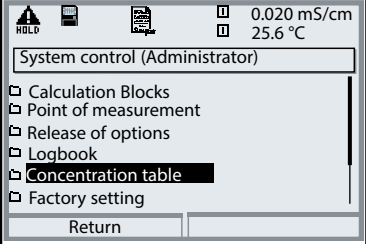
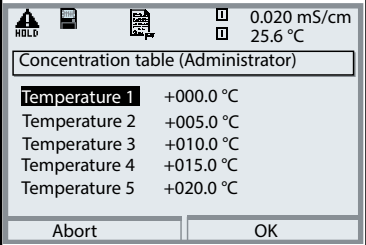
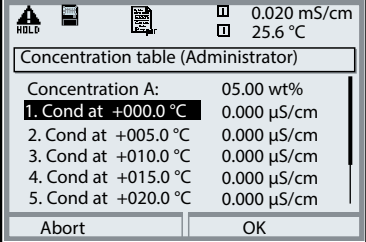
Menu	Display	Action
	 <p>System control (Administrator)</p> <ul style="list-style-type: none"> ▢ Calculation Blocks ▢ Point of measurement ▢ Release of options ▢ Logbook ▢ Concentration table ▢ Factory setting <p>Return</p>	<p>To enter values</p> <ul style="list-style-type: none"> • Open parameter setting • System control • Select "Concentration table"
	 <p>Concentration table (Administrator)</p> <p>Temperature 1 +000.0 °C Temperature 2 +005.0 °C Temperature 3 +010.0 °C Temperature 4 +015.0 °C Temperature 5 +020.0 °C</p> <p>Abort OK</p>	<p>Enter 5 temperature values (right/left arrow keys to select position, up/down arrow keys to edit number, confirm by pressing enter.)</p>
	 <p>Concentration table (Administrator)</p> <p>Concentration A: 05.00 wt% 1. Cond at +000.0 °C 0.000 µS/cm 2. Cond at +005.0 °C 0.000 µS/cm 3. Cond at +010.0 °C 0.000 µS/cm 4. Cond at +015.0 °C 0.000 µS/cm 5. Cond at +020.0 °C 0.000 µS/cm</p> <p>Abort OK</p>	<p>Enter values for concentrations A-E for the respective temperatures. The table values must be continuous. Maxima/minima are not permitted. Incorrect entries are marked with ✕.</p>

The concentration table is selected as follows:

Parameter Setting > COND Module > Cal Presettings:

Calibration Mode: Automatic, Cal Solution: Table.

USP Function

Monitoring of Ultrapure Water in the Pharmaceutical Industry
(To configure: Select Parameter setting COND module)

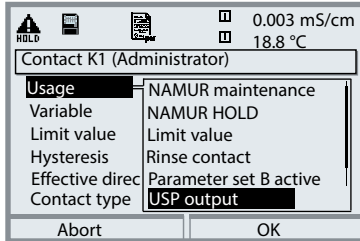

USP Function, Define Relay Output

When a COND module is installed, one of the floating relay outputs of the BASE module (K1, K2 or K3) can be assigned to the USP function.

- Select parameter setting:
- Administrator level (HOLD active!)
- Module BASE: Define contact "Usage"

The USP can be selected as USP% process variable for output (display, current output, limit value, measurement recorder)

According to the "USP" directive (U.S.Pharmacopeia), Appendix 5, Section 645 "Water Conductivity" the conductivity of pharmaceutical waters can be monitored online.

To do so, the conductivity is measured without temperature compensation and compared with limit values. The water is usable without further test steps when the conductivity is below the USP limit.

Reduced Limit:

The USP limit can be reduced down to 10 % (Parameter setting).

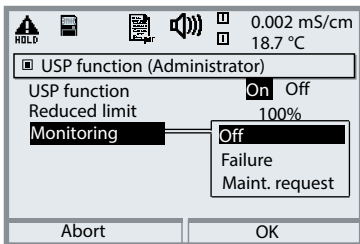

Select USP function

- Select parameter setting, then:
- Administrator level (HOLD active!)
- Module COND: USP function

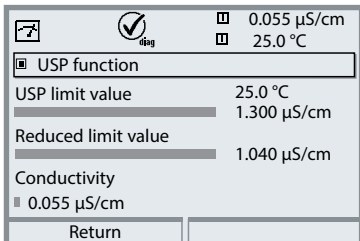

USP function: Diagnostics

- Select diagnostics:
- Module COND
- USP function: Display of USP limit, reduced limit, conductivity

Note: The display may vary depending on the device version.

Calculation Blocks

Menu selection: Parameter setting > System control > Calculation Blocks
Calculation of new variables from measured variables

Calculation Blocks

Two measuring modules with all their measured values serve as input for the calculation block. In addition, the general device status (NAMUR signals) is taken into account. The difference between the existing values is calculated:

Current Outputs

All current outputs can be set to output the new process variables formed by the Calculation Blocks.

Measurement Display

All new process variables can be displayed as primary or as secondary value.

Controller

Controller functions are not supported.

Functionality of Measuring Module

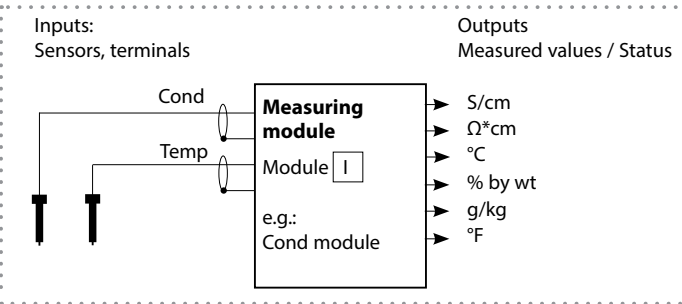

Functionality of Calculation Block

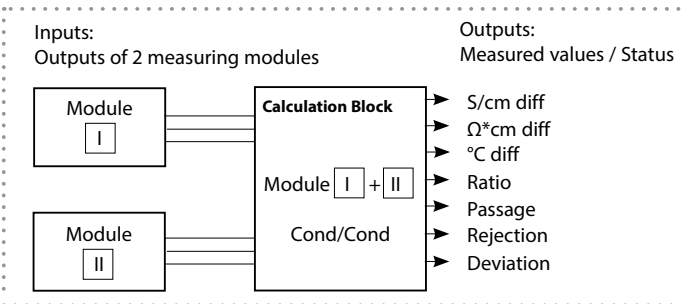

Activating a Calculation Block

Menu selection: Parameter setting > System control > Calculation Blocks

Combination of Measuring Modules

With three measuring modules the following Calculation Block combinations are possible:  +  ,  +  ,  + 

Two Calculation Blocks can be activated.

Note: The display may vary depending on the device version.

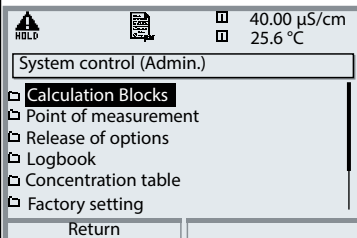
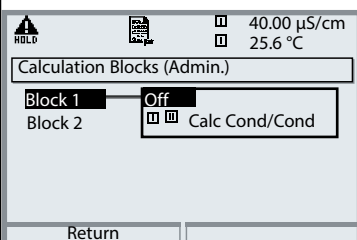
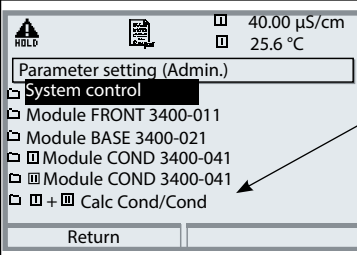
Menu	Display	Action
		Calculation Blocks <ul style="list-style-type: none"> • Open parameter setting • System control • Select "Calculation Blocks"
		<ul style="list-style-type: none"> • Depending on the modules installed, the possible combinations for Calculation Blocks are offered.
		<p>During parameter setting the Calculation Blocks are displayed like modules.</p>

Configuring a Calculation Block

Menu selection: Parameter setting > System control > Calculation Blocks

Setting the process variable to be calculated

Note: The display may vary depending on the device version.

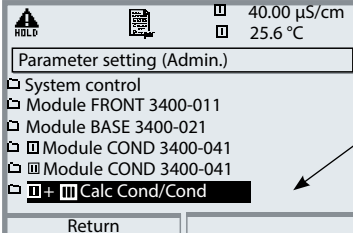
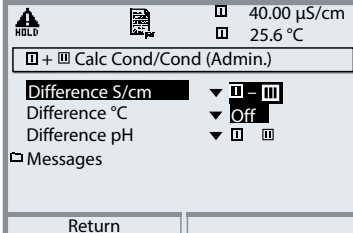
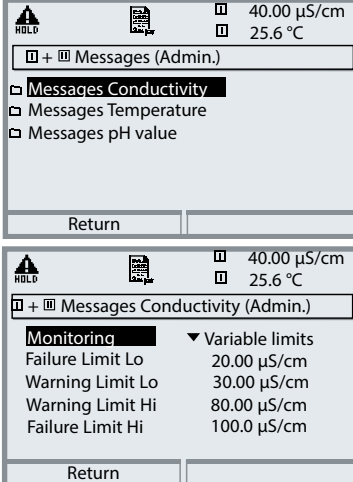
Menu	Display	Action
		<p>Select Calculation Block</p> <ul style="list-style-type: none"> • Open parameter setting • System control • Select module
		<p>Depending on the modules installed, the possible combinations for Calculation Blocks are offered.</p>
		<p>Messages</p> <p>You can activate messages for the selected variables.</p> <p>Variables which have been set as “Off” cannot be processed further.</p> <p>The measured values which shall release a message are set using the arrow keys (left/right: select position, up/down: edit number). Confirm by pressing enter.</p>

pH Value Calculation

Note: 2 conductivity modules required

pH Value Calculation by Means of Dual Conductivity Measurement

When monitoring boiler feed water in power plants, the pH value can be calculated by means of a dual conductivity measurement. For that purpose, the boiler feed water conductance is measured before and after the ion exchanger. This commonly used method of indirect pH value measurement does not require much maintenance and has the following advantage:

Normal pH measurement in ultrapure water is very critical. Boiler feed water does not contain many ions. This requires the use of a special electrode, which must be calibrated constantly and the service life of which is generally rather short.

Function

The conductivity before and after the ion exchanger is measured using two COND 3400-041 modules. From the two calculated conductivity values, a "Calculation Block" determines the concentration of sodium hydroxide solution and the pH value according to the calculation formulas shown below:

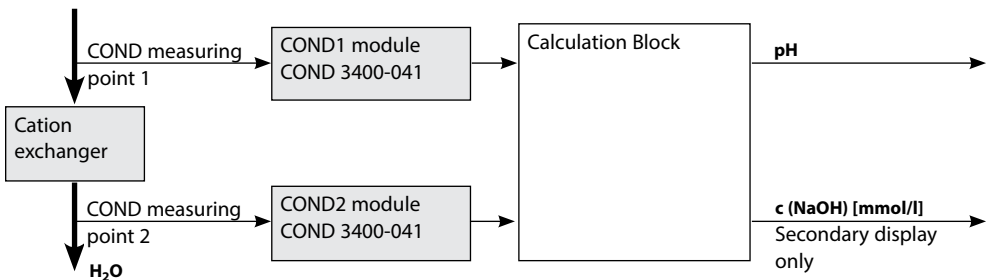

Calculating the Concentration of Sodium Hydroxide Solution / pH Value:

$$c(\text{NaOH}) = \frac{\text{COND1} - 1/3 \text{COND2}}{243}$$

$$\text{pH} = 11 + \log[c(\text{NaOH})]$$

Recommended pH Ranges:

10 ± 0.2 for < 136 bars operating overpressure or

9.5 ± 0.2 for > 136 bars operating overpressure

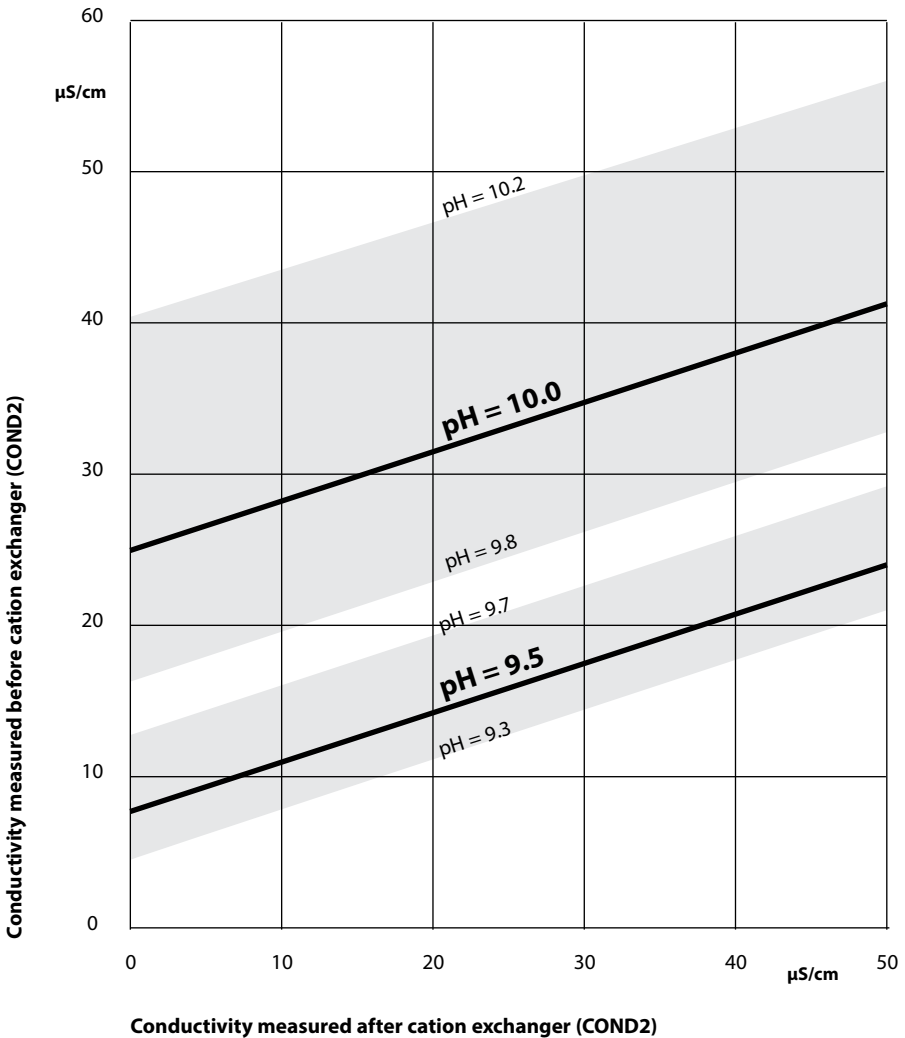

Figure:

Conditioning the feed water of natural circulation boilers with sodium hydroxide. Relationship between the pH value and the conductivity measured before and after the cation exchanger.

Source: Appendix to VGB guideline for boiler feed water, boiler water, and steam of steam generators above 68 bars permissible operating overpressure (VGB-R 450 L, edition 1988)

Parameter Setting

Parameter setting > System control

Note: Function check (HOLD) mode active

Note: The display may vary depending on the device version.

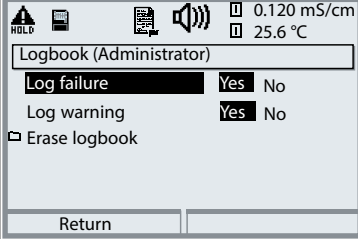
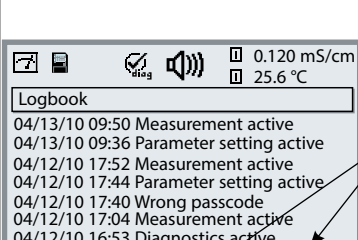
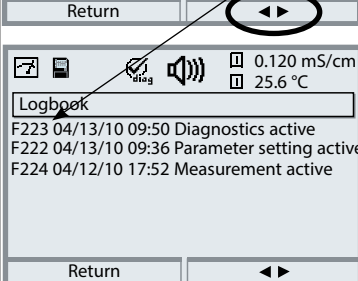
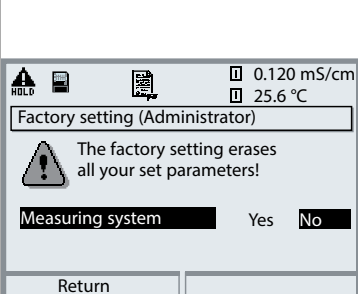
Menu	Display	Action
		<p>Logbook</p> <p>Select which messages are to be recorded in the logbook.</p> <p>The logbook directly displays the last events with date and time, e.g. calibrations, warning and failure messages, power failure (Protos 3400(X): 50, Protos II 4400(X): 100 events).</p>
		<p>The logbook entries can be called from the Diagnostics menu (Fig.). Pressing the right softkey displays the message identifier.</p>
		<p>SW3400-104: Extended logbook / FW4400-104: Logbook</p> <p>With SmartMedia Card and Protos 3400(X) or Data Card and Protos II 4400(X), max. 50,000 entries (Protos 3400(X)) or min. 20,000 entries (Protos II 4400(X)) can be saved on a memory card.</p>
		<p>Restore Factory Settings</p> <p>Allows resetting the parameters to their factory setting.</p>

Parameter Setting

Parameter Setting > COND Module > Messages: Default settings and selection range

Note: Function check (HOLD) mode active

Note: The menus may vary depending on the device version

Parameter	Default	Selection / Range
Messages <ul style="list-style-type: none"> • Conductivity • Resistivity • Concentration • Temperature • Salinity 	Limits max Off Off Off Off	Off, device limits max., variable limits* Off, device limits max., variable limits* Off, device limits max., variable limits* Off, device limits max., variable limits* Off, device limits max., variable limits*
		* With "Variable limits" selected, the following parameters can be edited: <ul style="list-style-type: none"> • Failure Limit Lo • Warning Limit Lo • Warning Limit Hi • Failure Limit Hi

Device limits

- Max. device limits: Maximum measuring range of device
- Variable limits: Range limits specified

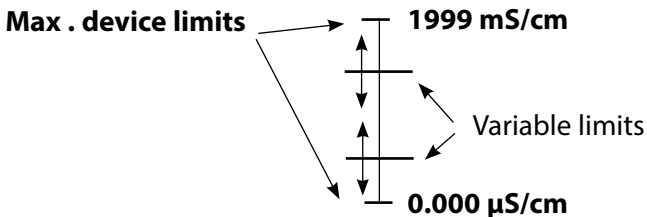





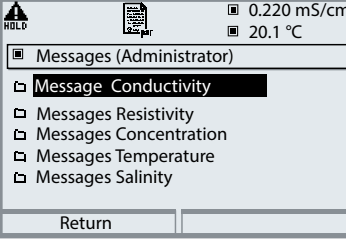

Parameter Setting

Parameter Setting > COND Module > Messages

Note: Function check (HOLD) mode active

Note: The display may vary depending on the device version.

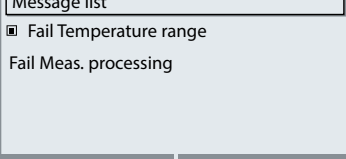
Menu	Display	Action
	 <p>Messages (Administrator)</p> <ul style="list-style-type: none"> Message Conductivity Messages Resistivity Messages Concentration Messages Temperature Messages Salinity <p>Return</p>	<p>Messages</p> <p>All parameters determined by the measuring module can generate messages.</p> <ul style="list-style-type: none"> Device limits max: Messages are generated when the process variable (e.g. conductivity) is outside the measurement range. The "Failure" icon is displayed, the NAMUR failure contact is activated (BASE module, factory setting: contact K4, N/C contact). The current outputs can signal a 22 mA message (user defined). Variable limits: For the "failure" and "warning" messages you can define upper and lower limits for message generation. Message icons:  Failure (Failure limit HiHi/LoLo)  Maintenance (Warning limit Hi/Lo)
	 <p>Messages Conductivity (Administrator)</p> <p>Monitoring Off</p> <p>Device limits max.</p> <p>Variable limits</p> <p>Abort OK</p>  <p>Messages (Administrator)</p> <p>Monitoring Variable limits</p> <p>Failure Limit Lo -0.000 μS/cm</p> <p>Warning Limit Lo -0.000 μS/cm</p> <p>Warning Limit Hi +1999 mS/cm</p> <p>Failure Limit Hi +1999 mS/cm</p> <p>Abort OK</p>  <p>Message list</p> <ul style="list-style-type: none"> Fail Temperature range Fail Meas. processing <p>Abort</p>	<p>Diagnostics menu</p> <p>When the "Maintenance" or "Failure" icons are flashing in the display, you should open the Diagnostics menu. The messages are displayed in the "Message list".</p>

Parameter Setting: BASE Module

Menu selection: Parameter Setting > BASE Module

Note: Function check (HOLD) active

Note: The display may vary depending on the device version.

Menu	Display	Action
		<p>Configuring the Current Output</p> <ul style="list-style-type: none"> • Open parameter setting • Enter passcode • Select "Module BASE" • Select "Output current ..."
		<ul style="list-style-type: none"> • Select process variable
		<p>Select Curve, e.g. "Linear": The measured variable is represented by a linear output current curve. The desired range of the measured variable is specified by the values for "Start" and "End". See also: "Minimum span"</p>

Assignment of Measured Values: Start (4 mA) and End (20 mA)

Example 1:
Range 0 ... 1999 mS/cm

Example 2: Range 500 ... 700 mS/cm
Advantage: Higher resolution in range of interest

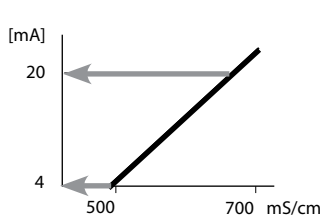
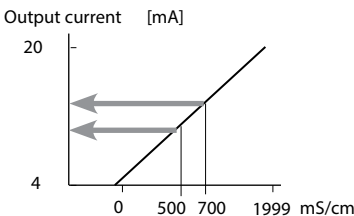

Current Outputs: Characteristics

Menu selection: Parameter setting > BASE module

Note: Function check (HOLD) mode active

- **Linear characteristic**

The process variable is represented by a linear output current curve.

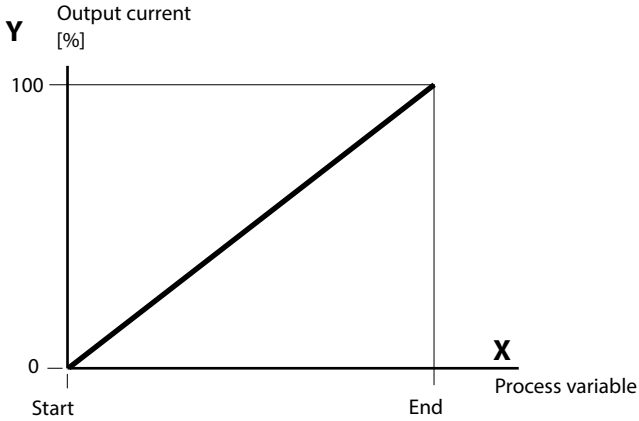

- **Trilinear characteristic**

Two additional vertices must be entered:

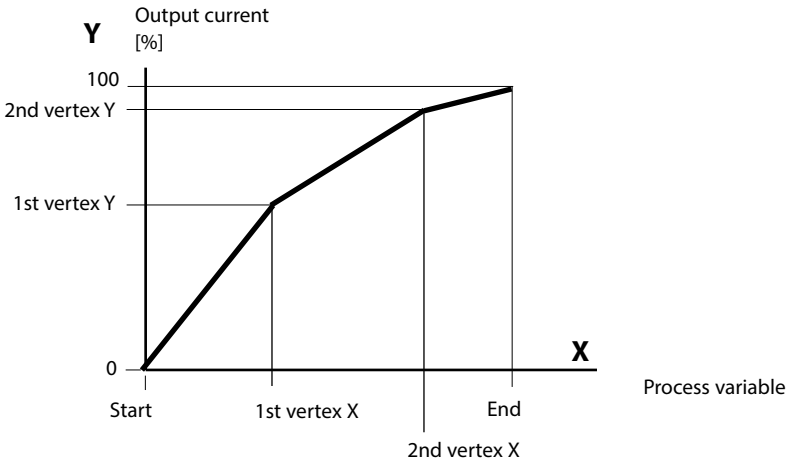

- **Note: Bilinear characteristic**

For a bilinear characteristic, identical parameters are entered for the two vertices (1st vertex, 2nd vertex).

• Function characteristic

Nonlinear output current characteristic: allows measurements over several decades, e.g. measuring very low values with a high resolution and high values with a low resolution.

Required: Entering a value for 50 % output current.

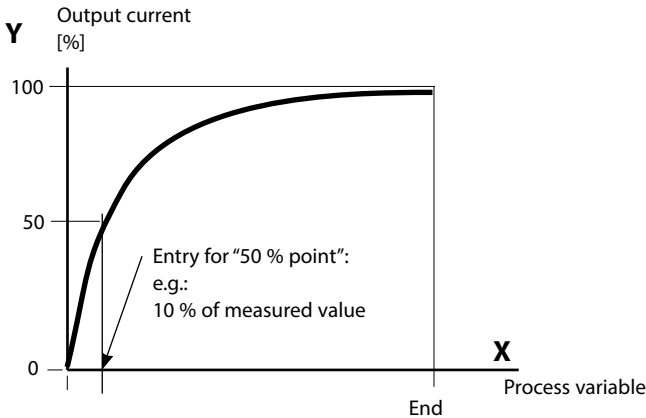

Equation

$$\text{Output current (4 to 20 mA)} = \frac{(1+K)x}{1+Kx} 16 \text{ mA} + 4 \text{ mA}$$

$$K = \frac{E + S - 2 * X50\%}{X50\% - S} \qquad x = \frac{M - S}{E - S}$$

- S: Start value at 4 mA
- X50%: 50% value at 12 mA (output current range 4 to 20 mA)
- E: End value at 20 mA
- M: Measured value

Logarithmic output curve over one decade:

- S: 10 % of maximum value
- X50%: 31.6 % of maximum value
- E: Maximum value

Logarithmic output curve over two decades:

- S: 1 % of maximum value
- X50%: 10 % of maximum value
- E: Maximum value

Current Outputs: Output Filter

Parameter setting > BASE module > Output current I... > Output filter

Note: Function check (HOLD) mode active

Time Averaging Filter

To smoothen the current output, a low-pass filter with adjustable time interval can be switched on. When there is a jump at the input (100 %), the output level is at 63 % after the time interval has been reached.

The time interval can be set from 0 to 120 sec. If the time interval is set to 0 sec, the current output follows the input.

Note:

The filter only acts on the current output and the current value of the secondary display, not on the measurement display, the limit values or the controller!

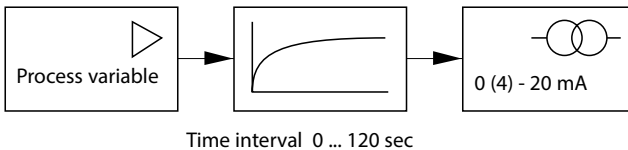

Note:

For further BASE module settings (behavior during messages, contacts, opto-coupler inputs) refer to the user manual of the basic device.

Maintenance

Sensor monitor, temp probe adjustment

Note: Function check (HOLD) mode active

Note: The display may vary depending on the device version.

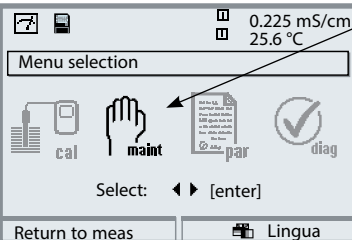
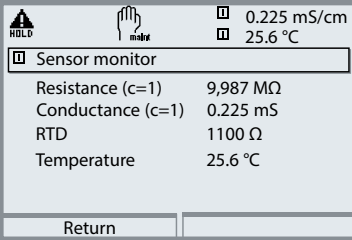
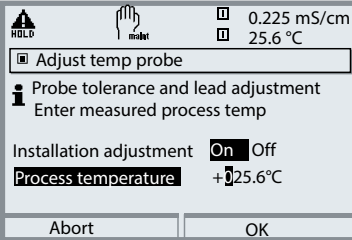
Menu	Display	Action
	  	<p>Open Maintenance</p> <p>From the measuring mode: Press menu key to select menu. Select maintenance using arrow keys, confirm by pressing enter. Passcode 2958 (The passcode can be edited by the administrator.) Then select COND module.</p> <p>Sensor Monitor</p> <p>During maintenance, the sensor monitor allows validation of the sensor by immersing it in a known solution, for example, and checking the values measured.</p> <p>Temp Probe Adjustment ¹⁾</p> <p>This function allows compensating for the individual temperature probe tolerance and the influence of the lead resistances to increase the accuracy of temperature measurement. Make sure that the process temperature is precisely measured using a calibrated reference thermometer when performing an adjustment! The measurement error of the reference thermometer should be less than 0.1 °C. Adjustment without precise measurement might result in considerable deviations of the measured value display!</p>



1) With Protos II 4400(X) in the Calibration menu

Diagnostic Functions

General status information of the measuring system

Select menu: Diagnostics

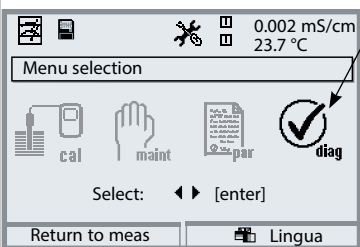
Note: The display may vary depending on the device version.

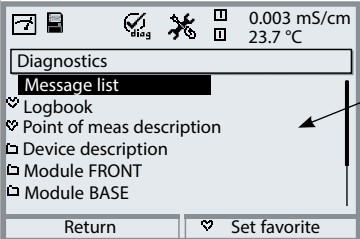
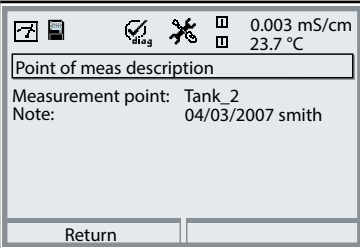
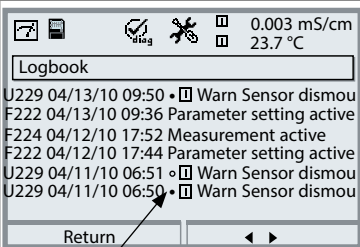
Menu	Display	Action
		<p>Opening the Diagnostics Menu</p> <p>From the measuring mode: Press menu key to select menu. Select diagnostics using arrow keys, confirm by pressing enter.</p>
		<p>The "Diagnostics" menu gives an overview of all functions available. Functions which have been set as "Favorite" can be directly accessed from the measuring mode.</p>
		<p>Point of Meas Description</p> <p>Allows entering a tag number and a note. Select position: left/right arrow key, select character: up/down arrow key. Confirm the entry by pressing enter.</p>
	 <p> <input type="checkbox"/> Releasing module: <ul style="list-style-type: none"> • Message activated ◦ Message deactivated </p>	<p>Logbook</p> <p>Shows the last events¹⁾ with date and time, e.g. calibrations, warning and failure messages, power failure. This permits quality management documentation to ISO 9001. (For parameter setting, see p. 50)</p>

1) Protos 3400(X): 50 events, Protos II 4400(X): 100 events

Diagnostic Functions

Menu selection: Diagnostics > COND ... Module
 Module diagnostics, sensor monitor, cal record

Note: The display may vary depending on the device version.

Menu	Display	Action
		<p>Opening the diagnostics menu</p> <p>From the measuring mode: Press menu key to select menu. Select diagnostics using arrow keys, confirm by pressing enter. Then select "Module COND".</p>
		<p>The Diagnostics menu gives an overview of all diagnostic functions available. <u>Messages</u> set as "Favorite" can be called up directly from the measuring mode using a softkey.</p> <p>To configure: Parameter setting > System control > Function control matrix.</p>
		<p>Module Diagnostics</p> <p>Internal function test (without Fig.).</p> <p>Sensor Monitor</p> <p>Shows the values currently measured by the sensor. Important function for diagnostics and validation! (cf Maintenance)</p>
		<p>Calibration/Adjustment Record</p> <p>Data of the last adjustment/calibration</p> <p>Temp. Offset Log</p> <p>Shows the data from the last temperature adjustment performed on the currently connected sensor.¹⁾</p>

Diagnostic Functions

Device description, FRONT module, BASE module

Note: The display may vary depending on the device version.

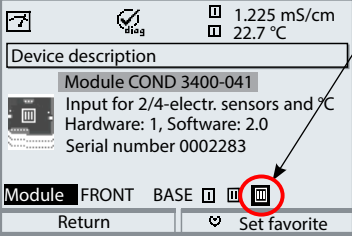
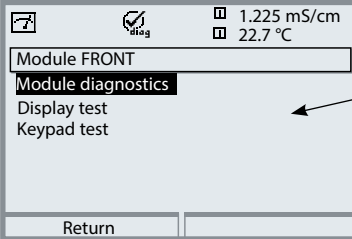
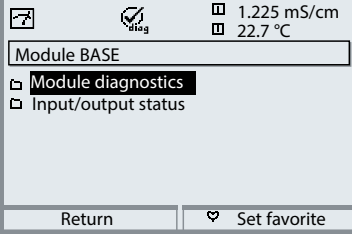
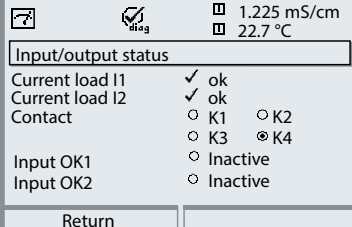
Menu	Display	Action
		<p>Device Description</p> <p>Select module using arrow keys: Provides information about all modules installed: Function, serial number, hardware and firmware version and device options.</p>
		<p>FRONT Module</p> <p>The module contains the display and keypad control.</p> <p>Test possibilities:</p> <ul style="list-style-type: none"> • Module diagnostics • Display test • Keypad test
	 	<p>BASE Module</p> <p>The module generates the standard output signals.</p> <p>Test possibilities:</p> <ul style="list-style-type: none"> • Module diagnostics • Input/output status <p>Example: Module BASE, input/output status.</p>

Setting Diagnostic Messages as Favorite

Menu selection: Parameter setting > System control > Function control matrix

Secondary displays (1)

Here, additional values are displayed in the measuring mode according to the factory setting. When the respective softkey (2) is pressed, the process variables measured by the modules plus date or time are displayed. In addition, you can use the **softkeys (2)** to control functions.

To assign a function to a softkey, select

Parameter setting > System control > Function control matrix

Function which can be controlled by softkeys:

- Parameter set selection
- KI recorder Start/Stop¹⁾
- Favorites
- Unical (fully automated probe controller)¹⁾

Favorites

Selected Diagnostic functions can be called directly from the measuring mode using a softkey.

The table on the next page explains how to select favorites.

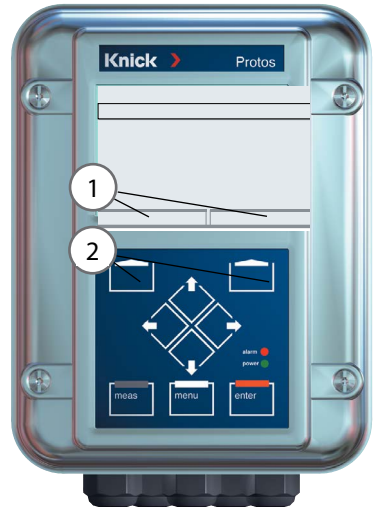

			0245 mS/cm	
			25.6 °C	
Function control matrix (Administrator)				
	ParSet	KI rec.	♥Fav	Unical
Input OK2	<input type="radio"/>	<input type="radio"/>	<input type="radio"/>	<input type="radio"/>
Left softkey	<input type="radio"/>	<input type="radio"/>	<input type="radio"/>	<input type="radio"/>
Right softkey	<input type="radio"/>	<input type="radio"/>	<input checked="" type="radio"/>	<input type="radio"/>
Profibus DO 2	<input type="radio"/>	<input type="radio"/>	<input type="radio"/>	<input type="radio"/>
Return		Connect		

Example:

“Favorites” to be selected with “Right softkey”

To select a softkey function:





Select desired function using arrow keys, press “Connect” softkey and confirm with **enter**.

To deselect a function:

Press “Disconnect” softkey, confirm with **enter**.

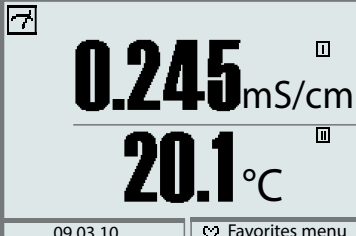
1) with Protos 3400(X)

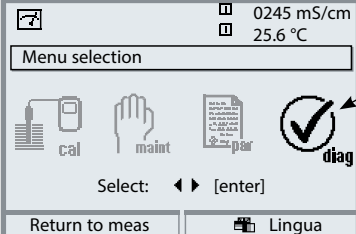
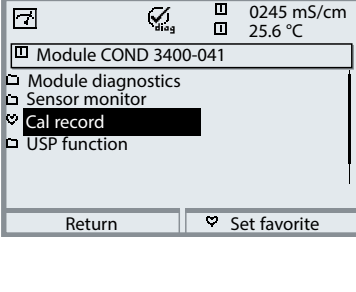
Note: The display may vary depending on the device version.

Menu	Display	Action
		<p>Favorites menu Diagnostic functions can be called directly from the measuring mode using a softkey. The “Favorites” are selected in the Diagnostics menu.</p>
		<p>Select favorites Press menu key to select menu. Select diagnostics using arrow keys, confirm with enter. Then select module and confirm with enter.</p>
		<p>Set/delete favorite: “Set favorite” allows activation of the selected diagnostic function directly from the measuring mode via softkey. The menu line is marked with a heart icon.</p>
		<p>Pressing the meas key returns to measurement. When the softkey has been assigned to “Favorites”, “Favorites menu” is read in the secondary display (see “Function control matrix”).</p>

Note:

When one of the softkeys has been assigned to the “Favorites menu” function, diagnostic functions which have been set as “Favorite” can be directly called from the measuring mode.

Diagnostic Functions

General status information of the measuring system

Menu selection: Diagnostics > Message list

Note: The display may vary depending on the device version.

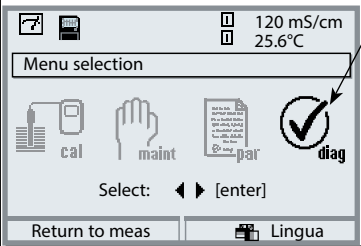
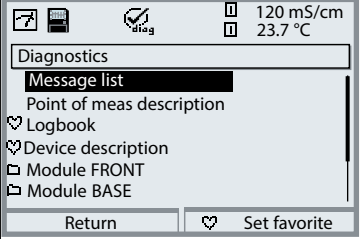
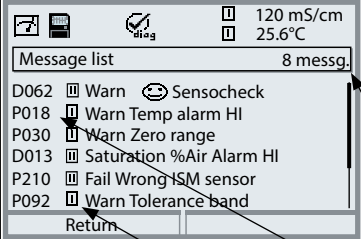
Menu	Display	Action
		<p>Opening the diagnostics menu</p> <p>From the measuring mode: Press menu key to select menu. Select diagnostics using arrow keys, confirm by pressing enter.</p>
		<p>The “Diagnostics” menu gives an overview of all functions available. Functions which have been set as “Favorite” can be directly accessed from the measuring mode.</p>
		<p>Message list</p> <p>Shows the currently activated warning or failure messages in plain text.</p> <p>Number of messages</p> <p>When there are more than 7 messages, a vertical scrollbar appears. Scroll with the up/down arrow keys.</p> <p>Message identifier</p> <p>See message list for description.</p> <p>Module identifier</p> <p>Specifies the module that has generated the message.</p>

Messages

Messages for COND 3400(X)-041 Module with Protos 3400(X)

No.	COND messages	Message type
C008	Meas. processing (factory settings)	FAIL
C009	Module failure (Firmware Flash check sum)	FAIL
C010	Conductivity range	FAIL
C011	Conductivity Alarm LO_LO	FAIL
C012	Conductivity Alarm LO	WARN
C013	Conductivity Alarm HI	WARN
C014	Conductivity Alarm HI_HI	FAIL
C015	Temperature range	FAIL
C016	Temperature Alarm LO_LO	FAIL
C017	Temperature Alarm LO	WARN
C018	Temperature Alarm HI	WARN
C019	Temperature Alarm HI_HI	FAIL
C020	Resistivity range	FAIL
C021	Resistivity Alarm LO_LO	FAIL
C022	Resistivity Alarm LO	WARN
C023	Resistivity Alarm HI	WARN
C024	Resistivity Alarm HI_HI	FAIL
C025	Concentration range	FAIL
C026	Concentration Alarm LO_LO	FAIL
C027	Concentration Alarm LO	WARN
C028	Concentration Alarm HI	WARN
C029	Concentration Alarm HI_HI	FAIL
C035	Cell constant range	WARN
C040	Salinity range	FAIL
C041	Salinity Alarm LO_LO	FAIL
C042	Salinity Alarm LO	WARN
C043	Salinity Alarm HI	WARN

Messages

No.	COND messages	Message type
C044	Salinity Alarm HI_HI	FAIL
C045	Conductance range	FAIL
C050	man. Temperature range	FAIL
C060	SAD SENSOFACE: Polarization	User-defined
C061	SAD SENSOFACE: Cable	User-defined
C090	USP limit value	User-defined
C200	Reference temperature	WARN
C201	TC correction	WARN
C202	TC range	WARN
C203	TC range	FAIL
C204	Cal: Sensor unstable	Text
C205	Cal: Sensor failure	Text
C254	Module reset	Text

No.	Calculation Block COND/COND messages	Message type
E010	Conductivity-Diff Range	FAIL
E011	Conductivity-Diff Alarm LO_LO	FAIL
E012	Conductivity-Diff Alarm LO	WARN
E013	Conductivity-Diff Alarm HI	WARN
E014	Conductivity-Diff Alarm HI_HI	FAIL
E015	Temperature-Diff Range	FAIL
E016	Temperature-Diff Alarm LO_LO	FAIL
E017	Temperature-Diff Alarm LO	WARN
E018	Temperature-Diff Alarm HI	WARN
E019	Temperature-Diff Alarm HI_HI	FAIL

Messages

No.	Calculation Block COND/COND messages	Message type
E020	Resistivity-Diff range	FAIL
E021	Resistivity-Diff Alarm LO_LO	FAIL
E022	Resistivity-Diff Alarm LO	WARN
E023	Resistivity-Diff Alarm HI	WARN
E024	Resistivity-Diff Alarm HI_HI	FAIL
E030	RATIO range	FAIL
E031	RATIO Alarm LO_LO	FAIL
E032	RATIO Alarm LO	WARN
E033	RATIO Alarm HI	WARN
E034	RATIO Alarm HI_HI	FAIL
E035	PASSAGE range	FAIL
E036	PASSAGE Alarm LO_LO	FAIL
E037	PASSAGE Alarm LO	WARN
E038	PASSAGE Alarm HI	WARN
E039	PASSAGE Alarm HI_HI	FAIL
E045	REJECTION range	FAIL
E046	REJECTION Alarm LO_LO	FAIL
E047	REJECTION Alarm LO	WARN
E048	REJECTION Alarm HI	WARN
E049	REJECTION Alarm HI_HI	FAIL
E050	DEVIATION range	FAIL
E051	DEVIATION Alarm LO_LO	FAIL
E052	DEVIATION Alarm LO	WARN
E053	DEVIATION Alarm HI	WARN
E054	DEVIATION Alarm HI_HI	FAIL
E055	c(NaOH) range	FAIL
E060	pH value range	FAIL
E061	pH value Alarm LO_LO	FAIL
E062	pH value Alarm LO	WARN
E063	pH value Alarm HI	WARN
E064	pH value Alarm HI_HI	FAIL

Messages

Messages for COND 3400(X)-041 Module with Protos II 4400(X)

 Failure
  Out of Specification
  Maintenance Required

No.	Message Type	COND Messages
C008	Failure	Meas. Processing (Factory Settings)
C009	Failure	Firmware Error
C010	Failure	Conductivity Range
C011	Failure	Conductivity Alarm LO_LO
C012	Out of Specification	Conductivity Alarm LO
C013	Out of Specification	Conductivity Alarm HI
C014	Failure	Conductivity Alarm LO_LO
C015	Failure	Temperature Range
C016	Failure	Temperature Alarm LO_LO
C017	Out of Specification	Temperature Alarm LO
C018	Out of Specification	Temperature Alarm HI
C019	Failure	Temperature Alarm HI_HI
C020	Failure	Resistivity Range
C021	Failure	Resistivity Alarm LO_LO
C022	Out of Specification	Resistivity Alarm LO
C023	Out of Specification	Resistivity Alarm HI
C024	Failure	Resistivity Alarm HI_HI
C025	Failure	Concentration Range
C026	Failure	Concentration Alarm LO_LO
C027	Out of Specification	Concentration Alarm LO
C028	Out of Specification	Concentration Alarm HI
C029	Failure	Concentration Alarm LO_LO
C040	Failure	Salinity Range
C041	Failure	Salinity Alarm LO_LO
C042	Out of Specification	Salinity Alarm LO
C043	Out of Specification	Salinity Alarm HI
C044	Failure	Salinity Alarm HI_HI
C045	Failure	Conductance Range
C060	User-defined	Sad Sensoface: Polarization
C061	User-defined	Sad Sensoface: Cable
C062	Maintenance Required	Sad Sensoface: Cell Constant
C070	Failure	TDS Range

Messages

C071	Failure	TDS Alarm LO_LO
C072	Out of Specification	TDS Alarm LO
C073	Out of Specification	TDS Alarm HI
C074	Failure	TDS Alarm HI_HI
C090	User-defined	USP Limit
C091	User-defined	Reduced USP Limit
C110	User-defined	CIP Counter
C111	User-defined	SIP Counter
C130	Text	SIP Cycle Counted
C131	Text	CIP Cycle Counted
C200	Out of Specification	Reference Temperature
C201	Out of Specification	Temperature Compensation
C202	Out of Specification	TC Adjustment Range
C203	Failure	TC Adjustment Range (Failure)
C204	Text	Cal: Sensor Unstable
C205	Text	Cal: Sensor Failure
C254	Text	Module Reset

No.	Message Type	Calculation Block COND / COND Messages
E010	Failure	Conductivity Diff Range
E011	Failure	Conductivity Diff LO_LO
E012	Out of Specification	Conductivity Diff Alarm LO
E013	Out of Specification	Conductivity Diff Alarm HI
E014	Failure	Conductivity Diff Alarm HI_HI
E015	Failure	Temperature Diff Range
E016	Failure	Temperature Diff Alarm LO_LO
E017	Out of Specification	Temperature Diff Alarm LO
E018	Out of Specification	Temperature Diff Alarm HI
E019	Failure	Temperature Diff Alarm HI_HI
E020	Failure	Resistivity Diff Range

Messages

No.	Message Type	Calculation Block COND / COND Messages
E021	Failure	Resistivity Diff Alarm LO_LO
E022	Out of Specification	Resistivity Diff Alarm LO
E023	Out of Specification	Resistivity Diff Alarm HI
E024	Failure	Resistivity Diff Alarm HI_HI
E030	Failure	RATIO Range
E031	Failure	RATIO Alarm LO_LO
E032	Out of Specification	RATIO Alarm LO
E033	Out of Specification	RATIO Alarm HI
E034	Failure	RATIO Alarm HI_HI
E035	Failure	PASSAGE Range
E036	Failure	PASSAGE Alarm LO_LO
E037	Out of Specification	PASSAGE Alarm LO
E038	Out of Specification	PASSAGE Alarm Hi
E039	Failure	PASSAGE Alarm HI_HI
E045	Failure	REJECTION Range
E046	Failure	REJECTION Alarm LO_LO
E047	Out of Specification	REJECTION Alarm LO
E048	Out of Specification	REJECTION Alarm Hi
E049	Failure	REJECTION Alarm HI_HI
E050	Failure	DEVIATION Range
E051	Failure	DEVIATION Alarm LO_LO
E052	Out of Specification	DEVIATION Alarm LO
E053	Out of Specification	DEVIATION Alarm Hi
E054	Failure	DEVIATION Alarm HI_HI
E055	Failure	c(NaOH) Range
E060	Failure	pH Value Range
E061	Failure	pH Value Alarm LO_LO
E062	Out of Specification	pH Value Alarm LO
E063	Out of Specification	pH Value Alarm HI
E064	Failure	pH Value Alarm HI_HI
E200	Maintenance Required	Calculation Block Configuration

Specifications

Specifications Protos COND 3400(X)-041

Cond input	Operation with 2- or 4-electrode sensors	
Conductivity	0.000 $\mu\text{S}/\text{cm}$... 1999 mS/cm	
Resistivity	0.5 $\Omega \text{ cm}$... 999 $\text{M}\Omega \text{ cm}$	
Concentration	0.00 ... 100.0 wt%	
Salinity	0.0 ... 45.0 g/kg (0 ... 35 $^{\circ}\text{C}$)	
Meas. range	4-electrode sensors: 0.1 $\mu\text{S} \times \text{c}$... 2000 $\text{mS} \times \text{c}$ ²⁾ 2-electrode sensors: 0.1 $\mu\text{S} \times \text{c}$... 200 $\text{mS} \times \text{c}$ ²⁾	
Display ranges	Resolution depending on cell constant	
	Cell constant	Resolution of cond.
	< 0.1200 cm^{-1}	0 $\mu\text{S}/\text{cm}$
	< 1.200 cm^{-1}	00.00 $\mu\text{S}/\text{cm}$
	< 12.00 cm^{-1}	000.0 $\mu\text{S}/\text{cm}$
	< 120.0 cm^{-1}	0.000 mS/cm
	$\geq 120.0 \text{ cm}^{-1}$	00.00 mS/cm
Response time t_{90}	Approx. 1 s	
Measurement error ³⁾	< 0.5 % meas. val. + 0.2 $\mu\text{S} \times \text{c}$ ²⁾	

Temp compensation ¹⁾	- Without
	- Linear characteristic 00.00 ... 19.99 %/K (reference temp user-defined)
	- NLF natural waters to EN 27888
	- Ultrapure water with NaCl traces (0 ... 120 $^{\circ}\text{C}$ / 32 ... 248 $^{\circ}\text{F}$)* _w
	- Ultrapure water with HCl traces (0 ... 120 $^{\circ}\text{C}$ / 32 ... 248 $^{\circ}\text{F}$)* _w
	- Ultrapure water with NH_3 traces (0 ... 120 $^{\circ}\text{C}$ / 32 ... 248 $^{\circ}\text{F}$)* _w
	- Ultrapure water with NaOH traces (0 ... 120 $^{\circ}\text{C}$ / 32 ... 248 $^{\circ}\text{F}$)* _w
	* _w for all waters: Reference temp 25 $^{\circ}\text{C}$ / 77 $^{\circ}\text{F}$

Specifications

Temperature input

Temperature probe ¹⁾	Pt100 / Pt1000 / NTC 30 kΩ / Ni 100 3-wire connection, adjustable	
Measurement range	Pt100 / Pt1000:	-50 ... 250 °C / -58 ... 482 °F
	NTC 30 kΩ:	-10 ... 150 °C / 14 ... 302 °F
	Ni 100:	-50 ... 180 °C / -58 ... 356 °F
Resolution	0,1 °C / °F	
Measurement error ³⁾	0.2 % meas.val. + 0.5 K	

Concentration determination ¹⁾

(SW3400-009/FW4400-009)	For the substances:	
HNO ₃	0 ... 30 wt%	-20 ... 50 °C / -4 ... 122 °F
	35 ... 96 wt%	-20 ... 50 °C / -4 ... 122 °F
HCl	0 ... 18 wt%	-20 ... 50 °C / -4 ... 122 °F
	22 ... 39 wt%	-20 ... 50 °C / -4 ... 122 °F
H ₂ SO ₄ ⁴⁾	0 ... 37 wt%	-17.8 ... 110 °C / -0.04 ... 230 °F
	28 ... 88 wt%	-17.8 ... 115.6 °C / -0.04 ... 240.08 °F
	89 ... 99 wt%	-17.8 ... 115.6 °C / -0.04 ... 240.08 °F
NaOH ⁵⁾	0 ... 24 wt%	0 ... 100 °C / 32 ... 212 °F
	15 ... 50 wt%	0 ... 100 °C / 32 ... 212 °F
NaCl	0 ... 28 wt%	0 ... 100 °C / 32 ... 212 °F
H ₂ SO ₄ ·SO ₃ (Oleum)	12 ... 45 wt%	0 ... 120 °C / 32 ... 248 °F
	User-defined concentration table (5x5 values)	

Sensor monitoring ¹⁾

Sensocheck;
Polarization and cable capacitance

Sensoface

Provides information on the sensor condition

Specifications

Sensor standardization ¹⁾	Operating modes - Automatic calibration with KCl or NaCl solution - Manual: entry of conductivity - Product calibration / adjustment to container - Entry of cell constant with simultaneous display of conductivity and temperature
Permissible cell constant	0.0050 ... 199.99 cm ⁻¹
Calibration record	Recording of: Cell constant, calibration method, with date and time

Output curves ¹⁾	Linear Trilinear Function (logarithmic) As desired via table
------------------------------------	---

USP function	Water monitoring in the pharmaceutical industry (USP) with possibility to enter a limit value (%) Output via relay contact (K1 ... K3, BASE) possible The USP value is available as USP% process variable (selectable for display, current output, limit value, measurement recorder).
---------------------	--

- 1) User-defined
2) $c = 0.0050 \dots 199.99 \text{ cm}^{-1}$
3) Rated operating conditions, ± 1 count, plus sensor error
4) Range limits based on 27 °C / 80.6 °F
5) Range limits based on 25 °C / 77 °F

Specifications

General Data

Explosion protection (Ex version of module only)	For entity parameters, see attachment to certificates or control drawings.
RoHS conformity	According to EU directive 2011/65/EU
EMC	EN 61326-1, EN 61326-2-3 NAMUR NE 21
Emitted interference	Industrial applications ¹⁾
Interference immunity	(EN 55011 Group 1 Class A) Industrial applications
Lightning protection	to EN 61000-4-5, Installation class 2
Rated operating conditions (module installed)	
Ambient temperature	Safe area: -20 ... 55 °C / -4 ... 131 °F Ex: -20 ... 50 °C / -4 ... 122 °F
Relative humidity	5 ... 95 %
Climatic class	3K5 according to EN 60721-3-3
Location class	C1 according to EN 60654-1
Transport/storage temperature	-20 ... 70 °C / -4 ... 158 °F
Screw clamp connectors	Single or stranded wires 0.2 ... 2.5 mm ² Tightening torque 0.5 ... 0.6 Nm
Wiring	Stripping length max. 7 mm Temperature resistance > 75 °C / 167 °F

1) This equipment is not designed for domestic use, and is unable to guarantee adequate protection of the radio reception in such environments.

Appendix

Minimum Spans for Current Outputs

The COND 3400(X)-041 module is a measuring module.

It does not provide current outputs.

Current outputs are provided by the BASE module (basic device) or by communication modules (e.g. OUT module).

The corresponding parameters must be set there.

The minimum current span shall prevent that the resolution limit of the measurement technology (± 1 count) is seen in the current.

COND 3400(X)-041 module

S/cm	20 %, min. 0.2 μ S/cm
wt%	1.00
°C	10.0
g/kg	1.00
Ohm*cm	20 %, min. 100.0 ohms*cm
°F	10.0

Calculation Block COND/COND

Diff S/cm	20 %, min. 0.2 μ S/cm
Diff °C	10.0
Diff Ohm*cm	20 %, min. 100.0 ohms*cm
RATIO	0.10
PASSAGE	10.0
REJECTION	10.0
DEVIATION	10.0
pH	1.00

Overview

Overview of Parameter Setting

Parameter Setting Menu

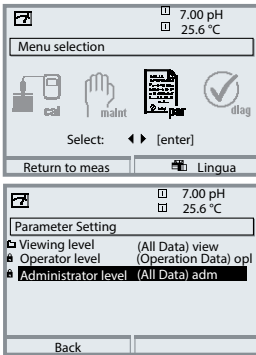

Parameter Setting

From measuring mode: Press **menu** key to select menu. Select parameter setting using arrow keys, press **enter** to confirm.

Administrator level

Access to all functions, also passcode setting. Releasing or blocking functions for access from the Operator level.

Operator level

Access to all functions which have been released at the Administrator level. Blocked functions are displayed in gray and cannot be edited.

Viewing level

Only display, no editing possible!

System Control

Memory card (Option)	Menu only appears when a memory card is inserted and the corresponding add-on function has been enabled.
Transfer configuration	The complete configuration of a device can be written on a memory card. This allows transferring all device settings to other devices with identical equipment (exception: options and passcodes).
Parameter set	2 parameter sets (A, B) are available in the device. The currently active parameter set is shown in the display. Parameter sets contain all settings except: sensor type, options, system control settings Up to 5 parameter sets (1, 2, 3, 4, 5) are available when a memory card (Option) is used.
Function control	Select the functions to be controlled via softkeys and OK inputs
Time/date	Time, date, display format
Meas. point description	Free input of a tag number, can be called from the diagnostics menu
Release of options	Option activation via TAN
Reset to default	Reset all parameters to factory setting
Passcode entry	Change passcodes
Firmware update	Update the firmware using an Update Card
Logbook	Select the events to be recorded

Note: The menus may vary depending on the device version

Overview

Overview of Parameter Setting

Parameter Setting Menu



FRONT Module: Display Settings

Language	Select the menu language
Units ¹⁾	Select the measurement units
Formats ¹⁾	Select the display format
Measurement display	Representation of measured values on the display
Display	Brightness/contrast, auto-off

BASE Module: Signal Outputs and Inputs, Contacts

Output current I1, I2	Separately adjustable current outputs
Contact K4	Failure signaling
Contacts K3, K2, K1	Separately adjustable relay contacts
Inputs OK1, OK2	Optocoupler signal inputs

Note: The menu may vary depending on the device version

1) With Protos II 4400(X) only

Parameter Setting Menu



COND 3400(X)-041 Module

Input filter	Pulse suppression
Sensor data <ul style="list-style-type: none"> • Sensor type • Nom. cell constant • Temperature detection <ul style="list-style-type: none"> - Temperature probe - Measuring temp - Calibration temp • Sensocheck 	Representation of measured values on the display: - Select - Selection for Measurement / Calibration
Protos 3400(X): Cal preset values <ul style="list-style-type: none"> • Cal solution • Product calibration 	Select the calibration solution (NaCl 0.01 mol/l, NaCl 0.1 mol/l, NaCl saturated, KCl 0.01 mol/l, KCl 0.1 mol/l, KCl 1 mol/l) Product calibration without/with temperature compensation
Protos II 4400(X): Cal Presettings Calibration Mode <ul style="list-style-type: none"> • Cal. Solution • Conductivity • Medium 	Automatic, Manual, Product, Data Entry, Temperature Automatic: Select cal. solution (NaCl 0.01 mol/l, NaCl 0.1 mol/l, NaCl saturated, KCl 0.01 mol/l, KCl 0.1 mol/l, KCl 1 mol/l) Product: Conductivity, Concentration ¹⁾ Product Calibration, Conductivity: With/Without TC Product Calibration, Concentration ¹⁾ : Select the medium
TC process medium	Set the temperature compensation (off, linear, EN 27888, ultrapure water ²⁾)
Concentration ¹⁾	
USP function	Monitoring of ultrapure water
Messages <ul style="list-style-type: none"> • Conductivity • Resistivity • Concentration ¹⁾ • Temperature • Salinity 	Off, Max. device limits, Variable limits

Note: The menus may vary depending on the device version.

Calibration Menu



COND 3400(X)-041 Module

Automatic
 Calibration solution input
 Product calibration
 Data entry
 Temp probe adjustment ¹⁾ Compensating for lead length

Maintenance Menu



BASE Module

Current source Output current definable 0 ... 22 mA

COND 3400(X)-041 Module

Sensor monitor For validation of sensor and complete signal processing
 Temp probe adjustment ²⁾ Compensating for lead length

Diagnostics Menu



Message list List of all messages
 Point of meas description Shows the tag number and annotation
 Logbook Shows the last events with date and time
 Device description Hardware version, Serial no., (Module) Firmware, Options

FRONT Module

Module diagnostics
 Display test
 Keypad test

BASE Module

Module diagnostics
 Input/output status

COND 3400(X)-041 Module

Module diagnostics Internal function test
 Sensor monitor Shows the values currently measured by the sensor
 Cal./Adj. record Data of last adjustment / calibration
 Temp. offset log ¹⁾

Note: The menus may vary depending on the device version.

1) with Protos II 4400(X) 2) with Protos 3400(X)

Index

A	
Adjusting the temperature probe (Protos 3400).....	57
Adjusting the temperature probe (Protos II 4400)	32
Adjustment.....	20
Administrator level	34
Application in hazardous locations.....	6
Automatic calibration with standard calibration solution.....	24
Automatic temperature compensation	21
B	
BASE module, parameter setting	53
Behavior during messages	56
Bilinear characteristic.....	54
C	
Calculation Blocks	45
Calibrating the sensors	31
Calibration	19
Calibration/adjustment record.....	60
Cal preset values.....	37
Cal record	60
Concentration.....	39
Concentration curves	39
Concentration table	43
Configuring the current output.....	53
Connecting the module	10
Contact assignments	9
Contacts, parameter setting.....	56
Corrective maintenance	6
Current outputs	53
Current outputs, characteristics.....	54
Current outputs, minimum spans.....	75
D	
Data entry of premeasured sensors	30
Device description, diagnostics menu	61
Device firmware.....	7
Device limits max.	52

Index

Diagnostic messages	65
Diagnostic messages as favorite	62
Diagnostics	59
Disposal	2
E	
Electrostatic discharge (ESD)	10
EMC	74
Error messages	65
Explosion protection, safety instructions.....	6
F	
Factory setting	50
Favorites.....	62
Firmware version	7
Function control matrix	62
H	
Hardware/Firmware version.....	7
Hydrochloric acid	40
I	
Input filter	37
Installing the module	10
Intended use	5
L	
Linear characteristic	54
Lock icon.....	35
Locking a function	35
Logarithmic output curve	55
Logbook, diagnostics menu.....	59
Logbook (parameter setting).....	50
M	
Maintenance menu	57
Manual entry of cal solution	26
Manual temperature compensation.....	21
Measuring point description	59

Index

Message icons	52
Message list	64
Messages	52
Messages with Protos 3400(X)	65
Messages with Protos II 4400(X)	68
Minimum spans for current outputs	75
Module compatibility	7
Module diagnostics	60
Module firmware	7
Module installation	10

N

Nitric acid	40
-------------------	----

O

Oleum	42
Open parameter setting	36
Operating levels	34
Operator level	34
Optocoupler inputs	56
Output filter	56
Overview of parameter setting	76

P

Parameter setting	34
Parameter setting, overview	76
Parameter setting: TC process medium	37
pH value calculation	48
Point of meas description	59
Product calibration	28

R

Rated operating conditions	74
Reduced limit	44
Release (softkey function)	35
Restore factory settings	50
Returns	2

Index

S	
Safety Instructions	6
Salt solution.....	41
Secondary displays	62
Sensor connection, example	11
Sensor data	37
Sensor monitor, diagnostics menu.....	60
Sensor monitor, maintenance menu	57
Serial number, display	7
Sodium hydroxide solution	41
Softkeys, function control	62
Specifications.....	71
Sulfuric acid.....	39
T	
Table of contents.....	3
TC process medium.....	37
Technical data.....	71
Temperature compensation during calibration.....	21
Temp. offset log	60
Temp probe adjustment (Protos 3400)	57
Temp probe adjustment (Protos II 4400).....	32
Trilinear characteristic	54
U	
Ultrapure water.....	38
USP function	44
V	
Variable limits	52
Viewing level.....	34
W	
Wiring examples.....	11



Knick
Elektronische Messgeräte
GmbH & Co. KG

Headquarters

Beuckestraße 22 • 14163 Berlin

Germany

Phone: +49 30 80191-0

Fax: +49 30 80191-200

info@knick.de

www.knick.de

Local Contacts

www.knick-international.com

Copyright 2020 • Subject to change

Version: 10

This document was published on November 13, 2020.

The latest documents are available for download on our website below the corresponding product description.



097697

TA-201.041-KNEN10

Firmware version: 2.x