

User Manual

Stratos MS A405

Conductivity Measurement

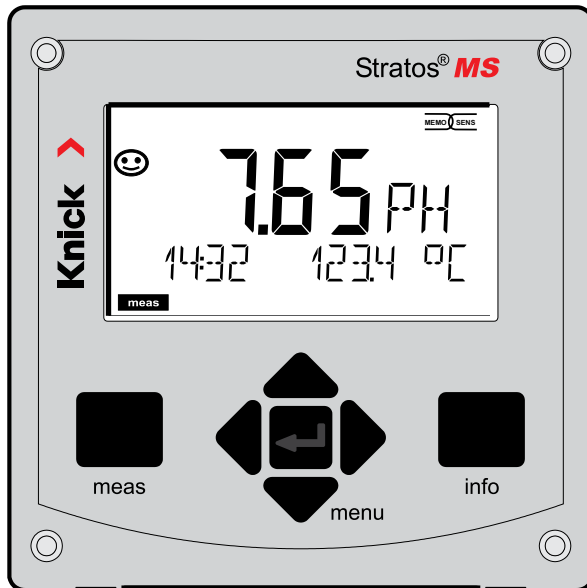

Read before installation.
Keep for future use.



Supplemental Directives

Read this document and retain it for future reference. Before assembling, installing, operating, or maintaining the product, ensure that you fully understand the instructions and risks. Observe all safety instructions. Failure to follow the instructions in this document may result in serious injury and/or property damage.

This document is subject to change without notice.

These supplemental directives explain how safety information is laid out in this document and what content it covers.

Safety Chapter



This document's Safety chapter is designed to give the reader a basic understanding of safety. It illustrates general hazards and gives strategies on how to avoid them.

Safety Guide

The external Safety Guide is designed to give the reader a basic understanding of safety. It illustrates general hazards and suggests strategies on how to avoid them.

Warnings

This document uses the following warnings to indicate hazardous situations:

Symbol	Category	Meaning	Remark
	WARNING	Designates a situation that can lead to death or serious (irreversible) injury.	The warnings contain information on how to avoid the hazard.
	CAUTION	Designates a situation that can lead to slight or moderate (reversible) injury.	
None	NOTICE	Designates a situation that can lead to property or environmental damage.	

Additional Safety Information

Stratos Safety Guide

Table of Contents

Supplemental Directives	2
Documents Supplied	5
Safety	6
Intended Use.....	7
Introduction	8
Assembly	9
Package Contents.....	9
Mounting Accessories	10
Pipe Mounting, Protective Hood	11
Panel Mounting	12
Electrical Installation	13
Terminal Assignments, Rating Plates	13
Power Supply	14
Start-Up	15
Calibration and Maintenance in the Lab	15
Wiring Example SE670 / SE680.....	16
Measuring Mode	17
The Keys and Their Functions	18
The Display	19
Display in Measuring Mode	20
Operating Modes	22
HOLD Mode.....	23
Operating Modes / Functions.....	24
Menu Structure of Configuration	25
Connecting a Memosens Sensor	26
Replacing a Sensor.....	27
Configuration	29
Configuration: Overview	29
Configuring the Sensor	32
Device Type: Cond / Condl.....	32
Configuring the Current Output.....	38
Output Current: Logarithmic Curve.....	42

Table of Contents

Configuring the Alarm.....	48
Temperature Compensation	50
Selecting the compensation method.....	50
Configuring the Relay Contacts	52
Protective Wiring of Relay Contacts.....	60
Configuring the Time/Date	62
Calibration	65
Calibration with Calibration Solution	66
Calibration by Input of Cell Constant / Cell Factor	68
Calibration by Input of an Installation Factor.....	69
Product Calibration	70
Temp Probe Adjustment.....	72
Calibrating Toroidal Sensors.....	73
Zero Calibration	74
Measurement.....	75
Diagnostics	76
Service	81
Operating Error!.....	84
Error Messages.....	86
Sensocheck and Sensoface	88
Decommissioning	89
Disposal	89
Returns.....	89
Operating States.....	90
Product Range	91
Specifications.....	92
Calibration Solutions	97
Concentration Measurement.....	99
Concentration Curves.....	100
Index.....	106

Safety Guide

In official EU languages and others

Quickstart Guides

Installation and first steps:

- Operation
- Menu structure
- Calibration
- Error messages and recommended actions

Test Report 2.2 According to EN 10204

Electronic Documentation

www.knick-international.com:

Manuals + software

Safety

Always Read and Observe the Safety Instructions!

The device is constructed in accordance with the latest technology and generally accepted safety rules and regulations.

Under certain circumstances, however, usage may pose risks to users or cause damage to the device.

Commissioning must be carried out by specialist personnel authorized by the operating company. If safe operation is not possible, the device must not be switched on or, if it is already on, must be switched off properly and secured against unintended operation.

Reasons to assume safe operation is not possible:

- the device shows visible damage
- failure to perform the intended function
- prolonged storage at temperature of below $-30\text{ }^{\circ}\text{C}/-22\text{ }^{\circ}\text{F}$ or above $70\text{ }^{\circ}\text{C}/158\text{ }^{\circ}\text{F}$
- severe transport stresses

Before recommissioning the device, a professional routine test must be performed. This test should be carried out by the manufacturer at its factory.

Mains Connection

The device does not have a power switch. An appropriately arranged and accessible disconnecting device for the transmitter must be present in the system installation. The disconnecting device must disconnect all non-grounded, current-carrying wires. The disconnecting device must be labeled in a way that enables the associated transmitter to be identified. The power line may carry dangerous touch voltages. Touch protection must be ensured by proper installation.

Personnel Requirements

Customer shall ensure that any personnel using or otherwise interacting with the product is adequately trained and has been properly instructed.

The operating company shall comply and cause its personnel to comply with all applicable laws, regulations, codes, ordinances and relevant industry qualification standards related to product. Failure to comply with the foregoing shall constitute a violation of operating company's obligations concerning the product, including but not limited to an unintended use as described in this document.

Intended Use

Stratos MS is a 4-wire analyzer for use with Memosens sensors. Current is provided through a universal power supply 80 ... 230 V AC, 45 ... 65 Hz / 24 ... 60 V DC. The analyzer provides two 0 (4) ... 20 mA current outputs for transmission of measured value and temperature, for example.

Two floating relay contacts are available for free configuration.

You can select one of the following measuring functions:

- pH
- ORP
- Dissolved oxygen
- Conductivity measurement (conductive/inductive)

The defined rated operating conditions must be observed when using this product. They can be found in the Specifications chapter of this User Manual; see page 92.

Function Check Mode (HOLD Function)

After activating configuration, calibration, or service, Stratos MS enters function check mode (HOLD).

The current outputs respond in accordance with the configuration.

Operations must not be carried out while Stratos Pro is in function check (HOLD) mode, as the system may behave unexpectedly and put users at risk.

Introduction

Enclosure and mounting possibilities

- The sturdy molded enclosure is rated IP66/IP67 / TYPE 4X Outdoor.

Material of front unit: PBT, rear unit: PC.

Dimensions: H 148 mm, W 148 mm, D 117 mm.

It is provided with knockouts to allow:

- panel mounting (138 mm x 138 mm cutout to DIN 43700)
- wall mounting (with sealing plugs to seal the enclosure)
- post/pipe mounting (dia. 40 ... 60 mm, □ 30 ... 45 mm)

Protective hood (accessory)

The protective hood provides additional protection against direct weather exposure and mechanical damage (available as accessory).

Connection of sensors, cable glands

For connecting the cables, the enclosure provides

- 3 knockouts for cable glands M20x1.5
- 2 knockouts for NPT 1/2" or rigid metallic conduit

For quasi-stationary installations with Memosens sensors, we recommend using the M12 socket accessory (ZU0822) instead of a cable gland – which allows simple replacement of the sensor cable without opening the device.

Memosens sensors and connecting cables

Please visit our website for more information on our product range: www.knick.de.

Package Contents

Check the shipment for transport damage and completeness.

The package should contain:

Front unit, rear unit, bag containing small parts

Specific test report

Documentation

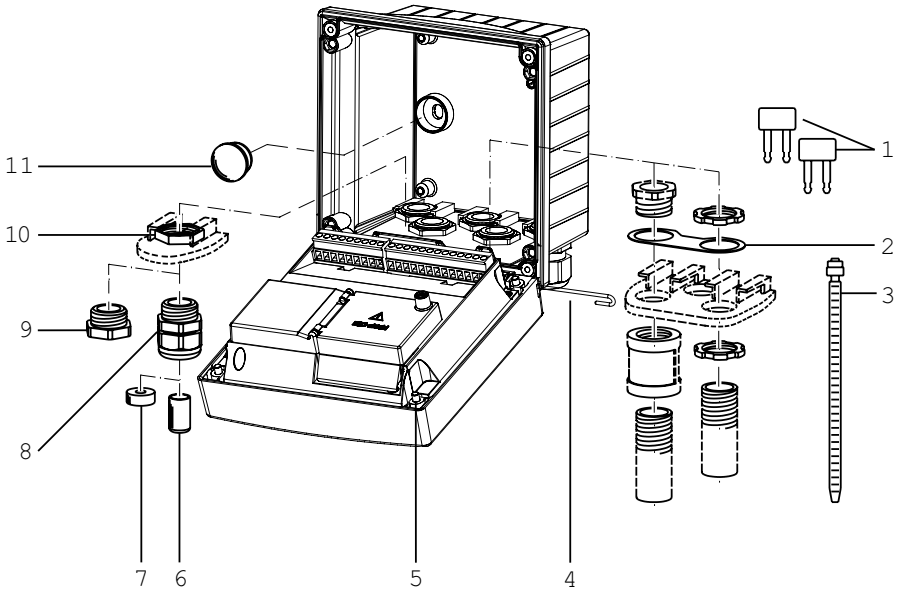
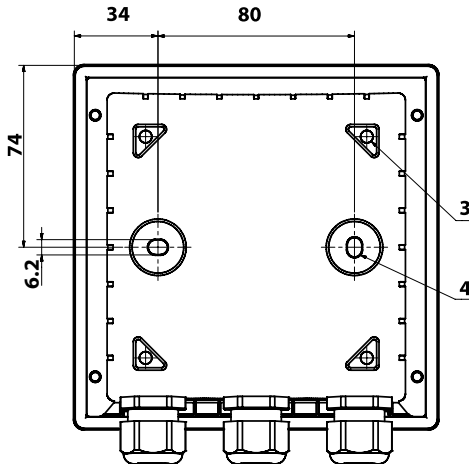
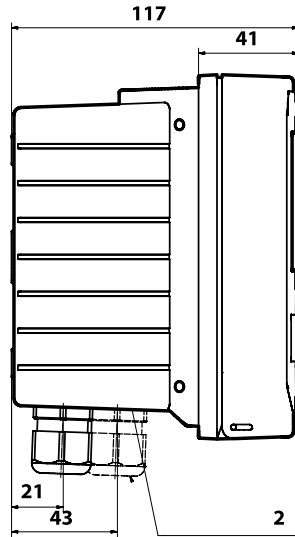
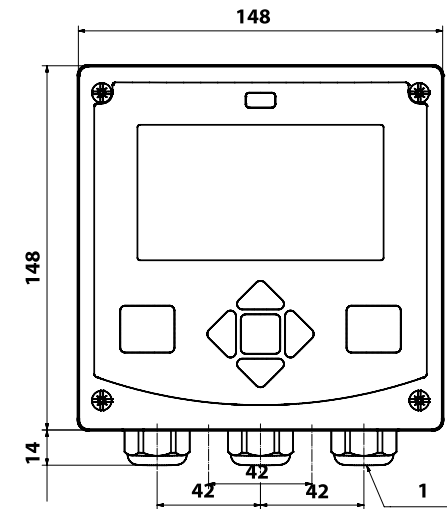

Fig.: Assembling the enclosure

- | | |
|---|--|
| 1) Insertable jumper (3x) | 6) Blanking plug (2x) |
| 2) Plate (1x), for conduit mounting:
Plate between housing and nut | 7) Reduction sealing insert (1x) |
| 3) Cable tie (3x) | 8) Cable gland (3x) |
| 4) Hinge pin (1x), insertable from
either side | 9) Blanking cap (2x) |
| 5) Enclosure screw, captive (4x) | 10) Hex nut (5x) |
| | 11) Plastic sealing plug (2x),
for sealing in case of wall mounting |

Mounting Plan, Dimensions



- 1) Cable gland (3x)
- 2) Knockouts for cable gland or ½" conduit, dia. 21.5 mm (2 knockouts).
Conduit couplings not included!
- 3) Knockout for pipe mounting (4x)
- 4) Knockout for wall mounting (2x)

Mounting Accessories

Pipe-mount kit, accessory ZU0274

Protective hood for wall and pipe mounting, accessory ZU0737

Panel-mount kit, accessory ZU0738

All dimensions in mm

Pipe Mounting, Protective Hood

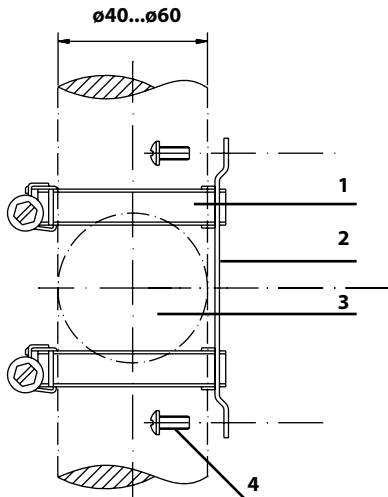

- 1) Hose clamp with worm gear drive to DIN 3017 (2x)
- 2) Pipe-mount plate (1x)
- 3) For vertical or horizontal posts or pipes
- 4) Self-tapping screw (4x)

Fig.: Pipe-mount kit, accessory ZU0274

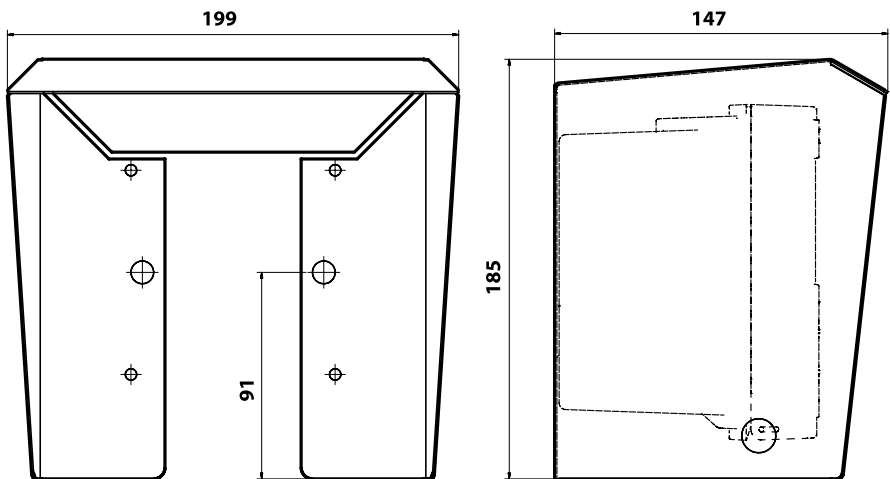
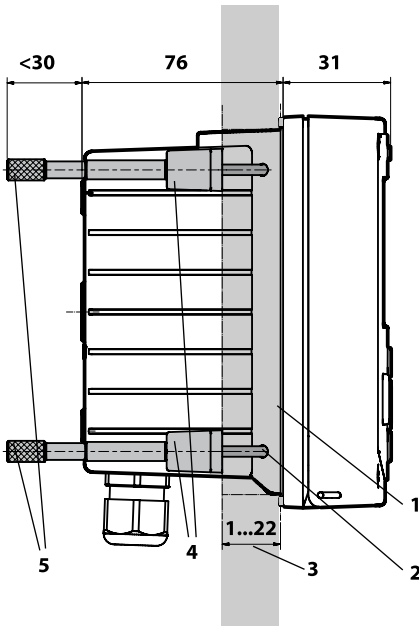

Fig.: Protective hood for wall and pipe mounting, accessory ZU0737

All dimensions in mm

Panel Mounting



- 1) Circumferential sealing (1 x)
- 2) Screw (4 x)
- 3) Position of control panel
- 4) Span piece (4 x)
- 5) Threaded sleeve (4 x)

Cutout
138 x 138 mm (DIN 43700)

Fig.: Panel-mount kit, accessory ZU0738

Overview of the Stratos MS

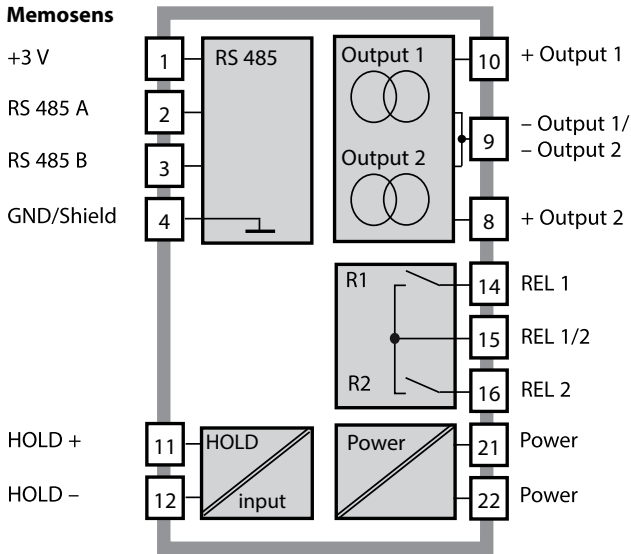

Terminal Assignments, Rating Plates

The terminals are suitable for single or stranded wires up to 2.5 mm² (AWG 14).

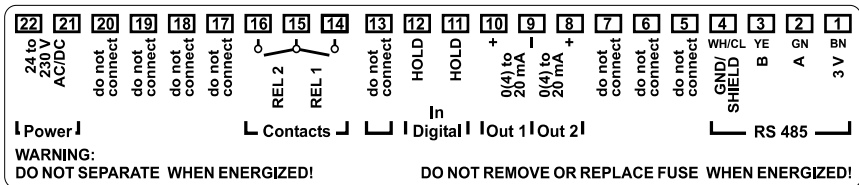

Fig.: Terminal assignments of Stratos MS

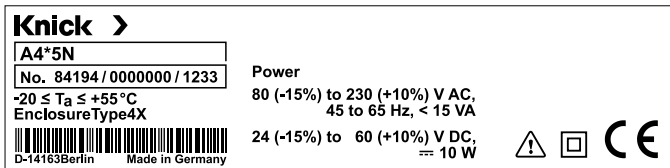
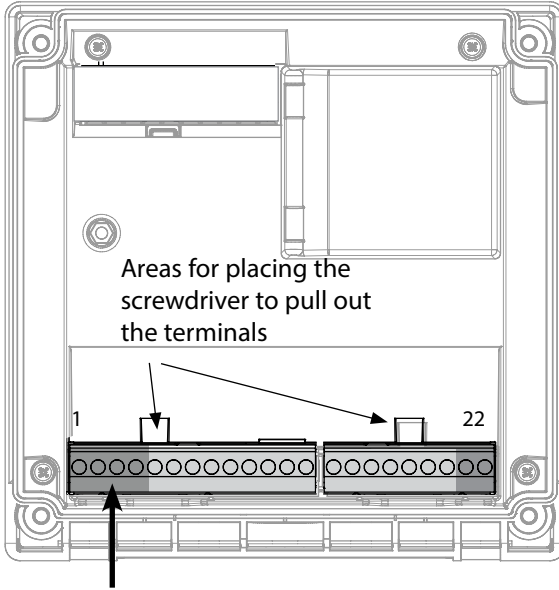

Fig.: Stratos MS rating plate at outside bottom of front (illustrative example)

Electrical Installation

Power Supply

Connect the power supply for Stratos MS to terminals 21 and 22
(80 ... 230 V AC, 45 ... 65 Hz / 24 ... 60 V DC)



Connection of Memosens sensor		
1	Brown	+3 V
2	Green	RS 485 A
3	Yellow	RS 485 B
4	White/Transp.	GND/shield

Terminal assignments

Memosens connection		
1 (BN)	+3 V	Brown
2 (GN)	RS 485 A	Green
3 (YE)	RS 485 B	Yellow
4 (WH/CL)	GND/shield	White / Transp.
5	do not connect	
6	do not connect	
7	do not connect	
Current outputs OUT1, OUT2		
8	+ Out 2	
9	- Out 1 / Out 2	
10	+ Out 1	
11	HOLD	
12	HOLD	
13	do not connect	
Relay contacts REL1, REL2		
14	REL 1	
15	REL 1/2	
16	REL 2	
17	do not connect	
18	do not connect	
19	do not connect	
20	do not connect	
Power supply		
21	power	
22	power	

Figure:
Terminals, device opened,
back of front unit

Start-Up

When a Memosens sensor is connected, the appropriate measuring function (device type) is automatically loaded.

Changing the Measuring Function

In the "Service" menu you can select another measuring function at any time.

Calibration and Maintenance in the Lab

The "MemoSuite" software allows calibrating Memosens sensors under reproducible conditions at a PC in the lab. The sensor parameters are registered in a database. Documenting and archiving meet the demands of FDA CFR 21 Part 11. Detailed reports can be output as csv export for Excel. MemoSuite is available as accessory and comes in the versions "Basic" and "Advanced": www.knick.de.

Settings and specifications

Connected sensor: sensor type, manufacturer, order code and serial number

Function selection:
The selected function is highlighted.

Connected sensor:
sensor type, manufacturer, order code and serial number, measuring point and tag number

Last adjustment

You can magnify a measured-value display at a click of the mouse.

Measured values

Conductivity	1.010 mS/cm
Resistance	1.00 kΩ
Temperature	25 °C

Sensor data

Sensor type: Conductivity
Manufacturer: Knick
Order code: SE630-MS
Serial number: 11003
Measuring point:
Tag number: 7

Adjustment data

Date: 4/27/2015 20:09:12
Cell constant: 1.01 1/cm

Conductivity
1.010 mS/cm

Wiring Example SE670 / SE680

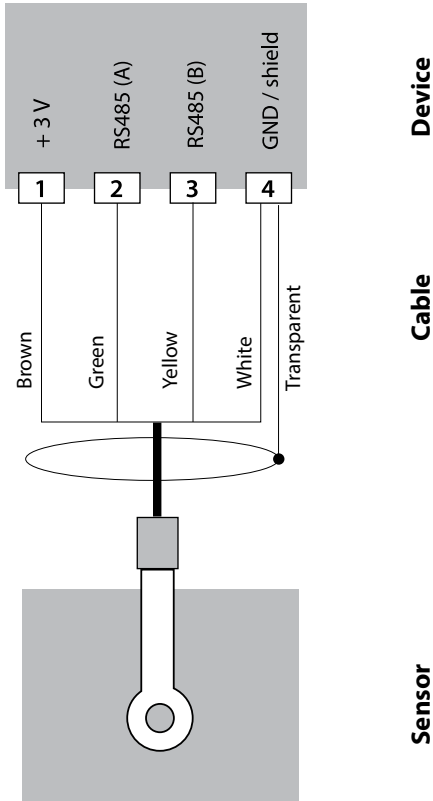

Connect the SE670 / SE680 sensor to the RS-485 interface of the device. When SE670 / SE680K is selected as sensor in the Configuration menu, the default values are taken as calibration data. They can then be modified by calibration. All calibration data of the SE680M sensor with Memosens protocol are stored in the sensor.

Measuring Mode

After the operating voltage has been connected, the analyzer automatically goes to “Measuring” mode. To call the measuring mode from another operating mode (e.g., Diagnostics, Service): Hold **meas** key depressed (> 2 s).

Sensoface indicator
(sensor status)

Time

Mode indicator
(measuring)

Hold **meas** key
depressed
for calling the measuring
mode
(hitting the key once more
switches the display)

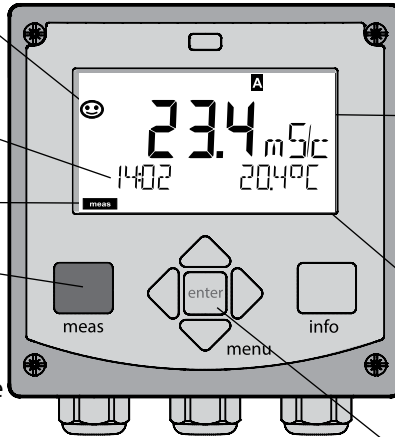

Display indicates
OUT1:
e.g., measured
value

Display indicates
OUT2:
e.g.,
temperature

enter key

Depending on the configuration, you can set various displays as standard display for the measuring mode (see page 20).

Note: By pressing the **meas** key in measuring mode you can view the displays for approx. 60 sec.



You must configure the analyzer for the respective measurement task, see page 29.

The Keys and Their Functions

Up / Down arrows

- Menu: Increase/decrease a numeral
- Menu: Selection

Left / Right arrows

- Menu: Previous/next menu group
- Number entry: Move between digits

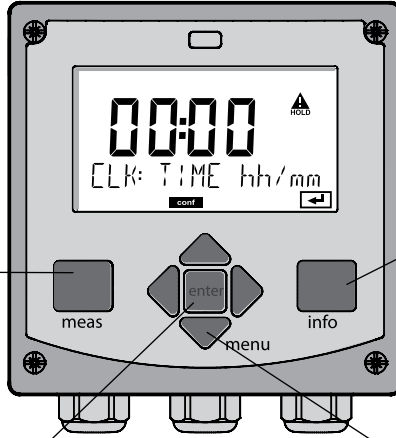

meas

- Return to last menu level
- Directly to measuring mode (press > 2 s)
- Measuring mode: other display (temporarily for approx. 60 s)

info

- Retrieve information
- Show error messages

enter

- Configuration: Confirm entries, next configuration step
- Calibration: Continue program flow

menu

- Measuring mode: Call menu

The Display

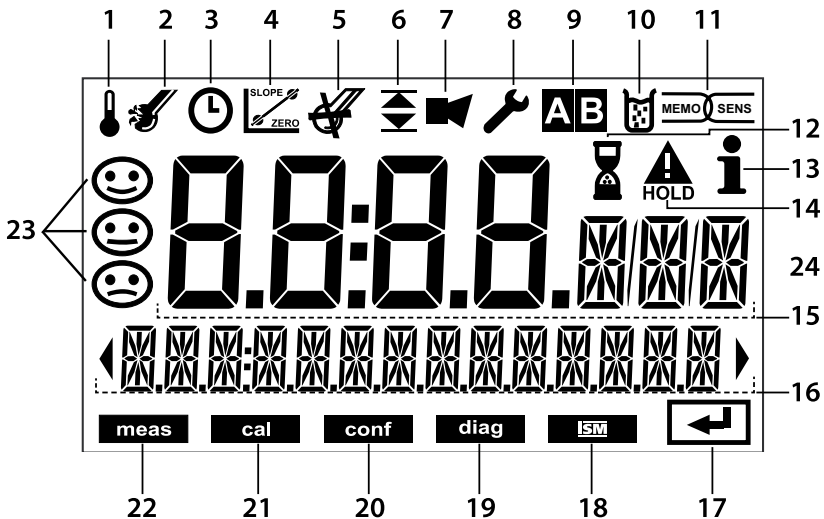

- | | | | |
|----|--|----|-----------------------|
| 1 | Temperature | 13 | Info available |
| 2 | Sensocheck | 14 | HOLD mode active |
| 3 | Interval/response time | 15 | Primary process value |
| 4 | Sensor data | 16 | Secondary display |
| 5 | Wear | 17 | Proceed using enter |
| 6 | Limit message:
Limit 1 ▼ or Limit 2 ▲ | 18 | Not used |
| 7 | Alarm | 19 | Diagnostics |
| 8 | Service | 20 | Configuration mode |
| 9 | Not used | 21 | Calibration mode |
| 10 | Calibration | 22 | Measuring mode |
| 11 | Memosens sensor | 23 | Sensoface |
| 12 | Waiting time running | 24 | Unit symbols |

Signal Colors (Display Backlighting)

- | | |
|--------------|--|
| Red | Alarm (in case of fault: display values blink) |
| Red blinking | Input error: illegal value or wrong passcode |

Operation

Display in Measuring Mode

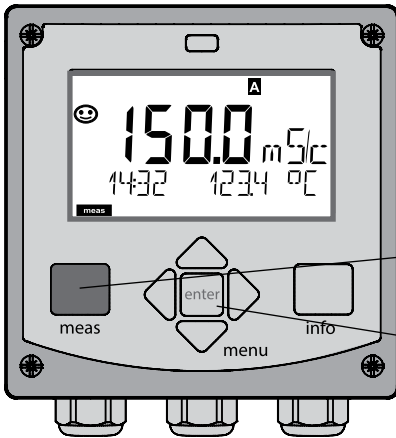

The MAIN DISPLAY is the display which is shown in measuring mode. To call the measuring mode from any other mode, hold the **meas** key depressed for at least 2 sec.

meas key

enter key

meas



meas

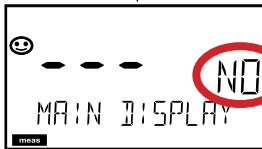

approx. 2 s

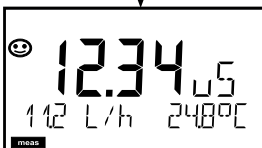

By pressing **meas** briefly you can step through further displays such as primary value or tag number (TAG).

After 60 sec they switch back to the main display.

Press **enter** to select a display as MAIN DISPLAY (displayed permanently in measuring mode).

The secondary display shows "MAIN DISPLAY – NO".

Use the **UP / DOWN** arrows to select "MAIN DISPLAY – YES" and confirm by pressing **enter**.

This display is now shown in measuring mode.

To select the operating mode:

- 1) Hold **meas** key depressed (> 2 s) (measuring mode)
- 2) Press **menu** key: the selection menu appears
- 3) Select operating mode using left / right arrow key
- 4) Press **enter** to confirm the selected mode

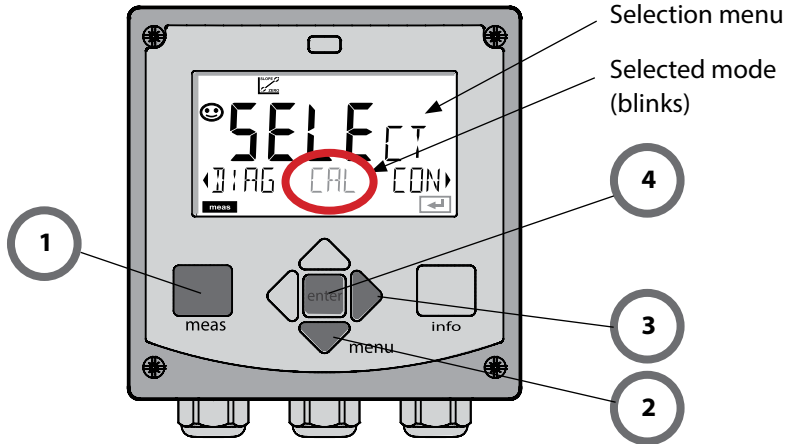

To enter a value:

- 5) Select numeral: left / right arrow
- 6) Change numeral: up / down arrow
- 7) Confirm entry by pressing **enter**

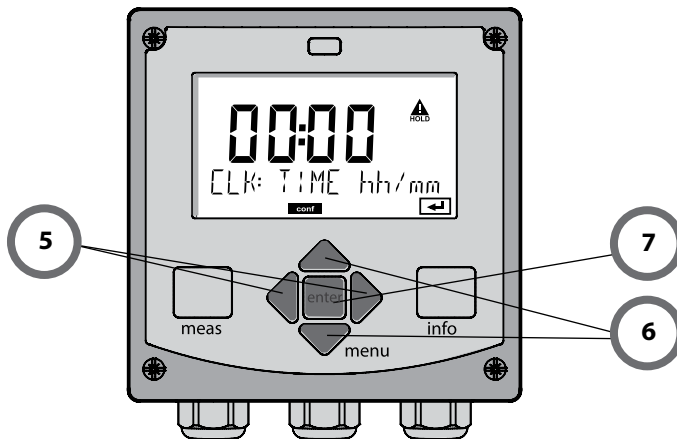

Operating Modes

Diagnostics

Display of calibration data, display of sensor data, sensor monitor, performing a device self-test, viewing the logbook entries, display of hardware/software versions of the individual components. The logbook can store 100 events (00...99). They can be displayed directly on the device.

HOLD

Manual activation of HOLD mode, e.g., for replacing a sensor.

The signal outputs adopt a defined state. HOLD can also be activated via the external input (see next page).

Calibration

Every sensor has typical characteristic values, which change in the course of the operating time. Calibration is required to supply a correct measured value. The device checks which value the sensor delivers when measuring in a known solution. When there is a deviation, the device can be "adjusted". In that case, the device displays the "actual" value and internally corrects the measurement error of the sensor. Calibration must be repeated at regular intervals. The time between the calibration cycles depends on the load on the sensor. During calibration the device is in HOLD mode.

During calibration the device remains in the HOLD mode until it is stopped by the operator.

Configuration

You must configure the analyzer for the respective measurement task. In the "Configuration" mode you select the connected sensor, the measuring range to be transmitted, and the conditions for warning and alarm messages. During configuration the device is in HOLD mode.

Configuration mode is automatically exited 20 minutes after the last keystroke. The device returns to measuring mode.

Service

Maintenance functions (current source, relay test), assigning passcodes, selecting the device type (pH/oxy/conductivity), resetting to factory settings.

The HOLD mode is a safety state during configuration and calibration.

Output current is frozen (LAST) or set to a fixed value (FIX).

Alarm and limit contacts are disabled.

HOLD mode, display icon:



Output signal response

- **LAST:** The output current is frozen at its last value. Recommended for short configuration procedures. The process should not change decisively during configuration. Changes are not noticed with this setting!
- **FIX:** The output current is set to a value that is noticeably different from the process value to signal the control system that the device is being worked at.

Output signal during HOLD:

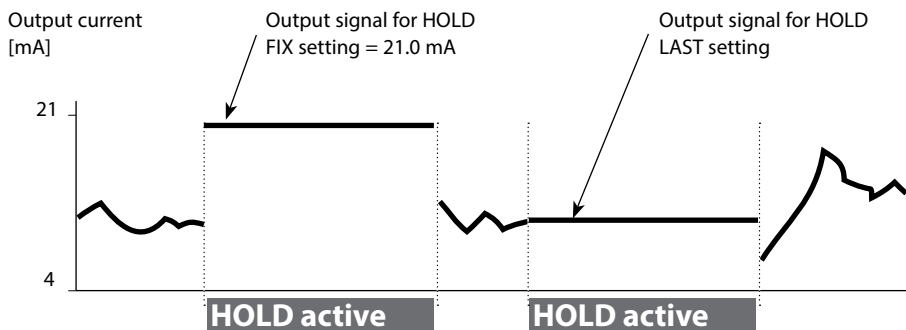

Terminating the HOLD mode

The HOLD mode is exited by switching to measuring mode (hold **meas** key depressed). The display reads “Good Bye“. After that, the HOLD mode is exited.

When the calibration mode is exited, a confirmation prompt ensures that the installation is ready for operation (e.g.: sensor reinstalled, located in process).

External activation of HOLD

The HOLD mode can be activated from outside by sending a signal to the HOLD input (e.g., from the process control system).

HOLD inactive	0...2 V AC/DC
HOLD active	10...30 V AC/DC

Operating Modes / Functions

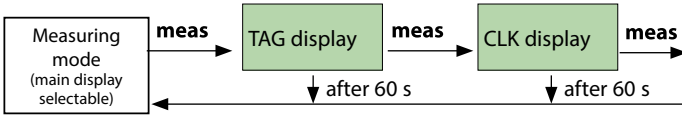

Pressing the **menu** key (down arrow) opens the selection menu. Select the menu group using the left/right arrow keys. Pressing **enter** opens a menu item. Press **meas** to return.

DIAG

CALDATA	Display of calibration data
SENSOR	Display of sensor data
SELFTEST	Self test: RAM, ROM, EEPROM, module
LOGBOOK	100 events with date and time
MONITOR	Display of direct sensor values
VERSION	Display of software version, model designation, serial no.

HOLD

Manual activation of HOLD mode, e.g., for sensor replacement. The signal outputs behave as configured (e.g., last measured value, 21 mA)

CAL

pH	pH adjustment / ORP adjustment / product calibration
Oxy	Adjustment (WTR/AIR) / zero adjustment / prod. cal.
COND(I)	Adjustment with solution / factor input / prod. cal.
CAL_RTd	Adjustment of temperature probe

CONF

CONF	Configuration See "Overview of Configuration" on next page.
------	--

SERVICE

(Access via code, factory setting: 5555)

MONITOR	Display of measured values for validation (simulators)
OUT1	Current source, output 1
OUT2	Current source, output 2
RELAIS	Relay test
CODES	Specifying access codes for operating modes
DEVICE TYPE	Selecting the device type
DEFAULT	Reset to factory setting

Menu Structure of Configuration

The configuration steps are assigned to different menu groups.

Using the left/right arrow keys, you can jump between the individual menu groups.

Each menu group contains menu items for setting the parameters.

Pressing **enter** opens a menu item. Use the arrow keys to edit a value.

Press **enter** to confirm/save the settings.

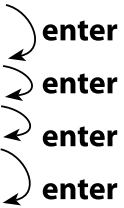

Return to measurement: Hold **meas** key depressed (> 2 s).

Select menu group	Menu group	Code	Display	Select menu item
	Sensor settings	SNS:	Conf ^A i SENSOR	 enter enter enter enter
		Menu item 1		
		:		
		Menu item ...		
▶	Current output 1	OT1:	Conf ^A i OUT 1	
▶	Current output 2	OT2:	Conf ^A i OUT 2	
▶	Compensation	COR:	Conf ^A i CORRECT:ON	
▶	Alarm mode	ALA:	Conf ^A i ALARM	
▶	Relay outputs (LIMIT / ALARM / WASH)	REL:	Conf ^A i REL 1/REL 2	
▶	Setting the clock	CLK:	Conf ^A i CLOCK	
▶	Tag number	TAG:	Conf ^A i TAG	◀

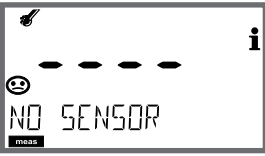
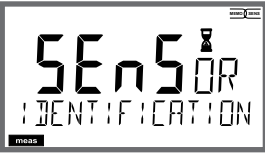
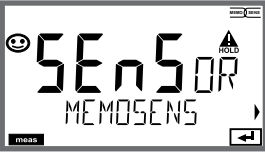
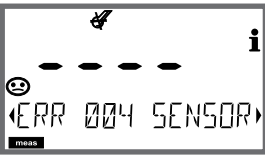
Connecting a Memosens Sensor

Step	Action/Display	Remark
Connect sensor		When no Memosens sensor is connected, the error message "NO SENSOR" is displayed.
Wait until the sensor data are displayed.		The hourglass in the display blinks.
Check sensor data	 <p data-bbox="389 724 654 820">View sensor information using ◀ ▶ keys, confirm using enter.</p>	Sensoface is friendly when the sensor data are okay.
Go to measuring mode	Press meas , info or enter	After 60 sec the device automatically returns to measuring mode (timeout).
Possible error message		
Sensor defective. Replace sensor		When this error message appears, the sensor cannot be used. Sensoface is sad.

Replacing a Sensor

Step	Action/Display	Remark
<p>Select HOLD mode A sensor should only be replaced during HOLD mode to prevent unintended reactions of the outputs or contacts.</p>	<p>Press menu key to call the selection menu, select HOLD using the ◀ ▶ keys, press enter to confirm.</p>	<p>Now the device is in HOLD mode. The HOLD mode can also be activated externally via the HOLD input. During HOLD the output current is frozen at its last value or set to a fixed value.</p>
<p>Disconnect and remove old sensor</p>		
<p>Install and connect new sensor.</p>		<p>Temporary messages which are activated during the replacement are indicated but not output to the alarm contact and not entered in the logbook.</p>
<p>Wait until the sensor data are displayed.</p>		
<p>Check sensor data</p>	 <p>View sensor information using ◀ ▶ keys, confirm using enter.</p>	<p>You can view the sensor manufacturer and type, serial number and last calibration date.</p>
<p>Check measured values</p>		
<p>Exit HOLD</p>	<p>Hit meas key: Return to the selection menu. Hold meas key depressed: Device switches to measuring mode.</p>	

⚠ CAUTION! Incorrect parameter settings or adjustments can result in incorrect outputs. Stratos MS must therefore be commissioned by a system specialist, all its parameters must be set, and it must be fully adjusted. For detailed information on parameter setting and adjustment, see the user manual

Configuration: Overview

Configuration (default in bold print)			
Sensor		Cond	
SNS	MEAS MODE	Cond Conc % SAL ‰	
	Cond	MEAS RANGE	
			x.xxx µS/cm * xx.xx µS/cm * xxx.x µS/cm * xxxx µS/cm * x.xxx mS/cm xxxx mS/cm ** xx.xx mS/cm xxx.x mS/cm x.xxx S/m xx.xx S/m xx.xx MΩ *
	Conc	SOLUTION	-01- (NaCl) -02- (HCl) -03- (NaOH) -04- (H ₂ SO ₄) -05- (HNO ₃) -06- (H ₂ SO ₄) -07- (HCl) -08- (HNO ₃) -09- (H ₂ SO ₄) -10- (NaOH) -11- (H ₂ SO ₄ +SO ₃) (oleum) -U1-
		TEMP UNIT	°C / °F
		CHECK TAG	OFF / ON
	CHECK GROUP	OFF / ON	

* not for toroidal (inductive) conductivity sensors ** only for inductive conductivity measurement

Configuration: Overview

Configuration (default in bold print)			
Current output 1		Cond	
OT1	RANGE	4 ... 20 mA / 0 ... 20 mA	
	CHANNEL	COND / TMP	
	OUTPUT (Current output curve)	LIN / BILIN / LOG (LOG for S/cm and S/m only)	
	LIN	BEGIN 0/4 mA	Floating-point input, 000.0 mS/c
		END 20 mA	Floating-point input, 100.0 mS/c
	LOG	BEGIN 0/4 mA	Selectable decades: S/cm: 1.0 μ S/cm / 10.0 μ S/cm / 100.0 μ S/cm / 1.0 mS/c / 10.0 mS/c / 100.0 mS/c / 1000 mS/c S/m: 0.001 S/m / 0.01 S/m / 0.1 S/m / 1.0 S/m / 10.0 S/m / 100 S/m
		END 20 mA	Decades (see above) 100.0 mS/c
	BI LIN	BEGIN 0/4 mA	Range depending on selected channel
		END 20 mA	Range depending on selected channel
		CORNER X	Conditions for bilinear characteristic: Vertex X: BEGIN \leq CORNER X \leq END (rising) BEGIN \geq CORNER X \geq END (falling)
		CORNER Y	Default: 12 mA Vertex Y: (0 mA) 4 mA \leq CORNER Y \leq 20 mA
	TMP °C	BEGIN 0/4 mA	-50 ... 250 °C (000.0 °C)
		END 20 mA	-50 ... 250 °C (100.0 °C)
	TMP °F	BEGIN 0/4 mA	-58 ... 482 °F (032.0 °F)
		END 20 mA	-58 ... 482 °F (212.0 °F)
ERROR	Output current for error message OFF / FAIL / FACE (Sensoface)		
FILTERTIME	Output filter, time interval 0 s ... 120 s (0 s = filter OFF)		
HOLD	Output current for HOLD LAST / FIX		
Current output 2		Default setting CHANNEL: TMP (other settings like OT1)	

Correction		Cond	
COR	TC SELECT	OFF / LIN / NLF / compensation for ultrapure water: NaCl, HCl, NH3, NaOH	
	LIN	TC LIQUID	00.00 ... 19.99 %/K (00.00 %/K)
		REF TEMP	000.0 ... 199.9 °C (025.0 °C)

Configuration: Overview

Configuration (default in bold print)		
Alarm		
ALA	DELAYTIME	Delay 0 ... 600 s (0010 SEC)
	SENSOCHECK	ON / OFF
	TEMPCHECK	ON / OFF
Relay 1		
RL1	LIMIT ALARM WASH	The following submenu depends on the selected setting.
LM1	CHANNEL	COND / TMP
	FUNCTION	Lo LEVEL / Hi LEVEL
	CONTACT	N/O / N/C
	LEVEL	000.0 mS/cm
	HYSTERESIS	005.0 mS/cm 0 ... 50 % full scale
	DELAYTIME	0010 SEC 0000 ... 9999 s
AL1	TRIGGER	FAIL / FACE
	CONTACT	N/O / N/C
WS1	CYCLE TIME	000.0 h / 0.0 ... 999.9 h
	DURATION	0060 SEC / 0.0 ... 1999 s
	RELAX TIME	0030 SEC / 0000 ... 1999 s
	CONTACT	N/O / N/C
Relay 2 Default LIMIT / FUNCTION: Hi LEVEL (other settings like Relay 1)		
Time/date		
CLK	FORMAT	24 h / 12 h
	24 h	hh:mm
	12 h	hh:mm (AM / PM) 00 ... 12:59 AM / 1 ... 11:59 PM
	DAY / MONTH	dd.mm
	YEAR	2000 ... 2099
Measuring points (TAG / GROUP)		
TAG	The entries are made in the text line.	A...Z, 0...9, - + < > ? / @
GROUP	The entries are made in the text line.	0000...9999 (0000)

Configuring the Sensor

Device Type: Cond / Condi

The device type is automatically selected upon first start-up. In the SERVICE menu you can change the device type. Afterwards, you must select the corresponding calibration mode in the CONF menu.

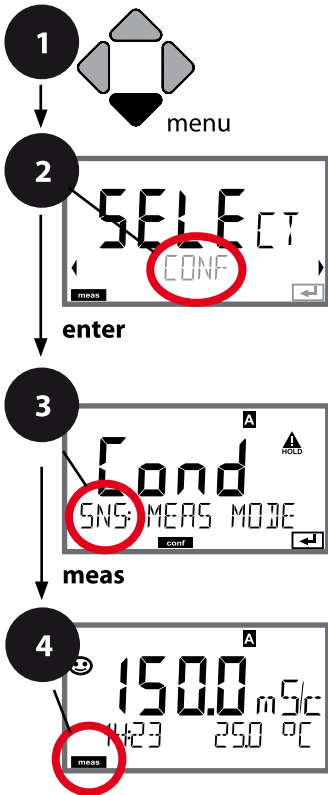

- 1 Press **menu** key.
- 2 Select **CONF** using ◀ ▶, press **enter**.
- 3 Select **SENSOR** menu using ◀ ▶ keys, press **enter**.
All items of this menu group are indicated by the "SNS:" code.
Press **enter** to select menu, edit using arrow keys (see next page).
Confirm (and proceed) by pressing **enter**.
- 4 Exit: Press **meas** key until the [meas] mode indicator is displayed.

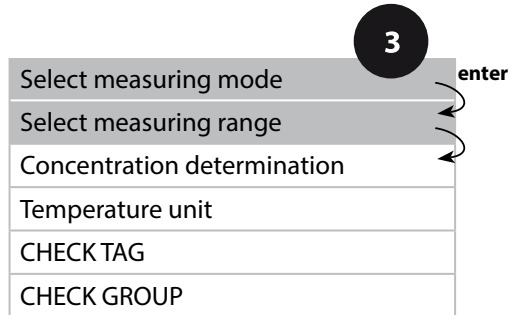

Configuring the Sensor

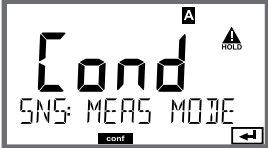
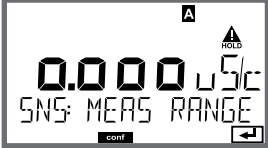
Menu item	Action	Choices
<p>Select measuring mode</p> 	<p>Select desired mode using ▲ ▼ keys.</p> <p>Press enter to confirm.</p>	<p>Cond Conc % Sal ‰</p>
<p>Select measuring range</p> 	<p>For cond measurement only</p> <p>Select desired measuring range using ▲ ▼ keys.</p> <p>Press enter to confirm.</p>	<p>x.xxx μS/cm, xx.xx μS/cm xxx.x μS/cm, xxxx μS/cm x.xxx mS/cm, xx.xx mS/cm xxx.x mS/cm, x.xxx S/m xx.xx S/m, xx.xx MΩ</p>

Configuring the Sensor

Concentration Determination, Temperature Unit

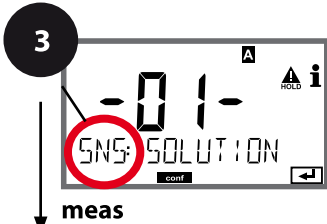
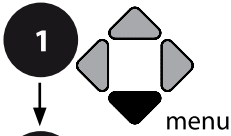

- 1 Press **menu** key.
- 2 Select **CONF** using ◀ ▶, press **enter**.
- 3 Select **SENSOR** menu using ◀ ▶ keys, press **enter**.
All items of this menu group are indicated by the "SNS:" code.
Press **enter** to select menu, edit using arrow keys (see next page).
Confirm (and proceed) by pressing **enter**.
- 4 Exit: Press **meas** key until the [meas] mode indicator is displayed.

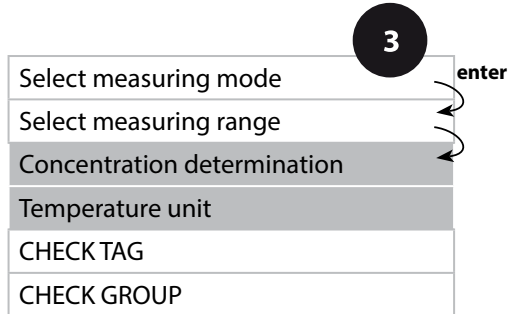

Configuring the Sensor

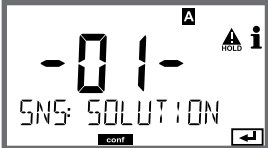
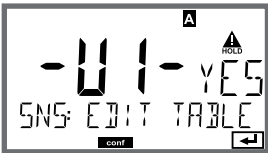
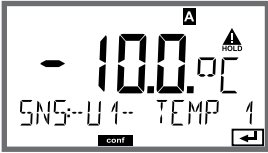
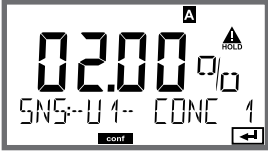
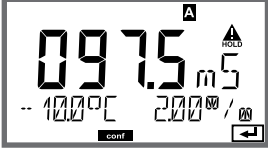
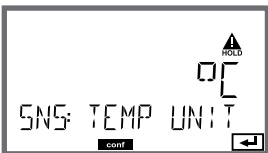
Menu item	Action	Choices
<p>Concentration determination</p> 	<p>For conc measurement only</p> <p>Select desired concentration solution using \blacktriangle \blacktriangledown keys. Press enter to confirm.</p>	<p>-01- (NaCl), -02- (HCl), -03- (NaOH), -04- (H₂SO₄), -05- (HNO₃), -06- (H₂SO₄), -07- (HCl), -08- (HNO₃), -09- (H₂SO₄), -10- (NaOH), -11- (H₂SO₄•SO₃) (Oleum), -U1-</p>
<p>-U1-: Specifying a Concentration Solution for Conductivity Measurement</p> <p>To specify a custom solution, 5 concentration values are entered in a matrix together with 5 temperature values 1 ... 5. First enter the 5 temperature values, then the corresponding conductivity values for each of the concentrations 1 ... 5. These solutions are then available as "U1" in addition to the default standard solutions.</p>		
	<p>Press enter to confirm</p>	
	<p>Use the arrow keys \blacktriangle \blacktriangledown \blacktriangleleft \blacktriangleright to enter temperature values 1 ... 5. Confirm with enter</p>	<p>Input range: -50...250 °C / -58...482 °F</p>
	<p>Use the arrow keys \blacktriangle \blacktriangledown \blacktriangleleft \blacktriangleright to enter concentration value 1. Confirm with enter</p>	
	<p>For concentration value 1: Use the arrow keys \blacktriangle \blacktriangledown \blacktriangleleft \blacktriangleright to enter conductivity values for temperatures 1 ... 5. Confirm with enter</p>	
<p>Temperature unit</p> 	<p>Select °C or °F using \blacktriangle \blacktriangledown keys. Press enter to confirm.</p>	<p>°C / °F</p>

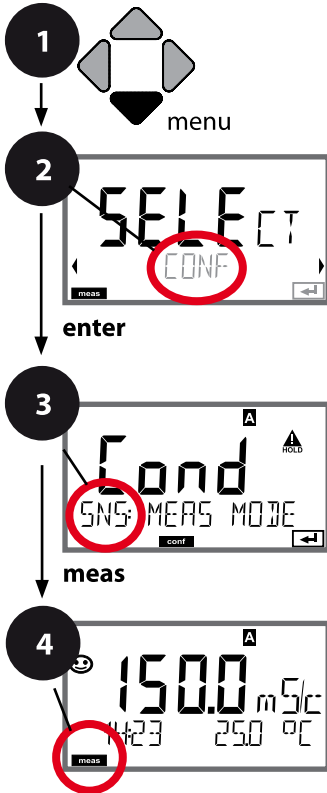

Configuring the Sensor

Sensor Verification (TAG, GROUP)

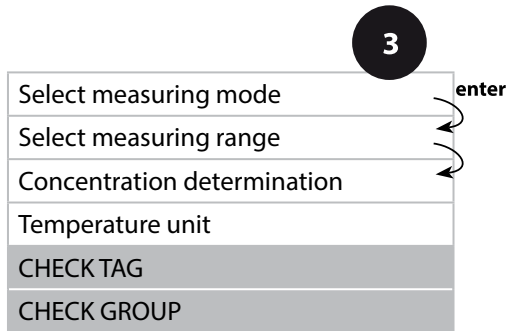

- 1 Press **menu** key.
- 2 Select **CONF** using ◀ ▶, press **enter**.
- 3 Select **SENSOR** menu using ◀ ▶ keys, press **enter**.
All items of this menu group are indicated by the "SNS:" code.
Press **enter** to select menu, edit using arrow keys (see next page). Confirm (and proceed) by pressing **enter**.
- 4 Exit: Press **meas** key until the [meas] mode indicator is displayed.



Menu item	Action	Choices
<p>TAG</p> 	<p>Select ON or OFF using ▲ ▼ keys. Press enter to confirm.</p> <p>When switched on, the entry for "TAG" in the Memosens sensor is compared to the entry in the analyzer. If the entries differ, a message will be generated.</p>	ON/OFF
<p>GROUP</p> 	<p>Select ON or OFF using ▲ ▼ keys. Press enter to confirm.</p> <p>Function as described above</p>	ON/OFF

Sensor Verification (TAG, GROUP)

When Memosens sensors are calibrated in the lab, it is often useful and sometimes even mandatory that these sensors will be operated again at the same measuring points or at a defined group of measuring points. To ensure this, you can save the respective measuring point (TAG) or group of measuring points (GROUP) in the sensor. TAG and GROUP can be specified by the calibration tool or automatically entered by the transmitter. When connecting an MS sensor to the transmitter, it can be checked if the sensor contains the correct TAG or belongs to the correct GROUP. If not, a message will be generated and Sensoface gets "sad". The "sad" Sensoface icon can also be signaled by a 22 mA error current. Sensor verification can be switched on in the Configuration in two steps as TAG and GROUP if required.

When no measuring point or group of measuring points is saved in the sensor, e.g., when using a new sensor, Stratos enters its own TAG and GROUP. When sensor verification is switched off, Stratos always enters its own measuring point and group. A possibly existing TAG/GROUP will be overwritten.

Configuring the Current Output

Output Current: Range, Current Start/End



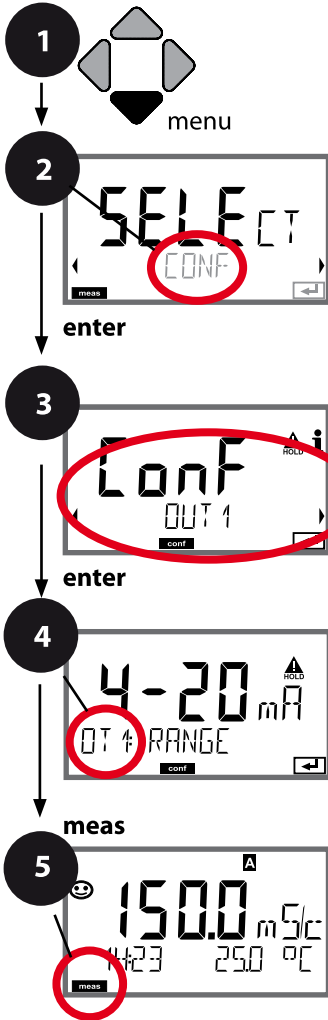

(Example: current output 1, device type Cond)

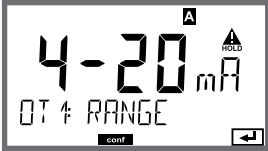

- 1 Press **menu** key.
- 2 Select **CONF** using ◀ ▶, press **enter**.
- 3 Select **OUT1** menu using ◀ ▶ keys, press **enter**.
- 4 All items of this menu group are indicated by the "OT1:" code. Press **enter** to select menu, edit using arrow keys (see next page). Confirm (and proceed) by pressing **enter**.
- 5 Exit: Press **meas** key until the [meas] mode indicator is displayed.

4	Current range	enter
	Process variable	enter
	Current start	enter
	Current end	
	Time averaging filter	
	Output current during error message	
	Output current for Sensoface message	
	Output current during HOLD	
	Output current for HOLD FIX	

Configuring the Current Output

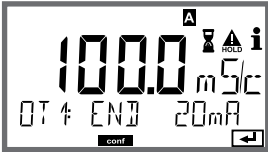
Menu item	Action	Choices
<p>Current range</p> 	<p>Select 4-20 mA or 0-20 mA range using \blacktriangle \blacktriangledown keys.</p> <p>Press enter to confirm.</p>	<p>4-20 mA / 0-20 mA</p>
<p>Process variable</p> 	<p>Select using \blacktriangle \blacktriangledown keys.</p> <p>Cond: Conductivity TMP: Temperature</p> <p>Press enter to confirm.</p> <p>Then select characteristic (LIN/biLIN/LOG).</p>	<p>Cond/TMP</p> 
<p>Current start</p> 	<p>Modify digit using \blacktriangle \blacktriangledown keys, select next digit using \blacktriangleleft \blacktriangleright keys.</p> <p>Press enter to confirm.</p>	<p>Entered value applies to selected process variable/range.</p> <p>If the adjusted range is exceeded, the device automatically switches to the next higher range (Autorange)</p>
<p>Current end</p> 	<p>Enter value using \blacktriangle \blacktriangledown \blacktriangleleft \blacktriangleright keys.</p> <p>Press enter to confirm.</p>	<p>Entered value applies to selected process variable/range.</p> <p>If the adjusted range is exceeded, the device automatically switches to the next higher range (Autorange)</p>

Assignment of measured values: Current start and current end

Example 1: Measuring range 0 ... 200 mS/cm

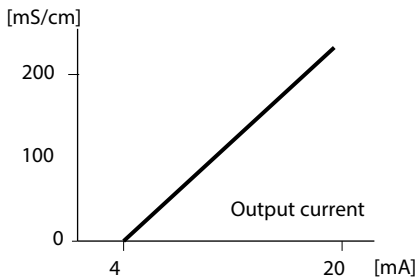

Example 2: Measuring range 100 ... 200 mS/cm
Advantage: Higher resolution in range of interest

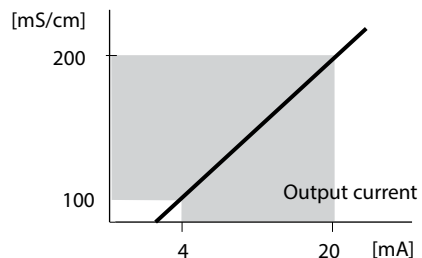

Configuring the Current Output

Output Current: Curve

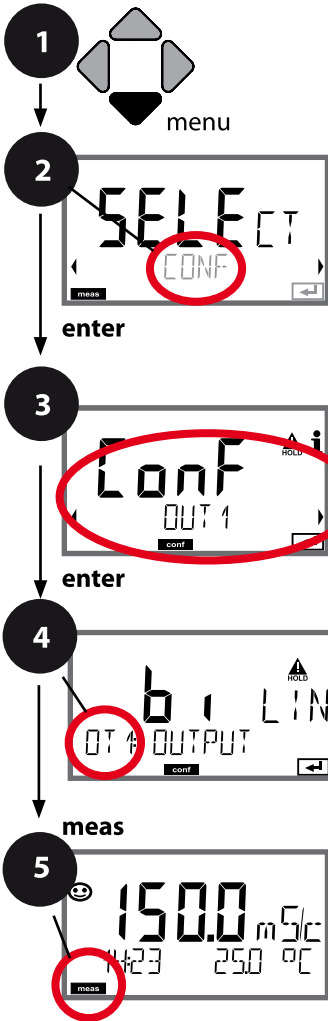

Example: Current Output 1



- 1 Press **menu** key.
- 2 Select **CONF** using ◀ ▶, press **enter**.
- 3 Select **OUT1** menu using ◀ ▶ keys, press **enter**.
- 4 All items of this menu group are indicated by the "OT1:" code. Press **enter** to select menu, edit using arrow keys (see next page). Confirm (and proceed) by pressing **enter**.
- 5 Exit: Press **meas** key until the [meas] mode indicator is displayed.

Current range	enter
Process variable	
LIN/biLIN/LOG output	
Current start	
Current end	
Bilinear: Vertex X	
Bilinear: Vertex Y	
Time averaging filter	
Output current during error message	
Output current for Sensoface message	
Output current during HOLD	
Output current for HOLD FIX	

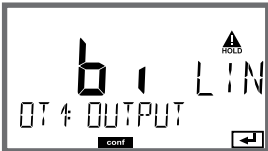
Configuring the Current Output

Menu item	Action	Choices
Output current curve 	Select using \uparrow \downarrow keys, confirm by pressing enter	LIN Linear characteristic biLIN Bilinear curve LOG Logarithmic curve
Current start and current end 	Enter value using \uparrow \downarrow \leftarrow \rightarrow keys. Press enter to confirm.	Entered value applies to selected process variable/range. If the adjusted range is exceeded, the device automatically switches to the next higher range (Autorange)
Bilinear curve: Vertex X/Y 	Enter value using \uparrow \downarrow \leftarrow \rightarrow keys. Press enter to confirm.	Entered value applies to selected vertex of bilinear curve "Corner X" (process variable) and "Corner Y" (output current) – see figure below.

Vertex of bilinear curve

Output current

[mA]

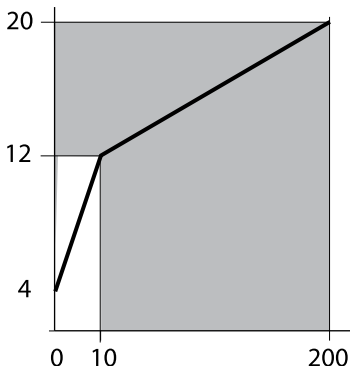

Example:

Current range 4 ... 20 mA

Current start: 0 $\mu\text{S/cm}$

Current end: 200 $\mu\text{S/cm}$

Vertex:

"CORNER X": 10 $\mu\text{S/cm}$ (process variable)

"CORNER Y": 12 mA (output current)

Result: The output current change in the range 0 ... 10 $\mu\text{S/cm}$ is much greater than in the range 10 ... 200 $\mu\text{S/cm}$.

Process variable

[$\mu\text{S/cm}$]

Configuring the Current Output

Output Current: Logarithmic Curve

Nonlinear output current characteristic: allows measurements over several decades, e.g., measuring very low values with a high resolution and high values with a low resolution.

Parameters required: Start and end value

Possible start and end values

The start value must be at least one decade lower than the end value. Start value and end value must be specified in the same units (either in $\mu\text{S/cm}$ or in S/m , see listing):

1.0 $\mu\text{S/cm}$	
10.0 $\mu\text{S/cm}$	0.001 S/cm
100.0 $\mu\text{S/cm}$	0.01 S/cm
1.0 mS/cm	0.1 S/cm
10.0 mS/cm	1.0 S/cm
100.0 mS/cm	10.0 S/cm
1000 mS/cm	100 S/cm

The start value

is the next decade value below the lowest measured value.

The end value

is the next decade value above the highest measured value.

The number of decades results from:



$$\text{Number of decades} = \log(\text{end value}) - \log(\text{start value})$$

The output current value is defined as follows:

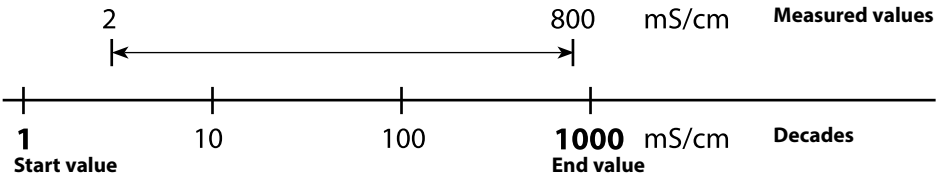
$$\text{Output current} = 16 \text{ mA} * \frac{\log(\text{measured value}) - \log(\text{start value})}{\text{Number of decades}} + 4 \text{ mA}$$

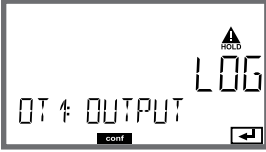

Configuring the Current Output

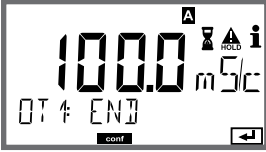
Menu item	Action	Choices
Logarithmic curve Output current 	Select using \uparrow \downarrow keys, confirm by pressing enter	LOG Logarithmic curve biLIN Bilinear curve LIN Linear characteristic
Start value 	Enter value using \uparrow \downarrow \leftarrow \rightarrow keys. Press enter to confirm.	Start value of logarithmic output curve
End value 	Enter value using \uparrow \downarrow \leftarrow \rightarrow keys. Press enter to confirm.	End value of logarithmic output curve

Possible start and end values for the logarithmic curve

S/cm:

1.0 μ S/cm, 10.0 μ S/cm, 100.0 μ S/cm,
 1.0 mS/cm, 10.0 mS/cm, 100.0 mS/cm, 1000 mS/cm

S/m:

0.001 S/m, 0.01 S/m, 0.1 S/m, 1.0 S/m, 10.0 S/m, 100 S/m

Configuring the Current Output

Output Current: Time Averaging Filter

Example: Current Output 1



- 1 Press **menu** key.
- 2 Select **CONF** using ◀ ▶, press **enter**.
- 3 Select **OUT1** menu using ◀ ▶ keys, press **enter**.
- 4 All items of this menu group are indicated by the "OT1:" code. Press **enter** to select menu, edit using arrow keys (see next page). Confirm (and proceed) by pressing **enter**.
- 5 Exit: Press **meas** key until the [meas] mode indicator is displayed.

Current range	enter
Process variable	enter
Current start	enter
Current end	
Time averaging filter	
Output current during error message	
Output current for Sensoface message	
Output current during HOLD	
Output current for HOLD FIX	

Configuring the Current Output

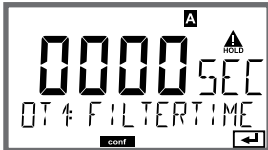
Menu item	Action	Choices
Time averaging filter 	Enter value using ▲ ▼ ◀ ▶ keys. Press enter to confirm.	0...120 SEC (0000 SEC)

Time averaging filter

To smoothen the current output, a low-pass filter with adjustable filter time constant can be switched on. When there is a jump at the input (100 %), the output level is at 63 % after the time interval has been reached. The time interval can be set from 0 to 120 sec. If the time interval is set to 0 sec, the current output directly follows the input.

Note:

The filter only acts on the current output, not on the display or the limit values! During HOLD the filter is not applied. This prevents a jump at the output.

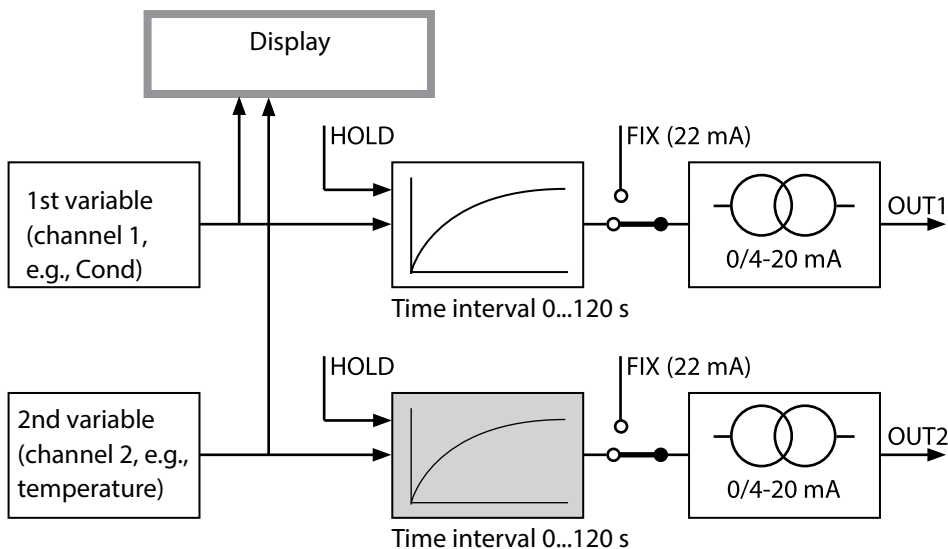

Configuring the Current Output

Output Current: Error and HOLD

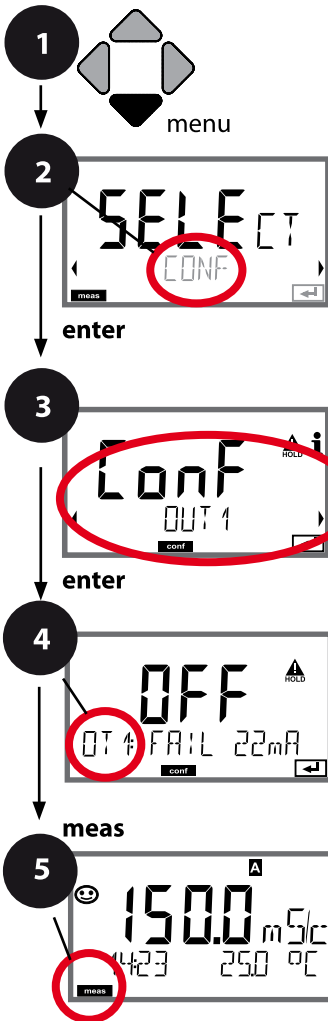

Example: Current output 1



- 1 Press **menu** key.
- 2 Select **CONF** using $\leftarrow \rightarrow$, press **enter**.
- 3 Select **OUT1** menu using $\leftarrow \rightarrow$ keys, press **enter**.
- 4 All items of this menu group are indicated by the "OT1:" code.
Press **enter** to select menu, edit using arrow keys (see next page). Confirm (and proceed) by pressing **enter**.
- 5 Exit: Press **meas** key until the [meas] mode indicator is displayed.

Current range
Process variable
Current start
Current end
Time averaging filter
Output current during error message
Output current for Sensoface message
Output current during HOLD
Output current for HOLD FIX

Configuring the Current Output

Menu item	Action	Choices
Output current during error message 	The output current can be set to 22 mA in the case of error messages or error messages. Select ON or OFF using \blacktriangle \blacktriangledown keys. Confirm by pressing enter	OFF / ON
Output current during Sensoface messages OT1: FACE 22 mA	The output current can be set to 22 mA in the case of Sensoface messages. Select ON or OFF using \blacktriangle \blacktriangledown keys. Confirm by pressing enter	OFF / ON
Output current during HOLD 	LAST: During HOLD the last measured value is maintained at the output. FIX: During HOLD a value (to be entered) is maintained at the output. Select using \blacktriangle \blacktriangledown Press enter to confirm.	LAST/FIX
Output current for HOLD IX 	Only with FIX selected: Enter current which is to flow at the output during HOLD Enter value using \blacktriangle \blacktriangledown \blacktriangleleft \blacktriangleright keys. Press enter to confirm.	00.00...22.00 mA (21.00 mA)

Output signal during HOLD:

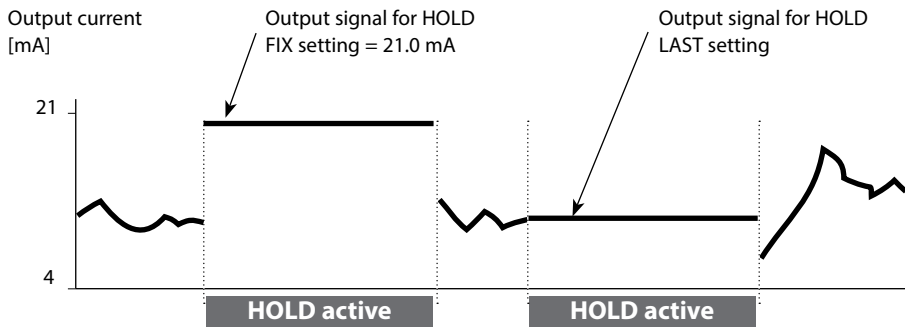

Configuring the Alarm

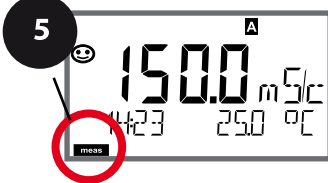
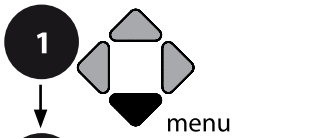

Alarm Delay, Sensocheck, Tempcheck

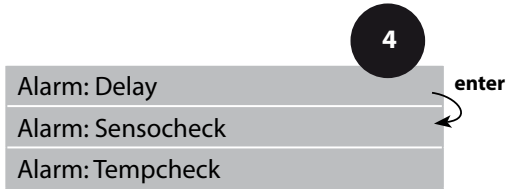

- 1 Press **menu** key.
- 2 Select **CONF** using ◀ ▶, press **enter**.
- 3 Select **ALARM** menu using ◀ ▶ keys, press **enter**.
- 4 All items of this menu group are indicated by the "ALA:" code. Press **enter** to select menu, edit using arrow keys (see next page). Confirm (and proceed) by pressing **enter**.
- 5 Exit: Press **meas** key until the [meas] mode indicator is displayed.



Configuring the Alarm

Menu item	Action	Choices
<p>Alarm delay</p> 	<p>Enter value using ▲ ▼ ◀ ▶ keys. Press enter to confirm.</p>	<p>0...600 SEC (10 SEC)</p>
<p>Sensocheck</p> 	<p>Select Sensocheck (continuous monitoring of sensor membrane and lines). Select ON or OFF using ▲ ▼ keys. Press enter to confirm. (At the same time, Sensoface is activated. With OFF, Sensoface is also switched off.)</p>	<p>ON/OFF</p>
<p>Tempcheck</p>	<p>To monitor the temperature probe with TC OFF selected: Select Tempcheck ON using ▲ ▼ keys. Press enter to confirm. Now, the temperature probe will be monitored.</p>	<p>ON/OFF</p>

The alarm delay time delays the color change of the display backlighting to red, the 22 mA signal (if configured), and the alarm contact switching.



Error messages can be signaled by a 22 mA output current. In addition, a relay contact (RELAY1 / RELAY2) can be configured as alarm contact.

Temperature Compensation

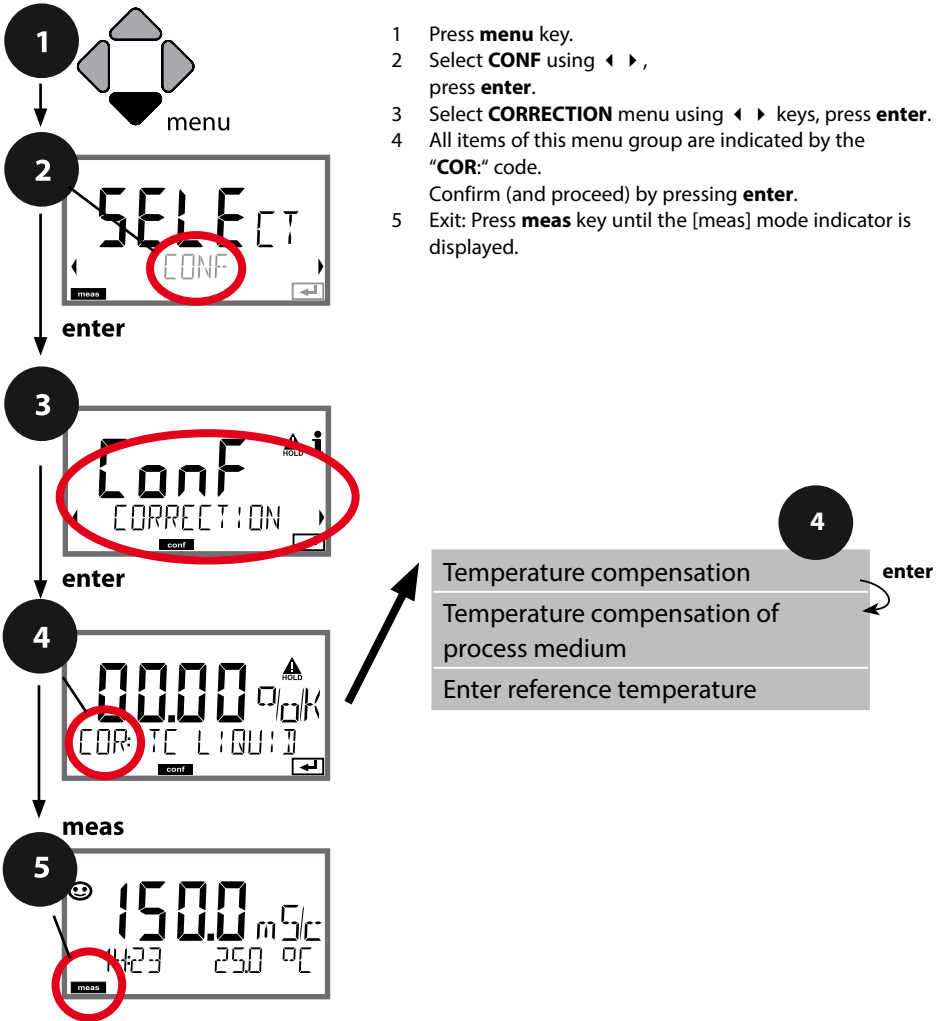
Selecting the compensation method

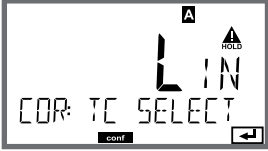

Temperature Compensation

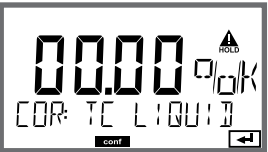
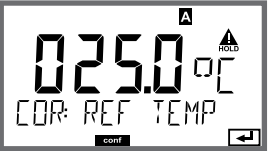
Menu item	Action	Choices
Temperature compensation	Select desired compensation using ▲ ▼ keys: OFF: Temperature compensation switched off	
	LIN: Linear temperature compensation with entry of temperature coefficient and reference temperature	
	nLF: Temperature compensation for natural waters to EN 27888	
	NaCl, HCL, NH3, NaOH: Ultrapure water with traces of impurity (0 ... +120 °C /+32 ... +248 °F)	
Temperature compensation of process medium	With linear compensation only: Step 1: Enter temperature compensation of the process medium.	
Enter reference temperature	Step 2: Enter reference temperature Enter value using ▲ ▼ ◀ ▶ keys Press enter to confirm. Permissible range 0 ... 199.9 °C	

Configuring the Relay Contacts





Relay Contacts: Function Assignment, Limit Values

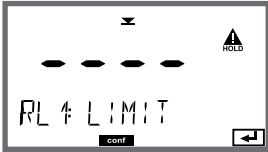

- 1 Press **menu** key.
- 2 Select **CONF** using **◀ ▶**, press **enter**.
- 3 Select **RELAY1** menu using **◀ ▶** keys, press **enter**.
Specify relay contact function: **LIMIT**.
- 4 All items of this menu group are indicated by the "LM1:" code.
Press **enter** to select menu, edit using arrow keys (see next page). Confirm (and proceed) by pressing **enter**.
- 5 Exit: Press **meas** key until the [meas] mode indicator is displayed.

4	Use of relays	enter
	Select process variable	enter
	Limit 1 switching characteristics (function)	enter
	Limit 1 contact type	
	Limit 1 setpoint	
	Limit 1 hysteresis	
	Limit 1 delay	

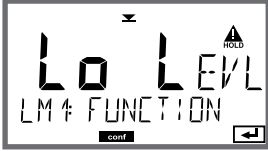
Configuring the Relay Contacts

Menu item	Action	Choices
<p>Use of relays</p> 	<p>Select in the text line using ▲ ▼ keys:</p> <ul style="list-style-type: none"> • Limit function (LIMITS) • Error message (ALARM) • Rinse contact (WASH) <p>Press enter to confirm.</p>	<p>LIMIT / ALARM / WASH</p> <p>Note: The following submenu depends on the selected setting.</p>
<p>Select process variable</p> 	<p>Select desired process variable using ▲ ▼ keys.</p> <p>Press enter to confirm.</p>	<p>Cond/TMP</p>
<p>Limit 1 function</p> 	<p>Select desired function using arrow keys.</p> <p>LoLevel: active if value falls below setpoint LoLevel: active if value exceeds setpoint</p> <p>Press enter to confirm.</p>	<p>Lo LEVL / Hi LEVL Limit 1 icon: ▼</p>
<p>Limit 1 contact response</p> 	<p>N/O: normally open contact N/C: normally closed contact</p> <p>Select using ▲ ▼ keys.</p> <p>Press enter to confirm.</p>	<p>N/O / N/C</p>
<p>Limit 1 setpoint</p> 	<p>Enter setpoint using ▲ ▼ ◀ ▶ keys.</p> <p>Press enter to confirm.</p>	<p>within measuring range</p>

Configuring the Relay Contacts

Relay Contacts: Limit Function, Hysteresis

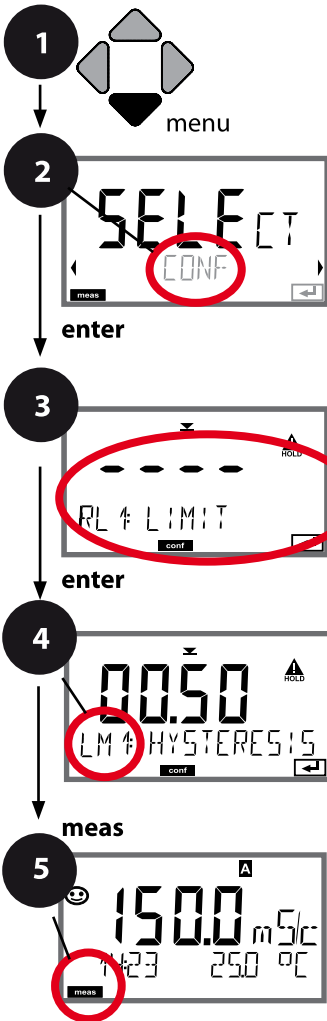

(Example: relay 1)



- 1 Press **menu** key.
- 2 Select **CONF** using ◀ ▶, press **enter**.
- 3 Select **RELAY1** menu using ◀ ▶ keys, press **enter**.
Specify relay contact function: **LIMIT**.
- 4 All items of this menu group are indicated by the "LM1:" code.
Press **enter** to select menu, edit using arrow keys (see next page).
Confirm (and proceed) by pressing **enter**.
- 5 Exit: Press **meas** key until the [meas] mode indicator is displayed.

Use of relays	enter
Select process variable	
Limit 1 switching characteristics (function)	enter
Limit 1 contact type	
Limit 1 setpoint	
Limit 1 hysteresis	
Limit 1 delay	

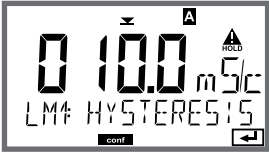
Configuring the Relay Contacts

Menu item	Action	Choices
<p>Limit 1 hysteresis</p> 	<p>Select hysteresis using ▲ ▼ ◀ ▶ keys.</p> <p>Press enter to confirm.</p>	<p>0...50 % full scale</p>
<p>Limit 1 delay</p> 	<p>The contact is activated with delay (deactivated without delay)</p> <p>Adjust delay using ▲ ▼ ▲ ▼ keys.</p> <p>Press enter to confirm.</p>	<p>0 ... 9999 SEC (0010 SEC)</p>

Application of Hysteresis:

Limit Lo

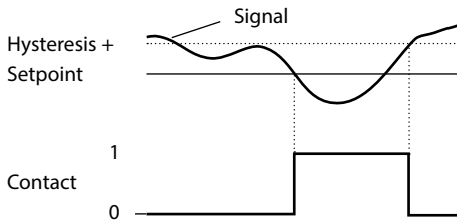

Limit Hi

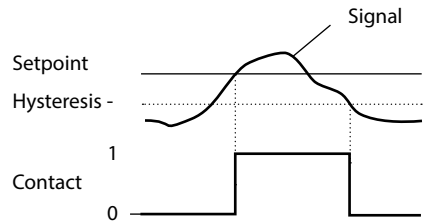

Configuring the Relay Contacts

Relay Contacts: Alarm



(Example: relay 1)



- 1 Press **menu** key.
- 2 Select **CONF** using ◀ ▶, press **enter**.
- 3 Select **RELAY1** menu using ◀ ▶ keys, press **enter**.
Specify relay contact function: **ALARM**.
- 4 All items of this menu group are indicated by the "AL1:" code.
Press **enter** to select menu, edit using arrow keys (see next page).
Confirm (and proceed) by pressing **enter**.
- 5 Exit: Press **meas** key until the [meas] mode indicator is displayed.



Configuring the Relay Contacts

Menu item	Action	Choices
<p>Alarm</p> 	<p>Select error messages (FAIL) or Sensoface messages (FACE) as trigger signal using ▲ ▼ ◀ ▶ keys.</p> <p>Press enter to confirm.</p>	<p>FAIL / FACE</p>
<p>Contact response</p> 	<p>N/O: normally open contact N/C: normally closed contact</p> <p>Select using ▲ ▼ keys.</p> <p>Press enter to confirm.</p>	<p>N/O / N/C</p>

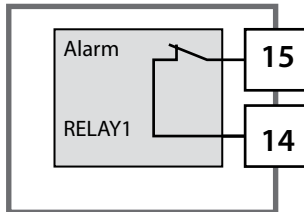

Alarm contact

A relay contact (RELAY1 / RELAY2) can be configured as alarm contact.

Configuring the Relay Contacts

Relay Contacts: Controlling a Rinsing Probe



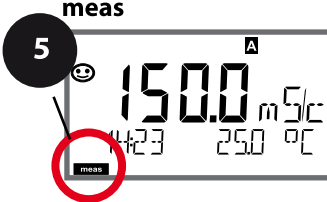
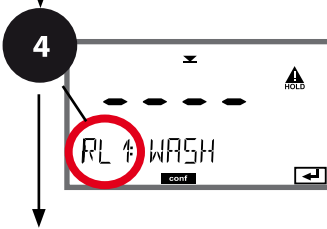
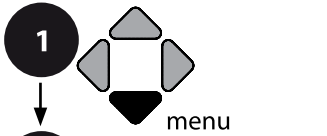

(Example: relay 1)

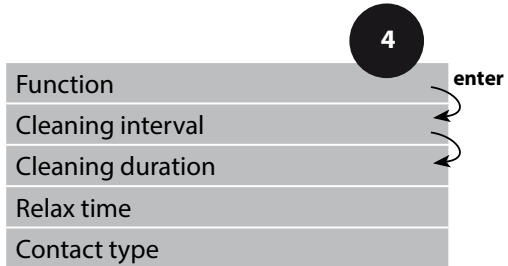

- 1 Press **menu** key.
- 2 Select **CONF** using ◀ ▶, press **enter**.
- 3 Select **RELAY1** menu using ◀ ▶ keys, press **enter**.
Specify relay contact function: **WASH**.
- 4 All items of this menu group are indicated by the "WS1:" code.
Press **enter** to select menu, edit using arrow keys (see next page).
Confirm (and proceed) by pressing **enter**.
- 5 Exit: Press **meas** key until the [meas] mode indicator is displayed.

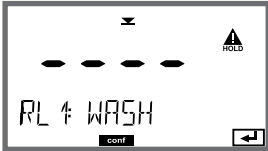

Configuring the Relay Contacts

Menu item	Action	Choices
<p>Use of relays</p> 	<p>Select in the text line using ▲ ▼ keys:</p> <ul style="list-style-type: none"> • Limit function (LIMITS) • Error message (ALARM) • Rinse contact (WASH) <p>Press enter to confirm.</p>	<p>LIMIT / ALARM / WASH</p> <p>Note: The following submenu depends on the selected setting.</p>
<p>Cleaning interval</p> 	<p>Adjust value using ▲ ▼ ◀ ▶ keys.</p> <p>Press enter to confirm.</p>	<p>0.0...999.9 h (000.0 h)</p>
<p>Cleaning duration</p> 	<p>Adjust value using ▲ ▼ ◀ ▶ keys.</p> <p>Press enter to confirm.</p> <p>Without figure: Relax time</p>	<p>0...9999 SEC (0060 SEC)</p> <p>Relax time: 0000 ... 1999 SEC (0030 SEC)</p>
<p>Contact type</p> 	<p>N/O: normally open contact N/C: normally closed contact</p> <p>Select using ▲ ▼ keys.</p> <p>Press enter to confirm.</p>	<p>N/O / N/C</p>

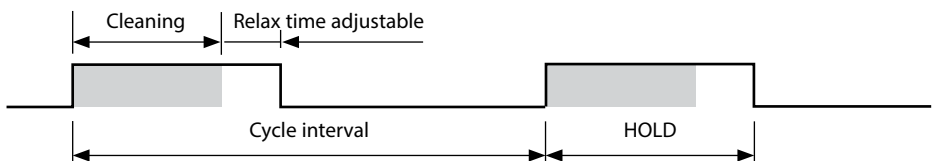

Protective Wiring of Relay Contacts

Relay contacts are subject to electrical erosion. Especially with inductive and capacitive loads, the service life of the contacts will be reduced. For suppression of sparks and arcing, components such as RC combinations, nonlinear resistors, series resistors and diodes should be used.

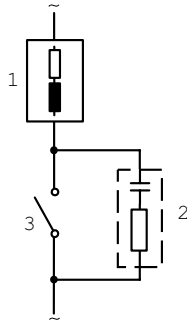
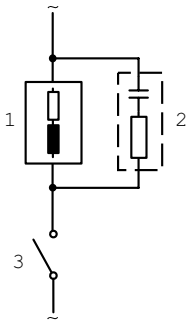

Typical AC applications with inductive load

- 1 Load
- 2 RC combination, e.g., RIFA PMR 209
Typical RC combinations for 230 V AC:
capacitor 0.1 μF / 630 V,
resistor 100 Ω / 1 W
- 3 Contact

Protective Wiring of Relay Contacts

Typical Protective Wiring Measures

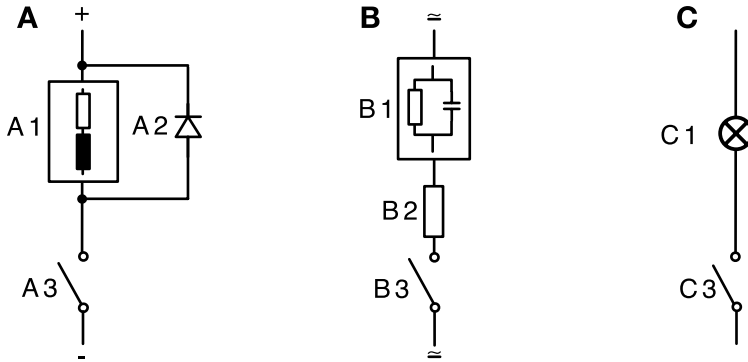

- A:** DC application with inductive load
- B:** AC/DC applications with capacitive load
- C:** Connection of incandescent lamps

- A1 Inductive load
- A2 Free-wheeling diode, e.g., 1N4007 (Observe polarity)
- A3 Contact
- B1 Capacitive load
- B1 Resistor, e.g., $8 \Omega / 1 \text{ W}$ at $24 \text{ V} / 0.3 \text{ A}$
- B3 Contact
- C1 Incandescent lamp, max $60 \text{ W} / 230 \text{ V}$, $30 \text{ W} / 115 \text{ V}$
- C3 Contact

NOTICE! Make sure that the maximum ratings of the relay contacts are not exceeded even during switching, see page 95.

Configuring the Time/Date

Time and Date, Measuring Point (TAG/GROUP)

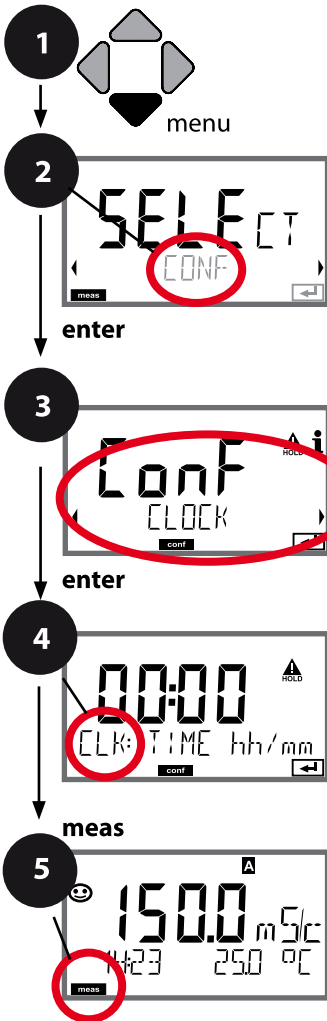

- 1 Press **menu** key.
- 2 Select **CONF** using **◀ ▶**, press **enter**.
- 3 Select **CLOCK** or **TAG** using **◀ ▶** keys, press **enter**.
- 4 All items of this menu group are indicated by the "CLK:" or "TAG" code.
Press **enter** to select menu, edit using arrow keys (see next page). Confirm (and proceed) by pressing **enter**.
- 5 Exit: Press **meas** key until the [meas] mode indicator is displayed.

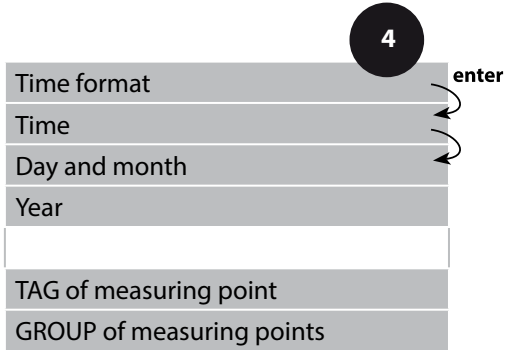

Time and Date

Control of the calibration and cleaning cycles is based on the time and date of the integrated real-time clock.

In measuring mode the time is shown in the lower display. When using digital sensors, the calibration data is written in the sensor head. In addition, the logbook entries (cf Diagnostics) are provided with a time stamp.

Note:

There is no automatic switchover from winter to summer time!
Be sure to manually adjust the time!

Sensor Verification (TAG, GROUP)

When Memosens sensors are calibrated in the lab, it is often useful and sometimes even mandatory that these sensors will be operated again at the same measuring points or at a defined group of measuring points. To ensure this, you can save the respective measuring point (TAG) or group of measuring points (GROUP) in the sensor. TAG and GROUP can be specified by the calibration tool or automatically entered by the transmitter. When connecting an MS sensor to the transmitter, it can be checked if the sensor contains the correct TAG or belongs to the correct GROUP. If not, a message will be generated and Sensoface gets "sad". The "sad" Sensoface icon can also be signaled by a 22 mA error current. Sensor verification can be switched on in the Configuration in two steps as TAG and GROUP if required.

When no measuring point or group of measuring points is saved in the sensor, e.g., when using a new sensor, Stratos enters its own TAG and GROUP. When sensor verification is switched off, Stratos always enters its own measuring point and group. A possibly existing TAG/GROUP will be overwritten.

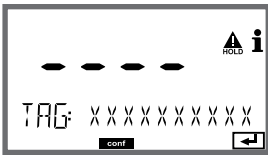
Menu item	Action	Choices
<p>TAG of measuring point</p> 	<p>In the lower display line you can enter a designation for the measuring point (TAG) and for a group of measuring points (GROUP) if applicable. Up to 32 digits are possible.</p> <p>By pressing meas (repeatedly) in the measuring mode you can view the tag number.</p> <p>Select character using ▲ ▼ keys, select next digit using ◀ ▶ keys. Press enter to confirm.</p>	<p>A...Z, 0...9, - + < > ? / @</p> <p>The first 10 characters are seen in the display without scrolling.</p>
<p>GROUP of measuring points</p>	<p>Select number using ▲ ▼ keys, select next digit using ◀ ▶ keys. Confirm by pressing enter</p>	<p>0000 ... 9999 (0000)</p>

Note:

- All calibration procedures must be performed by trained personnel. Incorrectly set parameters may go unnoticed, but change the measuring properties.

Calibration can be performed by:

- determining the cell constant (cell factor for toroidal sensors) with a known calibration solution
- entering the cell constant (cell factor for toroidal sensors)
- sampling (product calibration)
- zero calibration in air or with calibration solution (toroidal sensors)
- temperature probe adjustment

Selecting a Calibration Mode for 2-/4-Electrode Sensors

Calibration adapts the device to the individual sensor characteristics.

Access to calibration can be protected with a passcode (SERVICE menu).

First, you open the calibration menu and select the calibration mode:

CAL_SOL	Calibration with calibration solution
CAL_CELL	Calibration by input of cell constant
CAL_INSTALL	Calibration by input of an installation factor
P_CAL	Product calibration (calibration with sampling)
CAL_RTD	Temperature probe adjustment





Selecting a Calibration Mode for Toroidal Sensors



CAL_SOL	Calibration with calibration solution
CAL_CELL	Calibration by input of cell factor
CAL_INSTALL	Calibration by input of an installation factor
P_CAL	Product calibration (calibration with sampling)
CAL_ZERO	Zero calibration
CAL_RTD	Temperature probe adjustment

Calibration

Calibration with Calibration Solution

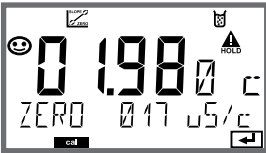
Input of temperature-corrected value of calibration solution with simultaneous display of cell constant (cell factor for toroidal sensors).

Display	Action	Remark
	<p>Select Calibration. Press enter to proceed. Select CAL_SOL calibration method. Press enter to proceed.</p>	
	<p>Ready for calibration. Hourglass blinks.</p>	<p>Display (3 sec) Now the device is in HOLD mode.</p>
	<p>Immerse sensor in calibration solution. Enter the temperature-corrected value of the calibration solution using the arrow keys (see table). Press enter to confirm.</p>	<p>Lower line: display of cell constant (cell factor) and temperature</p>
	<p>Contacting conductivity measurement (Cond) The determined cell constant is displayed. The "hourglass" icon is blinking. Proceed by pressing enter</p>	
	<p>Inductive conductivity measurement (CondI) The determined cell factor and zero point are displayed. The "hourglass" icon is blinking. Proceed by pressing enter</p>	

Display	Action	Remark
 <p>The display shows a large number '1265' with 'mS/cm' to its right. Below the number, 'MEAS' and 'REPE' are visible. There are several icons: a smiley face on the left, a triangle with 'i' on the right, and a 'cal' indicator at the bottom left. A right arrow icon is at the bottom right.</p>	<p>Display of selected process variable (here: mS/cm). Now the device is in HOLD mode: Reinstall the sensor and check whether the measurement is OK.</p> <p>MEAS exits calibration, REPEAT permits repetition.</p>	
 <p>The display shows '1265 mS/cm' at the top. Below it, 'GOOD BYE' is displayed between two sets of dashes. At the bottom left, 'meas' is shown in a small box. There are also a smiley face icon on the left and a triangle with 'i' icon on the right.</p>	<p>With MEAS selected: Press enter to exit calibration.</p>	<p>Display of conductivity and temperature, Senso-face is active.</p> <p>After end of calibration, the outputs remain in HOLD mode for a short time.</p> <p>After display of GOOD BYE, the device automatically returns to measuring mode.</p>





Note:

- Be sure to use known calibration solutions and the respective temperature-corrected conductivity values (see “Calibration Solutions” tables).
- Make sure that the temperature does not change during the calibration procedure.

Calibration

Calibration by Input of Cell Constant / Cell Factor

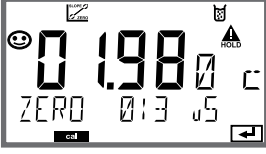



You can directly enter the value for the cell constant / cell factor of a sensor. The value must be known, eg, determined beforehand in the laboratory. The selected process variable and the temperature are displayed. This method is suitable for all process variables.

Display	Action	Remark
	Select Calibration. Press enter to proceed. Select CAL_CELL calibration method. Press enter to proceed.	
	Ready for calibration. Hourglass blinks.	Display (3 sec) Now the device is in HOLD mode.
	Enter cell constant / cell factor. Press enter to proceed.	The selected process variable and the temperature are displayed.
	The device shows the calculated values for the cell constant / cell factor and zero point (at 25 °C). Sensoface is active.	
	Use the arrow keys to select: • MEAS (exit) • REPEAT Press enter to proceed.	Exit: HOLD is deactivated after a short time.

Please refer to the specifications in the sensor manual for the nominal cell constant / cell factor. When measuring in a restricted space, the individual cell constant / cell factor must be determined.

Calibration by Input of an Installation Factor

When using a sensor in a tight space, you can enter an installation factor.

Display	Action	Remark
	<p>Select Calibration. Press enter to proceed. Select CAL_INSTALL calibration method. Press enter to proceed.</p>	
	<p>Ready for calibration. Hourglass blinks.</p>	<p>Display (3 sec) Now the device is in HOLD mode.</p>
	<p>Enter installation factor. Press enter to proceed.</p>	<p>The selected process variable and the temperature are displayed.</p>
	<p>Use the arrow keys to select:</p> <ul style="list-style-type: none"> • MEAS (end) • REPEAT <p>Press enter to proceed.</p>	<p>End: HOLD is deactivated after a short time.</p>

Calibration

Product Calibration

Calibration by sampling – for product calibration, the uncompensated conductivity ($\mu\text{S}/\text{cm}$, mS/cm , S/m) is used.

During product calibration the sensor remains in the process. The measurement process is only interrupted briefly.



Procedure:





1) The sample is measured in the lab or directly on the site using a portable meter. To ensure an exact calibration, the sample temperature must correspond to the measured process temperature.

During sampling the analyzer saves the currently measured value and then returns to measuring mode. Then, the “calibration” mode indicator blinks.

2) In the second step you enter the measured sample value in the device. From the difference between the stored measured value and entered sample value, the device calculates the new cell constant (the new cell factor for toroidal sensors).





If the sample is invalid, you can take over the value stored during sampling. In that case, the old calibration values are stored. Afterwards, you can start a new product calibration.

Display	Action	Remark
	Select Calibration. Press enter to proceed. Select P_CAL calibration method. Press enter to proceed.	
	Ready for calibration. Hourglass blinks.	Display (3 sec) Now the device is in HOLD mode.
	Take sample and save value. Press enter to proceed.	Now the sample can be measured in the lab.

Display	Action	Remark
	The device returns to measuring mode.	From the blinking CAL mode indicator, you see that product calibration has not been terminated.
	Product calibration step 2: When the sample value has been determined, open the product calibration once more	Display (3 sec) Now the device is in HOLD mode.
	The stored value is displayed (blinking) and can be overwritten with the lab value. Press enter to proceed.	
	Display of new cell constant / cell factor (based on 25°C). Sensoface is active. To exit calibration: Select MEAS, then enter	To repeat calibration: Select REPEAT, then enter
	End of calibration	After end of calibration, the outputs remain in HOLD mode for a short time.

Calibration

Temp Probe Adjustment

Display	Action	Remark
	<p>Select Calibration. Press enter to proceed. Select CAL_RTD calibration method. Press enter to proceed.</p>	<p>Wrong settings change the measurement properties!</p>
	<p>Measure the temperature of the process medium using an external thermometer.</p>	<p>Display (3 sec) Now the device is in HOLD mode.</p>
	<p>Enter the measured temperature value. Maximum difference: 10 K. Press enter to proceed.</p>	<p>Display of actual temperature (uncompensated) in the lower display.</p>
	<p>The corrected temperature value is displayed. Sensoface is active. To exit calibration: Select MEAS, then enter To repeat calibration: Select REPEAT, then enter</p>	<p>After end of calibration, the outputs remain in HOLD mode for a short time.</p>
	<p>After calibration is ended, the device will switch to measuring mode.</p>	

Calibrating Toroidal Sensors

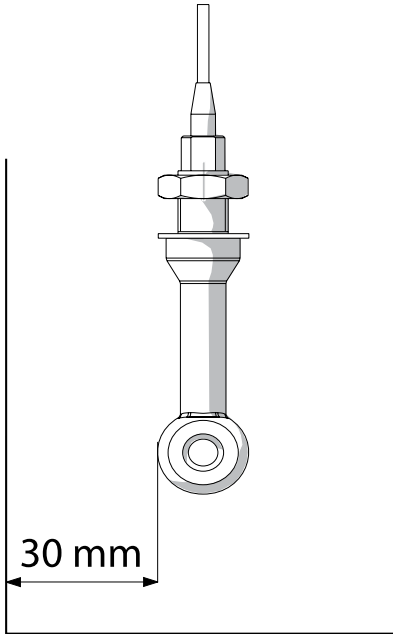





Note:



When the sensor is installed in a pipe/tank at a distance less than 30 mm from the wall, you should perform the calibration either by means of sampling (product calibration) with the sensor installed or in a suitable calibration beaker with dimensions and material corresponding to the process conditions.

Calibration

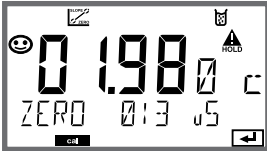
Zero Calibration

(Toroidal sensors)

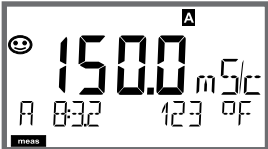
Display	Action	Remark
	Select Calibration. Press enter to proceed. Select CAL_ZERO calibration method. Press enter to proceed.	
	Ready for calibration. Hourglass blinks.	Display (3 sec) Now the device is in HOLD mode.
	Calibration in air Edit digits until the lower display indicates Zero Calibration in air (AIR-SET) for SE680-M and Memosens sensors: Press enter to start AIR-SET. When zero point and cell factor are displayed, press enter to confirm.	
	The device shows the cell factor (at 25 °C) and the zero point. Sensoface is active.	
	Use the arrow keys to select: • MEAS (exit) • REPEAT Press enter to proceed.	Exit: HOLD is deactivated after a short time.

Display	Remark
	<p>From the configuration or calibration menu, you can switch the device to measuring mode by pressing the meas key.</p> <p>In the measuring mode the upper display line shows the configured process variable (Cond, Conc or temperature), the lower display line shows the time and the second configured process variable (Cond, Conc or temperature). The [meas] mode indicator lights.</p> <p>Note:</p> <ul style="list-style-type: none"> • After prolonged power outage (> 5 days), the time display is replaced by dashes and cannot be used for processing. In that case, enter the correct time.
	<p>By pressing the meas key you can step through the different displays. When no key has been pressed for 60 sec, the device returns to the standard display, see “Display in Measuring Mode” on page 20.</p>
	<p>Further displays (each by pressing meas).</p> <ol style="list-style-type: none"> 1) Display of tag number (“TAG”) 2) Display of time and date (without figure)

Diagnostics

In the Diagnostics mode you can access the following menus without interrupting the measurement:





CALDATA	Viewing the calibration data
SENSOR	Viewing the sensor data
SELFTEST	Starting a device self-test
LOGBOOK	Viewing the logbook entries
MONITOR	Displaying currently measured values
VERSION	Displaying device type, software version, serial number

Access to diagnostics can be protected with a passcode (SERVICE menu).

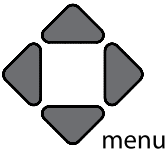
Note:

HOLD is not active during Diagnostics mode!

Action	Key	Remark
Activate diagnostics		Press menu key to call the selection menu. Select DIAG using ◀ ▶ keys, confirm by pressing enter
Select diagnostics option		Use ◀ ▶ keys to select from: CALDATA SENSOR SELFTEST LOGBOOK MONITOR VERSION See next pages for further proceeding.
Exit	meas	Exit by pressing meas .

Display	Menu item
	<p>Displaying the calibration data Select CALDATA using ◀ ▶, confirm by pressing enter. Use the ◀ ▶ keys to select the desired parameter from the bottom line of the display (LAST_CAL / CELL / ZERO / INSTALL). The selected parameter is shown in the upper display line.</p>
	<p>Press meas to return to measurement.</p>
	
	<p>Displaying the sensor data Manufacturer, type, serial number and last calibration date. In each case Sensoface is active.</p> <p>Display data using ◀ ▶ keys, return by pressing enter or meas.</p>

Display

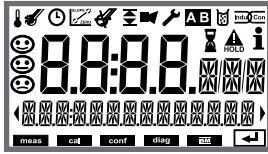



Menu item

Device self-test

(To abort, you can press **meas**.)

- 1 **Display test:** Display of all segments with changing background colors (white/green/red).
Proceed by pressing **enter**
- 2 **RAM test:** Hourglass blinks, then display of --PASS-- or --FAIL--
Proceed by pressing **enter**
- 3 **EEPROM test:** Hourglass blinks, then display of --PASS-- or --FAIL--
Proceed by pressing **enter**
- 4 **FLASH test:** Hourglass blinks, then display of --PASS-- or --FAIL--
Proceed by pressing **enter**

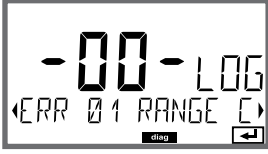
Display	Menu item
	<p>Displaying the logbook entries Select LOGBOOK using ◀ ▶, press enter to confirm.</p> <p>With the ▲ ▼ keys, you can scroll backwards and forwards through the logbook (entries -00-...-99-), -00- being the last entry.</p>
	<p>If the display is set to date/time, you can search for a particular date using the ▲ ▼ keys. Press ◀ ▶ to view the corresponding message text.</p>
	<p>If the display is set to the message text, you can search for a particular message using the ▲ ▼ keys. Press ◀ ▶ to display the date and time.</p> <p>Press meas to return to measurement.</p>

Display



Display examples:



Menu item

Displaying the currently measured values (sensor monitor)

Select MONITOR using ◀ ▶, press **enter** to confirm. Use the ◀ ▶ keys to select from the bottom line of the display.

The selected parameter is shown in the upper display line. Press **meas** to return to measurement.

Display of sensor operating time

Version

Display of **device type, software/hardware version** and **serial number** for all device components.

Use the ▲ ▼ keys to switch between software and hardware version.



Press **enter** to proceed to next device component.



In the Service mode you can access the following menus:

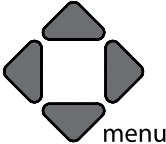

MONITOR	Displaying currently measured values
OUT1	Testing current output 1
OUT2	Testing current output 2
RELAIS	Testing the relay function
CODES	Assigning and editing passcodes
DEVICE TYPE	Selecting the device type (pH, Oxy, Cond)
DEFAULT	Resetting the device to factory settings

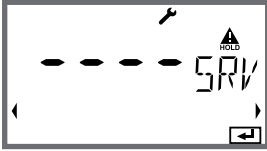
Note:

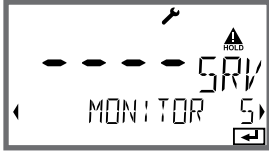
HOLD is active during Service mode!

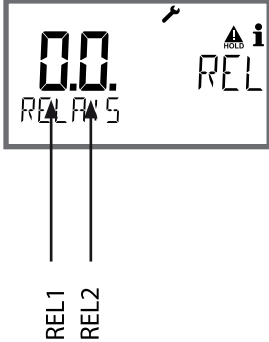
Action	Key/Display	Remark
Activate Service		Press menu key to call the selection menu. Select SERVICE using ◀ ▶ keys, press enter to confirm.
Passcode		Enter passcode "5555" for service mode using the ▲ ▼ ◀ ▶ keys. Press enter to confirm.
Display		In service mode the following icons are displayed: <ul style="list-style-type: none"> • HOLD triangle • Service (wrench)
Exit	meas	Exit by pressing meas .

Menu item	Remark
	<p>Displaying currently measured values (sensor monitor) with HOLD mode activated: Select MONITOR using ◀ ▶, press enter to confirm. Select the process variable in the bottom text line using ◀ ▶.</p> <p>The selected parameter is shown in the upper display line. As the device is in HOLD mode, you can perform validations using simulators without influencing the signal outputs.</p> <p>Hold meas depressed for longer than 2 sec to return to Service menu. Press meas once more to return to measurement.</p>
	<p>Specifying the current for outputs 1 and 2: Select OUT1 or OUT2 using the ◀ ▶ keys, press enter to confirm. Enter a valid current value for the respective output using ▲ ▼ ◀ ▶ keys. Confirm by pressing enter.</p> <p>For checking purposes, the actual output current is shown in the bottom right corner of the display. Exit by pressing enter or meas.</p>
	<p>Relay test (manual test of contacts): Select RELAIS using ◀ ▶, press enter to confirm. Now the status of the relays is "frozen". The 2 digits of the main display represent the respective states (from left to right: REL1, REL2). The selected digit blinks. Select one of the relays using the ◀ ▶ keys, close (1) or open (0) using the ▲ ▼ keys. Exit by pressing enter. The relays will be re-set corresponding to the measured value.</p> <p>Press meas to return to measurement.</p>

Menu item	Remark
	<p>Setting the passcodes: In the "SERVICE - CODES" menu you can assign passcodes to DIAG, HOLD, CAL, CONF and SERVICE modes (Service preset to 5555). When you have lost the Service passcode, you have to request an "Ambulance TAN" from the manufacturer specifying the serial number and hardware version of your device. To enter the "Ambulance TAN", call the Service function and enter passcode 7321. After correct input of the ambulance TAN the device signals "PASS" for 4 sec and resets the Service passcode to 5555.</p>
	<p>Reset to factory settings: In the "SERVICE - DEFAULT" menu you can reset the device to factory settings. NOTICE! After a reset to factory setting the device must be reconfigured completely, including the sensor parameters!</p>

Operating Error!





Power Disruption while Loading the Process Variable

In very rare cases it seems that the analyzer cannot be operated because it remains in "Firmware Update" mode – indicated by the --FIRMW UPDATE-- message. This occurs when the power is disrupted while the process variable is loaded.



Follow the instructions below to fix the error.

Action	Key/Display	Remark
Device start		If the power supply is disrupted while the process variable is loaded (e.g., during initial start-up or when changing the process variable), the following can occur:
Reconnecting the power supply		After the power supply has been reconnected, the analyzer starts and then remains in --FIRMW UPDATE-- mode. If this occurs, disconnect the power supply.
Restoring the factory settings		Press the ▲ ▼ keys simultaneously and hold them depressed while the analyzer is reconnected to the power supply.
Device start		Release the keys when the display shows LOADING BASE. The analyzer will restart with the BASE software when 100 % is reached.

Action	Key/Display	Remark
Searching for the process variable		Then the analyzer searches for a measuring module or Memosens sensor.
Loading the process variable, automatic		When a module or a sensor has been found, the loading progress is shown in percentages.
Loading the process variable, manual		If neither module nor sensor are found, the display shows DEVICE TYPE. The selected process variable blinks. You can modify it using the ▲ ▼ keys. Press enter to load the process variable displayed.
Loading ...		Make sure that the power supply is not interrupted before the process variable is fully loaded (100%) .

Error Messages

Error	Info text (is displayed in case of fault when the Info key is pressed)	Problem Possible causes
ERR 99	DEVICE FAILURE	Error in factory settings EEPROM or RAM defective This error message only occurs in the case of a total defect. The device must be repaired and recalibrated at the factory.
ERR 98	CONFIGURATION ERROR	Error in configuration or calibration data Configuration or calibration data defective; completely reconfigure and recalibrate the device.
ERR 95	SYSTEM ERROR	System error Restart required. If error still persists, send in the device for repair.
ERR 01	NO SENSOR	Sensor error Device type not assigned Defective sensor Sensor not connected Break in sensor cable
ERR 02	WRONG SENSOR	Wrong sensor Replace the sensor.
ERR 04	SENSOR FAILURE	Failure in sensor Replace the sensor.
ERR 05	CAL DATA	Error in cal data
ERR 10	CONDUCTANCE TOO HIGH	Display range exceeded Conductivity: Conductance > 3500 mS
ERR 11	RANGE	Display range violation
ERR 13	TEMPERATURE RANGE	Temperature range exceeded Connect the sensor, check the sensor cable and replace if necessary, check the sensor connection, adjust the parameter settings.

Error	Info text (is displayed in case of fault when the Info key is pressed)	Problem Possible causes
ERR 60	OUTPUT LOAD	Load error Check the current loop, deactivate unused current outputs.
ERR 61	OUTPUT 1 TOO LOW	Output current 1 < 0 (3.8) mA
ERR 62	OUTPUT 1 TOO HIGH	Output current 1 > 20.5 mA
ERR 63	OUTPUT 2 TOO LOW	Output current 2 < 0 (3.8) mA
ERR 64	OUTPUT 2 TOO HIGH	Output current 2 > 20.5 mA

Sensoface messages:

Cell factor monitoring	SENSOR CELL FACTOR CALIBRATE OR CHANGE SENSOR
Table monitoring (TC/Conc/Sal/USP)	OUT OF INTERNAL TABLE
Zero point monitoring	SENSOR ZERO CALIBRATE OR CHANGE SENSOR
Cell factor / zero point monitoring	SENSOR ZERO/CELL FACTOR CALIBRATE OR CHANGE SENSOR
Sensor TAG does not correspond to device entry.	WRONG SENSOR TAG
Sensor GROUP does not correspond to device entry.	WRONG SENSOR GROUP xxxx

Sensocheck and Sensoface

Sensocheck, Sensoface Sensor Monitoring



Sensocheck continuously monitors the sensor and its wiring.



The three Sensoface indicators provide information on required maintenance of the sensor. Additional icons refer to the error cause.



Pressing the **info** key shows an information text.

Note:

The worsening of a Sensoface criterion leads to the devaluation of the Sensoface indicator (Smiley gets “sad”). An improvement of the Sensoface indicator can only take place after calibration or removal of the sensor defect.

Sensoface message

The Sensocheck message is also output as error message Err 15.

The alarm contact is active, the display backlighting turns red, output current OUT is set to 22 mA (when configured correspondingly).

All other Sensoface message can be output via a contact (relay contacts, alarm --> “FACE”).

Disabling Sensocheck and Sensoface

Sensocheck can be switched off in the configuration menu (then Sensoface is also disabled).

Exception:

After a calibration, a smiley is always displayed for confirmation.























Disposal

Local codes and regulations must be observed when disposing of the product.



Returns

If required, send the product in a clean condition and securely packed to your local contact. See www.knick.de.

Operating States

Operating status	OUT 1	OUT 2	REL 1/2	Time out
Measure				-
DIAG				60 s
CAL				No
CONF				20 min
SERVICE				20 min
SERVICE OUT 1				20 min
SERVICE OUT 2				20 min
SERVICE RELAYS				20 min
Cleaning function				No
HOLD				No

Explanation:

-  as configured (Last/Fix or Last/Off)
-  active
-  manual

Devices

Stratos MS A405N

Order No.

A405N

Mounting accessories

Pipe-mount kit

ZU0274

Panel-mount kit

ZU0738

Protective hood

ZU0737

M12 socket for sensor connection
with Memosens cable / M12 connector

ZU0860

Up-to-date information:

www.knick.de

Phone: +49 30 80191-0

Fax: +49 30 80191-200

Email: info@knick.de

Specifications

COND input	Memosens (terminals 1 ... 4)	
Data In/Out	Asynchronous interface, RS-485, 9600/19200 Bd	
Power supply	Terminal 1: +3.08 V/10 mA, Ri < 1 Ω, short-circuit-proof	
Display ranges	Conductivity	0.000 ... 9.999 μS/cm 00.00 ... 99.99 μS/cm 000.0 ... 999.9 μS/cm 0000 ... 9999 μS/cm 0.000 ... 9.999 mS/cm 00.00 ... 99.99 mS/cm 000.0 ... 999.9 mS/cm 0.000 ... 9.999 S/cm 00.00 ... 99.99 S/cm
	Resistivity	00.00 ... 99.99 MΩ · cm
	Concentration	0.00 ... 100 %
	Temperature	-20.0 ... 150.0 °C / -4.0 ... 302.0 °F
	Salinity	0.0 ... 45.0 ‰ (0 ... 35 °C / 32 ... 86 °F)
	Response time (T90)	approx. 1 s
Measurement error ¹⁾	Depending on Memosens	
Temperature compensation * (Reference temp. 25 °C / 77 °F)	(OFF)	Without
	(LIN)	Linear characteristic 00.00 ... 19.99 %/K
	(NLF)	Natural waters to EN 27888
	(NACL)	Ultrapure water with NaCl traces (0 ... 120 °C / 32 ... 248 °F)
	(HCL)	Ultrapure water with HCl traces (0 ... 120 °C / 32 ... 248 °F)
	(NH3)	Ultrapure water with NH ₃ traces (0 ... 120 °C / 32 ... 248 °F)
	(NAOH)	Ultrapure water with NaOH traces (0 ... 120 °C / 32 ... 248 °F)

^{*)} user-defined

¹⁾ at normal operating conditions

Concentration determination	-01- NaCl	0 – 26 wt% (0 °C /32 °F) ... 0 – 28 wt% (100 °C/212 °F)
	-02- HCl	0 – 18 wt% (-20 °C /-4 °F) ... 0 – 18 wt% (50 °C/122 °F)
	-03- NaOH	0 – 13 wt% (0 °C /32 °F) ... 0 – 24 wt% (100 °C/212 °F)
	-04- H ₂ SO ₄	0 – 26 wt% (-17 °C/1.4 °F)...0 – 37 wt% (110 °C/230 °F)
	-05- HNO ₃	0 – 30 wt% (-20 °C /-4 °F) ... 0 – 30 wt% (50 °C/122 °F)
	-06- H ₂ SO ₄	94 – 99 wt% (17 °C/1.4 °F)...89 – 99 wt% (115 °C/239 °F)
	-07- HCl	22 – 39 wt% (-20 °C/-4 °F)...22 – 39 wt% (50 °C/122 °F)
	-08- HNO ₃	35 – 96 wt% (-20 °C/-4 °F)...35 – 96 wt% (50 °C/122 °F)
	-09- H ₂ SO ₄	28 – 88 wt% (17 °C/1.4 °F)...39 – 88 wt% (115 °C/239 °F)
	-10- NaOH	15 – 50 wt% (0 °C/32 °F)...35 – 50 wt% (100 °C/212 °F)
	-11- H ₂ SO ₄ •SO ₃ (oleum)	13 – 45 wt% (0 °C /32 °F) ... 13 – 45 wt% (120 °C/248 °F)
-U1-	Specifiable concentration table	

Sensor standardization	Input of cell constant/cell factor with simultaneous display of selected process variable and temperature
	Input of conductivity of calibration solution with simultaneous display of cell constant/cell factor and temperature
	Input of an installation factor
	Product calibration for conductivity
	Temperature probe adjustment
	Zero calibration (CondI)

Sensocheck	Polarization detection
-------------------	------------------------

Delay	Approx. 30 s
-------	--------------

Sensoface	Provides information on the sensor condition
------------------	--

Sensor monitor	Direct display of measured values from sensor for validation (resistance/temperature)
-----------------------	---

Specifications

HOLD input	Galvanically separated (optocoupler)
Function	Switches device to HOLD mode
Switching voltage	0 ... 2 V (AC/DC) HOLD inactive 10 ... 30 V (AC/DC) HOLD active
Output 1	0/4 ... 20 mA, max. 10 V, floating (terminals 8 / 9, galvanically connected to output 2)
Overrange *	22 mA in the case of error messages
Characteristic	Linear, bilinear or logarithmic
Output filter *	PT ₁ filter, time constant 0 ... 120 s
Measurement error ¹⁾	< 0.25% current value + 0.025 mA
Output 2	0/4 ... 20 mA, max. 10 V, floating (terminals 9 / 10, galvanically connected to output 1)
Overrange *	22 mA in the case of error messages
Characteristic	Linear, bilinear or logarithmic
Output filter *	PT ₁ filter, time constant 0 ... 120 s
Measurement error ¹⁾	< 0.25% current value + 0.025 mA

^{*)} user-defined

¹⁾ at normal operating conditions

Relays 1 / 2	Two relay contacts, floating (terminals 14 / 15 / 16)	
Contact ratings	AC < 250 V / < 3 A / < 750 VA DC < 30 V / < 3 A / < 90 W	
Usage	Limit value Alarm Wash	
Limit value	Function	Min or Max
	Setpoint	As desired within range
	Contact response	N/C or N/O
	Hysteresis	User-defined
	Response delay	0000 ... 9999 s
Alarm	Trigger	Failure or Sensoface
	Contact response	N/C or N/O
Wash	Cycle time	0.1 ... 999.9 h
	ON time	0 ... 1999 s
	Contact response	N/C or N/O
Real-time clock	Different time and date formats selectable	
Power reserve	> 5 days	
Display	LC display, 7-segment with icons, colored backlighting	
Primary display	Character height approx. 22 mm, unit symbols approx. 14 mm	
Secondary display	Character height approx. 10 mm	
Text line	14 characters, 14 segments	
Sensoface	3 status indicators (friendly, neutral, sad face)	
Mode indicators	meas, cal, conf, diag Further icons for configuration and messages	
Alarm indication	Display blinks, red backlighting	
Keypad	Keys: meas, info, 4 cursor keys, enter	
Diagnostics		
Calibration data	Calibration date, zero, slope	
Device self-test	Automatic memory test (RAM, FLASH, EEPROM)	
Display test	Display of all segments	
Logbook	100 events with date and time	

Specifications

Service functions

Current source	Current specifiable for output 1 and 2 (00.00 ... 22.00 mA)
Sensor monitor	Display of direct sensor signals (mV/temperature/operating time)
Relay test	Manual control of relay contacts
Device type	Selecting the measuring function

Data retention	Parameters, calibration data, logbook > 10 years (EEPROM)
-----------------------	---

Electrical safety	Protection against electric shock by protective separation of all extra-low-voltage circuits against mains according to EN 61010-1
--------------------------	--

EMC	EN 61326-1
------------	------------

Emitted interference	Class A (industrial applications) ¹⁾
----------------------	---

Immunity to interference	Industrial applications
--------------------------	-------------------------

RoHS conformity	according to EC directive 2011/65/EU
------------------------	--------------------------------------

Power supply	80 V (-15%) ... 230 (+10%) V AC ; approx. 15 VA ; 45 ... 65 Hz 24 V (-15%) ... 60 (+10%) V DC ; 10 W Overvoltage category II, protection class II
---------------------	---

Nominal operating conditions

Climatic class	3K5 according to EN 60721-3-3
----------------	-------------------------------

Location class	C1 according to EN 60654-1
----------------	----------------------------

Ambient temperature	-20 ... 65 °C / -4 ... 149 °F
---------------------	-------------------------------

Relative humidity	10 ... 95 %
-------------------	-------------

Transport and storage

Transport/Storage temperature	-30 ... 70 °C / -22 ... 158 °F
-------------------------------	--------------------------------

Enclosure	Molded enclosure made of PBT/PC, glass fiber reinforced
------------------	---

Mounting	Wall, pipe/post or panel mounting
----------	-----------------------------------

Color	Gray, RAL 7001
-------	----------------

Ingress protection	IP66/IP67/TYPE 4X outdoor (with pressure compensation) when the device is closed
--------------------	--

Flammability	UL 94 V-0 for external parts
--------------	------------------------------

Dimensions	H 148 mm, W 148 mm, D 117 mm
------------	------------------------------

Control panel cutout	138 mm x 138 mm to DIN 43 700
----------------------	-------------------------------

Weight	1.2 kg (1.6 kg incl. accessories and packaging)
--------	---

Cable glands	5 knockouts for M20 x 1.5 cable glands 2 of 5 knockouts for NPT ½" or rigid metallic conduit
--------------	---

Terminals

Screw terminals	for single or stranded wires 0.2 ... 2.5 mm ²
-----------------	--

Tightening torque	0.5 ... 0.6 Nm
-------------------	----------------

¹⁾ This equipment is not designed for domestic use, and is unable to guarantee adequate protection of the radio reception in such environments.

Potassium Chloride Solutions

(Conductivity in mS/cm)

Temperature	Concentration ¹		
	0.01 mol/l	0.1 mol/l	1 mol/l
[°C]			
0	0.776	7.15	65.41
5	0.896	8.22	74.14
10	1.020	9.33	83.19
15	1.147	10.48	92.52
16	1.173	10.72	94.41
17	1.199	10.95	96.31
18	1.225	11.19	98.22
19	1.251	11.43	100.14
20	1.278	11.67	102.07
21	1.305	11.91	104.00
22	1.332	12.15	105.94
23	1.359	12.39	107.89
24	1.386	12.64	109.84
25	1.413	12.88	111.80
26	1.441	13.13	113.77
27	1.468	13.37	115.74
28	1.496	13.62	
29	1.524	13.87	
30	1.552	14.12	
31	1.581	14.37	
32	1.609	14.62	
33	1.638	14.88	
34	1.667	15.13	
35	1.696	15.39	
36		15.64	

1 Data source: K. H. Hellwege (Editor), H. Landolt, R. Börnstein: Zahlenwerte und Funktionen ..., volume 2, part. volume 6

Calibration Solutions

Sodium Chloride Solutions

(Conductivity in mS/cm)

Temperature [°C]	Concentration		
	0.01 mol/l ¹⁾	0.1 mol/l ¹⁾	Saturated ²⁾
0	0.631	5.786	134.5
1	0.651	5.965	138.6
2	0.671	6.145	142.7
3	0.692	6.327	146.9
4	0.712	6.510	151.2
5	0.733	6.695	155.5
6	0.754	6.881	159.9
7	0.775	7.068	164.3
8	0.796	7.257	168.8
9	0.818	7.447	173.4
10	0.839	7.638	177.9
11	0.861	7.831	182.6
12	0.883	8.025	187.2
13	0.905	8.221	191.9
14	0.927	8.418	196.7
15	0.950	8.617	201.5
16	0.972	8.816	206.3
17	0.995	9.018	211.2
18	1.018	9.221	216.1
19	1.041	9.425	221.0
20	1.064	9.631	226.0
21	1.087	9.838	231.0
22	1.111	10.047	236.1
23	1.135	10.258	241.1
24	1.159	10.469	246.2
25	1.183	10.683	251.3
26	1.207	10.898	256.5
27	1.232	11.114	261.6
28	1.256	11.332	266.9
29	1.281	11.552	272.1
30	1.306	11.773	277.4
31	1.331	11.995	282.7
32	1.357	12.220	288.0
33	1.382	12.445	293.3
34	1.408	12.673	298.7
35	1.434	12.902	304.1
36	1.460	13.132	309.5

1 Data source: Test solutions calculated according to DIN IEC 746-3

2 Data source: K. H. Hellwege (Editor), H. Landolt, R. Börnstein: Zahlenwerte und Funktionen ..., volume 2, part. volume 6

Concentration Measurement

Measuring Ranges

Substance	Concentration ranges		
NaCl	0-26 wt% (0 °C / 32 °F) 0-26 wt% (100 °C / 212 °F)		
Configuration	-01-		
HCl	0-18 wt% (-20 °C / -4 °F) 0-18 wt% (50 °C / 122 °F)	22-39 wt% (-20 °C / -4 °F) 22-39 wt% (50 °C / 122 °F)	
Configuration	-02-	-07-	
NaOH	0-13 wt% (0 °C / 32 °F) 0-24 wt% (100 °C / 212 °F)	15-50 wt% (0 °C / 32 °F) 35-50 wt% (100 °C / 212 °F)	
Configuration	-03-	-10-	
H ₂ SO ₄	0-26 wt% (-17 °C/-1.4 °F) 0-37 wt% (110 °C/230 °F)	28-77 wt% (-17 °C/-1.4 °F) 39-88 wt% (115 °C/239 °F)	94-99 wt% (-17 °C/-1.4 °F) 89-99 wt% (115 °C/239 °F)
Configuration	-04-	-09-	-06-
HNO ₃	0-30 wt% (-20 °C / -4 °F) 0-30 wt% (50 °C / 122 °F)	35-96 wt% (-20 °C / -4 °F) 35-96 wt% (50 °C / 122 °F)	
Configuration	-05-	-08-	
H ₂ SO ₄ -SO ₃ (Oleum)	13-45 wt% (0 °C / 32 °F) 13-45 wt% (120 °C / 248 °F)		
Configuration	-11-		

For the solutions listed above, the device can determine the substance concentration from the measured conductivity and temperature values in % by wt. The measurement error is made up of the sum of measurements errors during conductivity and temperature measurement and the accuracy of the concentration curves stored in the device. We recommend to calibrate the device together with the sensor, e.g., directly to concentration using the CAL_CELL method. For exact temperature measurement, you should perform a temperature probe adjustment. For measuring processes with rapid temperature changes, use a separate temperature probe with fast response.

For specification of a concentration solution for conductivity measurement, see page 35.

Concentration Curves

-01- Sodium chloride solution NaCl

← -01- →

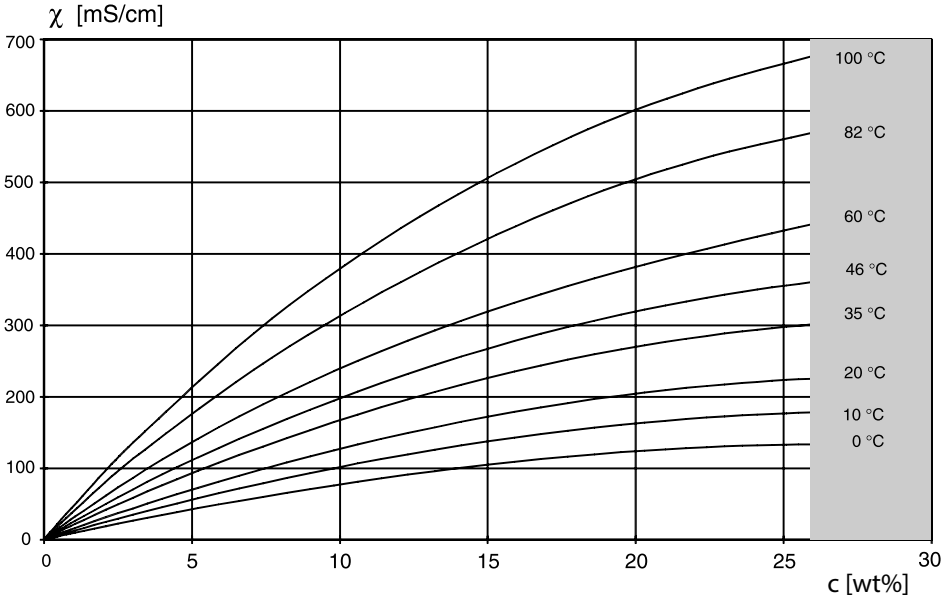

Concentration measurement not possible in this range.

Conductivity versus substance concentration and process temperature for sodium chloride solution (NaCl)

-02- Hydrochloric acid HCl

-07-

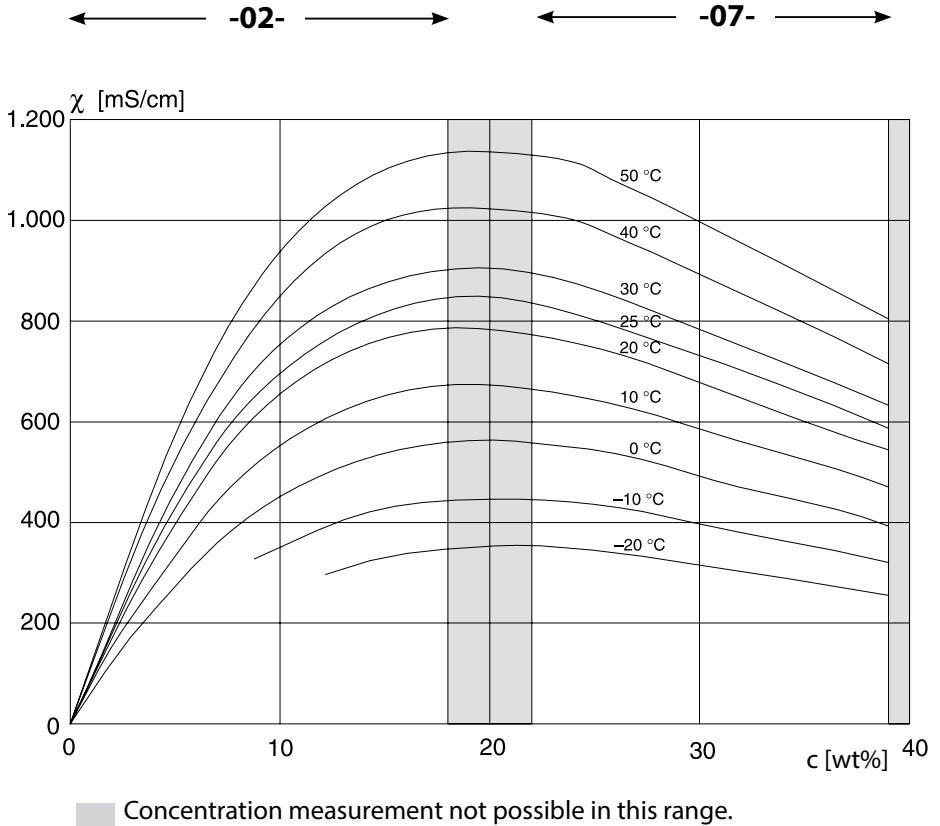

Conductivity versus substance concentration and process temperature for hydrochloric acid (HCl)

Source: Haase/Sauermann/Dücker; Z. phys. Chem. New Edition, Vol. 47 (1965)

-04- Sulfuric acid H_2SO_4

-06-

-09-

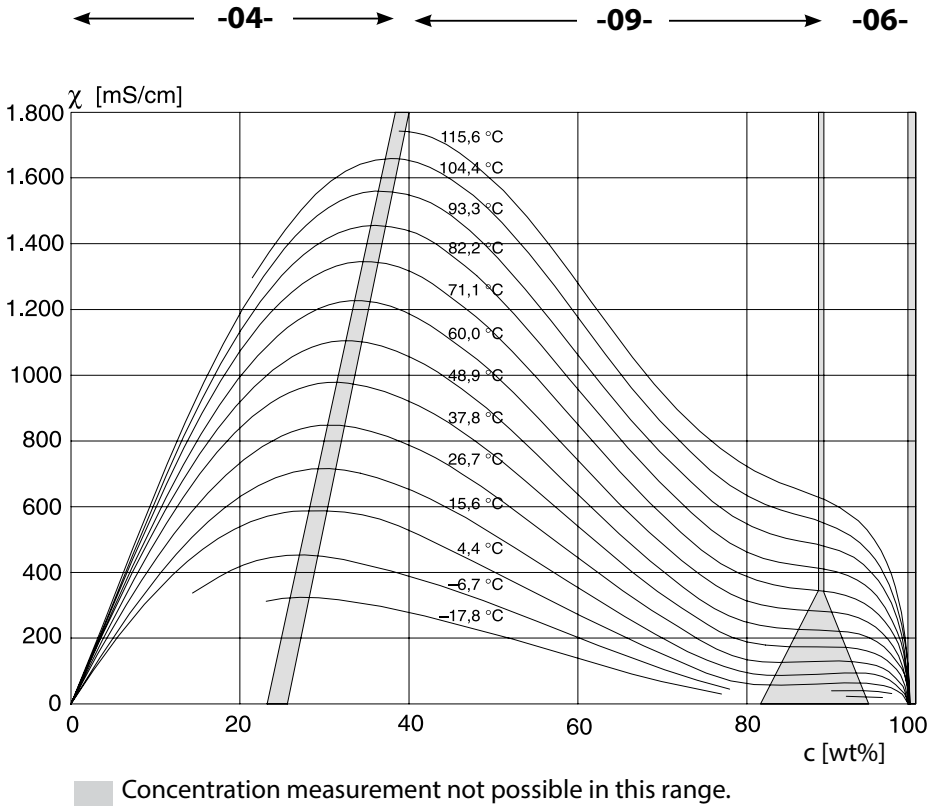

Conductivity versus substance concentration and process temperature for sulfuric acid (H_2SO_4)

Source: Darling; Journal of Chemical and Engineering Data; Vol.9 No.3, July 1964

Concentration Curves

-05- Nitric acid HNO_3
-08-

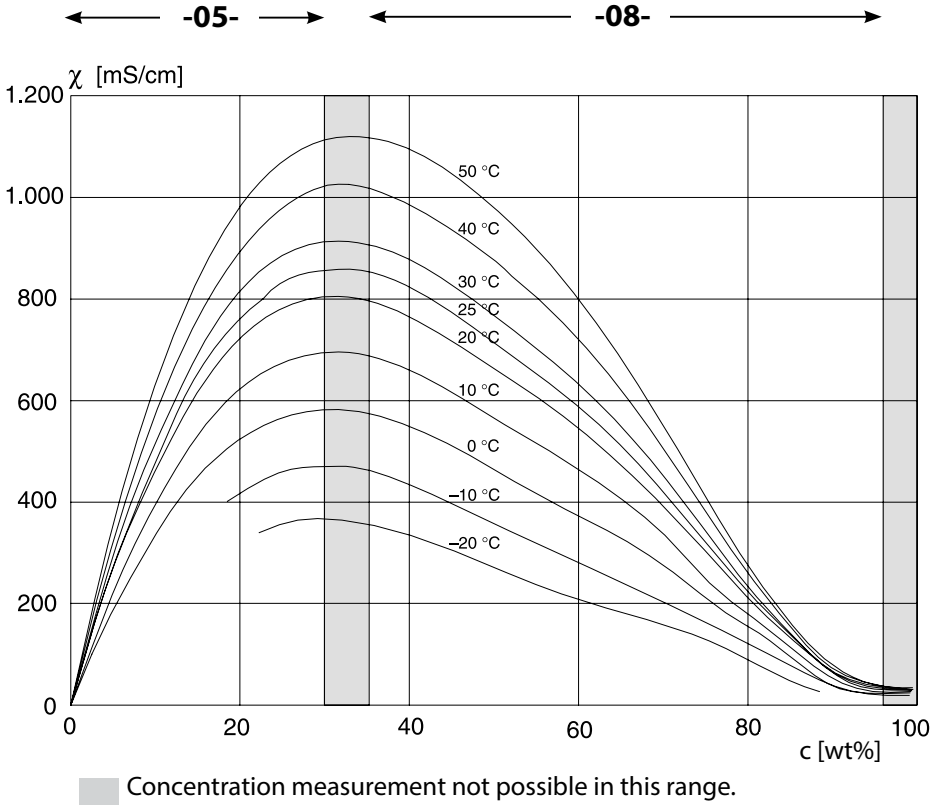

Conductivity versus substance concentration and process temperature for nitric acid (HNO_3)

Source: Haase/Sauermann/Dücker; Z. phys. Chem. New Edition, Vol. 47 (1965)

-11- Oleum $\text{H}_2\text{SO}_4 \cdot \text{SO}_3$

Conductivity
[mS/cm]

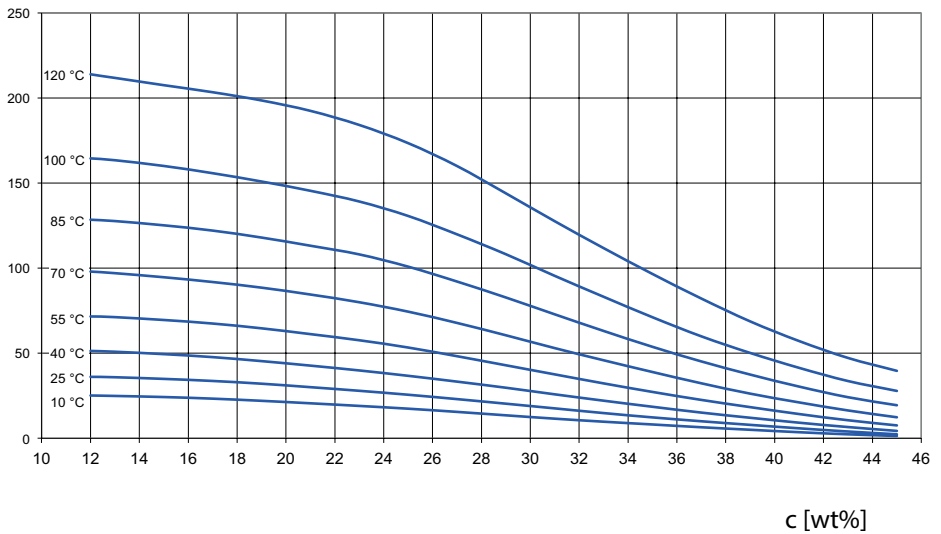

Index

A

- Accessories 91
- AIR-SET calibration 74
- Alarm delay 48
- Alarm, relay contacts 56
- Ambulance TAN 83
- Assembly 9
- Assigning measured values, current start/end 39
- Autorange 39

B

- Backlighting 19
- Bilinear curve 41
- Buttons and functions 18

C

- Cable glands 8
- CALDATA 77
- Calibration 65
- Calibration by input of cell constant 68
- Calibration by input of cell factor 68
- Calibration data, display 77
- Calibration mode 65
- Calibration, product calibration 70
- Calibration solutions 97
- Calibration with calibration solution 66
- Calibration with installation factor 69
- Calibration, zero point (toroidal sensors) 74
- Capacitive loads, protective wiring of relay contacts 60
- Characteristic of output current 40
- Commissioning 6
- Concentration curves, H₂SO₄ 103
- Concentration curves, HCl 101
- Concentration curves, HNO₃ 104
- Concentration curves, NaCl 100
- Concentration curves, NaOH 102
- Concentration curves, oleum 105
- Concentration measurement, custom concentration solution 35
- Concentration ranges 99
- Concentration solution, selection 34
- Cond, calibration 66
- CondI, calibration 73
- Cond range selection 32

- Conductivity configuration 32
- Configuration, alarm delay 48
- Configuration, concentration solution 35
- Configuration, current output 38
- Configuration, measuring point (TAG/GROUP) 62
- Configuration, menu structure 25
- Configuration, output current 38
- Configuration, overview 29
- Configuration, relay contacts 52
- Configuration, Sensocheck 48
- Configuration, sensor 32
- Configuration, Tempcheck 48
- Configuration, temperature compensation 50
- Configuration, time and date 62
- Configuration, time averaging filter 44
- Connecting a Memosens sensor, menu 26
- Connecting a Memosens sensor, terminal assignments 14
- Controlling a rinsing probe via relay contacts 58
- Current calibration data, display 77
- Currently measured values (sensor monitor) 80
- Currently measured values (sensor monitor), display with HOLD activated 82
- Current output, configuration 38
- Current source 82
- Current start/end, assigning measured values 39

D

- Date and time, usage 63
- Date, display 75
- Date, setting 62
- Decommissioning 89
- Device self-test 78
- Device start blocked 84
- Device type Cond(I), configuration 32
- Device type, display 80
- Diagnostics, calibration data 77
- Diagnostics, device self-test 78
- Diagnostics, logbook 79
- Diagnostics mode 76
- Diagnostics, sensor data 77
- Diagnostics, sensor monitor 80
- Diagnostics, version 80
- Dimensions 10

Index

Disabling Sensocheck 49
Display 19
Display backlighting 19
Display, icons 19
Displaying the time/date 75
Display in measuring mode 20
Display, selecting the main display 20
Display test 78
Disposal 89
Documentation 5

E

EEPROM test 78
Electrical installation 13
Enclosure components 9
Enclosure, mounting possibilities 8
ERR 86
Error and HOLD, output current 46
Error messages 86

F

Factory setting 83
FIRMW UPDATE 84
FLASH test 78

G

GROUP of measuring points 63

H

Hardware version, display 80
HOLD, configure output current 46
HOLD, exit 23
HOLD, external activation 23
HOLD mode 23
HOLD, output signal 23
HOLD, output signal response 23
Hose clamps 11
Hysteresis of relay contacts 54

I

- Icons 19
- Inductive conductivity measurement, calibration 73
- Inductive loads, protective wiring of relay contacts 60
- Info text 86
- Installation, notices 13
- Installation, terminal assignments 14
- Intended use 7
- Introduction 8

K

- Keys and functions 18

L

- Limit values (relay contacts) 52
- Logarithmic curve of output current 42
- Logarithmic curve, start and end values 43
- LOGBOOK 79
- Logbook entries, display 79
- Loss of passcode 83

M

- MAIN DISPLAY 20
- Measured values, display 80
- Measuring function (device type) 81
- Measuring mode 75
- Measuring point (TAG/GROUP) 62
- Measuring ranges, concentration 99
- Memosens sensor (connection, menu) 26
- Memosens sensor (connection, terminal assignments) 14
- Memosens sensor (replacement) 27
- MemoSuite software for calibrating Memosens sensors 15
- Menu structure 24
- Menu structure, configuration 25
- Monitoring the temperature probe 49
- Mounting accessories 10
- Mounting accessories, product range 91
- Mounting plan 10

O

- Operating error FIRMW UPDATE 84
- Operating mode, selection 21
- Operating modes, overview 22
- Operating states 90
- Operation, general 17
- Order codes 91
- Output current, characteristic 40
- Output current during Error and HOLD 46
- Output current, fixed value 82
- Output current, logarithmic curve 42
- Output current, range 39
- Output current, time averaging filter 44
- Output filter, time interval 44
- Output signal during HOLD (configuration) 47
- Output signal during HOLD, overview 23
- Overview of configuration 29

P

- Package contents, complete 9
- Package contents, documentation 5
- Panel mounting 12
- Passcode lost 83
- Passcodes, setting 83
- Post/pipe mounting 11
- Potassium chloride solutions, table 97
- Power supply, connection 14
- Power supply, specifications 96
- Process variable not loaded 84
- Process variable selection 39
- Product calibration 70
- Product line 91
- Protective hood 11
- Protective wiring of relay contacts 60

Q

Quickstart guides 5

R

RAM test 78

Rating plates 13

Relay 52

Relay contact delay 54

Relay contacts, alarm 56

Relay contacts, controlling a rinsing probe 58

Relay contacts, function assignment, limit values 52

Relay contacts, protective wiring 60

Relay test (manual test of contacts) 82

Replacing a Memosens sensor 27

Reset to factory settings 83

Returns 89

Rinsing probes, activating 58

S

Safety 6

Safety guide 5

SE 670/SE 680, wiring 16

Selecting the device type 81

Sensocheck (configuration) 49

Sensocheck, description 88

Sensoface, configure output current 47

Sensoface, description 88

Sensoface messages, overview 87

Sensor connection SE 670 / SE 680 16

Sensor data, display 77

Sensor monitor, diagnostics 80

Sensor monitor, Service 82

Sensor replacement 27

Sensor verification (TAG, GROUP) 36

Serial number, display 80

Series resistors 60

Service life of contacts 60

Service mode 81

Service passcode lost 83

Service, relay test 82

Service, reset to factory settings 83

Service, sensor monitor 82

Index

Service, setting the passcodes 83
Service, specify output current 82
Signal colors 19
Sodium chloride solutions, table 98
Software version, display 80
Specifications 92
Specifying the output current 82
Start and end values for logarithmic curve 43
Start-up 15
Supplemental directives 2
Switching characteristics (function) 52

T

Tag number, display 75
TAG of measuring point 63
Technical data 92
Tempcheck 48
Temperature compensation 50
Temperature probe adjustment 72
Temperature probe, monitoring 49
Temperature unit 34
Terminal assignments 14
Terminals 13
Test report 2.2 5
Time and date, usage 63
Time averaging filter 45
Time, display 75
Time format, setting 62
Time, setting 62
Toroidal sensors, calibration 73

U

Use of relays 52

V

Viewing parameters 75

W

Weather protector 11

Wiring 14

Wrench icon 81

Z

Zero calibration (Condl) 74

ZU 0274 pipe-mount kit 11

ZU 0737 protective hood 11

ZU 0738 panel-mount kit 12



Knick
Elektronische Messgeräte
GmbH & Co. KG

Headquarters

Beuckestraße 22 • 14163 Berlin

Germany

Phone: +49 30 80191-0

Fax: +49 30 80191-200

info@knick.de

www.knick.de

Local Contacts

www.knick-international.com

Translation of the original instructions

Copyright 2022 • Subject to change

Version: 3 • This document was published on May 20, 2022.

The latest documents are available for download on our website under the corresponding product description.



100143

TA-212.100-cd-KNEN03