

---

Subject to change without notice.

### **Return of Products Under Warranty**

Please contact our Service Team before returning a defective device. Ship the cleaned device to the address you have been given. If the device has been in contact with process fluids, it must be decontaminated/disinfected before shipment. In that case, please attach a corresponding certificate, for the health and safety of our service personnel.

### **Disposal**

Please observe the applicable local or national regulations concerning the disposal of "waste electrical and electronic equipment".

## **Knick**

### **Elektronische Messgeräte GmbH & Co. KG**

Beuckestraße 22

14163 Berlin

Germany

Phone: +49 30 80191-0

Fax: +49 30 80191-200

Web: [www.knick.de](http://www.knick.de)

Email: [info@knick.de](mailto:info@knick.de)

# Table of Contents

---

<b>Safety Information</b> .....	<b>5</b>
Intended Use.....	7
Registered Trademarks .....	7
<b>Provided Documentation</b> .....	<b>8</b>
<b>Overview of Stratos Eco 2405 Condl</b> .....	<b>9</b>
<b>Assembly</b> .....	<b>10</b>
Package Contents.....	10
Mounting Plan.....	11
Pipe Mounting, Panel Mounting.....	12
<b>Installation and Connection</b> .....	<b>14</b>
Installation Instructions .....	14
Terminal Assignments .....	14
Preparing the Shield Connection .....	16
The Pre-Assembled Special Cable:.....	16
<b>Wiring Examples</b> .....	<b>17</b>
SE655 / SE656 Sensor.....	17
SE660 Sensor.....	18
Sensors From Other Manufacturers .....	19
Protective Wiring of Relay Outputs .....	20
<b>User Interface and Display</b> .....	<b>22</b>
<b>Operation: Keypad</b> .....	<b>24</b>
<b>Safety Functions</b> .....	<b>25</b>
Sensocheck, Sensoface Sensor Monitoring.....	25
GainCheck Device Self-Test.....	25
Automatic Device Self-Test .....	25
Hold Mode .....	26
<b>Configuration</b> .....	<b>28</b>
Menu Structure of Configuration .....	29
Overview of Configuration Steps .....	30
Output 1 .....	32
Output 2 .....	46

# Table of Contents

---

Temperature Compensation .....	52
Alarm Settings .....	54
Limit Function.....	56
Controlling a Rinsing Probe.....	58
Connecting a Rinsing System .....	59
<b>Parameters.....</b>	<b>60</b>
Factory Settings of Parameters .....	60
Parameters – Individual Settings.....	62
<b>Calibration .....</b>	<b>64</b>
Calibration by Input of Cell Factor .....	66
Calibration with Calibration Solution .....	68
Product Calibration .....	70
Zero Calibration in Air .....	72
Zero Calibration with Calibration Solution .....	74
Temp Probe Adjustment.....	75
<b>Measurement .....</b>	<b>75</b>
<b>Diagnostics Functions .....</b>	<b>76</b>
<b>Error Messages (Error Codes) .....</b>	<b>78</b>
<b>Operating States.....</b>	<b>80</b>
<b>Sensoface .....</b>	<b>81</b>
<b>Appendix.....</b>	<b>83</b>
Product Line and Accessories .....	83
Specifications.....	84
Calibration Solutions.....	90
Concentration Curves .....	92
Safe Operation.....	97
<b>Index .....</b>	<b>99</b>
<b>Passcodes .....</b>	<b>103</b>

## **Safety information –**

### **Be sure to read and observe the following instructions!**

The device has been manufactured using state of the art technology and it complies with applicable safety regulations.

When operating the device, certain conditions may nevertheless lead to danger for the operator or damage to the device.

### **CAUTION!**

Commissioning must be carried out by trained experts.

Whenever it is likely that protection has been impaired, the device shall be made inoperative and secured against unintended operation.

The protection is likely to be impaired if, for example:

- the device shows visible damage
- the device fails to perform the intended measurements
- after prolonged storage at temperatures above 70°C / 158 °F
- after severe transport stresses

Before recommissioning the device, a professional routine test in accordance with EN 61010-1 must be performed. This test should be carried out at the manufacturer's factory.

### **CAUTION!**

Before commissioning, make sure that the transmitter may be connected with the other equipment.

---

---

## Intended Use

The Stratos Eco 2405 Condl is used for measurement of electrical conductivity and temperature in liquids using electrodeless (toroidal) sensors. Fields of application are: biotechnology, chemical industry, environment, food processing, water/waste-water treatment.

The sturdy molded enclosure can be fixed into a control panel or mounted on a wall or at a post. The protective hood provides additional protection against direct weather exposure and mechanical damage.

The device has been designed for application with electrodeless sensors, in particular for sensors of the SE 655/656/660 Series (Knick). It provides two current outputs (for transmission of measured value and temperature, for example), two contacts, and a universal power supply 24 ... 230 V AC/DC, AC: 45 ... 65 Hz.

## Registered Trademarks

The following names are registered trademarks. For practical reasons they are shown without trademark symbol in this manual.

Stratos®

Sensocheck®

Sensoface®

GainCheck®

# Provided Documentation

---

## **Safety Instructions**

In official EU languages and others.

## **Quickstart Guides**

In German, English, French, Russian, Finnish, Swedish, Spanish, Portuguese, and Chinese.

- Installation and Commissioning
- Operation
- Menu structure
- Calibration
- Error messages and recommended actions

## **Test Report 2.2**

according to EN 10204



## Overview of Stratos Eco 2405 Condi

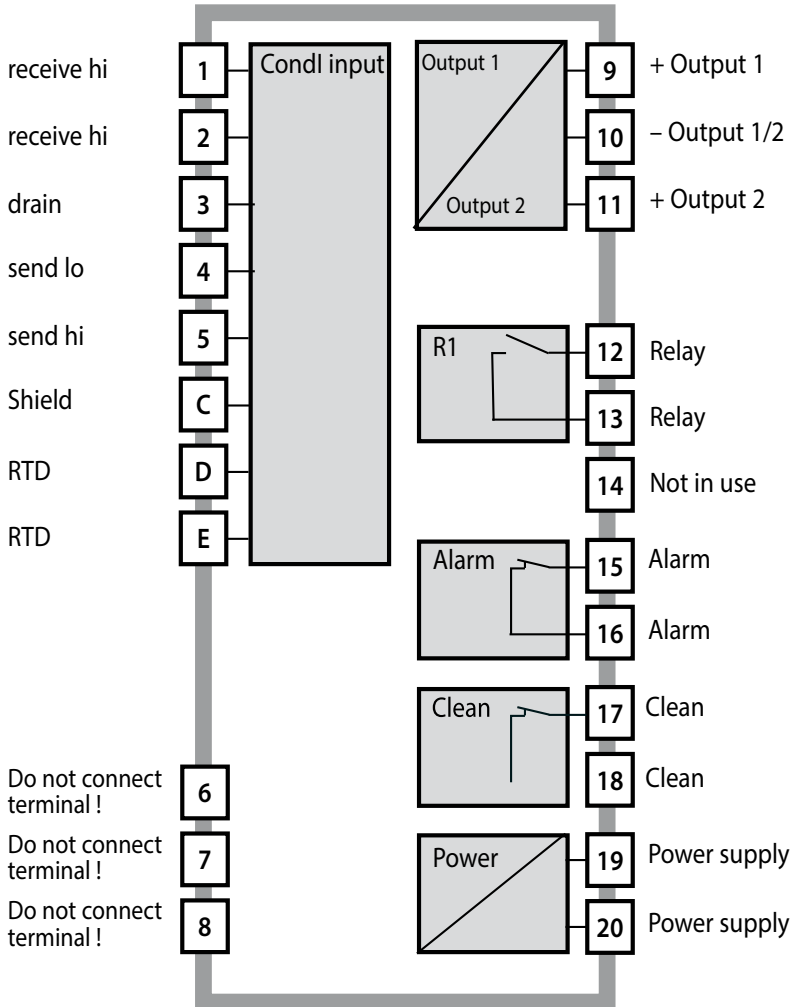

# Assembly

## Package Contents

Check the shipment for transport damage and completeness.  
The package should contain:

- Front unit
- Rear unit
- Bag containing small parts
- Documentation
- Passcode sticker

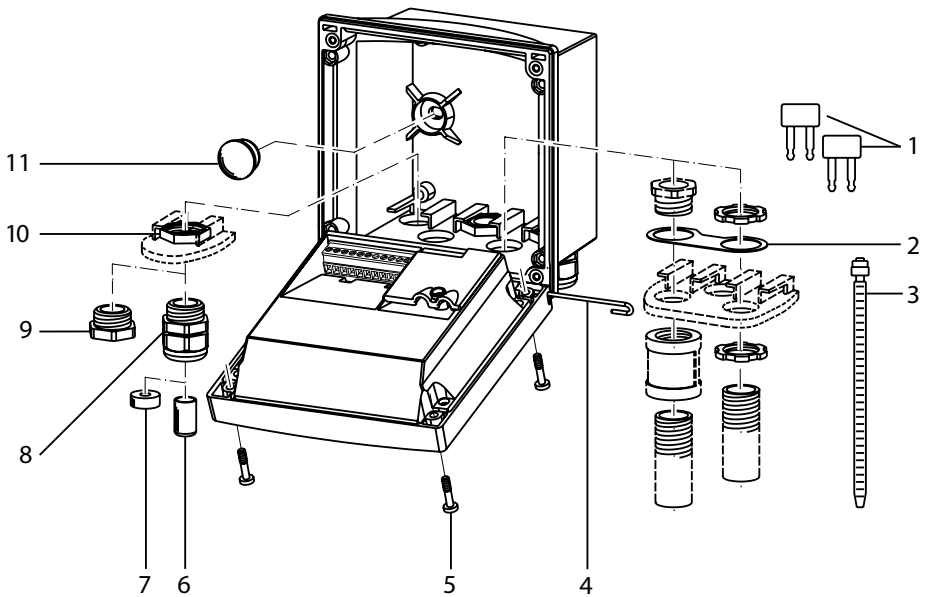

- |  |  |
|--|--|
| 1 Jumper (2 x)   | 6 Sealing insert (1 x)   |
| 2 Washer (1 x), for conduit mounting:<br>Place washer between enclosure and<br>nut | 7 Rubber reducer (1 x)   |
| 3 Cable tie (3 x)  | 8 Cable gland (3 x)  |
| 4 Hinge pin (1 x), insertable from either<br>side                                  | 9 Filler plug (3 x)  |
| 5 Enclosure screw (4 x)  | 10 Hexagon nut (5 x)   |
|  | 11 Sealing plug (2 x), for sealing in case<br>of wall mounting |

Fig.: Assembling the enclosure

## Mounting Plan

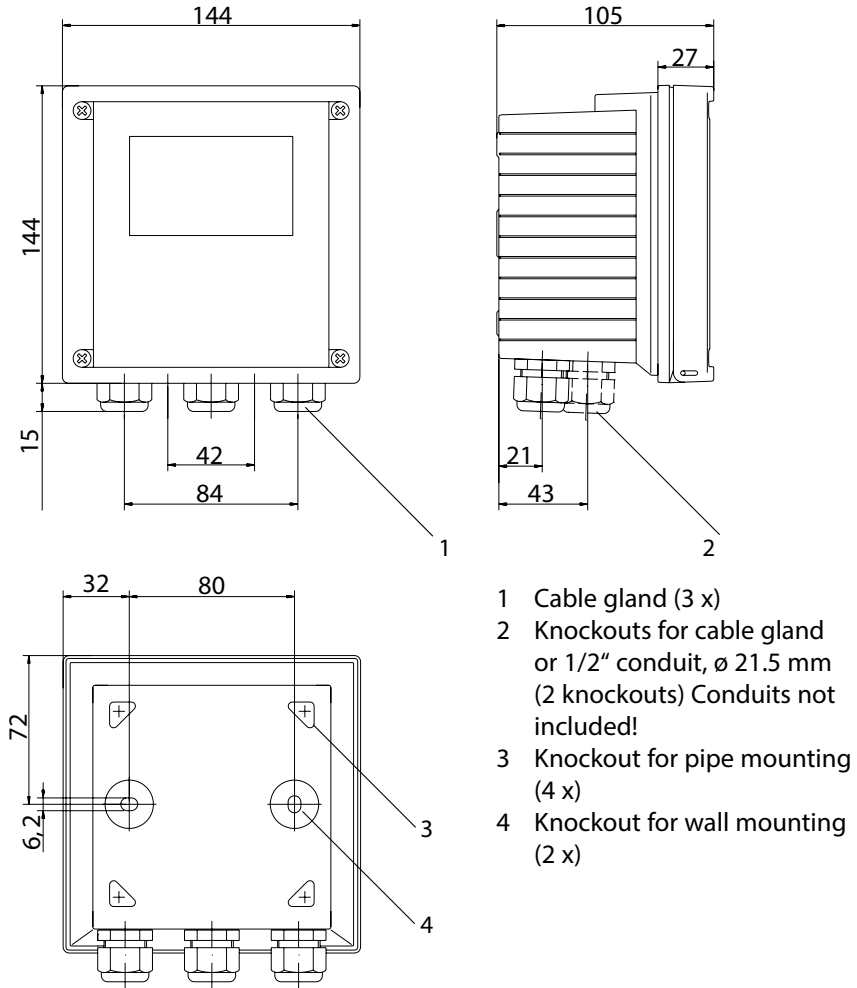
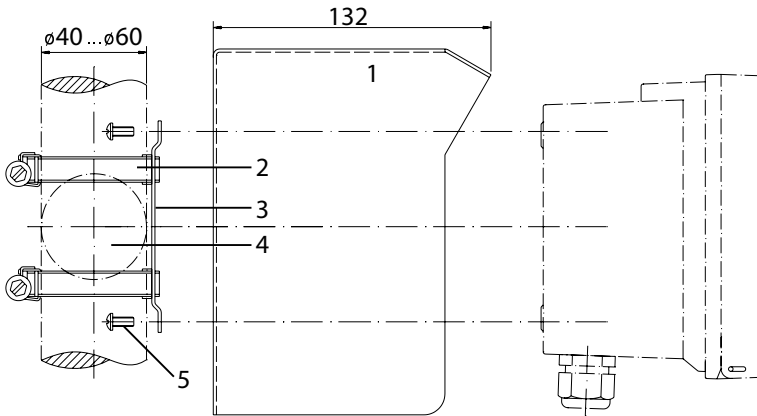

Fig.: Mounting plan (All dimensions in mm!)

## Pipe Mounting, Panel Mounting



- 1 ZU 0276 protective hood (if required)
- 2 Hose clamp with worm gear drive to DIN 3017 (2 x)
- 3 Pipe-mount plate (1 x)
- 4 For vertical or horizontal posts or pipes
- 5 Self-tapping screw (4 x)

Fig.: ZU 0274 pipe-mount kit (All dimensions in mm!)

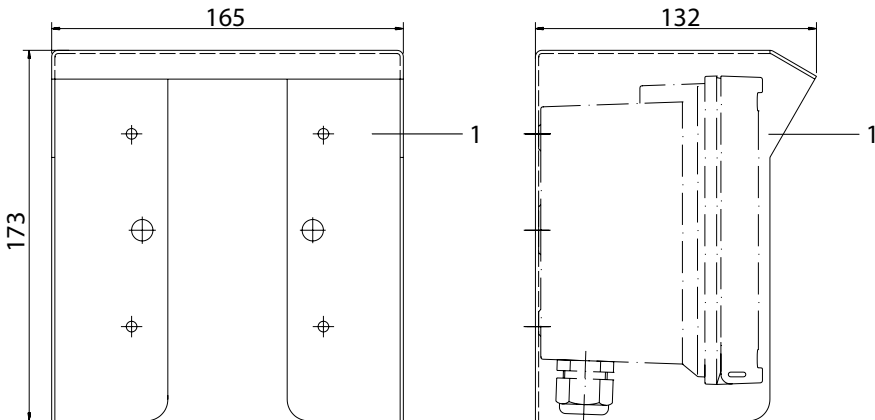
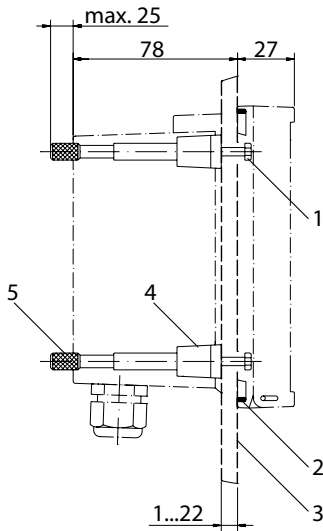

Fig.: ZU 0276 protective hood for wall and pipe mounting  
(All dimensions in mm!)



- 1 Screw (4 x)
- 2 Gasket (1 x)
- 3 Control panel
- 4 Span piece (4 x)
- 5 Threaded sleeve (4 x)

Panel cut-out  
138 x 138 mm (DIN 43700)

Fig.: ZU 0275 panel-mount kit (All dimensions in mm!)

# Installation and Connection

## Installation Instructions

### CAUTION!

- Installation of the Stratos must be carried out by trained experts in accordance with this instruction manual and as per applicable local and national codes.
- Be sure to observe the technical specifications and input ratings during installation.
- Be sure not to notch the conductor when stripping the insulation.
- Before connecting the device to the power supply, make sure that its voltage lies within the range 20.5 ... 253 V AC/DC.
- All parameters must be set by a system administrator prior to commissioning.

The terminals are suitable for single wires and flexible leads up to 2.5 mm<sup>2</sup> (AWG 14).

## Terminal Assignments

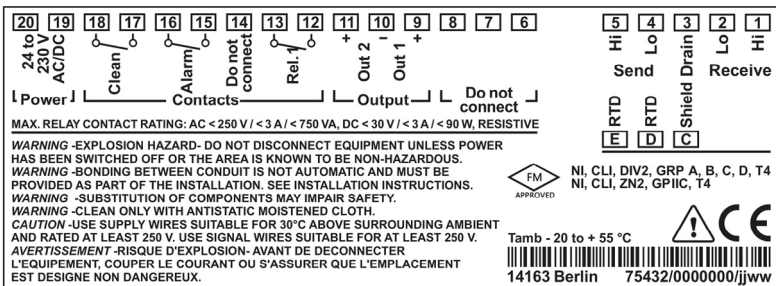
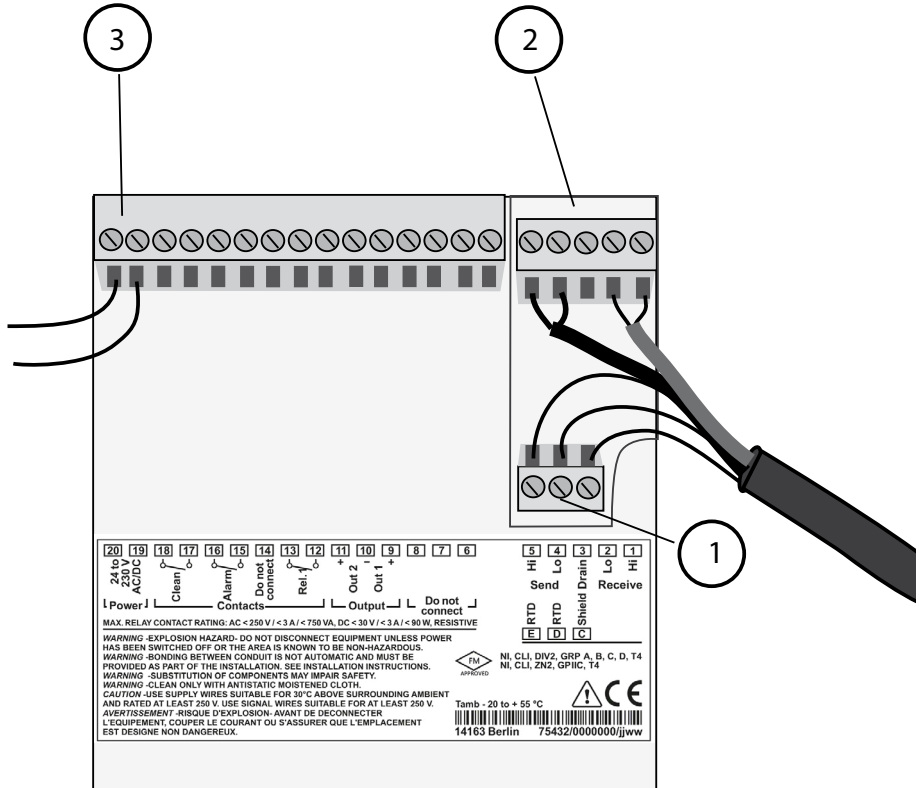

Fig.: Stratos Eco 2405 Condl terminal assignments



- 1 Terminals for temperature probe and outer shield
- 2 Terminals for sensor
- 3 Terminals for power supply

Fig.: Information on installation, rear side of device

## Division 2 Wiring



The connections to the device must be installed in accordance with the National Electric Code (ANSI NFPA 70) Division 2 hazardous (classified) location non-incendive wiring techniques.

# Installation and Connection

## Preparing the Shield Connection

Pre-assembled special cable for SE655 / SE656 sensor

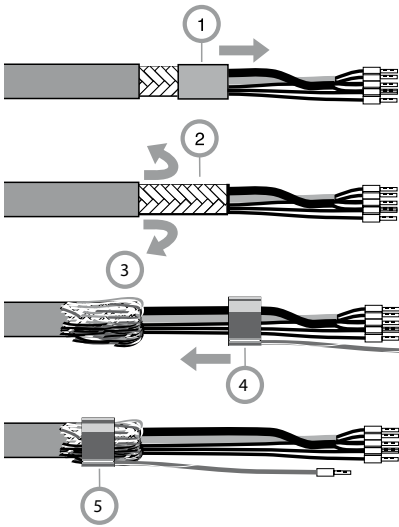

- Insert the special cable through the cable entry into the terminal compartment.
- Remove the already separated part of the cable insulation (1).
- Turn the shielding mesh (2) over the cable insulation (3).
- Then shift the crimp ring (4) over the shielding mesh and tighten it using a pincer (5).

## The Pre-Assembled Special Cable:

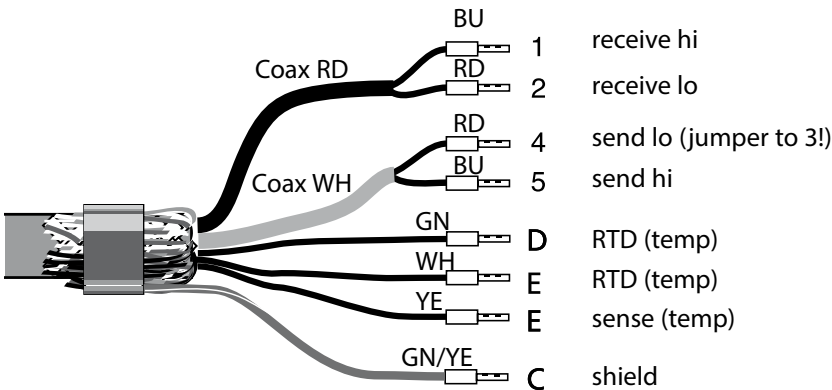



## SE655 / SE656 Sensor

Connecting the pre-assembled cable

Stratos Eco 2405 Condi

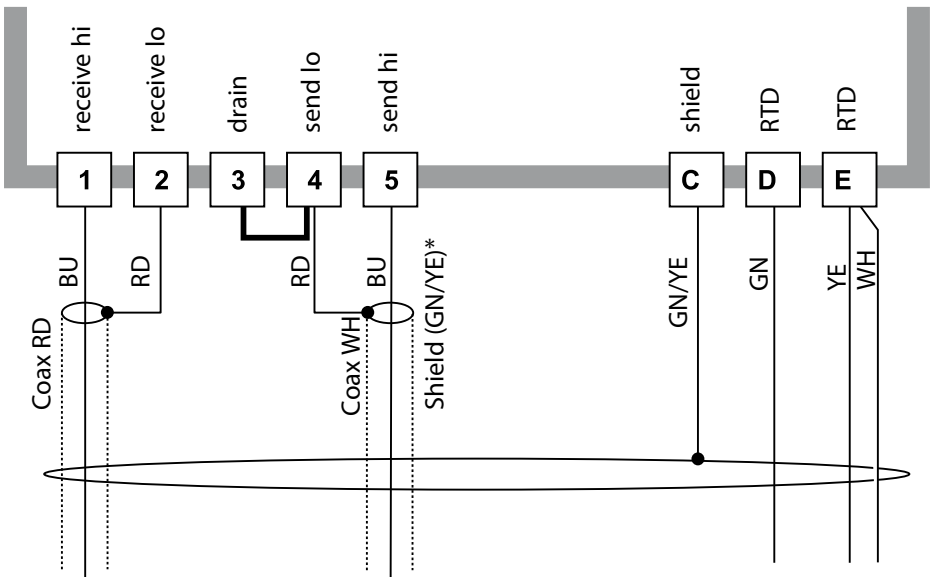

\* Connect the shield wire (green/yellow) to the shielding mesh of the special cable using a crimp ring (see "Preparing the Shield Connection").

# Wiring Examples

## SE660 Sensor

Connecting the pre-assembled cable

Stratos Eco 2405 Condi

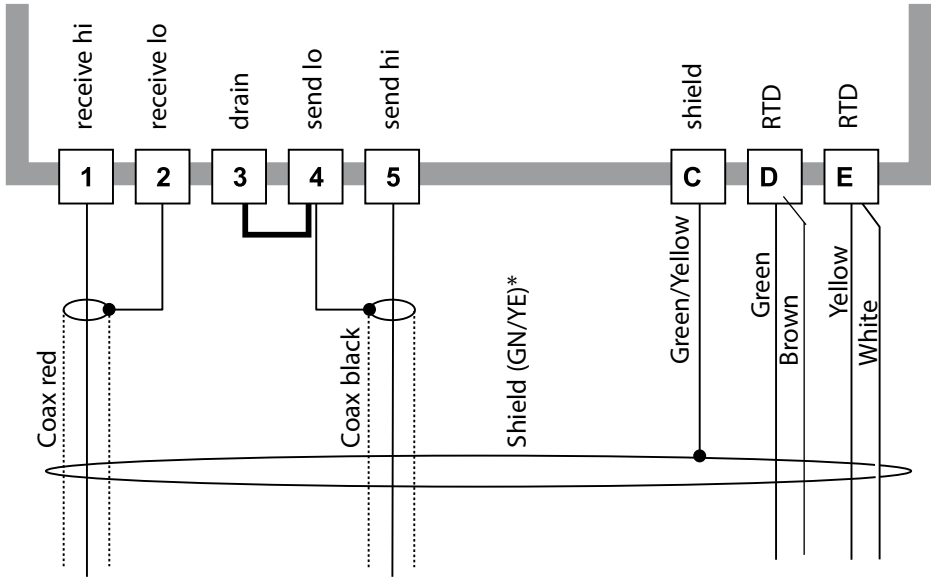

\* Connect the shield wire (green/yellow) to the shielding mesh of the special cable using a crimp ring (see "Preparing the Shield Connection").

## **Sensors From Other Manufacturers**

For special applications (chemical resistance, type of mounting), you can also connect sensors from other manufacturers. Permissible ranges for the Stratos Eco 2405 Condi as well as terminal assignments and factory settings for these sensors are available on request.

# Protective Wiring of Relay Outputs

---

## Protective Wiring of Relay Contacts

Relay contacts are subjected to electrical erosion. Especially with inductive and capacitive loads, the service life of the contacts will be reduced. For suppression of sparks and arcing, components such as RC combinations, nonlinear resistors, series resistors and diodes should be used.

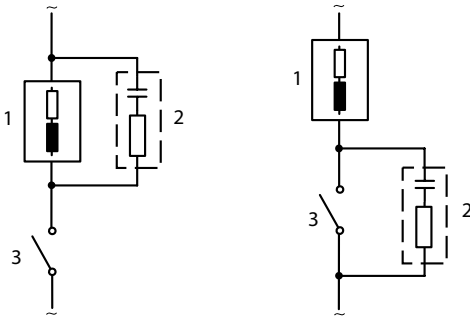

### AC applications with inductive load

- 1 Load
- 2 RC combination, e.g. RIFA PMR 209  
Typical RC combinations for 230 V AC:  
Capacitor 0.1  $\mu\text{F}$  / 630 V Resistor 100 ohms / 1 W
- 3 Contact

## Typical Protective Wiring Measures

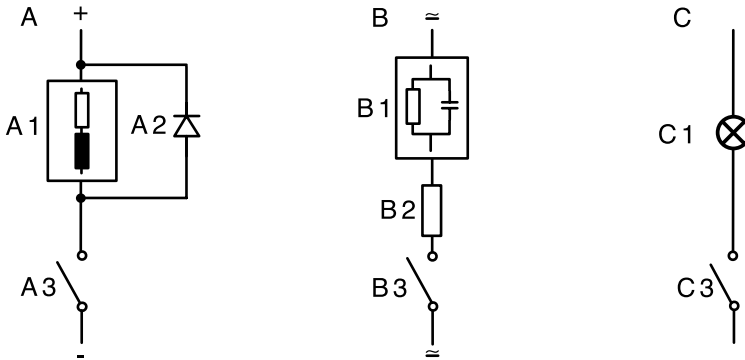

**A: DC application with inductive load**

**B: AC/DC applications with capacitive load**

**C: Connection of incandescent lamps**

A1 Inductive load

A2 Free-wheeling diode, e.g. 1N4007 (Observe polarity)

A3 Contact

B1 Capacitive load

B2 Resistor, e.g.  $8 \Omega$  / 1 W at 24 V / 0.3 A

B3 Contact

C1 Incandescent lamp, max 60 W / 230 V, 30 W / 115 V

C3 Contact

### **WARNING!**

Make sure that the maximum ratings of the relay contacts are not exceeded even during switching!

# User Interface and Display

## User Interface

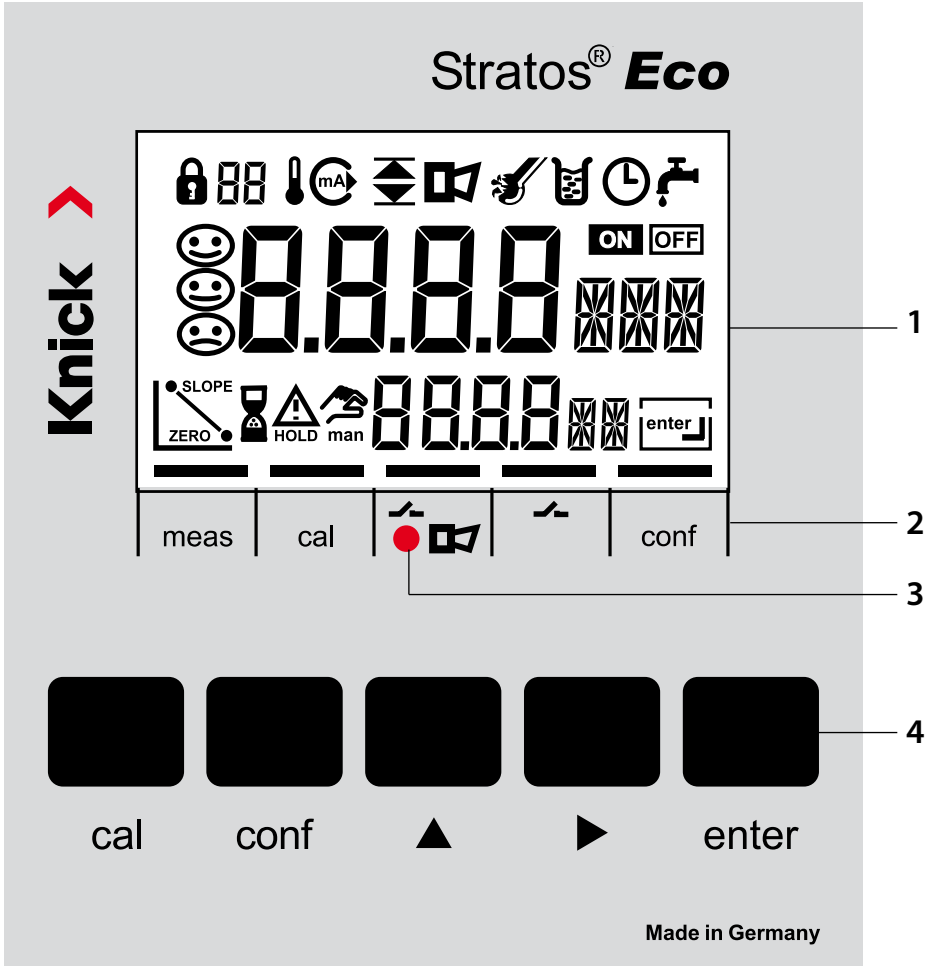

- 1 Display
- 2 Mode indicators (no keys), from left to right:
  - Measuring mode
  - Calibration mode
  - Alarm
  - Wash contact
  - Configuration mode
- 3 Alarm LED
- 4 Keypad

## Display

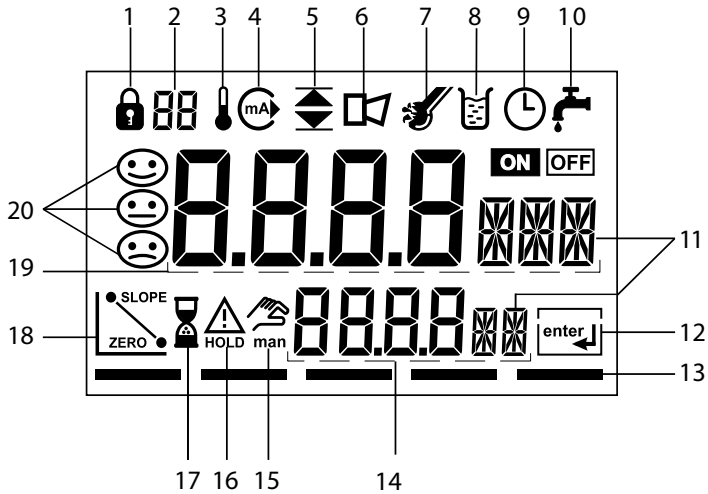

- |    |   |    |                                  |
|----|---|----|----------------------------------|
| 1  | Passcode entry  | 14 | Secondary display                |
| 2  | Not in use  | 15 | Manual temperature specification |
| 3  | Temperature   | 16 | Hold mode active                 |
| 4  | Current output  | 17 | Waiting time running             |
| 5  | Limit values  | 18 | Sensor data                      |
| 6  | Alarm   | 19 | Main display                     |
| 7  | Sensocheck  | 20 | Sensoface                        |
| 8  | Calibration   |    |                                  |
| 9  | Interval/response time  |    |                                  |
| 10 | Wash contact  |    |                                  |
| 11 | Measurement symbol  |    |                                  |
| 12 | Press <b>enter</b> to proceed   |    |                                  |
| 13 | Bar for identifying the device status, above mode indicators, from left to right: |    |                                  |
|    | - Measuring mode  |    |                                  |
|    | - Calibration mode  |    |                                  |
|    | - Alarm   |    |                                  |
|    | - Not in use  |    |                                  |
|    | - Configuration mode  |    |                                  |

# User Interface and Display

---

## Operation: Keypad

<b>cal</b>	Start, end calibration
<b>conf</b>	Start, end configuration
▶	<ul style="list-style-type: none"><li>• Select digit position (selected position blinks)</li><li>• Menu navigation</li></ul>
▲	<ul style="list-style-type: none"><li>• Edit digit</li><li>• Menu navigation</li></ul>
<b>enter</b>	<ul style="list-style-type: none"><li>• Calibration: Continue in program sequence</li><li>• Configuration: Confirm entries, next configuration step</li><li>• Measuring mode: Display output current</li></ul>

<b>cal → enter</b>	Cal Info, display of cell factor
<b>conf → enter</b>	Error Info: Display of last error message
▶ + ▲	Start GainCheck device self-test



## **Sensocheck, Sensoface Sensor Monitoring**

Sensocheck continuously monitors the sensor and its wiring. Sensocheck can be switched off (Configuration, Pg 54).



Sensoface provides information on the conductivity sensor condition. The primary coil and its lines are continuously monitored for short circuits, the secondary coil and its lines are checked for open circuits.

The three Sensoface indicators provide information on the sensor condition.

## **GainCheck Device Self-Test**

A display test is carried out, the software version is displayed, and the memory and measured-value transfer are checked.

Start GainCheck device self-test: ▶ + ▲

## **Automatic Device Self-Test**

The automatic device self-test checks the memory and measured-value transfer. It runs automatically in the background at fixed intervals.

# Safety Functions

---

## Hold Mode

Display: 

The Hold mode is a safety state during configuration and calibration. Output current is frozen (Last) or set to a fixed value (Fix).

Alarm and limit contacts are disabled.

If the calibration or configuration mode is exited, the device remains in the Hold mode for safety reasons. This prevents undesirable reactions of the connected peripherals due to incorrect configuration or calibration. The measured value and "HOLD" are displayed alternately.

The device only returns to measuring mode after **enter** is pressed and 20 seconds have passed.

Configuration mode is also exited automatically 20 minutes (timeout) after the last keystroke. The device returns to measuring mode.

Timeout is not active during calibration.

Behavior of output signal:

**Last:** The output current is frozen at its last value.  
Recommended for short configuration procedures.  
The process should not change decisively during configuration.  
Changes are not noticed with this setting!

**Fix:** The output current is set to a value that is noticeably different from the process value in order to signal the control system that the device is being worked at.

See Configuration Pg 44.

## **Alarm**

Alarm delay is 10 seconds.



During an error message the alarm LED blinks.

Error messages can also be signaled by a 22 mA output current.

The alarm contact is activated by alarm or power failure, see also Pg 55.

# Configuration

In the Configuration mode you set the device parameters.

<p>Activation</p>	<p><b>conf</b></p> 	<p>Activate by pressing <b>conf</b></p> <p>Enter passcode "1200"          Edit parameter using <b>▶</b> and <b>▲</b>,          confirm/proceed using <b>enter</b>.          (End by pressing <b>conf</b>, then <b>enter</b>.)</p>
<p><b>HOLD</b></p> <p>During configuration the device remains in the Hold mode.</p>	 <p>↑          HOLD icon</p>	<p>The output current is frozen (at its last value or at a preset fixed value, depending on the configuration), limit and alarm contacts are inactive. Sensoface is off, "Configuration" mode indicator is on.</p>
<p>Input errors</p>		<p>The configuration parameters are checked during the input. In the case of an incorrect input "Err" is displayed for approx. 2 sec. The incorrect parameters cannot be stored. Input must be repeated.</p>
<p>End</p>	<p><b>conf</b></p> <p><b>enter</b></p>	<p>End by pressing <b>conf</b>. The measured value and Hold are displayed alternately, "enter" blinks.</p> <p>Press <b>enter</b> key to end the Hold mode. The measured value is displayed. The output current remains frozen for another 20 sec (HOLD icon on, "hourglass" blinks).</p>

## Menu Structure of Configuration

The configuration steps are assigned to different menu groups. Using the arrow keys, you can jump between the individual menu groups.

Each menu group contains menu items for setting the parameters. Pressing **enter** opens a menu item.

The values are edited using the arrow keys. Pressing **enter** confirms/saves the settings.

Return to measurement: Press **conf**.

Select menu group	Menu group	Code	Display	Select menu item
	Output 1	o1.		<b>enter</b>
		Menu item 1		<b>enter</b>
		Menu item 2		<b>enter</b>
		:		<b>enter</b>
	Menu item ...			<b>enter</b>
	Output 2	o2.		
	Temperature compensation	tc.		
	Alarm settings	AL.		
	Relay	rL.		
	Rinsing probes	Cn.		 Previous menu group:

# Configuration

## Overview of Configuration Steps

Code	Menu	Selection / Default
<b>out1</b>	<b>Output 1</b>	
<b>o1.SnSR</b>	Sensor selection * * other Enter cell factor Enter transfer ratio Select measuring frequency Select temperature probe	SE655/SE656/SE660/other xx.xxx c xxx.xx 8 kHz / 12 kHz Pt100/Pt1000/NTC100
<b>o1.UnIT</b>	Select process variable	mS/cm, S/m, Conc, SAL
<b>o1.CoNC</b>	Select solution (Conc), see Pg 39 Codes:	NaCl   HCl   NaOH   H <sub>2</sub> SO <sub>4</sub>   HNO <sub>3</sub> -1-   -2-   -3-   -4-   -5-
<b>o1.rNG</b>	Select current range	0-20 mA / 4-20 mA
<b>o1.4mA</b>	Enter current start	xxxx mS
<b>o1.20mA</b>	Enter current end	xxxx mS
<b>o1.FtME</b>	Time constant of output filter	xxxx SEC
<b>o1.FAIL</b>	22 mA signal in the case of error	ON / OFF
<b>o1.HoLD</b>	Signal behavior during HOLD	Last / Fix
<b>o1.FIX</b>	Enter fixed value	xxx.x mA
<b>out2</b>	<b>Output 2</b>	
<b>o2.UnIT</b>	Select temperature unit	°C / °F
<b>o2.rNG</b>	Select current range	0-20 mA / 4-20 mA
<b>o2.4mA</b>	Enter current start	xxx.x
<b>o2.20mA</b>	Enter current end	xxx.x
<b>o2.FtME</b>	Time constant of output filter	xxxx SEC
<b>o2.FAIL</b>	22 mA signal for temperature error	ON / OFF
<b>o2.HoLD</b>	Signal behavior during HOLD	Last / Fix
<b>o2.FIX</b>	Enter fixed value	xxx.x mA
<b>tc.</b>	<b>Temperature compensation</b>	
<b>tc.</b>	Select temp compensation	OFF / Lin / nLF
<b>tc. LIN</b>	Lin: Enter temperature coefficient	xx.xx %/K

<b>Code</b>	<b>Menu</b>	<b>Selection / Default</b>
<b>ALrt</b>	<b>Alarm settings</b>	
<b>AL.SnSO</b>	Select Sensocheck	ON / OFF
<b>rLAY</b>	<b>Relay 1: Limit</b>	
<b>L1.FCT</b>	Select contact function	Lo / Hi
<b>L1.tYP</b>	Select contact response	N/O / N/C
<b>L1.LEVL</b>	Enter setpoint	xxxx
<b>L1.HYS</b>	Enter hysteresis	xxxx
<b>L1.dLY</b>	Enter delay	xxxx SEC
<b>Cn</b>	<b>Cleaning probes</b>	
<b>Cn.InTV</b>	Rinse interval	000.0 h
<b>Cn.rins</b>	Rinse duration	xxxx SEC
<b>Cn.typ</b>	Contact response	N/C / N/O

# Configuration

## Output 1 Selecting the sensor

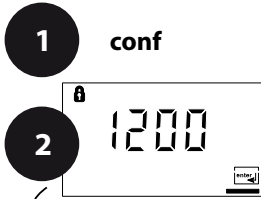

Output 1:

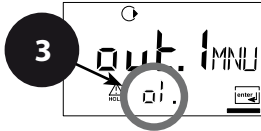

enter →

- 1 Press **conf** key.
- 2 Enter passcode **1200**.
- 3 **Output 1** menu group is displayed. All items of this menu group are indicated by the "o1." code.
- 4 Press **enter** to select menu, edit using arrow keys (see Pg 33). Confirm (and proceed) using **enter**.
- 5 End: Press **conf**, then **enter**.

4

<b>o1.SnSR</b>	Select sensor
<b>o1.UnIT</b>	Select process variable
<b>o1.CoNC</b>	Select solution (Conc)
<b>o1.rNG</b>	Select 0-20 / 4-20 mA
<b>o1.4mA</b>	Enter current start
<b>o1.20mA</b>	Enter current end
<b>o1.FtME</b>	Set output filter
<b>o1.FAIL</b>	22 mA for error
<b>o1.HoLD</b>	HOLD mode

5

**conf enter**

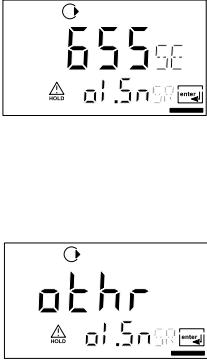

Code	Display	Action	Choices
01.		<p>Select sensor:            Select using ▶ key.            Press <b>enter</b> to proceed.</p> <p><b>Please note:</b> After each sensor selection the nominal cell factor of the sensor is saved. To adjust the cell factor to the device, calibrate the sensor afterwards!</p>	<p><b>SE660</b>            (SE655/            SE656/            SE660/            other see            Pg 35)</p>

**Note:** Characters represented in gray are blinking and can be edited.

# Configuration

## Output 1

### Selecting sensor parameters and temperature probe

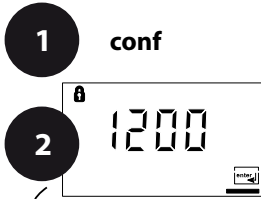

Output 1:

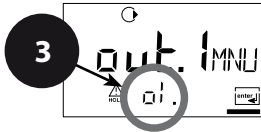

enter

- 1 Press **conf** key.
- 2 Enter passcode **1200**.
- 3 **Output 1** menu group is displayed. All items of this menu group are indicated by the "o1." code.
- 4 Press **enter** to select menu, edit using arrow keys (see Pg 35). Confirm (and proceed) using **enter**.
- 5 End: Press **conf**, then **enter**.

4

<b>o1.SnSR</b>	Select sensor
<b>o1.UnIT</b>	Select process variable
<b>o1.CoNC</b>	Select solution (Conc)
<b>o1.rNG</b>	Select 0-20 / 4-20 mA
<b>o1.4mA</b>	Enter current start
<b>o1.20mA</b>	Enter current end
<b>o1.FtME</b>	Set output filter
<b>o1.FAIL</b>	22 mA for error
<b>o1.HoLD</b>	HOLD mode

5

**conf enter**

Code	Display	Action	Selection
01.		When you have selected "other", the sensor parameters are entered separately:	
		Enter cell factor: Select position using ▶ key and edit number using ▲, press <b>enter</b> to confirm.	
		Enter transfer ratio: Press <b>enter</b> to proceed	
		Select meas. frequency: Select using ▶ key. Press <b>enter</b> to proceed	<b>8 kHz</b> (8 kHz/12 kHz)
		Select temperature probe: Select using ▶ key. Press <b>enter</b> to proceed  <b>Please note</b> When "other" is selected once more, the last sensor parameters are displayed and can be edited.	<b>100Pt</b> (100Pt 1000Pt 100NTC)

**Note:** Characters represented in gray are blinking and can be edited.

# Configuration

## Output 1

### Select process variable

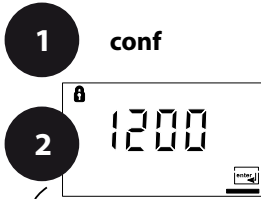

Output 1:

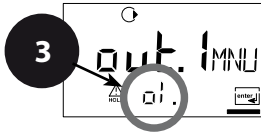

enter

- 1 Press **conf** key.
- 2 Enter passcode **1200**.
- 3 **Output 1** menu group is displayed. All items of this menu group are indicated by the "o1." code.
- 4 Press **enter** to select menu, edit using arrow keys (see Pg 37). Confirm (and proceed) using **enter**.
- 5 End: Press **conf**, then **enter**.

4

<b>o1.SnSR</b>	Select sensor
<b>o1.UnIT</b>	Select process variable
<b>o1.CoNC</b>	Select solution (Conc)
<b>o1.rNG</b>	Select 0-20 / 4-20 mA
<b>o1.4mA</b>	Enter current start
<b>o1.20mA</b>	Enter current end
<b>o1.FtME</b>	Set output filter
<b>o1.FAIL</b>	22 mA for error
<b>o1.HoLD</b>	HOLD mode

enter

5

**conf enter**

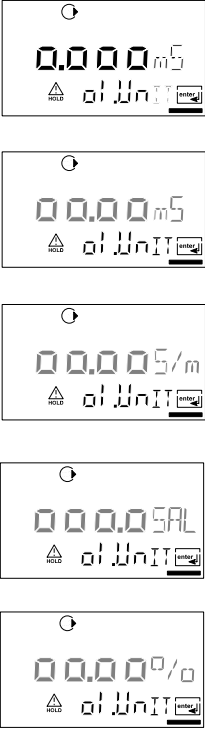
Code	Display	Action	Choices
o1.	 <p>The display shows five sequential screens for unit selection. Each screen has a circular arrow icon at the top, a numerical value in the center, and 'alUnit' with a right arrow at the bottom. The screens show: 0.000 mS, 00.00 mS, 000.0 mS, 0000 mS, 0.000 S/m, 00.00 S/m, 000.0 S/m, 0000 S/m, 0.000 SAL, 00.00 SAL, 000.0 SAL, 0000 SAL, 00.00 %/o, 00.00 %/o, 000.0 %/o, 0000 %/o.</p>	<p><b>Select process variable:</b> Select using ► key, Press <b>enter</b> to proceed.</p> <p><b>Conductivity:</b> 0.000 ... 9.999 mS/cm 00.00 ... 99.99 mS/cm 000.0 ... 999.9 mS/cm 0000 ... 1999 mS/cm 0.000 ... 9.999 S/m 00.00 ... 99.99 S/m</p> <p><b>Salinity (SAL):</b> 0.0 ... 45.0 ‰ (0 ... 35 °C)</p> <p><b>Concentration (Conc):</b> 0.00 ... 9.99% by wt</p>	<p><b>000.0 mS</b> (0.000 mS 00.00 mS 000.0 mS 0000 mS 0.000 S/m 00.00 S/m 000.0 SAL 00.00 % (Conc))</p>

# Configuration

## Output 1

### Concentration measurement: Select process solutions

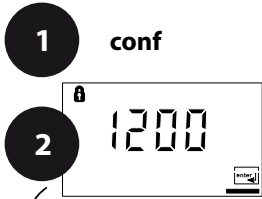

Output 1:

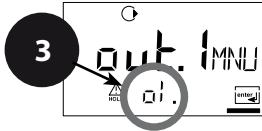

- 1 Press **conf** key.
- 2 Enter passcode **1200**.
- 3 **Output 1** menu group is displayed. All items of this menu group are indicated by the "o1." code.
- 4 Press **enter** to select menu, edit using arrow keys (see Pg 39). Confirm (and proceed) using **enter**.
- 5 End: Press **conf**, then **enter**.

enter

<b>o1.SnSR</b>	Select sensor
<b>o1.UnIT</b>	Select process variable
<b>o1.CoNC</b>	Select solution (Conc)
<b>o1.rNG</b>	Select 0-20 / 4-20 mA
<b>o1.4mA</b>	Enter current start
<b>o1.20mA</b>	Enter current end
<b>o1.FtME</b>	Set output filter
<b>o1.FAIL</b>	22 mA for error
<b>o1.HoLD</b>	HOLD mode

enter

4

5

**conf enter**

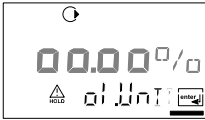
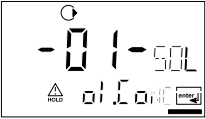
Code	Display	Action	Choices
o1.		Only with 00.00 % Conc can you select the process solution. Select using ► arrow key	<b>-01-SOL</b> (-01-SOL -02-SOL -03-SOL -04-SOL -05-SOL)
		<b>-01-</b> NaCl (0.00 ... 9.99 % by wt) (0 ... 120 °C)	
		<b>-02-</b> HCl (0.00 ... 9.99 % by wt) (-20 ... 50 °C)	
		<b>-03-</b> NaOH (0.00 ... 9.99 % by wt) (0 ... 100 °C)	
		<b>-04-</b> H <sub>2</sub> SO <sub>4</sub> (0.00 ... 9.99 % by wt) (-17 ... 110 °C)	
		<b>-05-</b> HNO <sub>3</sub> (0.00 ... 9.99 % by wt) (-20 ... 50 °C)	
	Press <b>enter</b> to proceed.		

## Concentration Measurement

For the solutions listed above, the device can determine the substance concentration from the measured conductivity and temperature values in % by wt. The measurement error is made up of the sum of measurements errors during conductivity and temperature measurement and the accuracy of the concentration curves stored in the device, see Pg 92.

We recommend to calibrate the device together with the sensor. For exact temperature measurement, you should perform a temperature probe adjustment. For measuring processes with rapid temperature changes, use a separate temperature probe with fast response.

# Configuration

## Output 1

Output current range: **Current start / end**

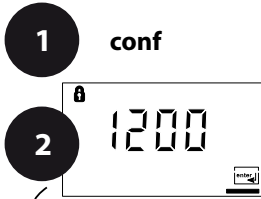

Output 1:

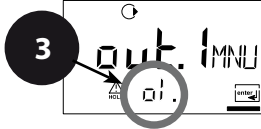

- 1 Press **conf** key.
- 2 Enter passcode **1200**.
- 3 **Output 1** menu group is displayed. All items of this menu group are indicated by the "o1." code.
- 4 Press **enter** to select menu, edit using arrow keys (see Pg 41). Confirm (and proceed) using **enter**.
- 5 End: Press **conf**, then **enter**.

enter →

<b>o1.SnSR</b>	Select sensor
<b>o1.UnIT</b>	Select process variable
<b>o1.CoNC</b>	Select solution (Conc)
<b>o1.rNG</b>	Select 0-20 / 4-20 mA
<b>o1.4mA</b>	Enter current start
<b>o1.20mA</b>	Enter current end
<b>o1.FtME</b>	Set output filter
<b>o1.FAIL</b>	22 mA for error
<b>o1.HoLD</b>	HOLD mode

4



enter



5

**conf enter**

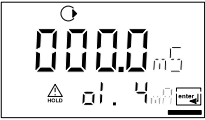

Code	Display	Action	Choices
o1.		Set output current range Select using <b>▶</b> key, press <b>enter</b> to proceed.	<b>4-20 mA</b> (0 - 20 mA/ 4 - 20 mA)
		Current start Enter lower end of scale. Select using <b>▶</b> key, edit number using <b>▲</b> key, press <b>enter</b> to proceed.	<b>000.0 mS</b> (xxx.x mS)
		Current end Enter upper end of scale. Select using <b>▶</b> key, edit number using <b>▲</b> key, press <b>enter</b> to proceed.	<b>100.0 mS</b> (xxx.x mS)

## Assignment of Measured Values: Current Start and Current End

Example 1: Range 0...200 mS/cm

Example 2: Range 100...200 mS/cm  
Advantage: Higher resolution in  
range of interest

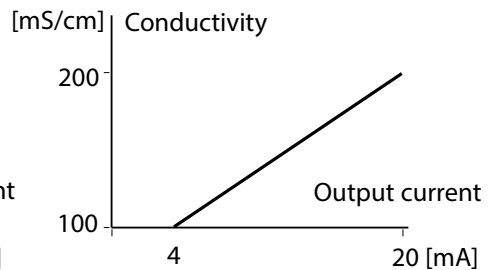
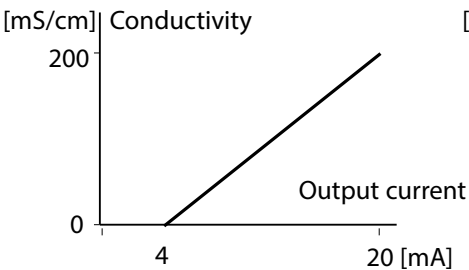

# Configuration

## Output 1

### Time constant of output filter

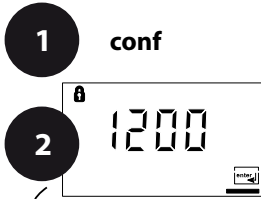

Output 1:

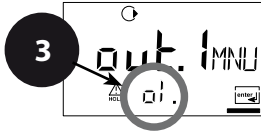

enter

- 1 Press **conf** key.
- 2 Enter passcode **1200**.
- 3 **Output 1** menu group is displayed. All items of this menu group are indicated by the "o1." code.
- 4 Press **enter** to select menu, edit using arrow keys (see Pg 43). Confirm (and proceed) using **enter**.
- 5 End: Press **conf**, then **enter**.



<b>o1.SnSR</b>	Select sensor
<b>o1.UnIT</b>	Select process variable
<b>o1.CoNC</b>	Select solution (Conc)
<b>o1.rNG</b>	Select 0-20 / 4-20 mA
<b>o1.4mA</b>	Enter current start
<b>o1.20mA</b>	Enter current end
<b>o1.FtME</b>	Set output filter
<b>o1.FAIL</b>	22 mA for error
<b>o1.HoLD</b>	HOLD mode

enter



**conf enter**

Code	Display	Action	Choices
o1.		Time constant of output filter Default setting: 0 s (inactive). To specify a time constant: Select using ► key, edit number using ▲ key, press <b>enter</b> to proceed.	<b>0 sec</b> 0 ... 120 sec

## Time Constant of Output Filter (Attenuation)

To smoothen the current output, a low-pass filter with adjustable filter time constant can be switched on. When there is a jump at the input (100 %), the output level is at 63 % after the time constant has been reached.

The time constant can be set from 0 to 120 sec.

If the time constant is set to 0 sec, the current output follows the input.

### Please note:

The filter only acts on the current output, not on the display, the limit values, or the controller!

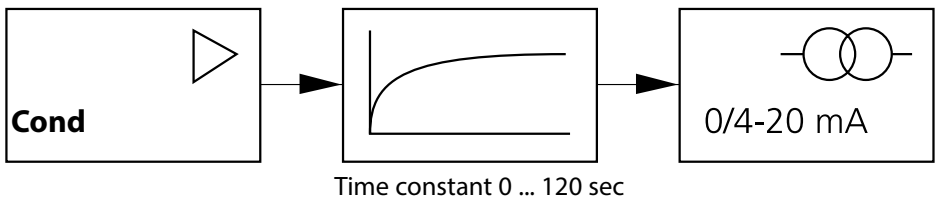

# Configuration

## Output 1

### Output current during Error and HOLD

1 **conf**



2

Output 1:

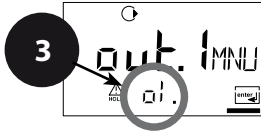

- 1 Press **conf** key.
- 2 Enter passcode **1200**.
- 3 **Output 1** menu group is displayed. All items of this menu group are indicated by the "o1." code.
- 4 Press **enter** to select menu, edit using arrow keys (see Pg 45). Confirm (and proceed) using **enter**.
- 5 End: Press **conf**, then **enter**.

enter →



<b>o1.SnSR</b>	Select sensor
<b>o1.UnIT</b>	Select process variable
<b>o1.CoNC</b>	Select solution (Conc)
<b>o1.rNG</b>	Select 0-20 / 4-20 mA
<b>o1.4mA</b>	Enter current start
<b>o1.20mA</b>	Enter current end
<b>o1.FtME</b>	Set output filter
<b>o1.FAIL</b>	22 mA for error
<b>o1.HoLD</b>	HOLD mode

4

enter

5

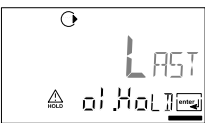
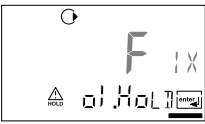
**conf enter**

Code	Display	Action	Choices
o1.		22 mA signal for error message Select using ▶ key, press <b>enter</b> to proceed.	<b>OFF</b> (OFF / ON)
		Output signal during HOLD LAST: During HOLD the last measured value is maintained at the output FIX: During HOLD a value (to be entered) is maintained at the output Select using ▶ key, press <b>enter</b> to proceed.	<b>LAST</b> (LAST / FIX)
	 	Only with FIX selected: Enter current which is to flow at the output during HOLD Select position using ▶ key and edit number using ▲ key. Press <b>enter</b> to proceed.	<b>21.0 mA</b> (00.0 ... 21.0 mA)

## Output Signal During HOLD:

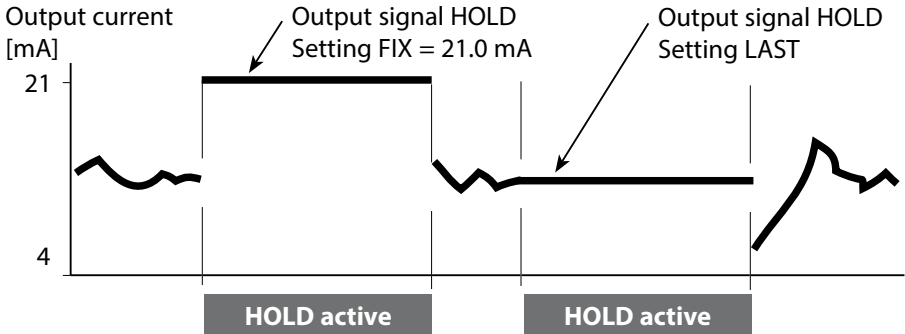

# Configuration

## Output 2

### Temperature unit and probe, output current

1 **conf**

1 Press **conf** key.



2 Enter passcode **1200**.

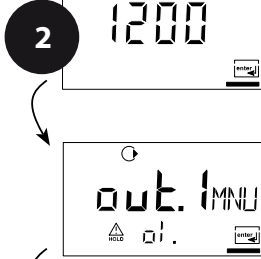

3 Select **Output 2** menu group using arrow keys. All items of this menu group are indicated by the "o2." code.

Output 2:

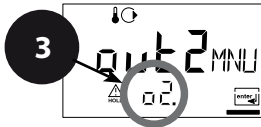

4 Press **enter** to select menu, edit using arrow keys (see Pg 47).

Confirm (and proceed) using **enter**.

5 End: Press **conf**, then **enter**.

enter





<b>o2.UnIT</b>	Select °C/°F
<b>o2.rNG</b>	Select 0-20 / 4-20 mA
<b>o2.4mA</b>	Enter current start
<b>o2.20mA</b>	Enter current end
<b>o2.FtME</b>	Set output filter
<b>o2.FAIL</b>	22 mA for temp error
<b>o2.HoLD</b>	HOLD mode

enter

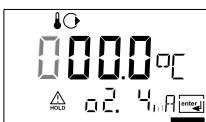

5

**conf enter**

Code	Display	Action	Choices
o2.		Specify temperature unit Select using <b>▶</b> key, press <b>enter</b> to proceed.	<b>°C</b> (°C / °F)
		Select output current range Select using <b>▶</b> key, press <b>enter</b> to proceed.	<b>4 - 20 mA</b> (4 - 20 mA/ 0 - 20 mA)
		Current start: Enter lower end of scale. Select using <b>▶</b> key, edit number using <b>▲</b> key, press <b>enter</b> to proceed.	<b>000.0 °C</b> (xxx.x °C)
		Current start: Enter upper end of scale. Select using <b>▶</b> key, edit number using <b>▲</b> key, press <b>enter</b> to proceed.	<b>100.0 °C</b> (xxx.x °C)

## Process Temperature: Current Start and Current End

Example 1: Range 0 ... 100 °C

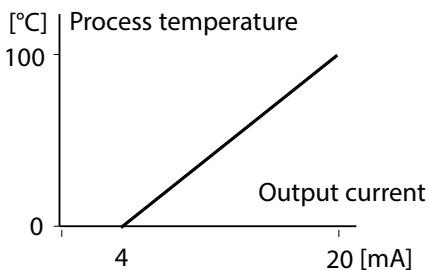

Example 2: Range 50 ... 70 °C

Advantage: Higher resolution in  
range of interest

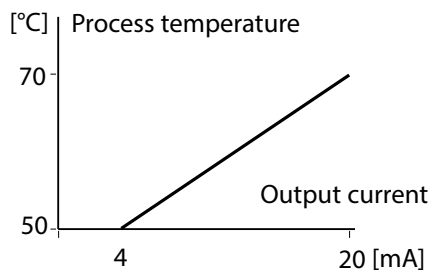

# Configuration

## Output 2

### Time constant of output filter

1 **conf**

- 1 Press **conf** key.
- 2 Enter passcode **1200**.
- 3 Select **Output 2** menu group using arrow keys. All items of this menu group are indicated by the "o2." code.
- 4 Press **enter** to select menu, edit using arrow keys (see Pg 49). Confirm (and proceed) using **enter**.
- 5 End: Press **conf**, then **enter**.

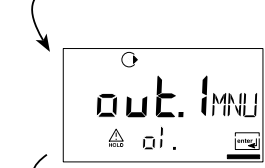

Output 2:



enter

<b>o2.UnIT</b>	Select °C/°F
<b>o2. rTD</b>	Select temp probe
<b>o2.rNG</b>	Select 0-20 / 4-20 mA
<b>o2. 4mA</b>	Enter current start
<b>o2.20mA</b>	Enter current end
<b>o2.FtME</b>	Set output filter
<b>o2.FAIL</b>	22 mA for temp error
<b>o2.HoLD</b>	HOLD mode

4

enter



5

**conf enter**



Code	Display	Action	Choices
o2.		Time constant of output filter Default setting: 0 sec (inactive). To specify a time constant: Select using <b>▶</b> , edit number using <b>▲</b> , press <b>enter</b> to proceed.	<b>0 sec</b> (0 ... 120 sec)

## Time Constant of Output Filter

To smoothen the current output, a low-pass filter with adjustable filter time constant can be switched on. When there is a jump at the input (100 %), the output level is at 63 % after the time constant has been reached.

The time constant can be set from 0 to 120 sec.

If the time constant is set to 0 sec, the current output follows the input.

### Please note:

The filter only acts on the current output, not on the display!

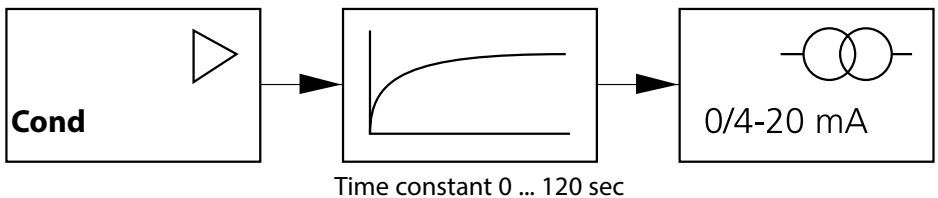

# Configuration

## Output 2

### Temperature error, output current during HOLD

1 **conf**

- 1 Press **conf** key.
- 2 Enter passcode **1200**.
- 3 Select **Output 2** menu group using arrow keys. All items of this menu group are indicated by the "o2." code.
- 4 Press **enter** to select menu, edit using arrow keys (see Pg 51). Confirm (and proceed) using **enter**.
- 5 End: Press **conf**, then **enter**.

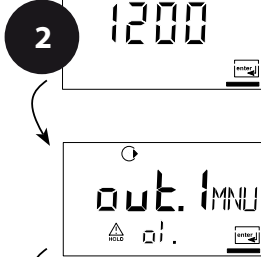

Output 2:

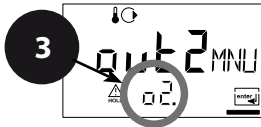

enter

<b>o2.UnIT</b>	Select °C/°F
<b>o2. rTD</b>	Select temp probe
<b>o2.rNG</b>	Select 0-20 / 4-20 mA
<b>o2. 4mA</b>	Enter current start
<b>o2.20mA</b>	Enter current end
<b>o2.FtME</b>	Set output filter
<b>o2.FAIL</b>	22 mA for temp error
<b>o2.HoLD</b>	HOLD mode

4

enter



5

**conf enter**

Code	Display	Action	Choices
o2.		22 mA signal for error message Select using ▶ key, press <b>enter</b> to proceed.	<b>OFF</b> (OFF / ON)
		Output signal during HOLD LAST: During HOLD the last measured value is maintained at the output FIX: During HOLD a value (to be entered) is maintained at the output Select using ▶ key, press <b>enter</b> to proceed.	<b>LAST</b> (LAST / FIX)
	 	Only with FIX selected: Enter current which is to flow at the output during HOLD Select position using ▶ key and edit number using ▲ key. Press <b>enter</b> to proceed.	<b>21.0 mA</b> (00.0 ... 21.0 mA)

## Output Signal During HOLD:

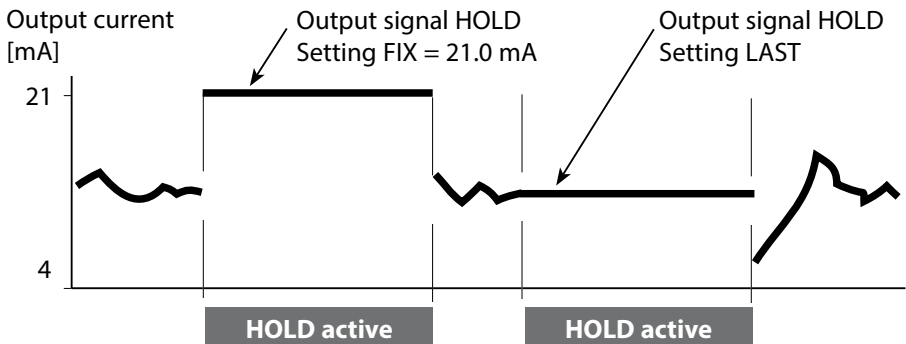

# Configuration

## Temperature Compensation

### Temp compensation selection

- 1 Press **conf** key.
- 2 Enter passcode **1200**.
- 3 Select **Temperature compensation** menu group using arrow keys. All items of this menu group are indicated by the "tc." code.
- 4 Press **enter** to select menu, edit using arrow keys (see Pg 53). Confirm (and proceed) using **enter**.
- 5 End: Press **conf**, then **enter**.

1 **conf**

2



3

Temp compensation:

4

enter **tc.** Select temp compensation

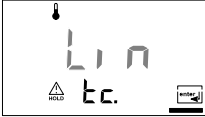
5 **conf enter**

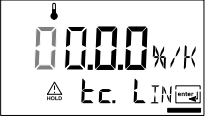
Code	Display	Action	Choices
tc.		Select temp compensation	<b>OFF</b> (OFF LIN nLF)
		<b>OFF:</b> Temperature compensation switched off Select using ► key, press <b>enter</b> to proceed.	
		<b>LIN:</b> Linear temperature compensation with entry of temperature coefficient and reference temperature	
		<b>nLF:</b> Temperature compensation for natural waters to EN 27888	<b>02.00%/K</b> (XX.XX %/K)
		Only with linear temperature compensation ( <b>LIN</b> ) selected: Enter temperature coefficient. Select position using ► key and edit number using ▲ key. Press <b>enter</b> to proceed.	

# Configuration

## Alarm Settings

1 **conf**

2



3

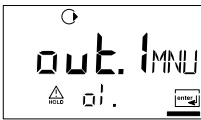

4

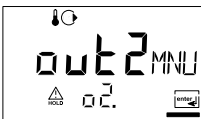

5

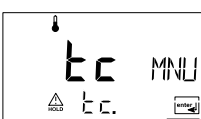

Alarm settings:



enter → **AL.SnSO** Select Sensocheck

4

5 **conf enter**

Code	Display	Action	Choices
AL.		Select Sensocheck (continuous monitoring of sensor) Select using ▶ key, press <b>enter</b> to proceed.	<b>OFF</b> (ON / OFF)

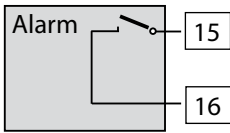

## Alarm Contact

The alarm contact is closed during normal operation (N/C). It opens in the case of alarm or power outage. As a result, a failure message is provided even in the case of line breakage (fail-safe behavior).

For contact ratings, see Specifications.

Error messages can also be signaled by a 22 mA output current (see Pg 44, 50, 78).

The operating behavior of the alarm contact is shown on Pg 80.

The **alarm delay** acts on the LED, the 22 mA signal and the alarm contact.

# Configuration

## Limit Function Relay

1 **conf**

2 

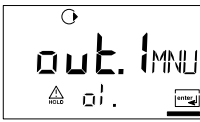

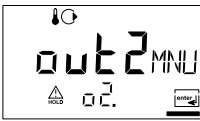

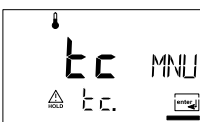

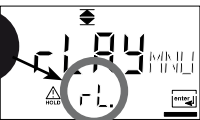

3 **Limit function:**  

enter

- 1 Press **conf** key.
- 2 Enter passcode **1200**.
- 3 Select **Limit function** menu group using arrow keys. All items of this menu group are indicated by the "L1." code.
- 4 Press **enter** to select menu, edit using arrow keys (see Pg 57). Confirm (and proceed) using **enter**.
- 5 End: Press **conf**, then **enter**.

4

L1.FCT	Contact function
L1.tYP	Contact response
L1.LEVL	Enter setpoint
L1.HYS	Enter hysteresis
L1.dLY	Delay

enter  
enter  
enter

5

**conf enter**



Code	Display	Action	Selection
L1.		Contact function (see below for function principle) Select using ▶ key, press <b>enter</b> to proceed.	<b>Lo</b> (Lo/Hi)
		Contact response N/C: normally closed contact N/O: normally open contact Select using ▶ key, press <b>enter</b> to proceed.	<b>N/O</b> (N/O N/C)
		Setpoint Select using ▶ key, edit number using ▲ key, press <b>enter</b> to proceed.	<b>000.0 mS</b> (xxx.x mS)
		Hysteresis Select using ▶ key, edit number using ▲ key, press <b>enter</b> to proceed.	<b>001.0 mS</b> (xxx.x mS)
		Delay The contact is activated with delay (deactivated without delay) Select using ▶ key, edit number using ▲ key, press <b>enter</b> to proceed.	<b>0010 sec</b> (0 ... 9999 sec)

## Limit Lo

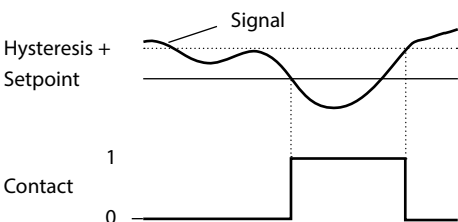

## Limit Hi

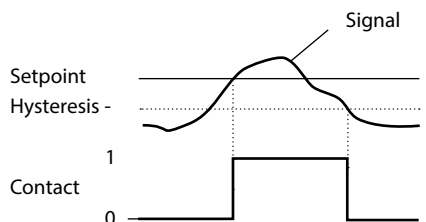

## Controlling a Rinsing Probe “Clean” contact

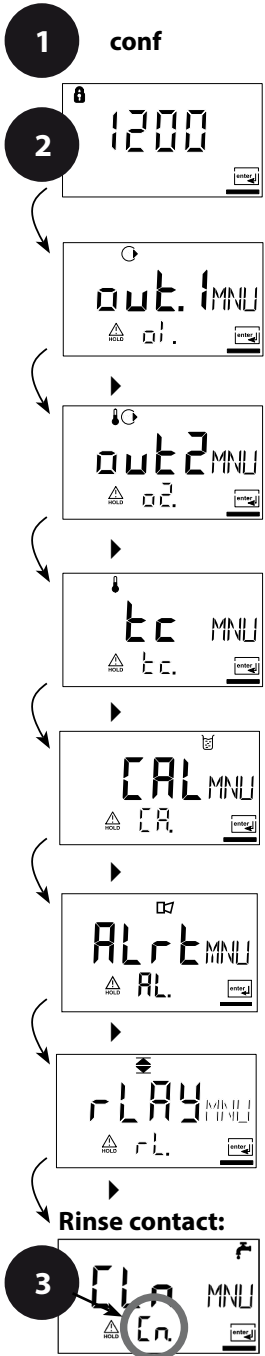



- 1 Press **conf** key.
- 2 Enter passcode **1200**.
- 3 Select **Rinsing probes** menu group using arrow keys. All items of this menu group are indicated by the “Cn.” code.
- 4 Press **enter** to select menu, edit using arrow keys (see next page). Confirm (and proceed) using **enter**.
- 5 End: Press **conf**, then **enter**.

<b>Cn.InTV</b>	Rinsing interval	<div style="text-align: right;"> <span style="font-size: 2em;">4</span>              enter              ↶              ↶              ↶           </div>
<b>Cn.rins</b>	Rinse duration	
<b>Cn.typ</b>	Contact response	

enter

**5** conf enter

Code	Display	Action	Choices
Cn.		Rinsing interval Select using <b>▶</b> key, enter number using <b>▲</b> , press <b>enter</b> to proceed.	<b>0000 h</b> (x.xxx h)
		Rinse duration Select using <b>▶</b> key, enter number using <b>▲</b> , press <b>enter</b> to proceed.	<b>0060 sec</b> (xxxx sec)
		Contact response N/C: normally closed contact N/O: normally open contact Select using <b>▶</b> , press <b>enter</b> to proceed.	<b>N/C</b> (N/O)

## Connecting a Rinsing System

The "Clean" contact can be used to connect a simple spray cleaning system. Rinse duration and rinsing interval are defined during configuration.

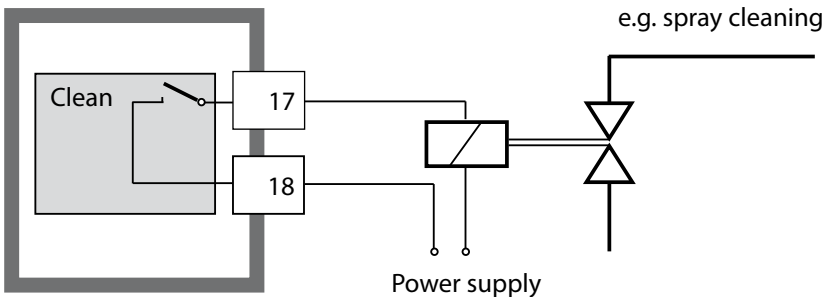

# Parameters

---

## Factory Settings of Parameters

### Activation:

Simultaneously press **conf** + right arrow key and enter passcode "4321".

The lower display line reads "Clear". To prevent accidental resetting, "NO" is set as default (blinking in the main display).

Press one of the arrow keys to select "YES" and confirm by pressing **enter**.

### CAUTION!

Your data (also calibration data) will be overwritten by the factory settings!

Code	Parameter	Factory setting
o1.SnSR	Sensor	SE660
o1.UnIT	Process variable	000.0 mS
o1.CoNC	Conc solution	-01-
o1. rNG	0/4-20 mA	4-20 mA
o1. 4mA	Current start	000.0 mS
o1.20mA	Current end	100.0 mS
o1.FtME	Filter time	0 s
o1.FAIL	22mA signal	OFF
o1.HoLD	HOLD response	Last
o1.FIX	Fix current	021.0 mA
o2.UnIT	Unit °C / °F	°C
o2.rNG	0/4 ...20mA	4-20 mA
o2. 4mA	Current start	000.0 °C
o2.20mA	Current end	100.0 °C
o2.FtME	Filter time	0 s
o2.FAIL	22mA signal	OFF
o2.HoLD	HOLD response	Last
o2.FIX	Fix current	021.0 mA

Code	Parameter	Factory setting
tc.	Temp compensation	OFF
tc. LIN	Temp coefficient	02.00%/K
AL.SnSO	Sensocheck	OFF
L1.FCT	Contact function	Lo
L1.tYP	Contact response	N/O
L1.LEVL	Setpoint	000.0 mS
L1.HYS	Hysteresis	001.0 mS
L1.dLY	Delay	0010 sec
Cn.InTV	Rinsing interval	000.0 h
Cn.rins	Rinse duration	0060 sec
Cn.typ	Contact type	N/C

**Please note:**

Fill in your configuration data on the following pages.

**Please note:**

Factory settings for the calibration data are  $6.4 \text{ cm}^{-1}$  (cell factor) and  $0 \text{ mS/cm}$  (zero point).

# Parameters

---

## Parameters – Individual Settings

Code	Parameters	Setting
o1.SnSR	Sensor	
o1.UnIT	Process variable	
o1.CoNC	Solution (Conc)	
o1. rNG	0/4-20 mA	
o1. 4mA	Current start	
o1.20mA	Current end	
o1.FtME	Filter time	
o1.FAIL	22mA signal	
o1.HoLD	HOLD response	
o1.FIX	Fix current	
o2.UnIT	Unit °C / °F	
o2.rNG	0/4 ...20mA	
o2. 4mA	Current start	
o2.20mA	Current end	

Code	Parameter	Setting
o2.FtME	Filter time	
o2.FAIL	22mA signal	
o2.HoLD	HOLD response	
o2.FIX	Fix current	
tc.	Temp compensation	
tc. LIN	Temp coefficient	
AL.SnSO	Sensocheck	
L1.FCT	Contact function	
L1.tYP	Contact response	
L1.LEVL	Setpoint	
L1.HYS	Hysteresis	
L1.dLY	Delay	
Cn.InTV	Rinsing interval	
Cn.rins	Rinse duration	
Cn.typ	Contact type	





## Information on Calibration

Calibration adapts the device to the conductivity sensor.

Calibration can be performed by:

- Entry of cell factor
- Determining the cell factor with a known calibration solution (calibration standard) taking account of the temperature
- Product calibration
- Zero calibration in air or with calibration solution
- Temperature probe adjustment

### Notice:

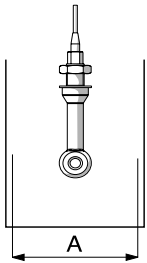





If measurements are performed in fittings with  $A < 110$  mm, be sure to choose a calibration beaker with the same cross-section and of the same material (metal/plastic).

### CAUTION!

- All calibration procedures must be performed by trained personnel. Incorrectly set parameters may go unnoticed, but change the measuring properties.
- When another sensor is used, its sensor data (cell factor, transfer ratio, measuring frequency, temperature probe) must be entered in the configuration menu before calibration.
- Each time a new sensor is connected, the device must be calibrated.

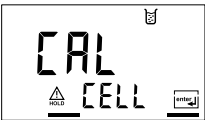
## Calibration by Input of Cell Factor

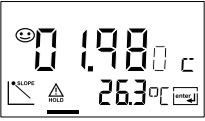

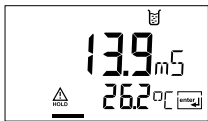

Input of cell factor with simultaneous display of conductivity and temperature (without temperature compensation)



Display	Action	Remark
	Press <b>cal</b> key, enter code 1100. Select using <b>▶</b> key, edit number using <b>▲</b> key, Press <b>enter</b> to proceed.	Device is in the Hold mode. If an invalid code is entered, the device returns to measuring mode.
	Ready for calibration  Remove and clean sensor	Display (2 sec) Device in Hold mode, measured value frozen. Sensoface inactive.
 	Enter cell factor: Select using <b>▶</b> , enter number using <b>▲</b> . Conductivity and temperature are alternately displayed during the input (lower display). Press <b>enter</b> to confirm the entry.	
	The entered cell factor and zero point are displayed. Press <b>enter</b> to confirm.	

Display	Action	Remark
	<p>Conductivity and temperature are displayed.</p>	
	<p>The measured value is shown in the main display alternately with "Hold". "enter" blinks. End calibration by pressing <b>enter</b>.</p>	<p>After end of calibration, the outputs remain in Hold mode for approx. 20 sec.</p>

## Calibration with Calibration Solution

Input of temperature-corrected value of calibration solution (calibration standard) with simultaneous display of cell factor and zero point

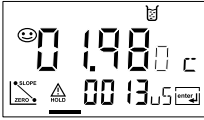
Display	Action	Remark
	Press <b>cal</b> key, enter code 0110. Select using <b>▶</b> key, edit number using <b>▲</b> key. Press <b>enter</b> to proceed.	If an invalid code is entered, the device returns to measuring mode.
	Ready for calibration  Remove and clean sensor	Display (2 sec) Device in Hold mode, measured value frozen. Sensoface inactive.
	Immerse sensor in calibration solution.  Determine the temperature-corrected conductivity value of the calibration solution from the corresponding table (see Pg 69).	When there has not been an entry for 6 sec, the lower display alternately shows the conductivity and temperature value.
	Enter value of calibration solution. Select using <b>▶</b> key, edit number using <b>▲</b> key. Press <b>enter</b> to confirm the calibration.	The measured conductivity and temperature are alternately displayed in the lower display during the input.
		

Display	Action	Remark
	<p>The determined cell factor and zero point are displayed. Press <b>enter</b> to confirm.</p>	
	<p>The device now displays the conductivity and temperature.</p>	
	<p>Clean sensor and re-place it in the process. The measured value is shown in the main display alternately with "Hold". "enter" blinks. End calibration by pressing <b>enter</b>.</p>	<p>After end of calibration, the outputs remain in Hold mode for approx. 20 sec.</p>

**Please note:**

- Be sure to use known calibration solutions with the respective temperature-corrected conductivity values (see "Calibration Solutions" Pg 90).
- During the calibration procedure the temperature must be kept constant.





# Calibration

## Product Calibration

### Calibration by comparison

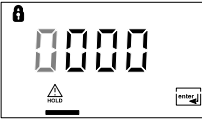



The measurement is only interrupted briefly. During product calibration the sensor remains in the process. Calibration is without TC correction.

**Procedure:** The currently measured value is stored in the device for comparison. A sample is measured using a portable meter. The sample value is then entered in the device. The new cell factor is calculated from these two values.

Display	Action	Remark
	Press <b>cal</b> key, enter code 1105. Press <b>▶</b> key to select position, enter number using <b>▲</b> key, Press <b>enter</b> to confirm.	If an invalid code is entered, the device returns to measuring mode.
		Display (approx. 2 sec)
	Save currently measured value. Press <b>enter</b> to proceed.	Perform reference measurement.
	Enter sample value. The new cell factor is calculated.	

Display	Action	Remark
 <p>The display shows a large '0.198' with a battery icon and a 'C' icon. Below it, there are smaller icons and labels: 'SLOPE', 'ZERO', 'HOLD', and 'ENTER'.</p>	<p>The new cell factor and zero point are displayed. Press <b>enter</b> to confirm.</p>	<p>New calibration: Press <b>cal</b>.</p>
	<p>The new value is shown in the main display alternately with "Hold"; "enter" blinks. End by pressing <b>enter</b>.</p>	<p>After end of calibration, the outputs remain in Hold mode for approx. 20 sec.</p>

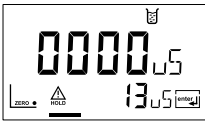
## Zero Calibration in Air



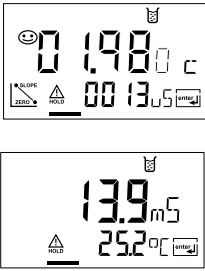

Display	Action	Remark
	<p>Press <b>cal</b> key, enter code 1001.</p> <p>Press <b>▶</b> key to select position, enter number using <b>▲</b> key, Press <b>enter</b> to confirm.</p>	<p>Device is in the Hold mode.</p> <p>If an invalid code is entered, the device returns to measuring mode.</p>
	<p>Ready for calibration</p> <p>Dismount and clean sensor. (Sensor must be dry!)</p>	<p>Display (approx. 2 sec)</p>
	<p>Modify the zero point until zero is displayed as conductivity value in the lower display.</p> <p>Select using <b>▶</b> key, edit number using <b>▲</b> key.</p>	<p>When there has not been an entry for 6 sec, the lower display alternately shows the conductivity and temperature value.</p>
	<p>If required, change the sign of the zero point.</p> <p>Press <b>enter</b> to confirm.</p>	





Display	Action	Remark
	<p>The cell factor and zero point are displayed. Press <b>enter</b> to confirm the calibration data.</p> <p>The device now displays the conductivity and temperature.</p>	
	<p>Place sensor in process. The measured value is shown in the main display alternately with "Hold", "enter" blinks. End calibration by pressing <b>enter</b>.</p>	<p>After end of calibration, the outputs remain in Hold mode for approx. 20 sec.</p>

## Zero Calibration with Calibration Solution

Calibration solution with low conductivity

Display	Action	Remark
	<p>Press <b>cal</b> key, enter code 1001.</p> <p>Press <b>▶</b> key to select position, enter number using <b>▲</b> key.</p> <p>Press <b>enter</b> to confirm.</p>	<p>Device is in the Hold mode.</p> <p>If an invalid code is entered, the device returns to measuring mode.</p>
	<p>Ready for calibration</p> <p>Remove and clean sensor.</p>	<p>Display (approx. 2 sec)</p>
	<p>Immerse sensor in calibration solution.</p> <p>Modify the value until the lower display shows the conductivity value of the calibration solution. Press <b>enter</b> to confirm the calibration.</p>	<p>When there has not been an entry for 6 sec, the lower display alternately shows the conductivity and temperature value.</p>
	<p>The cell factor and zero point are displayed.</p> <p>Press <b>enter</b> to confirm the calibration data.</p>	
	<p>Conductivity and temperature are displayed.</p> <p>Remove the sensor from the calibration solution and clean it. Place sensor in process.</p> <p>The measured value is shown in the main display alternately with "Hold". "enter" blinks.</p> <p>End calibration by pressing <b>enter</b>.</p>	<p>After end of calibration, the outputs remain in Hold mode for approx. 20 sec.</p>

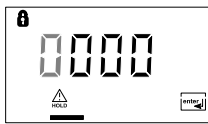



# Temp Probe Adjustment

Display	Action	Remark
	Select calibration Press <b>cal</b> key, enter code 1015. Press <b>▶</b> key to select position, enter number using <b>▲</b> key. Press <b>enter</b> to confirm.	Wrong settings change the measurement properties! If an invalid code is entered, the device returns to measuring mode.
	Ready for calibration Measure the temperature of the process medium using an external thermometer	Device is in Hold mode. Display approx. 2 sec
	Enter measured temperature value. Select using <b>▶</b> key, enter number using <b>▲</b> key. Press <b>enter</b> to proceed. End adjustment by pressing <b>enter</b> . HOLD will be deactivated after 20 sec.	Default: Value of secondary display.



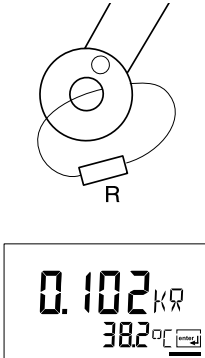

## Measurement

Display	Action
	In the measuring mode the main display shows the configured process variable (conductivity [mS/cm, S/m], concentration [% by wt], or salinity [SAL]) and the lower display shows the temperature. The device is switched to measuring mode by pressing <b>cal</b> during calibration or by pressing <b>conf</b> during configuration (waiting time for signal stabilization approx. 20 sec).

# Diagnostics Functions

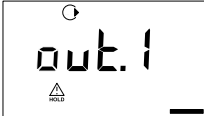
Display	Action
	<b>Display of output currents</b> Press <b>enter</b> while in measuring mode. The current at output 1 is shown in the main display, the current at output 2 in the secondary display. After 5 sec the device returns to measuring mode.
	<b>Display of calibration data (Cal Info)</b> Press <b>cal</b> while in measuring mode and confirm code 0000. The current cell factor is shown in the main display. After 20 sec the device returns to measuring mode (immediate return at pressing <b>enter</b> ).
	<b>Sensor monitor</b> for validation of sensor and complete signal processing. Loop a defined sensing resistor (e.g. $R = 100 \Omega$ ) through the sensor as shown in the figure. Press <b>conf</b> while in measuring mode and enter code 2222. The sensor monitor displays the directly measured resistance and the temperature. If there is a significant difference between resistor value and display, the sensor and its transmission behavior should be checked. Press <b>enter</b> to return to measurement. <b>CAUTION:</b> The device does not automatically go to Hold mode.
	<b>Display of last error message (Error Info)</b> Press <b>conf</b> while in measuring mode and confirm code 0000. The last error message is displayed for approx. 20 sec. After that, the message will be deleted (immediate return to measurement at pressing <b>enter</b> ).















These functions are used for testing the connected peripherals.

Display	Action
	<p><b>Specify current at output 1</b>            Press <b>conf</b> while in measuring mode and enter code 5555.            The current indicated in the main display for output 1 can be edited.</p>
	<p>Select using <b>▶</b> key,            edit number using <b>▲</b> key.            Press <b>enter</b> to confirm entry. The entered value will be shown in the secondary display. The device is in Hold mode. Press <b>conf</b>, then <b>enter</b> to return to measurement (Hold remains active for another 20 sec).</p>
	<p><b>Specify current at output 2</b>            Press <b>conf</b> while in measuring mode and enter code 5556.            The current indicated in the main display for output 2 can be edited.</p>
	<p>Select using <b>▶</b> key,            edit number using <b>▲</b> key.            Press <b>enter</b> to confirm entry. The entered value will be shown in the secondary display. The device is in Hold mode. Press <b>conf</b>, then <b>enter</b> to return to measurement (Hold remains active for another 20 sec).</p>































# Error Messages (Error Codes)

Error	Display	Problem Possible causes	Alarm contact	Red LED	Out 1 (22 mA)	Out 2 (22 mA)
<b>ERR 01</b>	Measured value blinks	<b>Sensor</b> <ul style="list-style-type: none"> <li>• Wrong cell factor</li> <li>• Measuring range exceeded</li> <li>• SAL &gt; 45 ‰</li> <li>• Sensor connection or cable defective</li> </ul>	x	x	x	
<b>ERR 02</b>	Measured value blinks	<b>Unsuitable sensor</b> Conductance range > 3000 mS	x	x	x	
<b>ERR 98</b>	"Conf" blinks	<b>System error</b> Configuration or calibration data defective; completely reconfigure the device using the factory settings. Then calibrate. Memory error in device program	x	x	x	x
<b>ERR 99</b>	"FAIL" blinks	<b>Factory settings</b> EEPROM or RAM defective This error message only occurs in the case of a total defect. The device must be repaired and recalibrated at the factory.	x	x	x	x

# Error Messages (Error Codes)

Error	Icon (blinks)	Problem Possible causes	Alarm contact	Red LED	Out 1 (22 mA)	Out 2 (22 mA)
ERR 03		<b>Temperature probe</b> Open or short circuit Temperature range exceeded	x	x	x	x
ERR 11		<b>Current output 1</b> Current below 0 (3.8) mA	x	x	x	
ERR 12		<b>Current output 1</b> Current above 20.5 mA	x	x	x	
ERR 13		<b>Current output 1</b> Current span too small / too large	x	x	x	
ERR 21	 	<b>Current output 2</b> Current below 0 (3.8) mA	x	x		x
ERR 22	 	<b>Current output 2</b> Current above 20.5 mA	x	x		x
ERR 23	 	<b>Current output 2</b> Current span too small / too large	x	x		x
ERR 33	 	<b>Sensocheck:</b> Primary coil	x	x	x	
ERR 34						
	 	Temperature outside conversion tables (TC, conc, SAL)	Sensoface active, see Pg 82			

# Operating States

Operating status	Out 1	Out 2	Relay 1 limit value	Alarm contact	Cleaning contact	Timeout
Measure						
Cal Info (cal) 0000						20 s
Error Info (conf) 0000						20 s
Calibration (cal) 1100						
Temp adjustment (cal) 1015						
Product calibration (cal) 1105						
Configuration (conf) 1200						20 min
Sensor monitor (conf) 2222						20 min
Current source 1 (conf) 5555						20 min
Current source 2 (conf) 5556						20 min
Rinsing function						

 active

 as configured (Last/Fix or Last/Off)



The smiley in the display (Sensoface) alerts to sensor problems (defective sensor, defective cable). The conditions for a friendly, neutral, or sad Sensoface are summarized in the following chart. Additional icons refer to the error cause.

## Sensocheck

Continuously monitors the primary coil and its lines for short circuits and the secondary coil and its lines for open circuits. Sensocheck can be switched off. Critical values make the Sensoface “sad” and the corresponding icon blinks:



Sensocheck messages are also output as error messages Err 33 or Err 34. The alarm contact is active, the red LED is lit, output current 1 is set to 22 mA (when configured correspondingly). Sensocheck can be switched off during configuration (then Sensoface is also disabled).

### **Exception:**





After a calibration a smiley is always displayed for confirmation.

## **Notice**

The worsening of a Sensoface criterion leads to the devaluation of the Sensoface indicator (Smiley becomes “sad”). An improvement of the Sensoface indicator can only take place after calibration or removal of the sensor defect.

# Sensoface

---

Display	Problem	Status
	Sensor defect	 Short circuit in primary coil Open circuit in secondary coil (see also Error Messages Err 33 and Err 34, Page 79).
 	Temperature error	 Temperature outside range for TC, conc, SAL

## Product Line and Accessories

### Devices

Stratos Eco 2405 Condl

### Order No.

2405 Condl

### Mounting Accessories

Pipe-mount kit

ZU 0274

Panel-mount kit

ZU 0275

Protective hood

ZU 0276

### Please note:

For special applications (chemical resistance, type of mounting), you can also connect sensors from other manufacturers. Permissible ranges for the Stratos Eco 2405 Condl as well as terminal assignments and factory settings for these sensors are available on request.

For more information concerning our sensors and fittings product line, please refer to our website:  
[www.knick.de](http://www.knick.de)

# Specifications

---

<b>Condl input</b>	Input for electrodeless conductivity sensors: SE 655, SE 656, SE660 and others	
Display range	Conductivity	0.000 ... 1999 mS/cm
	Concentration	0.00 ... 9.99% by wt
	Salinity	0.0 ... 45 ‰ (0 ... 35 °C)
Ranges	Conductivity	0.000 ... 9.999 mS/cm
		00.00 ... 99.99 mS/cm
		000.0 ... 999.9 mS/cm
		0000 ... 1999 mS/cm
		0.000 ... 9.999 S/m
		00.00 ... 99.99 S/m
	Concentration	0.00 ... 9.99% by wt
	Salinity	0.0 ... 45 ‰ (0 ... 35 °C)
Response time ( $T_{90}$ )	Approx. 2 s	
Meas. error <sup>1,2,3)</sup>	< 1% meas. val. + 0.005 mS	
<b>Temp compensation *</b> (reference temp 25°C)	(OFF)	Without
	(LIN)	Linear characteristic 00.00 ... 19.99 %/K
	(NLF)	Natural waters to EN 27888 (0 ... 35°C)
<b>Concentration determination</b>		
Operating modes *	-01-	NaCl 0.00...9.99 % by wt (0...60 °C)
	-02-	HCl 0.00...9.99 % by wt (-20...50 °C)
	-03-	NaOH 0.00...9.99 % by wt (0...100 °C)
	-04-	H <sub>2</sub> SO <sub>4</sub> 0.00...9.99 % by wt (-17...110 °C)
	-05-	HNO <sub>3</sub> 0.00...9.99 % by wt (-20...50 °C)
	See graphs in the Appendix Pg 92	

## Sensor standardization

Operating modes	<ul style="list-style-type: none"> <li>• Entry of cell factor with simultaneous display of conductivity and temperature</li> <li>• Entry of conductivity of calibration solution with simultaneous display of cell factor and temperature</li> <li>• Product calibration</li> <li>• Zero adjustment</li> <li>• Temperature probe adjustment</li> </ul>
Permitted cell factor	00.100 ... 19.999
Permitted transfer ratio	01.00 ... 199.99
Permitted zero offset	± 0.5 mS/cm

## Sensor monitoring

### Sensocheck

- Monitoring of primary and lines for short circuit
- Monitoring of secondary and wiring for open circuit

### Sensoface

Provides information on the sensor condition (evaluation of zero point, Sensocheck)

### Sensor monitor

Sensor monitor for validation of sensor and complete signal processing (display: resistance / temperature)

## Temperature input \*

	Pt100/Pt1000/NTC 100 kΩ 2-wire connection, adjustable	
Measuring range	Pt 100/Pt 1000	-20.0 ... +200.0 °C (-4 ... +392 °F)
	NTC 100 kΩ	-20.0 ... +130.0 °C (-4 ... +266 °F)
Resolution	0.1 °C / 0.1 °F	
Meas. error <sup>1,2,3)</sup>	< 0.5 K (< 1K for Pt100; < 1K for NTC > 100 °C)	

# Specifications

---

<b>Output 1</b>	0/4 ... 20 mA, max. 10 V, floating (galvanically connected to output 2)
Process variable*	Conductivity, concentration, or salinity
Overrange*	22 mA in the case of error messages
Output filter*(attenuation)	Low-pass, filter time constant 0 ... 120 s
Measurement error <sup>1)</sup>	< 0.3% current value + 0.05 mA
Start/end of scale	As desired within range
Minimum span	5 % of selected range

<b>Output 2</b>	0/4 ... 20 mA, max. 10 V, floating (galvanically connected to output 1)
Process variable	Temperature
Overrange*	22 mA in case of temp error messages
Output filter*(attenuation)	Low-pass, filter time constant 0 ... 120 s
Measurement error <sup>1)</sup>	< 0.3% current value + 0.05 mA
Start/end of scale*	-20 ... 300 °C / -4 ... 572 °F
Admissible span	20 ... 320 K / 36 ... 576 °F

<b>Alarm contact</b>	Relay contact, floating
Contact ratings	AC < 250 V / < 3 A / < 750 VA DC < 30 V / < 3 A / < 90 W
Contact response	N/C (fail-safe type)
Alarm delay	10 s

<b>Limit values</b>	Output via relay contact
Contact ratings	AC < 250 V / < 3 A / < 750 VA DC < 30 V / < 3 A / < 90 W
Contact response*	N/O or N/C
Delay*	0000 ... 9999 s
Setpoints*	As desired within range
Hysteresis*	0 ... 50 % full scale

<b>Cleaning function</b>	Relay contact, floating, for controlling a simple rinsing system or an automatic cleaning system
Contact ratings	AC < 250 V / < 3 A / < 750 VA DC < 30 V / < 3 A / < 90 W
Contact response	N/C or N/O
Rinse interval	000.0 ... 999.9 h (000.0 h = cleaning function switched off)
Rinse duration	0000 ... 1999 s
<b>Display</b>	LC display, 7-segment with icons
Main display	Character height 17 mm, unit symbols 10 mm
Secondary display	Character height 10 mm, unit symbols 7 mm
Sensoface	3 status indicators (friendly, neutral, sad face)
Mode indication	4 mode indicators "meas", "cal", "alarm", "config" Further icons for configuration and messages
Alarm indication	Red LED in case of alarm
<b>Keypad</b>	5 keys: [cal] [conf] [▶] [▲] [enter]
<b>Service functions</b>	
Current source	Current specifiable for output 1 and 2 (00.00 ... 22.00 mA)
Device self-test	Automatic memory test (RAM, FLASH, EEPROM)
Display test	Display of all segments
Last Error	Display of last error occurred
Sensor monitor	for validation of sensor and complete signal processing (display: resistance / temperature)
<b>Data retention</b>	Parameters and calibration data > 10 years (EEPROM)
<b>Protection against electric shock</b>	Safe electrical isolation of all extra-low-voltage circuits against mains by double insulation to EN 61010-1

# Specifications

---

**Power supply** 24 (-15%)...230 V AC/DC (+10%); appr. 5 VA, 2.5 W  
AC: 45 ... 65 Hz  
Overvoltage category II, protection class II

## **Nominal operating conditions**

Ambient temperature -20 ... +55°C / -4 ... +131 °F  
Transport/Storage temp -20 ... +70 °C / -4 ... +158 °F  
Relative humidity 10...95 % not condensing,  
maximum operating height 2000 m  
Power supply 24 (-15%) ... 230 V AC/DC (+10%)  
Frequency for AC 45 ... 65 Hz

## **EMC**

EN 61326-1, EN 61326-2-3  
Emitted interference Class B (residential area)  
Class A for mains > 60 V DC  
Immunity to interference Industry

## **Explosion protection**

**FM** NI Class I Div 2 Group A, B, C & D, T4 Ta = 55 °C;  
Type 2  
NI Class I Zone 2 Group IIC, T4 Ta = 55°C; Type 2



<b>Enclosure</b>	Molded enclosure made of PBT, glass bead reinforced
Color	Black
Mounting	<ul style="list-style-type: none"><li>• Wall mounting</li><li>• Pipe mounting: Ø 40 ... 60 mm, □ 30 ... 45 mm</li><li>• Panel mounting, cutout to DIN 43 700 Sealed against panel</li></ul>
Dimensions	H 144 mm, W 144 mm, D 105 mm
Ingress protection:	IP 65 / NEMA 4X
Cable glands	3 knockouts for cable glands M20x1.5 2 knockouts for NPT 1/2" or rigid metallic conduit
Weight	Approx.1 kg

\* User-defined

1) To IEC 746 Part 1, at nominal operating conditions

2) ± 1 count

3) Plus sensor error

# Calibration Solutions

---

## Potassium Chloride Solutions (Conductivity in mS/cm)

Temperature	Concentration <sup>1)</sup>		
°C	0.01 mol/l	0.1 mol/l	1 mol/l
0	0.776	7.15	65.41
5	0.896	8.22	74.14
10	1.020	9.33	83.19
15	1.147	10.48	92.52
16	1.173	10.72	94.41
17	1.199	10.95	96.31
18	1.225	11.19	98.22
19	1.251	11.43	100.14
20	1.278	11.67	102.07
21	1.305	11.91	104.00
22	1.332	12.15	105.94
23	1.359	12.39	107.89
24	1.386	12.64	109.84
25	1.413	12.88	111.80
26	1.441	13.13	113.77
27	1.468	13.37	115.74
28	1.496	13.62	
29	1.524	13.87	
30	1.552	14.12	
31	1.581	14.37	
32	1.609	14.62	
33	1.638	14.88	
34	1.667	15.13	
35	1.696	15.39	
36		15.64	

- 1) Data source: K. H. Hellwege (Editor), H. Landolt, R. Börnstein: Zahlenwerte und Funktionen ..., volume 2, part. volume 6  
2) Data source: Test solutions calculated according to DIN IEC 746-3

## Sodium Chloride Solutions (Conductivity in mS/cm)

Temperature	Concentration		
°C	0.01 mol/l <sup>2)</sup>	0.1 mol/l <sup>2)</sup>	Saturated <sup>1)</sup>
0	0.631	5.786	134.5
1	0.651	5.965	138.6
2	0.671	6.145	142.7
3	0.692	6.327	146.9
4	0.712	6.510	151.2
5	0.733	6.695	155.5
6	0.754	6.881	159.9
7	0.775	7.068	164.3
8	0.796	7.257	168.8
9	0.818	7.447	173.4
10	0.839	7.638	177.9
11	0.861	7.831	182.6
12	0.883	8.025	187.2
13	0.905	8.221	191.9
14	0.927	8.418	196.7
15	0.950	8.617	201.5
16	0.972	8.816	206.3
17	0.995	9.018	211.2
18	1.018	9.221	216.1
19	1.041	9.425	221.0
20	1.064	9.631	226.0
21	1.087	9.838	231.0
22	1.111	10.047	236.1
23	1.135	10.258	241.1
24	1.159	10.469	246.2
25	1.183	10.683	251.3
26	1.207	10.898	256.5
27	1.232	11.114	261.6
28	1.256	11.332	266.9
29	1.281	11.552	272.1
30	1.306	11.773	277.4
31	1.331	11.995	282.7
32	1.357	12.220	288.0
33	1.382	12.445	293.3
34	1.408	12.673	298.7
35	1.434	12.902	304.1
36	1.460	13.132	309.5

# Concentration Curves

---

## -01- Sodium chloride solution NaCl

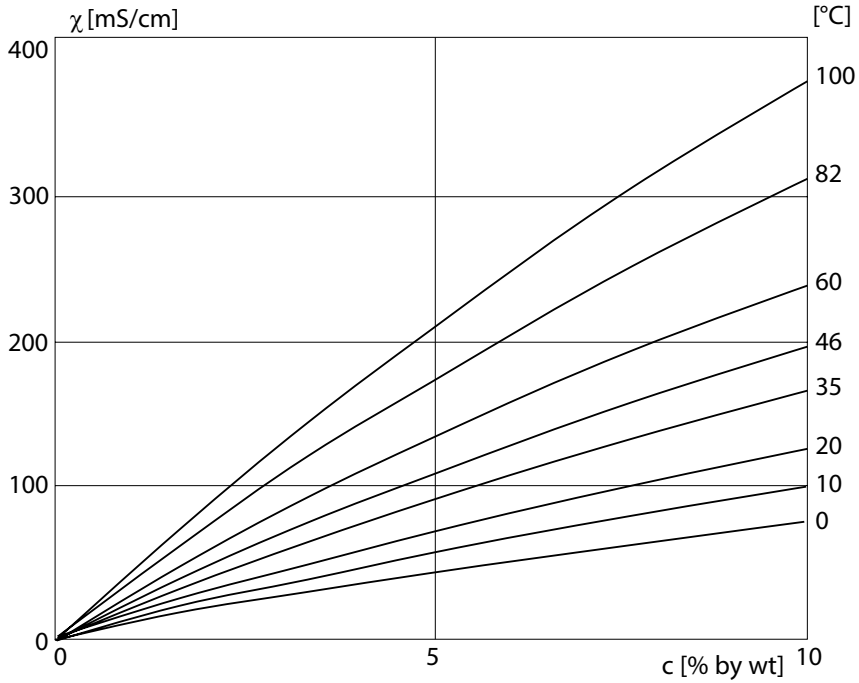

Conductivity versus substance concentration and process temperature for sodium chloride solution (NaCl)

## -02- Hydrochloric acid HCl

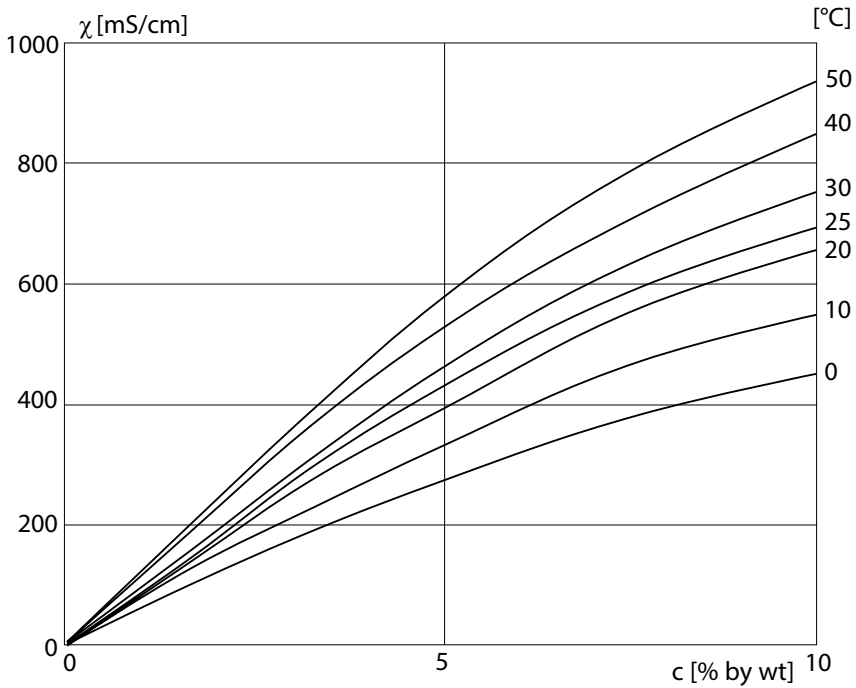

Conductivity versus substance concentration and process temperature for hydrochloric acid (HCl)

Source: Haase/Sauermann/Dücker; Z. phys. Chem. New Edition, Vol. 47 (1965)

## -03- Sodium hydroxide solution NaOH

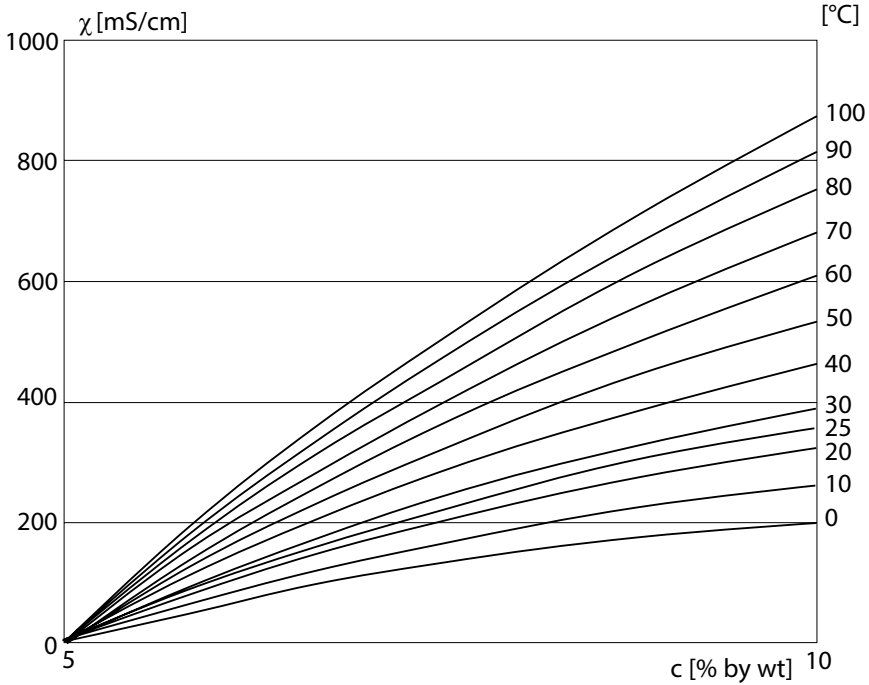

Conductivity versus substance concentration and process temperature for sodium hydroxide solution (NaOH)

## -04- Sulfuric acid $H_2SO_4$

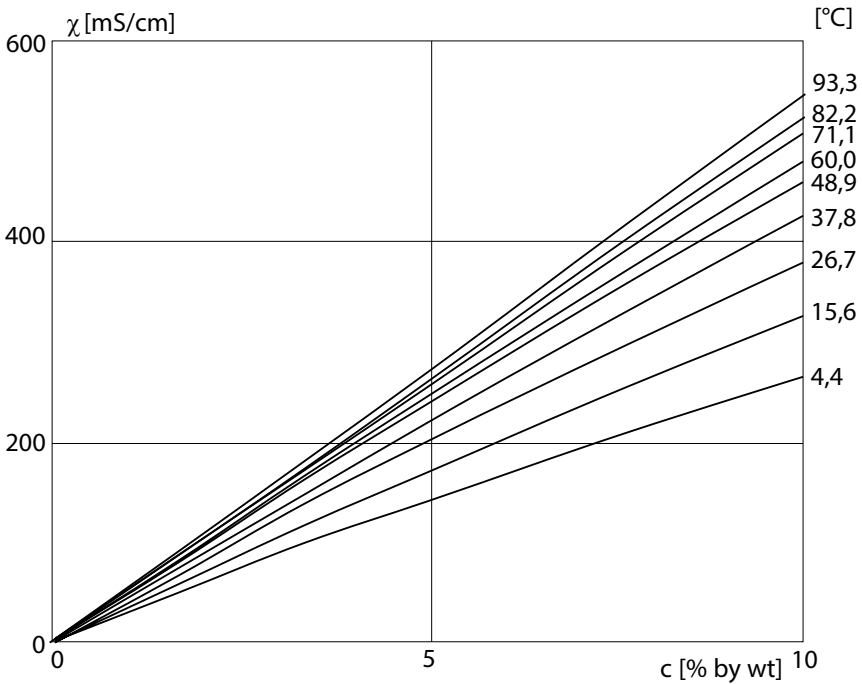

Conductivity versus substance concentration and process temperature for sulfuric acid ( $H_2SO_4$ )

Source: Darling; Journal of Chemical and Engineering Data; Vol.9 No. 3, July 1964

# Concentration Curves

---

## -05- Nitric acid $\text{HNO}_3$

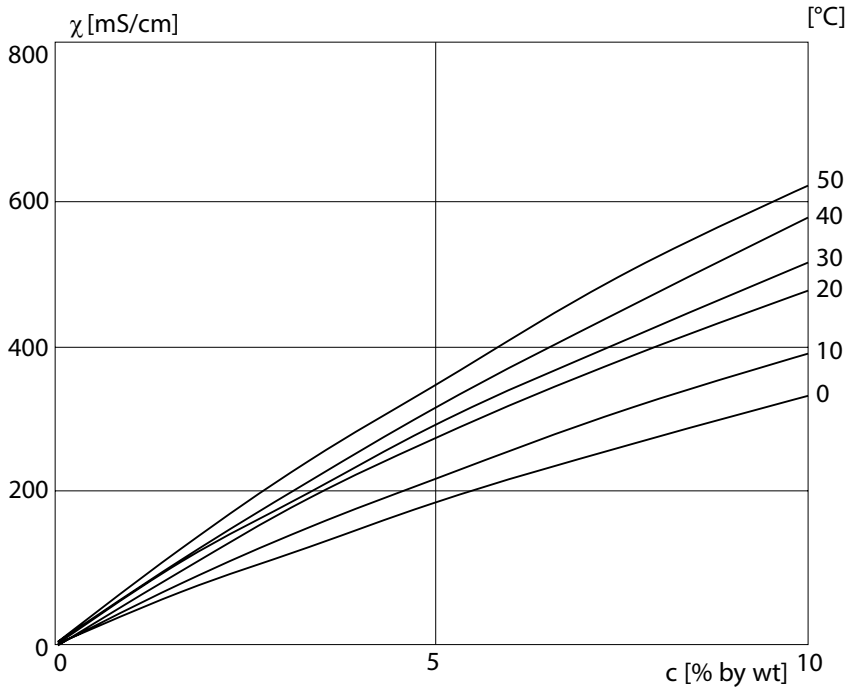

Conductivity versus substance concentration and process temperature for nitric acid ( $\text{HNO}_3$ )

Source: Haase/Sauermann/Dücker; Z. phys. Chem. New Edition, Vol. 47 (1965)



## Warnings and Notes to Ensure Safe Operation

### **WARNING!**

Do not disconnect equipment unless power has been switched off.

### **CAUTION!**

Clean only with antistatic moistened cloth.

### **CAUTION!**

Substitution of components may impair suitability for hazardous locations.

- The equipment shall be installed and protected from mechanical impact and ultraviolet (UV) sources.
- Clean only with a moistened antistatic cloth as potential electrostatic hazard may exist. Service equipment only with conductive clothing, footwear, and personal grounding devices to prevent electrostatic accumulation.
- Internal grounding provisions shall be provided for field wiring. Bonding between conduit shall be provided during installation, and all exposed non-current carrying metallic parts shall be bonded and grounded.
- The equipment shall have a switch or circuit breaker in the building installation (that is in close proximity to the equipment) that is marked as the disconnect switch.
- The enclosure Type 2 is only for indoor use.
- The mains supply voltage fluctuations should not exceed  $-15/+10$  percent of the nominal supply voltage.
- The device shall not be used in a manner not specified by this manual.

# Safe Operation

---

**CAUTION!**

Use supply wires suitable for 30 °C / 86 °F above ambient and rated at least 250 V.

**CAUTION!**

Use signal wires suitable for at least 250V.

22 mA signal for error message 45, 51

## A

Accessories 83

Alarm contact 55, 86

Alarm settings 27, 54

Assembly 10

## C

Calibration 64

by input of cell factor 66

Display of calibration data 76

Product calibration 70

with calibration solution 68

Zero calibration in air 72

Zero calibration with calibration solution 74

Calibration solutions 90

“Clean” contact 58

Concentration curves 92

Hydrochloric acid HCl 93

Nitric acid HNO<sub>3</sub> 96

Sodium chloride solution NaCl 92

Sodium hydroxide solution NaOH 94

Sulfuric acid H<sub>2</sub>SO<sub>4</sub> 95

Concentration measurement 39

Configuration 28

Menu structure 29

Configuration: Alarm settings 54

Configuration: Limit function 56

Configuration: Output 1

Output current during Error and HOLD 44

Output current range 40

Process variable 36

Sensor parameters, temperature probe 34

Sensor type 32

Solution for concentration measurement 38

Time constant of output filter 42

Configuration: Output 2  
    Output current 46  
    Output current during HOLD 50  
    Temperature 46  
    Temperature error 50  
    Time constant of output filter 48  
Configuration: Rinsing probes 58  
Configuration: Temperature compensation 52  
Connection 14  
Current start / end 41, 47

## **D**

Device self-test 25  
Diagnostics functions 76  
    Display of calibration data 76  
    Display of last error message 76  
    Display of output currents 76  
    Sensor monitor 76  
    Specifying the output current 77  
Display 23  
Disposal 2  
Division 2 wiring 15  
Documentation 8

## **E**

Error messages 78  
    Display of last error message 76  
Explosion protection 88

## **F**

Factory settings of parameters 60  
Front panel 22

## **H**

HOLD mode 26  
    Output signal during HOLD 45, 51  
Hysteresis 57

## **I**

Installation 14  
Intended use 7

## **K**

Keypad 24

## **M**

Measurement 75  
Mounting plan 11

## **O**

Operating states 80  
Output filter (attenuation) 43, 49  
Overview 9  
Overview of configuration steps 30

## **P**

Package contents 10  
Panel-mount kit 13  
Parameters  
    Factory settings 60  
    Individual settings 62  
Passcodes 103  
Pipe mounting 12  
Pipe-mount kit 12  
Product calibration 70  
Product line 83  
Protective hood 12  
Protective wiring 20

## **Q**

Quickstart guides 8

## **R**

Relay 56, 58  
Relay contacts 20  
Rinse contact 58  
Rinsing interval 59

# Index

---

Rinsing probes 58

Rinsing system 59

## S

Safe Operation 97

Safety information 5, 97

Self-test 25

Sensocheck 25, 54, 81

    Configuration 55

Sensoface 25, 81

Sensor connection 17

Sensor monitor 76

Shield connection 16

Short instructions 8

Special cable 16

Specifications 84

## T

Temperature compensation 52

Temperature probe 35

Temperature probe adjustment 75

Temperature unit 47

Terminal assignments 14

Time constant of output filter 43, 49

Trademarks 7

## U

User interface 22

## W

Wiring examples 17

## Z

Zero calibration in air 72

Zero calibration with calibration solution 74

## Calibration

Key + passcode	Menu item	Page
cal + 0000	CAL info (display of cell factor, slope)	76
cal + 1100	Cell factor adjustment	66
cal + 0110	Calibration (with standard solution)	68
cal + 1105	Product calibration	70
cal + 1001	Calibration (zero point e.g. in air)	72
cal + 1015	Temp probe adjustment	75

## Configuration

Key + passcode	Menu item	Page
conf + 0000	Error info (display of last error, erase)	76
conf + 1200	Configuration	28
conf + 2222	Sensor monitor	76
conf + 5555	Current source 1 (specify output current)	77
conf + 5556	Current source 2 (specify output current)	77
conf + ▶ + 4321	Factory setting	60



**Knick**  
**Elektronische Messgeräte**  
**GmbH & Co. KG**

**Headquarters**

Beuckestraße 22 • 14163 Berlin

Germany

Phone: +49 30 80191-0

Fax: +49 30 80191-200

info@knick.de

www.knick.de

**Local Contacts**

www.knick-international.com

Copyright 2020 • Subject to change

This document was last updated on Nov. 16, 2020

The latest documents are available for download on our website  
under the corresponding product description.



097803

TA-194.333-KNEN05

Software version: 2.x