

Subject to change without notice.

Return of Products Under Warranty

Please contact our Service Team before returning a defective device. Ship the cleaned device to the address you have been given. If the device has been in contact with process fluids, it must be decontaminated/disinfected before shipment. In that case, please attach a corresponding certificate, for the health and safety of our service personnel.

Disposal

Please observe the applicable local or national regulations concerning the disposal of "waste electrical and electronic equipment".

Knick

Elektronische Messgeräte GmbH & Co. KG

Beuckestraße 22

14163 Berlin

Germany

Phone: +49 30 80191-0

Fax: +49 30 80191-200

Web: www.knick.de

Email: info@knick.de

Table of Contents

Safety Information	5
Intended Use.....	7
Registered Trademarks.....	7
Provided Documentation	8
Overview of Stratos Eco 2405 Oxy.....	9
Assembly.....	10
Package Contents.....	10
Mounting Plan.....	11
Pipe Mounting, Panel Mounting.....	12
Installation and Connection.....	14
Installation Instructions	14
Terminal Assignments	14
Wiring Example.....	17
Sensors with Connection via VP Cable	17
Protective Wiring of Relay Outputs	18
User Interface and Display	20
Operation: Keypad	22
Safety Functions	23
Sensocheck, Sensoface Sensor Monitoring.....	23
GainCheck Device Self-Test.....	23
Automatic Device Self-Test	23
Hold Mode	24
Configuration	26
Menu Structure of Configuration	27
Overview of Configuration Steps	28
Output 1	30
Output 2	38
Correction	44
Calibration Mode.....	46
Alarm Settings.....	48

Table of Contents

Limit Function.....	50
Controlling a Rinsing System.....	52
Connecting a Rinsing System.....	53
Parameters.....	54
Factory Settings of Parameters	54
Parameters – Individual Settings.....	56
Calibration	58
Calibration to Percent Saturation (SAT), in Water.....	60
Calibration to Concentration (Conc), in Air	62
Zero Calibration	64
Product Calibration	66
Temp Probe Adjustment	69
Measurement	69
Diagnostics Functions	70
Error Messages (Error Codes)	72
Calibration Error Messages	74
Operating States.....	75
Sensoface	77
Appendix.....	81
Product Line and Accessories.....	81
Specifications.....	82
Safe Operation.....	87
Index	89
Passcodes	93

Safety information –

Be sure to read and observe the following instructions!

The device has been manufactured using state of the art technology and it complies with applicable safety regulations.

When operating the device, certain conditions may nevertheless lead to danger for the operator or damage to the device.

CAUTION!

Commissioning must be carried out by trained experts.

Whenever it is likely that protection has been impaired, the device shall be made inoperative and secured against unintended operation.

The protection is likely to be impaired if, for example:

- the device shows visible damage
- the device fails to perform the intended measurements
- after prolonged storage at temperatures above 70°C / 158 °F
- after severe transport stresses

Before recommissioning the device, a professional routine test in accordance with EN 61010-1 must be performed. This test should be carried out at the manufacturer's factory.

CAUTION!

Before commissioning, make sure that the transmitter may be connected with the other equipment.

Intended Use

Stratos Eco 2405 Oxy is used for dissolved oxygen and temperature measurement in biotechnology, pharmaceutical industry, as well as in the field of environment, food processing, and sewage treatment. The sturdy molded enclosure can be fixed into a control panel or mounted on a wall or at a post.

The protective hood provides additional protection against direct weather exposure and mechanical damage.

The device has been designed for application with amperometric sensors, e.g. Knick SE 703 / SE 706. It provides two current outputs (for transmission of measured value and temperature, for example), two contacts, and a universal power supply 24 ... 230 V AC/DC, AC: 45 ... 65 Hz.

Registered Trademarks

The following names are registered trademarks. For practical reasons they are shown without trademark symbol in this manual.

Stratos®

Sensocheck®

Sensoface®

Calimatic®

GainCheck®

Provided Documentation

Safety Instructions

In official EU languages and others.

Quickstart Guides

In German, English, French, Russian, Finnish, Swedish, Spanish, Portuguese, and Chinese.

- Installation and Commissioning
- Operation
- Menu structure
- Calibration
- Error messages and recommended actions

Test Report 2.2

according to EN 10204

Overview of Stratos Eco 2405 Oxy

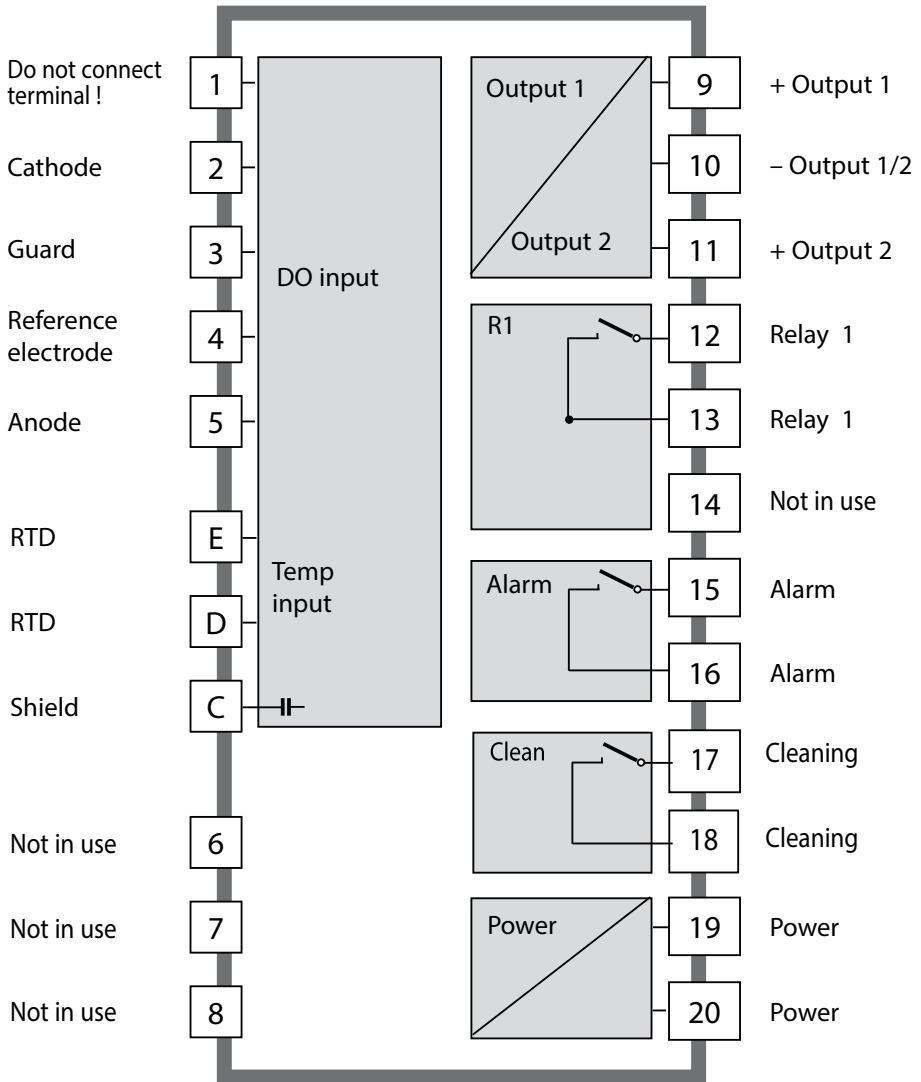

Assembly

Package Contents

Check the shipment for transport damage and completeness.
The package should contain:

- Front unit
- Rear unit
- Bag containing small parts
- Documentation
- Passcode sticker

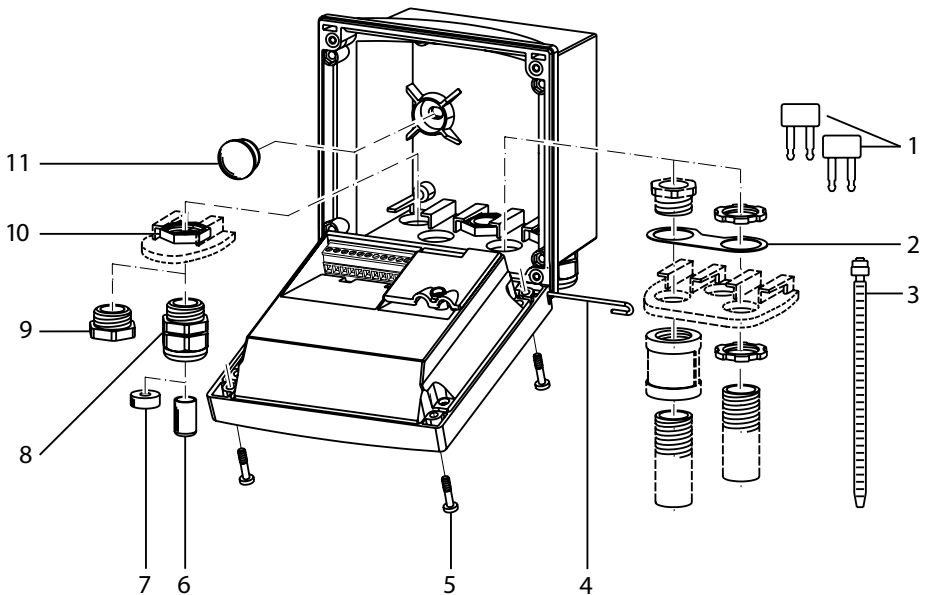

- | | |
|---|---|
| 1 Jumper (2 x) | 6 Sealing insert (1 x) |
| 2 Washer (1 x), for conduit mounting:
Place washer between enclosure and nut | 7 Rubber reducer (1 x) |
| 3 Cable tie (3 x) | 8 Cable gland (3 x) |
| 4 Hinge pin (1 x), insertable from either side | 9 Filler plug (3 x) |
| 5 Enclosure screw (4 x) | 10 Hexagon nut (5 x) |
| | 11 Sealing plug (2 x), for sealing in case of wall mounting |

Fig.: Assembling the enclosure

Mounting Plan

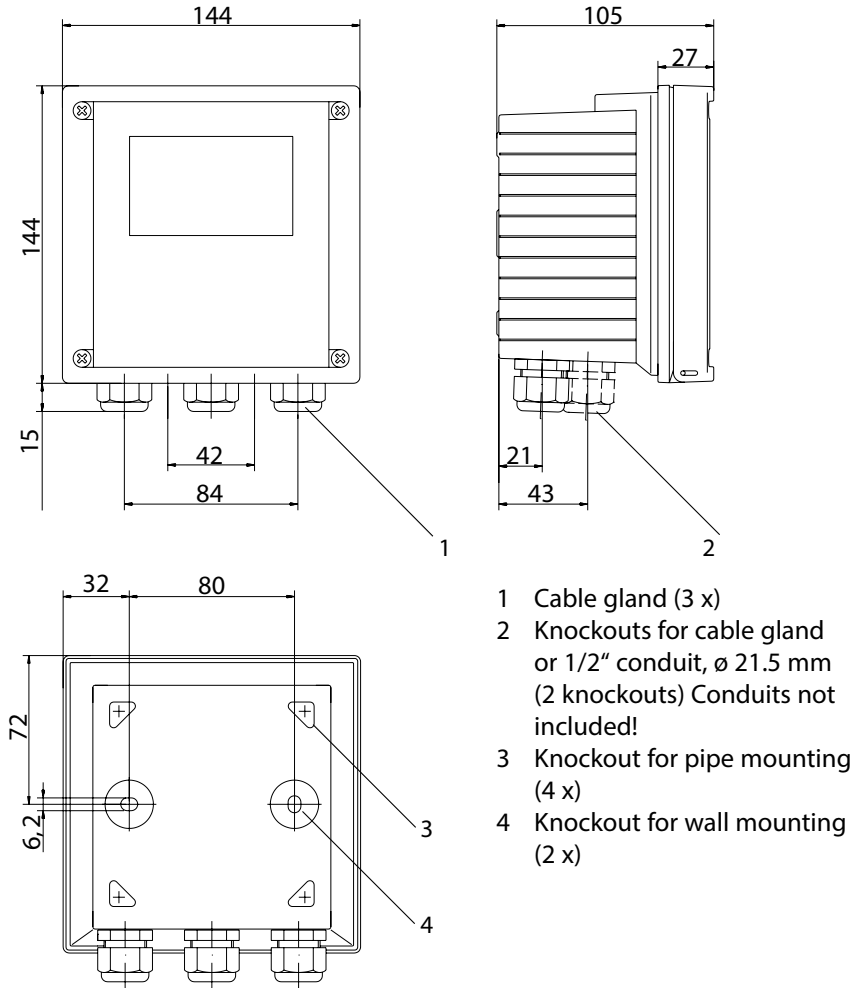
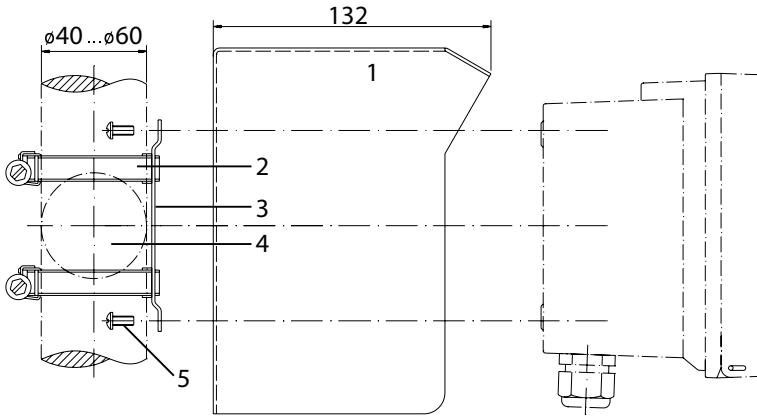

Fig.: Mounting plan (All dimensions in mm!)

Pipe Mounting, Panel Mounting



- 1 ZU 0276 protective hood (if required)
- 2 Hose clamp with worm gear drive to DIN 3017 (2 x)
- 3 Pipe-mount plate (1 x)
- 4 For vertical or horizontal posts or pipes
- 5 Self-tapping screw (4 x)

Fig.: ZU 0274 pipe-mount kit (All dimensions in mm!)

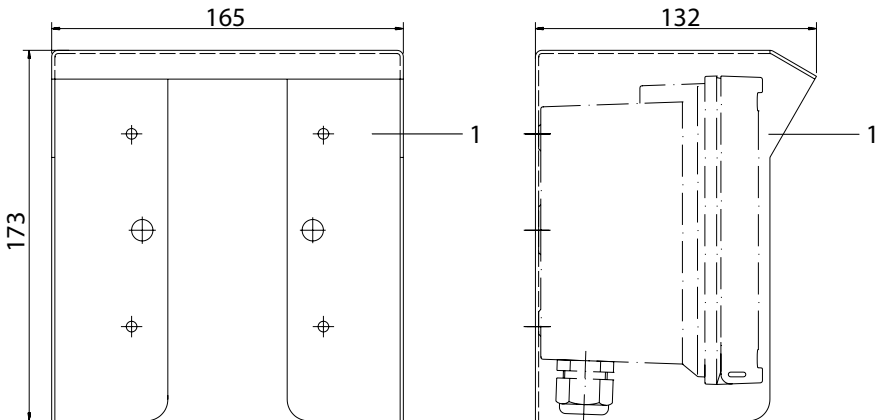
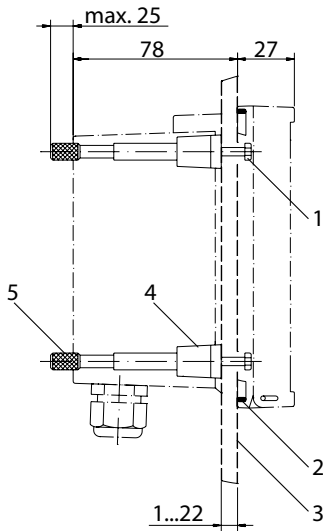

Fig.: ZU 0276 protective hood for wall and pipe mounting
(All dimensions in mm!)



- 1 Screw (4 x)
- 2 Gasket (1 x)
- 3 Control panel
- 4 Span piece (4 x)
- 5 Threaded sleeve (4 x)

Panel cut-out
138 x 138 mm (DIN 43700)

Fig.: ZU 0275 panel-mount kit (All dimensions in mm!)

Installation and Connection

Installation Instructions

CAUTION!

- Installation of the Stratos must be carried out by trained experts in accordance with this user manual and as per applicable local and national codes.
- Be sure to observe the technical specifications and input ratings during installation.
- Be sure not to notch the conductor when stripping the insulation.
- Before connecting the device to the power supply, make sure that its voltage lies within the range 20.5 to 253V AC/DC.
- All parameters must be set by a system administrator prior to commissioning.

The terminals are suitable for single wires and flexible leads up to 2.5 mm² (AWG 14).

Terminal Assignments

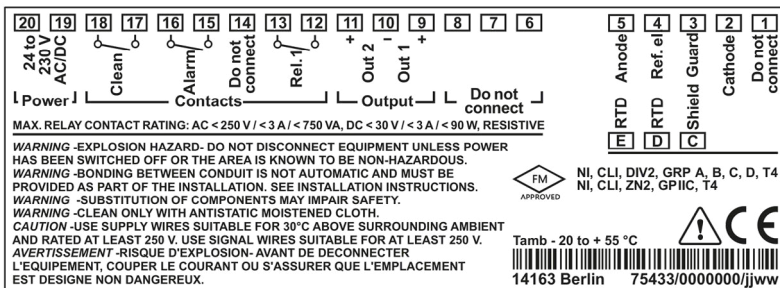
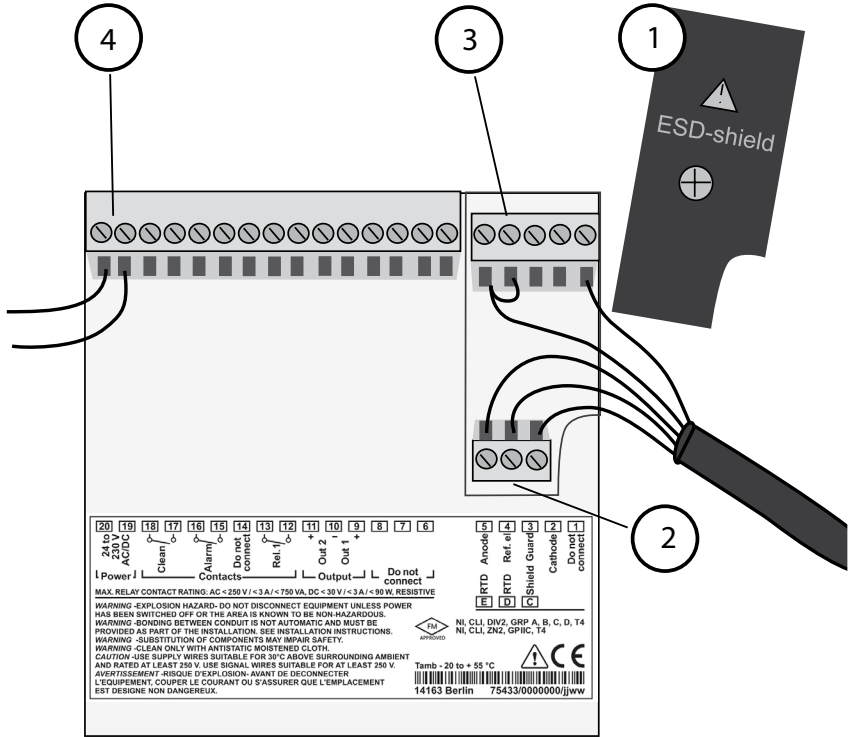

Fig.: Stratos Eco 2405 Oxy terminal assignments



- 1 ESD shield covering the signal inputs (Screw off for assembly)
Note: The cable shield must end under the ESD shield. (Cut lines if required.)
- 2 Terminals for temperature probe
- 3 Terminals for sensor
- 4 Power supply connection

Fig.: Information on installation, rear side of device

Division 2 Wiring



The connections to the device must be installed in accordance with the National Electric Code (ANSI NFPA 70) Division 2 hazardous (classified) location non-incendive wiring techniques.

Wiring Example

Sensors with Connection via VP Cable

Stratos Eco 2405 Oxy

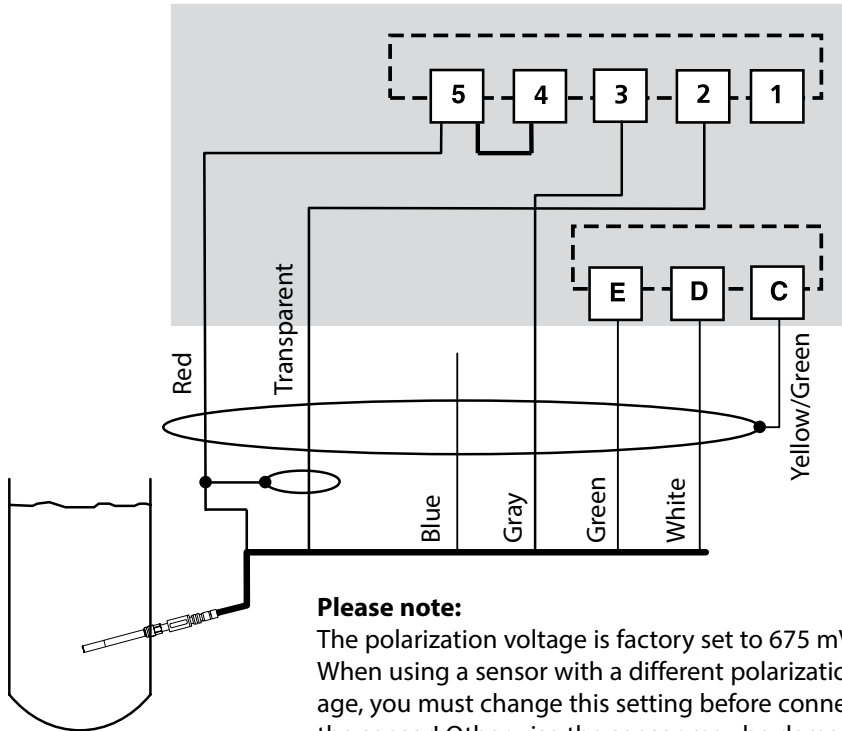

Please note:

The polarization voltage is factory set to 675 mV. When using a sensor with a different polarization voltage, you must change this setting before connecting the sensor! Otherwise the sensor may be damaged!

Connection	Terminal	SE 703/SE 706 sensor VP cable (e.g. ZU 0313)
	1	Do not connect!
cathode	2	Transparent (coax core)
guard	3	Gray
ref. el.	4	(Jumper 4-5)
anode	5	Red (coax shield)
RTD	E	Green
RTD	D	White
shield	C	Yellow/Green

Protective Wiring of Relay Outputs

Protective Wiring of Relay Contacts

Relay contacts are subjected to electrical erosion. Especially with inductive and capacitive loads, the service life of the contacts will be reduced. For suppression of sparks and arcing, components such as RC combinations, nonlinear resistors, series resistors and diodes should be used.

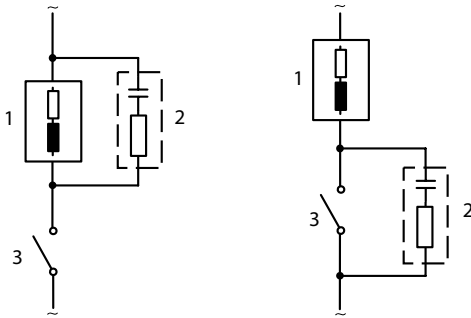

AC applications with inductive load

- 1 Load
- 2 RC combination, e.g. RIFA PMR 209
Typical RC combinations for 230 V AC:
Capacitor 0.1 μF / 630 V Resistor 100 ohms / 1 W
- 3 Contact

Typical Protective Wiring Measures

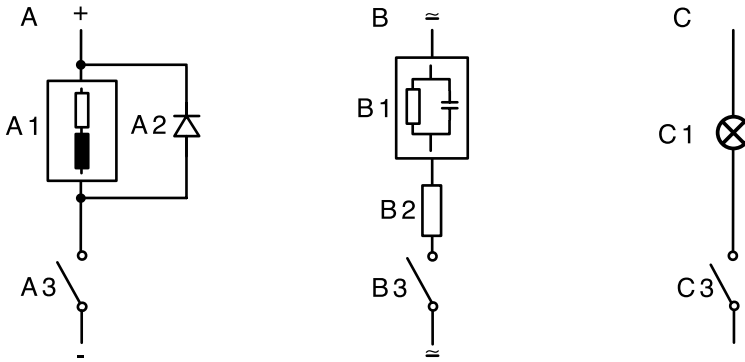

A: DC application with inductive load

B: AC/DC applications with capacitive load

C: Connection of incandescent lamps

A1 Inductive load

A2 Free-wheeling diode, e.g. 1N4007 (Observe polarity)

A3 Contact

B1 Capacitive load

B2 Resistor, e.g. 8Ω / 1 W at 24 V / 0.3 A

B3 Contact

C1 Incandescent lamp, max 60 W / 230 V, 30 W / 115 V

C3 Contact

WARNING!

Make sure that the maximum ratings of the relay contacts are not exceeded even during switching!

User Interface and Display

User Interface

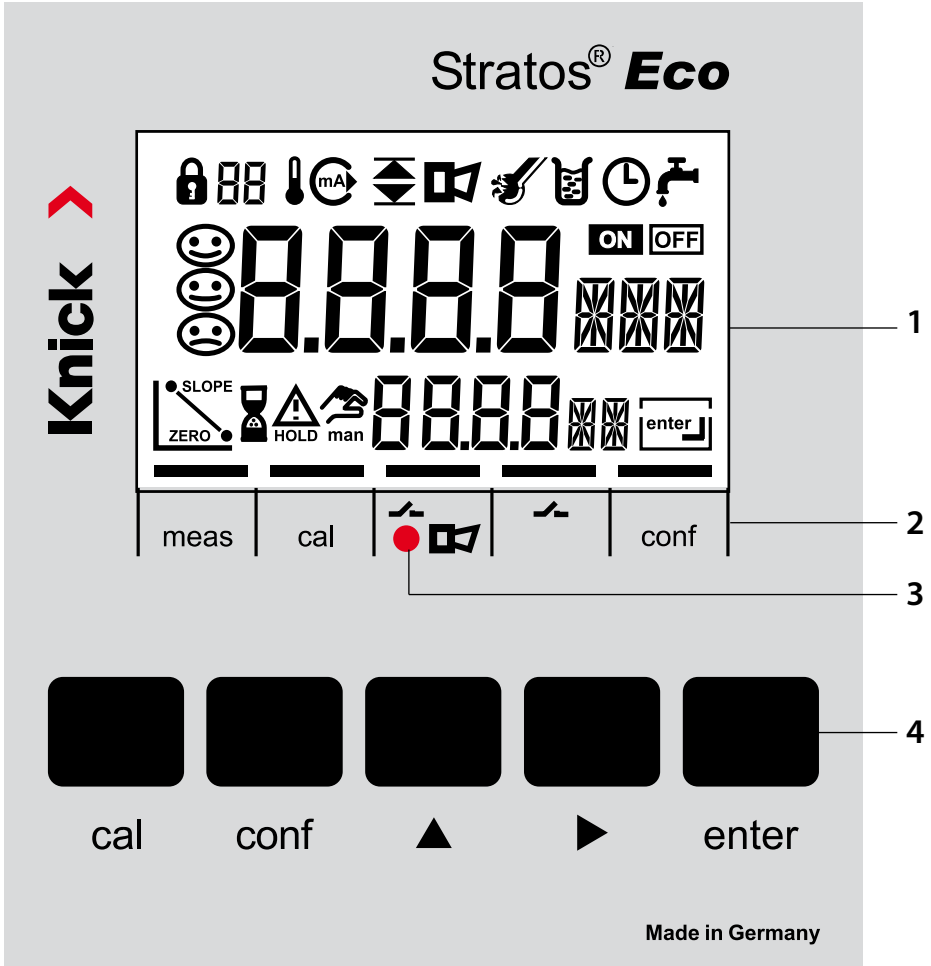

- 1 Display
- 2 Mode indicators (no keys), from left to right:
 - Measuring mode
 - Calibration mode
 - Alarm
 - Cleaning contact
 - Configuration mode
- 3 Alarm LED
- 4 Keypad

Display

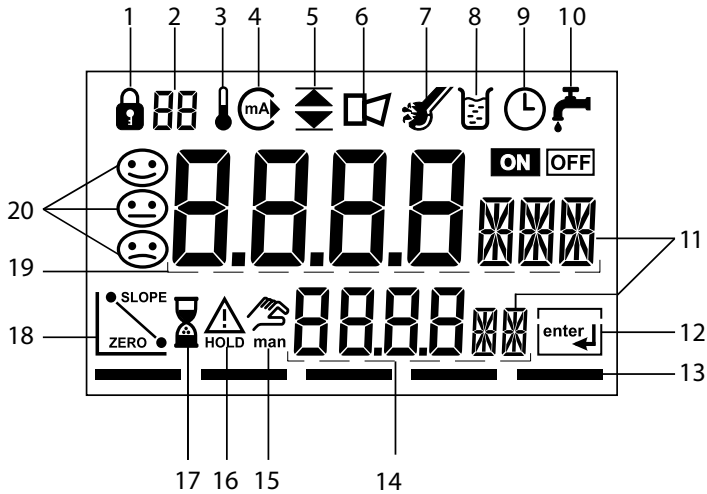

- | | | | |
|----|---|----|----------------------------------|
| 1 | Passcode entry | 14 | Secondary display |
| 2 | Not in use | 15 | Manual temperature specification |
| 3 | Temperature | 16 | Hold mode active |
| 4 | Current output | 17 | Waiting time running |
| 5 | Limit values | 18 | Sensor data |
| 6 | Alarm | 19 | Main display |
| 7 | Sensocheck | 20 | Sensoface |
| 8 | Calibration | | |
| 9 | Interval/response time | | |
| 10 | Cleaning contact | | |
| 11 | Measurement symbol | | |
| 12 | Press enter to proceed | | |
| 13 | Bar for identifying the device status, above mode indicators, from left to right: | | |
| | - Measuring mode | | |
| | - Calibration mode | | |
| | - Alarm | | |
| | - Not in use | | |
| | - Configuration mode | | |

User Interface and Display

Operation: Keypad

cal	Start, exit calibration
conf	Start, exit configuration
▶	<ul style="list-style-type: none">• Select digit position (selected position blinks)• Menu navigation
▲	<ul style="list-style-type: none">• Edit digit• Menu navigation
enter	<ul style="list-style-type: none">• Calibration: Continue in program sequence• Configuration: Confirm entries, next configuration step• Measuring mode: Display output current

cal → enter	Cal Info: Display of zero point and slope
conf → enter	Error Info: Display of last error message
▶ + ▲	Start GainCheck device self-test

Sensocheck, Sensoface Sensor Monitoring

Sensocheck continuously monitors the sensor and its wiring. Sensocheck can be switched off (Configuration, page 48).



Sensoface provides information on the sensor condition. The slope and response time during calibration are evaluated. The three Sensoface indicators provide the user with information on wear and required maintenance of the sensor.

GainCheck Device Self-Test

A display test is carried out, the software version is displayed, and the memory and measured-value transfer are checked.

Start GainCheck device self-test: ▶ + ▲

Automatic Device Self-Test

The automatic device self-test checks the memory and measured-value transfer. It runs automatically in the background at fixed intervals.

Safety Functions

Hold Mode

Display: 

The Hold mode is a safety state during configuration and calibration. Output current is frozen (Last) or set to a fixed value (Fix). Alarm and limit contacts are disabled.

If the calibration or configuration mode is exited, the device remains in the Hold mode for safety reasons. This prevents undesirable reactions of the connected peripherals due to incorrect configuration or calibration. The measured value and "HOLD" are displayed alternately. The device only returns to measuring mode after **enter** is pressed and 20 seconds have passed.

Configuration mode is also exited automatically 20 minutes (timeout) after the last keystroke. The device returns to measuring mode.

Timeout is not active during calibration.

Behavior of output signal:

- Last:** The output current is frozen at its last value.
Recommended for short configuration procedures.
The process should not change decisively during configuration.
Changes are not noticed with this setting!
- Fix:** The output current is set to a value that is noticeably different from the process value in order to signal the control system that the device is being worked at.

See Configuration page 36.

Alarm

Alarm delay is 10 seconds.

During an error message the alarm LED blinks.

Error messages can also be signaled by a 22 mA output current.

The alarm contact is activated by alarm or power failure, see also page 49.

Configuration

In the Configuration mode you set the device parameters.

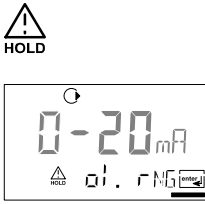
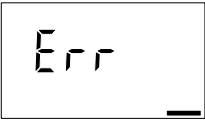
Activation	conf	Activate using conf
		Enter passcode "1200" Edit parameter using ▶ and ▲ , confirm/proceed using enter . (Exit by pressing conf , then enter .)
HOLD During configuration the device remains in the Hold mode.	 ↑ HOLD icon	The output current is frozen (at its last value or at a preset fixed value, depending on the configuration), limit and alarm contacts are inactive. Sensoface is off, "Configuration" mode indicator is on.
Input errors		The configuration parameters are checked during the input. In the case of an incorrect input "Err" is displayed for approx. 2 sec. The incorrect parameters cannot be stored. Input must be repeated.
Exit	conf enter	Exit by pressing conf . The measured value and Hold are displayed alternately, "enter" blinks. Press enter key to exit the Hold mode. The measured value is displayed. The output current remains frozen for another 20 sec (HOLD icon on, "hourglass" blinks).

Menu Structure of Configuration

The configuration steps are assigned to different menu groups. Using the arrow keys, you can jump between the individual menu groups.

Each menu group contains menu items for setting the parameters. Pressing **enter** opens a menu item.

The values are edited using the arrow keys.

Pressing **enter** confirms/saves the settings.

Return to measurement: Press **conf**.

Select menu group	Menu group	Code	Display	Select menu item
▶	Output 1	o1.		↵ enter ↵ enter ↵ enter ↵ enter
		Menu item 1		
		Menu item 2		
		:		
		Menu item ...		
▶	Output 2	o2.		
▶	Correction	Co.		
▶	Calibration mode	CA.		
▶	Alarm settings	AL.		
▶	Relay	rL.		
▶	Rinsing probes	Pb.		↻ Previous menu group: ↵

Configuration

Overview of Configuration Steps

Code	Menu	Selection
out1	Output 1	
o1.SnSR	Select sensor type	Standard (Type A) / Sensors with higher current (Type B)
o1.UnIT	Select saturation / concentration	% / mg/l, ppm
o1.rNG	Select current range	0-20 mA / 4-20 mA
o1. 4mA	Enter current start	xxxx
o1.20mA	Enter current end	xxxx
o1.FtME	Time constant of output filter	xxxx sec
o1.FAIL	22 mA signal in the case of error	ON / OFF
o1.HoLD	Signal behavior during HOLD	Last / Fix
o1.FIX	Enter fixed value	xxx.x mA
out2	Output 2	
o2.UnIT	Select temperature unit	°C / °F
o2.rTD	Select temperature probe	22NTC / 30NTC
o2.rNG	Select current range	0-20 mA / 4-20 mA
o2. 4mA	Enter current start	xxx.x
o2.20mA	Enter current end	xxx.x
o2.FtME	Time constant of output filter	xxxx sec
o2.FAIL	22 mA signal for temp error	ON / OFF
o2.HoLD	Signal behavior during HOLD	Last / Fix
	Enter fixed value	xxx.x mA
Corr	Correction	
Co.UPOL	Enter polarization voltage	0675 mV / xxxx mV
Co.CAp	Enter factor for membrane temperature compensation	Default: 01.00
Co.UnIT	Select pressure unit	bar / kPa / PSI
Co.PrES	Select process pressure correction	x.xxx bar / 1.013 bar
Co.SAL	Enter salinity correction	xx.xx mg/l

Code	Menu	Selection
CAL	Calibration mode	
Ca.MOD	Select saturation / concentration	SAt / Conc
CA.tiME	Enter cal timer interval	xxxx h
ALrt	Alarm settings	
AL.SnSO	Select Sensocheck	ON / OFF
rLAY	Relay 1: Limit	
L1.FCT	Select contact function	Lo / Hi
L1.tYP	Select contact response	N/O / N/C
L1.LEVL	Enter setpoint	xxxx
L1.HYS	Enter hysteresis	xxxx
L1.dLY	Enter delay	xxxx SEC
PrbE	Rinsing probes	
Pb.InTV	Rinse interval	000.0 h
Pb.rins	Rinse duration	xxxx SEC
Pb.typ	Contact response	N/C / N/O

Configuration

Output 1

Select sensor type. Process variable

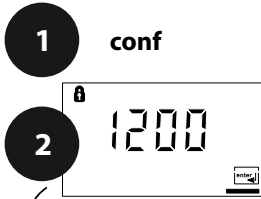

Output 1:

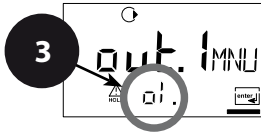



- 1 Press **conf** key.
- 2 Enter passcode **1200**.
- 3 **Output 1** menu group is displayed. All items of this menu group are indicated by the "01." code.
- 4 Press **enter** to select menu, edit using arrow keys (see page 31). Confirm (and proceed) by pressing **enter**.
- 5 Exit: Press **conf**, then **enter**.

enter	4	enter
→	o1.SnSR Select sensor type*	←
	o1.UnIT Select process variable	
	o1.rNG Select 0-20 / 4-20 mA	
	o1.4mA Enter current start	
	o1.20mA Enter current end	
	o1.FtME Set output filter	
	o1.FAIL 22 mA for error	
	o1.HoLD HOLD mode	

5 **conf enter**

* Sensor type		Sensor cap	Sensor current in air (25 °C)	Detection limit
A	SE 703	VP	40 ... 110 nA	0.03 ppm
	SE 706	VP	50 ... 110 nA	0.006 ppm
B (sensors with higher current)			290 ... 500 nA	

Note: Stratos Eco 2405 Oxy has as device a resolution of 0.01 ppm.

Code	Display	Action	Choices
01.		Select sensor type A / B (see table on left-hand side) Select using ▶ . Press enter to proceed.	Type A (SE 703/ SE 706) Type B (sensors with higher current)
	 	Select process variable (valid for all following settings): <ul style="list-style-type: none"> • SA: Saturation (%) • Conc: Concentration (mg/l or ppm) Select using ▶ . Press enter to proceed.	% mg/l ppm

Note: Characters represented in gray are blinking and can be edited.

Configuration

Output 1

Output current range, current start, current end

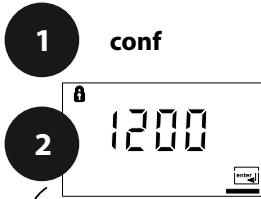

Output 1:

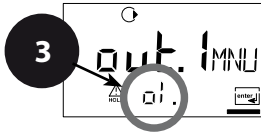



- 1 Press **conf** key.
- 2 Enter passcode **1200**.
- 3 **Output 1** menu group is displayed. All items of this menu group are indicated by the "o1." code.
- 4 Press **enter** to select menu, edit using arrow keys (see page 33). Confirm (and proceed) by pressing **enter**.
- 5 Exit: Press **conf**, then **enter**.

o1.SnSR	Select sensor type
o1.UnIT	Select process variable
o1.rNG	Select 0-20 / 4-20 mA
o1.4mA	Enter current start
o1.20mA	Enter current end
o1.FtME	Set output filter
o1.FAIL	22 mA for error
o1.HoLD	HOLD mode



conf **enter**

Code	Display	Action	Choices
o1.		Set output current range Select using ▶ key, press enter to proceed.	4-20 mA (0 - 20 mA)
		Current start Enter lower end of scale. Select using ▶ key, edit number using ▲ key. Press enter to proceed.	000.0 % (mg/l, ppm)
		Current end Enter upper end of scale, depending on process variable selected (saturation or concentration) Press enter to proceed.	200.0 % (mg/l, ppm)

Assignment of Measured Values: Current Start and Current End

Example 1: Range 0 ... 100 %

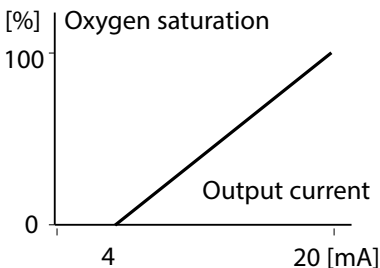

Example 2: Range 50 ... 70%.

Advantage: Higher resolution in range of interest

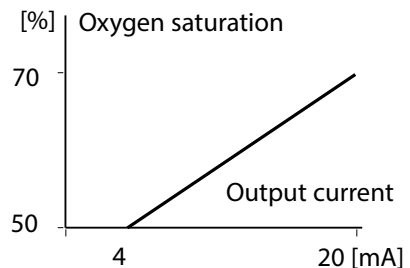

Configuration

Output 1

Time constant of output filter

1 **conf**



2

Output 1:

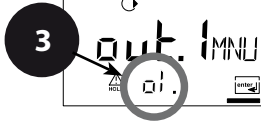

3

- 1 Press **conf** key.
- 2 Enter passcode **1200**.
- 3 **Output 1** menu group is displayed. All items of this menu group are indicated by the "o1." code.
- 4 Press **enter** to select menu, edit using arrow keys (see page 35). Confirm (and proceed) by pressing **enter**.
- 5 Exit: Press **conf**, then **enter**.

enter →

o1.SnSR	Select sensor type
o1.UnIT	Select process variable
o1.rNG	Select 0-20 / 4-20 mA
o1.4mA	Enter current start
o1.20mA	Enter current end
o1.FtME	Set output filter
o1.FAIL	22 mA for error
o1.HoLD	HOLD mode

4

enter



5

conf enter

Code	Display	Action	Choices
o1.		Time constant of output filter Default setting: 0 s (inactive). To specify a time constant: Select using ► key, edit number using ▲ key. Press enter to proceed.	0 sec 0 ... 120 sec

Time Constant of Output Filter (Attenuation)

To smoothen the current output, a low-pass filter with adjustable filter time constant can be switched on. When there is a jump at the input (100 %), the output level is at 63 % after the time constant has been reached.

The time constant can be set from 0 to 120 sec.

If the time constant is set to 0 sec, the current output follows the input.

Please note:

The filter only acts on the current output, not on the display or the limit value!

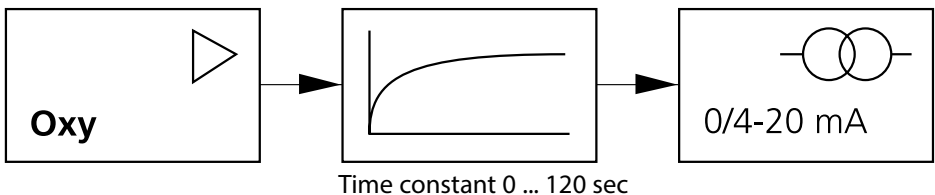

Configuration

Output 1

Output current during Error and HOLD

1 **conf**



2
Output 1:

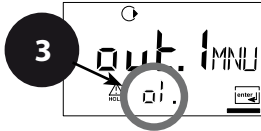

- 1 Press **conf** key.
- 2 Enter passcode **1200**.
- 3 **Output 1** menu group is displayed. All items of this menu group are indicated by the "o1." code.
- 4 Press **enter** to select menu, edit using arrow keys (see page 37). Confirm (and proceed) by pressing **enter**.
- 5 Exit: Press **conf**, then **enter**.

enter →

o1.SnSR	Select sensor type
o1.UnIT	Select process variable
o1.rNG	Select 0-20 / 4-20 mA
o1.4mA	Enter current start
o1.20mA	Enter current end
o1.FtME	Set output filter
o1.FAIL	22 mA for error
o1.HoLD	HOLD mode

4

enter
↩
↩

5

conf enter

Code	Display	Action	Choices
o1.		22 mA signal for error message Select using ▶ key, press enter to proceed.	OFF (OFF / ON)
		Output signal during HOLD LAST: During HOLD the last measured value is maintained at the output FIX: During HOLD a value (to be entered) is maintained at the output Select using ▶ key, press enter to proceed.	LAST (LAST / FIX)
		Only with FIX selected: Enter current which is to flow at the output during HOLD Select position using ▶ key and edit number using ▲ key. Press enter to proceed.	21.0 mA (00.0 ... 21.0 mA)

Output Signal During HOLD:

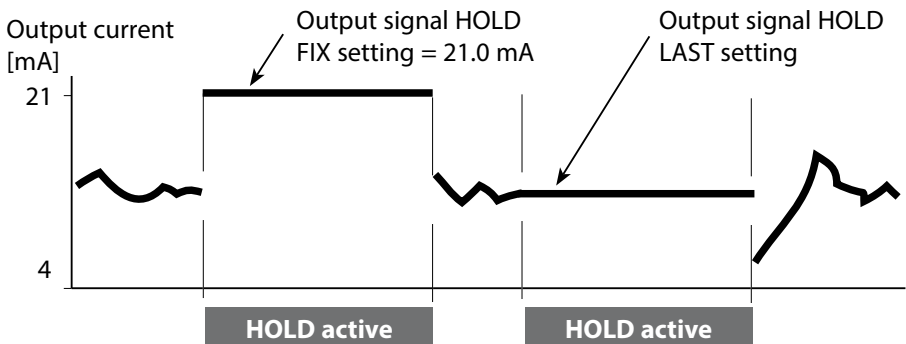

Configuration

Output 2

Temperature unit and probe, output current

1 **conf**

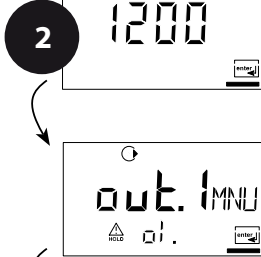

Output 2:

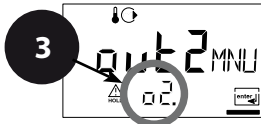

enter

- 1 Press **conf** key.
- 2 Enter passcode **1200**.
- 3 Select **Output 2** menu group using arrow keys. All items of this menu group are indicated by the "o2." code.
- 4 Press **enter** to select menu, edit using arrow keys (see page 39). Confirm (and proceed) by pressing **enter**.
- 5 Exit: Press **conf**, then **enter**.





4

o2.UnIT	Select °C/°F
o2.rTD	Select temp probe
o2.rNG	Select 0-20 / 4-20 mA
o2. 4mA	Enter current start
o2.20mA	Enter current end
o2.FtME	Set output filter
o2.FAIL	22 mA for temp error
o2.HoLD	HOLD mode

enter

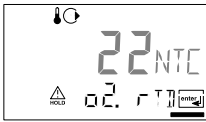
5

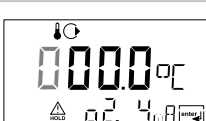
conf enter

Code	Display	Action	Choices
o2.		Specify temperature unit Select using ▶ key, press enter to proceed.	°C (°C / °F)
		Select temperature probe Select using ▶ key, press enter to proceed.	22NTC (30NTC)
		Select output current range Select using ▶ key, press enter to proceed.	4 - 20 mA (4 - 20 mA/ 0 - 20 mA)
		Current start: Enter lower end of scale. Select using ▶ key, edit number using ▲ key. Press enter to proceed.	000.0 °C (xxx.x °C)
		Current start: Enter upper end of scale. Select using ▶ key, edit number using ▲ key. Press enter to proceed.	100.0 °C (xxx.x °C)

Process Temperature: Current Start and Current End

Example 1: Range 0 ... 100 °C

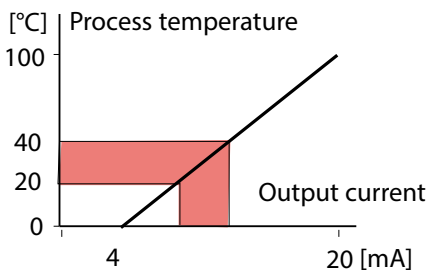

Example 2: Range 20 ... 40 °C
Advantage: Higher resolution in
range of interest

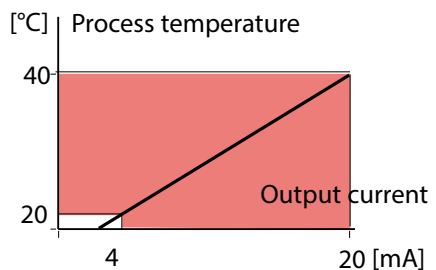

Configuration

Output 2

Time constant of output filter

1 **conf**

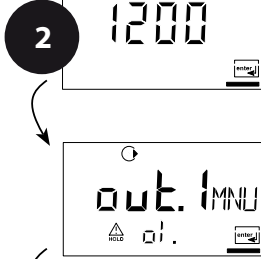

Output 2:

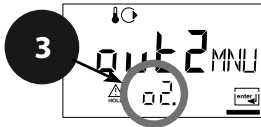

- 1 Press **conf** key.
- 2 Enter passcode **1200**.
- 3 Select **Output 2** menu group using arrow keys. All items of this menu group are indicated by the "o2." code.
- 4 Press **enter** to select menu, edit using arrow keys (see page 41). Confirm (and proceed) by pressing **enter**.
- 5 Exit: Press **conf**, then **enter**.

enter

o2.UnIT	Select °C/°F
o2. rTD	Select temp probe
o2.rNG	Select 0-20 / 4-20 mA
o2. 4mA	Enter current start
o2.20mA	Enter current end
o2.FtME	Set output filter
o2.FAIL	22 mA for temp error
o2.HoLD	HOLD mode

enter

5

conf enter

Code	Display	Action	Choices
o2.		Time constant of output filter Default setting: 0 sec (inactive). To specify a time constant: Select using ▶ key, edit number using ▲ key. Press enter to proceed.	0 sec (0 ... 120 sec)

Time Constant of Output Filter

To smoothen the current output, a low-pass filter with adjustable filter time constant can be switched on. When there is a jump at the input (100 %), the output level is at 63 % after the time constant has been reached.

The time constant can be set from 0 to 120 sec.

If the time constant is set to 0 sec, the current output follows the input.

Please note:

The filter only acts on the current output, not on the display!



Configuration

Output 2

Temperature error, output current during HOLD

1 **conf**

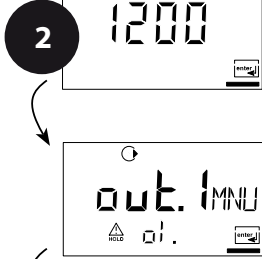

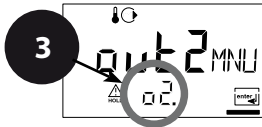

Output 2:



- 1 Press **conf** key.
- 2 Enter passcode **1200**.
- 3 Select **Output 2** menu group using arrow keys. All items of this menu group are indicated by the "o2." code.
- 4 Press **enter** to select menu, edit using arrow keys (see page 43). Confirm (and proceed) by pressing **enter**.
- 5 Exit: Press **conf**, then **enter**.

o2.UnIT	Select °C/°F	enter ↻ ↻
o2. rTD	Select temp probe	
o2.rNG	Select 0-20 / 4-20 mA	
o2. 4mA	Enter current start	
o2.20mA	Enter current end	
o2.FtME	Set output filter	
o2.FAIL	22 mA for temp error	
o2.HoLD	HOLD mode	

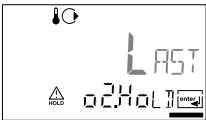
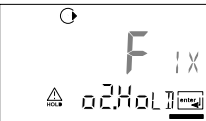
5 **conf enter**

Code	Display	Action	Choices
o2.		22 mA signal for error message Select using ▶ key, press enter to proceed.	OFF (OFF / ON)
		Output signal during HOLD LAST: During HOLD the last measured value is maintained at the output FIX: During HOLD a value (to be entered) is maintained at the output Select using ▶ key, press enter to proceed.	LAST (LAST / FIX)
		Only with FIX selected: Enter current which is to flow at the output during HOLD Select position using ▶ key and edit number using ▲ key. Press enter to proceed.	21.0 mA (00.0 ... 21.0 mA)
			

Output Signal During HOLD:

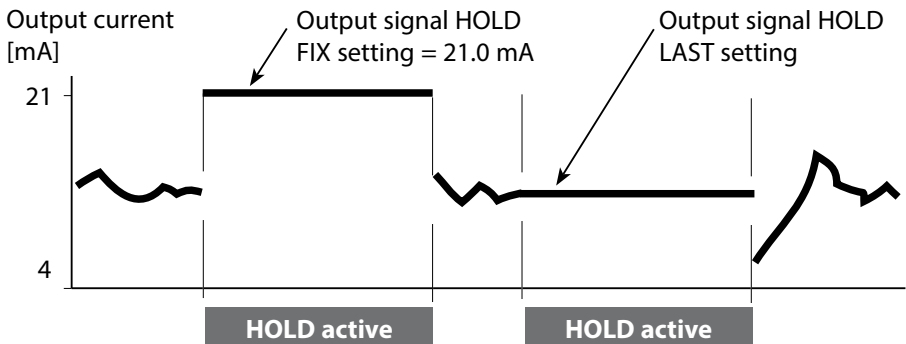

Configuration

Correction

Polarization voltage / Membrane temperature compensation / Process pressure / Salinity correction

1 **conf**

2



3

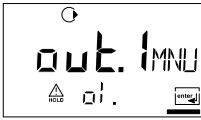

4



Correction

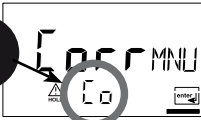





enter

Co.UPOL	Polarization voltage
Co.CAp	Membrane temperature compensation
Co.UnIT	Meas. unit (pressure)
Co.PrES	Process pressure
Co.SAL	Salinity correction

enter

4

5 **conf** **enter**

Code	Display	Action	Choices
Co.		Enter polarization voltage Select using ▶ key, edit number using ▲ key. Press enter to proceed.	0675 mV
		Membrane temperature compensation Select position using ▶ key and edit number using ▲ key. Press enter to proceed.	01.00
		Select pressure unit Select using ▶ key, press enter to proceed.	bar (kPa, PSi)
		Process pressure correction Enter process pressure. This value is used to correct the oxygen saturation. It has no influence on concentra- tion measurement (Conc). Select position using ▶ key and edit number using ▲ key. Press enter to proceed.	1.013 bar
		Enter salinity correction Select position using ▶ key and edit number using ▲ key. Press enter to proceed.	00.00 ppt* * ppt (parts per thousand) - corresponds to g/kg

Please note:

When using a sensor with a polarization voltage different from 675 mV (factory setting), you must enter the correct voltage before connecting the sensor!

Otherwise the sensor may be damaged!



Configuration

Calibration Mode

- 1 Press **conf** key.
- 2 Enter passcode **1200**.
- 3 Select **Calibration mode** menu group using arrow keys. All items of this menu group are indicated by the "CA." code.
- 4 Press **enter** to select menu, edit using arrow keys (see page 47). Confirm (and proceed) by pressing **enter**.
Exit: Press **conf**, then **enter**.

CA.MOD	Calibration mode
CA.tiME	Cal timer interval

5 **conf enter**

Code	Display	Action	Choices
CA.		Specify calibration mode (calibration to saturation or concentration) Select using ► key, press enter to proceed.	SAt (Conc)
		Cal timer interval The cal timer reminds you to calibrate in time. Select using ►, edit number using ▲ key. Press enter to proceed.	0000 h (0 ... 9999 h)

Please note:

When calibrating in air-saturated water (standard practice for biotechnological processes), you should select calibration to saturation (SAT).

If the sensor can be removed for calibration, however, we recommend the easier and more precise calibration in air. To do so, you have to set the calibration mode to Concentration (Conc), see also page 59.

Configuration

Alarm Settings

1 **conf**

2



3

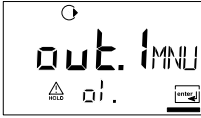

4



5



6



Alarm settings:

3

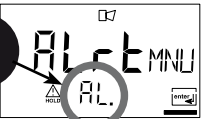

enter

4

AL.SnSO Select Sensocheck

5 **conf** **enter**

- 1 Press **conf** key.
- 2 Enter passcode **1200**.
- 3 Select **Alarm settings** menu group using arrow keys. All items of this menu group are indicated by the "AL." code.
- 4 Press **enter** to select menu, edit using arrow keys (see page 49). Confirm (and proceed) by pressing **enter**.
- 5 Exit: Press **conf**, then **enter**.

Code	Display	Action	Choices
AL.		Select Sensocheck (continuous monitoring of sensor) Select using ► key, press enter to proceed.	OFF (ON / OFF)

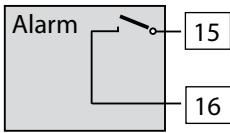

Alarm Contact

The alarm contact is closed during normal operation (N/C). It opens in the case of alarm or power outage. As a result, a failure message is provided even in the case of line breakage (fail-safe behavior).

For contact ratings, see Specifications.

Error messages can also be signaled by a 22 mA output current (see page 36, 42, 72).

The operating behavior of the alarm contact is shown on page 75.

The **alarm delay** acts on the LED, the 22 mA signal and the alarm contact.

Configuration

Limit Function Relay

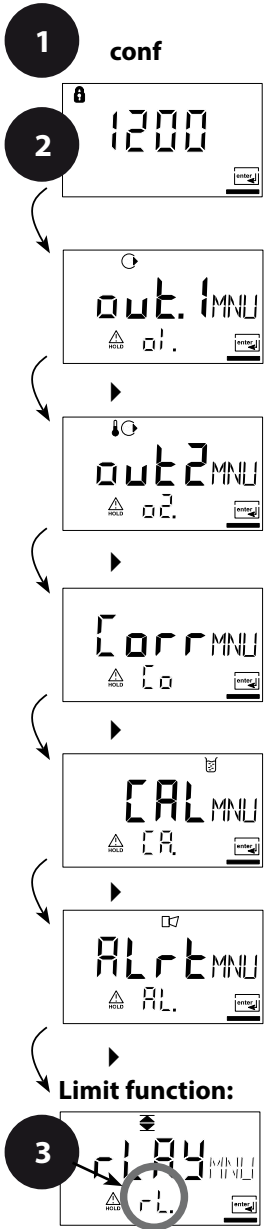

- 1 Press **conf** key.
- 2 Enter passcode **1200**.
- 3 Select **Limit function** menu group using arrow keys. All items of this menu group are indicated by the "L1." code.
- 4 Press **enter** to select menu, edit using arrow keys (see page 51). Confirm (and proceed) by pressing **enter**.
- 5 Exit: Press **conf**, then **enter**.

L1.FCT	Contact function	4
L1.tYP	Contact response	enter
L1.LEVL	Enter setpoint	enter
L1.HYS	Enter hysteresis	
L1.dLY	Delay	

5 conf enter

Code	Display	Action	Choices
L1.		Contact function (see below for function principle) Select using ▶ key, press enter to proceed.	Lo (Lo/Hi)
		Contact response N/C: normally closed contact N/O: normally open contact Select using ▶ key, press enter to proceed.	N/C (N/O N/C)
		Setpoint Select using ▶ key, edit number using ▲ key. Press enter to proceed.	000.0 % (xxx.x %)
		Hysteresis Select using ▶ key, edit number using ▲ key. Press enter to proceed.	001.0 % (xxx.x %)
		Delay The contact is activated with delay (deactivated without delay) Select using ▶ key, edit number using ▲ key. Press enter to proceed.	0010 sec (0 ... 600 sec)

Limit Lo

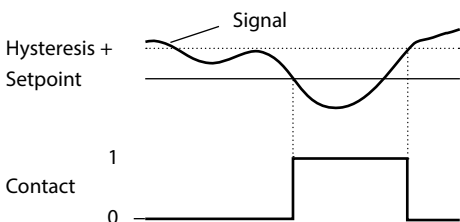

Limit Hi

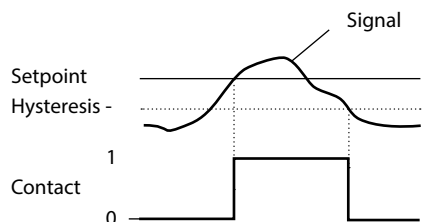

Controlling a Rinsing System “Clean” contact

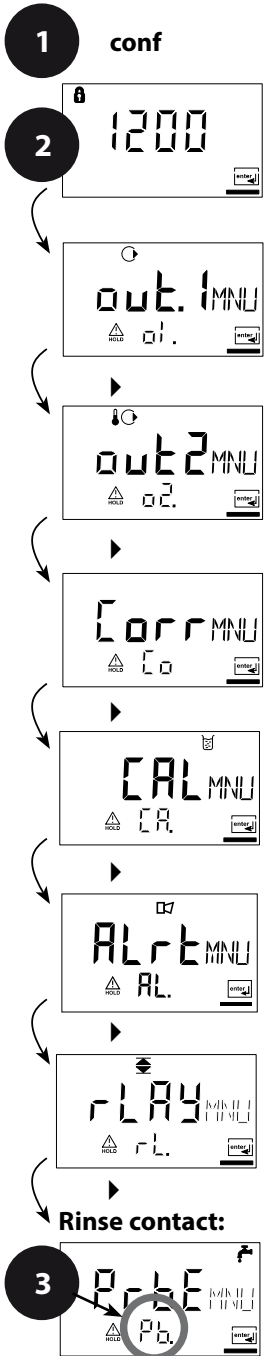



- 1 Press **conf** key.
- 2 Enter passcode **1200**.
- 3 Select **Rinsing probes** menu group using arrow keys. All items of this menu group are indicated by the “Pb.” code.
- 4 Press **enter** to select menu, edit using arrow keys (see next page). Confirm (and proceed) using **enter**.
- 5 Exit: Press **conf**, then **enter**.

4	Pb.InTV	Rinsing interval	enter ↶ ↷
	Pb.rins	Rinse duration	
	Pb.typ	Contact response	

enter

5 **conf** **enter**

Code	Display	Action	Choices
Pb.		Rinsing interval Select using ▶ key, enter number using ▲ , press enter to proceed.	0.000 h (x.xxx h)
		Rinse duration Select using ▶ key, enter number using ▲ , press enter to proceed.	0060 s (xxxx s)
		Contact response N/C: normally closed contact N/O: normally open contact Select using ▶ , press enter to proceed.	N/C (N/O)

Connecting a Rinsing System

The "Clean" contact can be used to connect a simple rinsing system. Rinse duration and rinsing interval are defined during configuration.

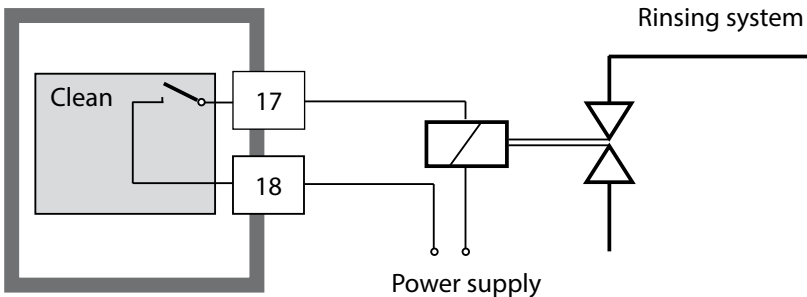

Parameters

Factory Settings of Parameters

Activation:

Simultaneously press **conf** + right arrow key and enter passcode "4321".

The lower display line reads "Clear". To prevent accidental resetting, "NO" is set as default (blinking in the main display). Press one of the arrow keys to select "YES" and confirm by pressing **enter**.

CAUTION!

Your data (also calibration data) will be overwritten by the factory settings!

Code	Parameter	Factory setting
o1.SnSR	Sensor type	A
o1.UnIT	%, mg/l, ppm	%
o1. rNG	0/4-20 mA	4-20 mA
o1. 4mA	Current start	0000 %
o1.20mA	Current end	0200 %
o1.FtME	Filter time	0 s
o1.FAIL	22mA signal	OFF
o1.HoLD	HOLD response	Last
o1.FIX	Fix current	021.0 mA
o2.UnIT	Unit °C / °F	°C
o2.rTD	Temp probe	22NTC
o2.rNG	0/4 ...20mA	4-20 mA
o2. 4mA	Current start	000.0 °C
o2.20mA	Current end	100.0 °C
o2.FtME	Filter time	0 s
o2.FAIL	22mA signal	OFF
o2.HoLD	HOLD response	Last
o2.FIX	Fix current	021.0 mA

Code	Parameter	Factory setting
Co.UPOL	Polarization voltage	675 mV
Co.CAP	Membrane temp. compensation	01.00
Co.UnIT	Pressure unit	bar
Co.PrES	Pressure	1.013 bar
Co.SAL	Salinity	00.00 ppt
Ca.MOD	Calibration mode	Sat
CA.tiME	Cal interval	0000 h
AL.SnSO	Sensocheck	OFF
L1.FCT	Contact function	Lo
L1.tYP	Contact response	N/C
L1.LEVL	Setpoint	0000 %
L1.HYS	Hysteresis	0001 %
L1.dLY	Delay	0010 sec
Pb.InTV	Rinsing interval	000.0 h
Pb.rins	Rinse duration	0060 s
Pb.typ	Contact type	N/C

Please note:

Fill in your configuration data on the following pages.

Please note:

Factory settings for the calibration data are 60.0 nA (slope) and 0.000 nA (zero).

Parameters

Parameters – Individual Settings

Code	Parameter	Setting
o1.SnSR	Sensor type	
o1.UnIT	%, mg/l, ppm	
o1. rNG	0/4-20 mA	
o1. 4mA	Current start	
o1.20mA	Current end	
o1.FtME	Filter time	
o1.FAIL	22mA signal	
o1.HoLD	HOLD response	
o1.FIX	Fix current	
o2.UnIT	Unit °C / °F	
o2.rTD	Temp probe	
o2.rNG	0/4 ... 20mA	
o2. 4mA	Current start	
o2.20mA	Current end	
o2.FtME	Filter time	
o2.FAIL	22mA signal	
o2.HoLD	HOLD response	

Code	Parameter	Setting
o2.FIX	Fix current	
Co.UPOL	Polarization voltage	
Co.CAp	Membrane temp. compensation	
Co.UnIT	Pressure unit	
Co.PrES	Pressure	
Co.SAL	Salinity	
Ca.MOD	Calibration mode	
CA.tiME	Cal interval	
AL.SnSO	Sensocheck	
L1.FCT	Contact function	
L1.tYP	Contact response	
L1.LEVL	Setpoint	
L1.HYS	Hysteresis	
L1.dLY	Delay	
Pb.InTV	Rinsing interval	
Pb.rins	Rinse duration	
Pb.typ	Contact type	

Calibration

Calibration adjusts the device to the sensor.

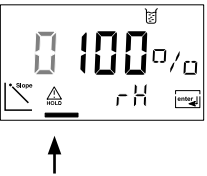
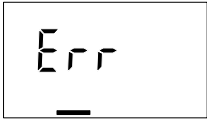
Activation	cal	Activate by pressing cal
		<p>Activate by pressing cal</p> <p>Enter passcode:</p> <ul style="list-style-type: none"> • Zero point 1001 • Water/Air 1100 <p>Edit parameter using ▶ and ▲. Confirm and proceed by pressing enter. (Exit by pressing cal, then enter.)</p>
<p>HOLD</p> <p>During configuration the device remains in the Hold mode.</p>	 <p>HOLD icon</p>	<p>During calibration the device remains in the Hold mode for reasons of safety. The output current is frozen (at its last value or at a preset fixed value, depending on the configuration), limit and alarm contacts are inactive. Sensoface is off, "Calibration" mode indicator is on.</p>
<p>Input errors</p>		<p>The calibration parameters are checked during the input. In the case of an incorrect input "Err" is displayed for approx. 3 sec. The incorrect parameters cannot be stored. Input must be repeated.</p>
<p>Exit</p>	<p>enter</p> <p>enter</p>	<p>Exit by pressing enter (abort using cal). The measured value and Hold are displayed alternately, "enter" blinks. Press enter to exit the Hold mode. The measured value is displayed. The output current remains frozen for another 20 sec (HOLD icon on, "hourglass" blinks).</p>

Information on Calibration

It is always recommended to calibrate in air.

Compared to water, air is a calibration medium which is easy to handle, stable, and thus safe. In the most cases, however, the sensor must be dismantled for a calibration in air. When dealing with biotechnological processes which require sterile conditions, the sensor cannot be removed for calibration. Here, calibration must be performed with aeration directly in the process medium (e.g. after sterilization). In the field of biotechnology, for example, often saturation is measured and calibration is performed in the medium for reasons of sterility. For other applications where concentration is measured (water control etc.), calibration in air has proved to be useful.

Common Combination:

Process Variable / Calibration Mode / Calibration Medium

Process variable	Cal mode	Calibration	Default rel. humidity	Default cal pressure
Saturation (%)	SAT	Water	100 %	Process pressure
Concentration (mg/l, ppm)	Conc	Air	50 %	1.013 bar

The calibration procedures for these two common applications are described on the following pages. Of course, other combinations of process variable and calibration mode are possible.





Please note:



When a 2-point calibration is required, the zero calibration should be performed prior to saturation or concentration calibration, resp. All calibration procedures must be performed by trained personnel.

See page 30 for setting the process variable.

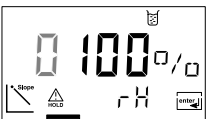
See page 46 for setting the calibration mode.

Calibration to Percent Saturation (SAT), in Water

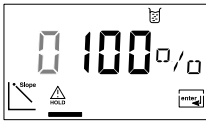



Display	Action	Remark
	<p>Press cal key, enter code 1100. Select using ▶ key, edit number using ▲ key. Press enter to proceed.</p>	<p>SAT or Conc calibration is selected during configuration. Device switches to Hold mode. If an invalid code is entered, the device returns to measuring mode.</p>
	<p>Immerse sensor in cal medium Start by pressing enter.</p>	
	<p>Enter relative humidity Select using ▶ , enter number using ▲ . Press enter to confirm entry.</p>	<p>Default for relative humidity in aqueous media: rH = 100 %</p>
	<p>Enter calibration pressure Select using ▶ , enter number using ▲ . Press enter to confirm entry.</p>	<p>Default for calibration pressure is the process pressure configured</p>
	<p>Automatic drift check Display of sensor current (related to 25 °C and 1013 mbars normal pressure) and measuring temperature.</p> <p>If the sensor does not stabilize within 12 minutes, calibration will be aborted.</p>	<p>Drift check can be stopped after > 10 sec by pressing cal (accuracy reduced).</p>



Display	Action	Remark
	<p>Enter setpoint value for saturation Select using ▶ key, edit number using ▲ key. Press enter to proceed.</p>	<p>Default: last value entered</p>
	<p>Display of new calibration values (related to 25°C at 1013 mbars). The zero point remains unchanged, for zero calibration see page 67. Exit calibration by pressing enter.</p>	<p>New calibration: Press cal key.</p>
	<p>Place sensor in process. The percent saturation is shown in the main display alternately with "Hold"; "enter" blinks. Exit by pressing enter.</p>	<p>After end of calibration, the outputs remain in Hold mode for approx. 20 sec.</p>

Information on Saturation Calibration (SAT) in Water

- The calibration medium should be water which is in equilibrium with the ambient air (percent saturation 100%). Oxygen exchange between water and air is very slow, however.
- If the calibration medium is not in equilibrium with air and the percent saturation is known from a simultaneous measurement, it can be entered manually.
- For 2-point calibration, perform zero calibration first!

Calibration to Concentration (Conc), in Air

Display	Action	Remark
	<p>Press cal key, enter code 1100. Press ▶ key to select position, enter number using ▲ key. Press enter to proceed.</p>	<p>SAT or Conc calibration is selected during configuration. Device switches to Hold mode. If an invalid code is entered, the device returns to measuring mode.</p>
	<p>Place sensor in air Press enter to start.</p>	
	<p>Enter relative humidity Press ▶ key to select position, enter number using ▲ key. Press enter to proceed.</p>	<p>Default for relative humidity in air: rH = 50 %</p>
	<p>Enter calibration pressure Press ▶ key to select position, enter number using ▲ key. Press enter to proceed.</p>	<p>Default for calibration pressure is normal pressure 1.013 bars.</p>
	<p>Automatic drift check Display of input current (related to 25 °C and 1013 mbars) and measuring temperature.</p> <p>If the sensor does not stabilize within 12 minutes, calibration will be aborted.</p>	<p>Drift check can be stopped after > 10 sec by pressing cal (accuracy reduced).</p>

Display	Action	Remark
	Enter default for concentration Press ▶ key to select position, enter number using ▲ key. Press enter to proceed.	Default value is calculated from rel. humidity, cal pressure, and cal temperature (the unit of measurement, ppm or mg/l, is preset during configuration).
	Display of new slope and zero point (related to 25 °C at 1013 mbars) Exit calibration by pressing enter .	New calibration: Press cal key.
	Place sensor in process. The new value for concentration is shown in the main display alternately with "Hold"; "enter" blinks. Exit by pressing enter .	After end of calibration, the outputs remain in Hold mode for approx. 20 sec.





Information on Concentration Calibration (Conc):

Calibration in air. This calibration method is recommended when the sensor can be removed for calibration. Air has a stable oxygen content. Therefore the adjustment processes during calibration run more quickly.

- For 2-point calibration, perform zero calibration first.

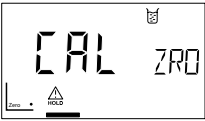
Zero Calibration

The sensor models SE 703 and SE 706 have a low zero current. Therefore, you should not perform a zero calibration with Stratos Eco 2405. If you still wish to perform a zero calibration, the sensor should remain for at least 10 to 30 minutes in an **oxygen-free** calibration medium in order to obtain stable, non-drifting values. During zero calibration, a drift check is not performed. Zero current of a properly functioning sensor is notably less than 0.5 % of air current. The display (secondary: measured value, main: entered value) does not change until an input current is entered for the zero point, see page 65. When measuring in an oxygen-free medium, the displayed current can be taken directly.



Display	Action	Remark
	<p>Select calibration (press cal key).</p> <p>Enter passcode 1001. Select using ▶ key, edit number using ▲ key. Press enter to proceed.</p>	<p>Device is in the Hold mode. If an invalid code is entered, the device returns to measuring mode.</p>
	<p>Place sensor in oxygen-free medium. Press enter to proceed.</p>	
	<p>Main display: Zero current. Press enter to save this value or correct using arrow keys and then save by pressing enter. Secondary display: Sensor current measured Press enter to proceed.</p>	
	<p>Display of slope Display of new zero current Exit calibration by pressing enter key, re-place sensor in process.</p>	<p>New calibration: Press cal.</p>
	<p>The oxygen value is shown in the main display alternately with "Hold", "enter" blinks. Stop Hold by pressing enter.</p>	<p>After end of calibration, the outputs remain in Hold mode for approx. 20 sec.</p>





Calibration

Product Calibration Calibration by comparison



During product calibration the sensor remains in the process.
The measurement is only interrupted briefly.

Procedure: The currently measured value is stored in the device for comparison. The comparison value is measured on the site, e.g. using a portable DO meter in a bypass. This value is then entered in the device. The new value for slope or zero is calculated from the stored value and the comparison value. From the measured value, the device automatically recognizes whether a new slope or zero must be calculated (above approx. 5 % saturation: slope, below: zero). The following describes a product calibration with slope correction – a product calibration with zero correction is performed correspondingly.

Display	Action	Remark
	Press cal key, enter code 1105. Press ▶ key to select position, enter number using ▲ key, confirm by pressing enter .	The type of product calibration (SAT or Conc) is selected during configuration (process variable). If an invalid code is entered, the device returns to measuring mode.
		Display (approx. 3 sec)

Display	Action	Remark
	Save currently measured value. Press enter to proceed.	Perform reference measurement.
	Enter the reference value. Confirm by pressing enter .	Calculation of new slope
	Display of new slope or new zero (related to 25 °C and 1013 mbars). Exit calibration by pressing enter .	New calibration: Press cal .
	The new measured value is shown in the main display alternately with "Hold", "enter" blinks. Exit by pressing enter .	After end of calibration, the outputs remain in Hold mode for approx. 20 sec.



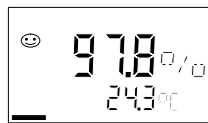

Temp Probe Adjustment

Display	Action	Remark
	<p>Select calibration Press cal key, enter code 1015. Press ▶ key to select position, enter number using ▲ key, confirm by pressing enter.</p>	<p>Wrong settings change the measurement properties! If an invalid code is entered, the device returns to measuring mode.</p>
	<p>Ready for calibration Measure the temperature of the process medium using an external thermometer.</p>	<p>Device is in Hold mode. Display approx. 3 sec</p>
	<p>Enter measured temperature value. Select using ▶ key, edit number using ▲ key. Press enter to proceed. Press enter to exit adjustment. HOLD will be deactivated after 20 sec.</p>	<p>The default value is shown in the main display, the currently measured value in the secondary display.</p>





Measurement

Display	Action
	<p>In the measuring mode the main display shows the configured process variable (% , mg/l, or ppm) and the lower display the temperature. During calibration you can return to measuring mode by pressing the cal key, during configuration by pressing conf (waiting time for signal stabilization approx. 20 sec).</p>

Diagnostics Functions

Display	Action
	Display of output currents Press enter while in measuring mode. The current at output 1 is shown in the main display, the current at output 2 in the secondary display. After 5 sec the device returns to measuring mode.
	Display of calibration data (Cal Info) Press cal while in measuring mode and enter code 0000. The slope is shown in the main display, the zero point in the secondary display. After 20 sec the device returns to measuring mode (immediate return at pressing enter).
	Sensor monitor (display of sensor current) Press conf while in measuring mode and enter code 2222. The sensor current (without temperature compensation) is shown in the main display, the measuring temperature in the secondary display. Press enter to return to measurement.
	Display of last error message (Error Info) Press conf while in measuring mode and enter code 0000. The last error message is displayed for approx. 20 sec. After that the message will be deleted (immediate return to measurement at pressing enter).















These functions are used for testing the connected peripherals.

Display	Action
	<p>Specify current for output 1 Press conf while in measuring mode and enter code 5555. The main display indicates the current provided by output 1. This value can be edited. To do so, select the position using ▶ key, edit number using ▲ key. Confirm entry by pressing enter. The entered value will be shown in the secondary display. The device is in Hold mode. The specified current is output. Press conf, then enter to return to measurement (Hold remains active for another 20 sec).</p>
	<p>Specify current for output 2 Press conf while in measuring mode and enter code 5556. The main display indicates the current provided by output 2. This value can be edited. To do so, select the position using ▶ key, edit number using ▲ key. Confirm entry by pressing enter. The entered value will be shown in the secondary display. The device is in Hold mode. The specified current is output. Press conf, then enter to return to measurement (Hold remains active for another 20 sec).</p>
	



Error Messages (Error Codes)

Error	Display	Problem Possible causes	Alarm contact	Red LED	Out 1 (22 mA)	Out 2 (22 mA)
ERR 01	Measured value blinks	SAT range <ul style="list-style-type: none"> • Sensor defective • Wrong sensor connected • Measurement range exceeded 	x	x	x	
ERR 02	Measured value blinks	Conc range <ul style="list-style-type: none"> • Sensor defective • Wrong sensor connected • Measurement range exceeded 	x	x	x	
ERR 98	“Conf” blinks	System error Configuration or calibration data defective; completely reconfigure the device using the factory settings. Then calibrate. Memory error in device program	x	x	x	x
ERR 99	“FAIL” blinks	Factory settings EEPROM or RAM defective This error message only occurs in the case of a total defect. The device must be repaired and recalibrated at the factory.	x	x	x	x































Error Messages (Error Codes)

Error	Icon (blinks)	Problem Possible causes	Alarm contact	Red LED	Out 1 (22 mA)	Out 2 (22 mA)
ERR 03		Temperature probe Open or short circuit Temperature range exceeded	x	x	x	x
ERR 11		Current output 1 Current below 0 (3.8) mA	x	x	x	
ERR 12		Current output 1 Current above 20.5 mA	x	x	x	
ERR 13		Current output 1 Current span too small / too large	x	x	x	
ERR 21	 	Current output 2 Current below 0 (3.8) mA	x	x		x
ERR 22	 	Current output 2 Current above 20.5 mA	x	x		x
ERR 23	 	Current output 2 Current span too small / too large	x	x		x
ERR 33		Sensocheck: Sensor: Connecting cable defective	x	x	x	
		• Zero error, Sensoface active, see page 77				
		• Slope error, Sensoface active, see page 77				
		• Response time exceeded, Sensoface active, see page 77				
		• Calibration interval expired, Sensoface active, see page 77				

Calibration Error Messages

Icon blinks:	Problem Possible causes
	Slope out of range Wrong calibration values specified (relative humidity, pressure, saturation, concentration)
 In addition "CAL Err" blinks.	Calibration aborted after 12 minutes Sensor defective or dirty <ul style="list-style-type: none">• No electrolyte in the sensor• Sensor cable insufficiently shielded or defective• Strong electric fields influence the measurement• Temperature fluctuation of calibration solution

Operating States

Operating status	Out 1	Out 2	Relay 1 limit value	Alarm contact	Cleaning contact	Timeout
Measure						
Cal Info (cal) 0000						20 s
Error Info (conf) 0000						20 s
Calibration (cal) 1100						
Temp adjustment (cal) 1015						
Product calibration (cal) 1105						
Configuration (conf) 1200						20 min
Sensor monitor (conf) 2222						20 min
Current source 1 (conf) 5555						20 min
Current source 2 (conf) 5556						20 min
Rinsing function						

 active











 as configured (Last/Fix or Last/Off)

(Sensochek must have been activated during configuration.)

The smiley in the display (Sensoface) alerts to sensor problems (defective cable, maintenance request). The permitted calibration ranges and the conditions for a friendly, neutral or sad Sensoface are summarized in the following chart. Additional icons refer to the error cause.

Replace membrane module or filling solution, if required.













Type A Sensors (SE 703, SE 706)

	Slope	Zero point	Response time	Cal timer
Permitted range	25 ... 130 nA	-2 ... +2 nA	max. 720 s	
	> 35 ... < 90 nA	> -0.3 ... < 0.3 nA	≤ 300 s	≤ 80 %
	 30 ... 35 nA or 90 ... 110 nA	 -0.6 ... -0.3 nA or +0.3 ... +0.6 nA	 300 ... 600 s	 80 ... 100 %
	 < 30 nA or > 110 nA	 < -0.6 nA or > +0.6 nA	 > 600 s	 Timer expired

Notice

The worsening of a Sensoface criterion leads to the devaluation of the Sensoface indicator (Smiley becomes "sad"). To reset the Sensoface indicator, the defect must be remedied.

Type B Sensors (Sensors with Higher Current)

	Slope	Zero point	Response time	Cal timer
Permitted range	200 ... 550 nA	-2 ... +2 nA	max. 720 s	
	> 250 ... < 500 nA	> -0.5 ... < 0.5 nA	< 300 s	< 80 %
	 225 ... 250 nA or 500 ... 525 nA	 -1.0 ... -0.5 nA or +0.5 ... +1.0 nA	 300 ... 600 s	 80 ... ≤ 100 %
	 < 225 nA or > 525 nA	 < -1.0 nA or > +1.0 nA	 > 600 s	 Timer expired
 	Thermometer and Sensoface: Temperature out of concentration or saturation range			

Sensocheck

Continuously monitors the sensor and leads for short circuits or open circuits. Critical values make the Sensoface “sad” and the corresponding icon blinks:



The Sensocheck message is also output as error message Err 33. The alarm contact is active, the red LED is lit, output current 1 is set to 22 mA (when configured correspondingly). Sensocheck can be switched off during configuration (then Sensoface is also disabled).
Exception: After a calibration a smiley is always displayed for confirmation.

Product Line and Accessories

Devices

Stratos Eco 2405 Oxy

Order No.

2405 Oxy

Mounting Accessories

Pipe-mount kit

ZU 0274

Panel-mount kit

ZU 0275

Protective hood

ZU 0276

For more information concerning our sensors and fittings product line,
please refer to our website:
www.knick.de

Specifications

DO input

Measuring current	-2 ... +1800 nA
Resolution (with $V_{\text{pol}} \leq 800$ mV and $V_{\text{ref}} \leq 200$ mV)	0.05 nA
Saturation (-10 ... 80 °C)	0... 200%
Meas. error ^{1,2,3)}	0.5 % meas.val. + 0.5 %
Concentration (-10 ... 80 °C)	0,00 ... 20.00 mg/l 0.00 ... 20.00 ppm
Meas. error ^{1,2,3)}	0.5 % meas.val. + 0.05 mg/l or 0.05 ppm
Permitted guard current	≤ 20 μ A
Polarization voltage *	0 ... 1000 mV
Factor for membrane temp. compensation *	00.50 ... 03.00
Process pressure *	0.000 ... 9.999 bars (... 999.9 kPa / ... 145.0 psi)
Salinity correction *	00.00 ... 45.00 g/kg

Sensor standardization

Operating modes *

- O₂ saturation (automatic)
- O₂ concentration (automatic)
- Product calibration
- Zero calibration

Calibration range Sensor Type A	Zero point	± 2 nA
	Slope	25 ... 130 nA (at 25 °C, 1013 mbars)
Calibration range Sensor Type B	Zero point	± 2 nA
	Slope	200 ... 550 nA (at 25 °C, 1013 mbars)
Calibration timer *	0000 ... 9999 h	
Pressure correction *	0.000 ... 9.999 bars / 999.9 kPa / 145.0 psi	

Sensor monitoring

Sensocheck	Monitoring for short circuits / open circuits (can be disabled)
Sensoface	Provides information on the sensor condition (evaluation of zero/slope, response time, calibration interval, Sensocheck)

Temperature input *

	NTC 22 k Ω / NTC 30 k Ω 2-wire connection, adjustable
Measuring range	-20.0 ... +150.0 °C / -4 ... +302 °F
Adjustment range	10 K
Resolution	0.1 °C / 1 °F
Meas. error ^{1,2,3)}	< 0.5 K (< 1 K at > 100°C)

Output 1

	0/4 ... 20 mA, max. 10 V, floating (galvanically connected to output 2)
Process variable*	DO saturation/DO concentration
Overrange *	22 mA in the case of error messages
Output filter *	Low-pass, filter time constant 0 ... 120 s
Measurement error ¹⁾	< 0.3% current value + 0.05 mA
Start/end of scale	As desired within range
Permissible span	5 ... 200 % / 0.5 ... 20 mg/l (ppm)

Output 2

	0/4 ... 20 mA, max. 10 V, floating (galvanically connected to output 1)
Process variable	Temperature
Overrange *	22 mA in case of temp error messages
Output filter *	Low-pass, filter time constant 0 ... 120 s
Measurement error ¹⁾	< 0.3% current value + 0.05 mA
Start/end of scale *	-20 ... +150 °C / -4 ... +302 °F
Permissible span	20 ... 170 K / 36 ... 306 °F

Specifications

Alarm contact	Relay contact, floating
Contact ratings	AC < 250 V / < 3 A / < 750 VA DC < 30 V / < 3 A / < 90 W
Contact response	N/C (fail-safe type)
Response delay	10 s
Limit value	Output via relay contact
Contact ratings	AC < 250 V / < 3 A / < 750 VA DC < 30 V / < 3 A / < 90 W
Contact response*	N/C or N/O
Delay*	0000 ... 9999 s
Setpoint*	Within selected range
Hysteresis*	000.0 ... 050.0 % / 00.00 ... 05.00 mg/l (ppm)
Rinsing function	Relay contact, floating, for controlling a simple rinsing system
Contact ratings	AC < 250 V / < 3 A / < 750 VA DC < 30 V / < 3 A / < 90 W
Contact response	N/C or N/O
Rinse interval	000.0 ... 999.9 h (000.0 h = rinsing function switched off)
Rinse duration	0000 ... 1999 s
Display	LC display, 7-segment with icons
Main display	Character height 17 mm, unit symbols 10 mm
Secondary display	Character height 10 mm, unit symbols 7 mm
Sensoface	3 status indicators (friendly, neutral, sad face)
Mode indication	4 mode indicators "meas", "cal", "alarm", "config" Further icons for configuration and messages
Alarm indication	Red LED in case of alarm
Keypad	5 keys: [cal] [conf] [▶] [▲] [enter]

Service functions

Current source	Current specifiable for output 1 and 2 (00.00 ... 22.00 mA)
Device self-test	Automatic memory test (RAM, FLASH, EEPROM)
Display test	Display of all segments
Last Error	Display of last error occurred
Sensor monitor	Display of direct, uncorrected sensor signal

Data retention

Parameters and calibration data > 10 years (EEPROM)

Protection against electric shock

Protective separation of all extra-low-voltage circuits against mains by double insulation to EN 61010-1

Power supply

24 (-15%) ... 230 V AC/DC (+10%); approx. 5 VA, 2.5 W
AC: 45 ... 65 Hz
Overvoltage category II, protection class II

Nominal operating conditions

Ambient temperature	-20 ... +55 °C / -4 ... +131 °F
Transport/Storage temp	-20 ... +70 °C / -4 ... +158 °F
Relative humidity	10...95 % not condensing, maximum operating height 2000 m
Power supply	24 (-15%) ... 230 V AC/DC (+10%)
Frequency for AC	45 ... 65 Hz

EMC

Emitted interference	EN 61326-1, EN 61326-2-3 Class B (residential area) Class A for mains > 60 V DC
Immunity to interference	Industry

Explosion protection

FM	NI Class I Div 2 Group A, B, C & D, T4 Ta = 55 °C; Type 2 NI Class I Zone 2 Group IIC, T4 Ta = 55°C; Type 2
----	---

Specifications

Enclosure	Molded enclosure made of PBT, glass bead reinforced
Color	Black
Mounting	<ul style="list-style-type: none">• Wall mounting• Pipe mounting: Ø 40 ... 60 mm □ 30 ... 45 mm• Panel mounting, cutout to DIN 43 700, sealed against panel
Dimensions	H 144 mm, W 144 mm, D 105 mm
Ingress protection	IP 65 / NEMA 4X
Cable glands	3 knockouts for cable glands M20x1.5 2 knockouts for NPT 1/2" or rigid metallic conduit
Weight	Approx.1 kg

* User-defined

- 1) To IEC 746 Part 1, at nominal operating conditions
- 2) ± 1 count
- 3) Plus sensor error

Warnings and Notes to Ensure Safe Operation

WARNING!

Do not disconnect equipment unless power has been switched off.

CAUTION!

Clean only with antistatic moistened cloth.

CAUTION!

Substitution of components may impair suitability for hazardous locations.

- The equipment shall be installed and protected from mechanical impact and ultraviolet (UV) sources.
- Clean only with a moistened antistatic cloth as potential electrostatic hazard may exist. Service equipment only with conductive clothing, footwear and personal grounding devices to prevent electrostatic accumulation.
- Internal grounding provisions shall be provided for field wiring. Bonding between conduit shall be provided during installation, and all exposed non-current carrying metallic parts shall be bonded and grounded.
- The equipment shall have a switch or circuit breaker in the building installation (that is in close proximity to the equipment) that is marked as the disconnect switch.
- The enclosure Type 2 is only for indoor use.
- The mains supply voltage fluctuations should not exceed -15/+10 percent of the nominal supply voltage.
- The device shall not be used in a manner not specified by this manual.

Safe Operation

CAUTION!

Use supply wires suitable for 30 °C / 86 °F above ambient and rated at least 250 V.

CAUTION!

Use signal wires suitable for at least 250V.

22 mA signal for error message 37, 43

A

Accessories 81

Alarm contact 49

Alarm settings 25, 48

Approvals 87

Assembly 10

C

Calibration 58

 Calibration mode selection 46

 Calibration to concentration (Conc) 62

 Calibration to percent saturation (SAT) 60

 Cal timer interval 46

 Error messages 74

 Product calibration 66

 Zero calibration 64

Cal Info 70

“Clean” contact 52

Concentration calibration 62

Configuration 26

 Menu structure 27

Configuration: Alarm settings 48

Configuration: Calibration mode 46

Configuration: Correction 44

Configuration: Limit function 50, 52

Configuration: Output 1 30

 Output current during Error and HOLD 36

 Output current range 32

 Process variable 30

 Sensor type 30

 Time constant of output filter 34

Configuration: Output 2 38

 Output current 38

 Output current during HOLD 42

- Temperature 38
- Temperature error 42
- Time constant of output filter 40
- Configuration: Rinsing probes 52
- Connection 14
- Current start / end 33, 39

D

- Device self-test 23
- Diagnostics functions 70
 - Display of calibration data 70
 - Display of last error message 70
 - Display of output currents 70
 - Display of sensor current 70
 - Specifying the output current 71
- Display 21
- Disposal 2
- Division 2 wiring 15
- Documentation 8

E

- Error Info 70
- Error messages 72
 - Display of last error message 70
- Explosion protection 85

F

- Factory settings of parameters 54
- Front panel 20

H

- HOLD mode 24
 - Output signal during HOLD 37, 43
- Hysteresis 51

I

Installation 14
Intended use 7

K

Keypad 22

M

Measurement 69
Mounting plan 11

O

Operating states 75
Output filter 34, 40
Overview 9
Overview of configuration steps 28

P

Package contents 10
Panel mounting 13
Panel-mount kit 13
Parameters
 Factory settings 54
 Individual settings 56
Passcodes 93
Pipe mounting 12
Pipe-mount kit 12
Polarization voltage 45
Pressure correction 45
Product calibration 66
Product line 81
Protective hood 12
Protective wiring 18

Q

Quickstart guides 8

R

Relay 50, 52
Relay contacts 18
Rinse contact 52
Rinsing interval 53
Rinsing probes 52
Rinsing system 53

S

Safe Operation 87
Safety information 5, 87
Salinity correction 45
Self-test 23
Sensocheck 23, 48, 79
 Configuration 49
Sensoface 23, 77, 79
Sensor connection 17
Sensor monitor 70
Short instructions 8
Specifications 82

T

Temperature measurement, configuration 39
Temperature probe adjustment 69
Terminal assignments 14
Time constant of output filter 35, 41
Trademarks 7

U

User interface 20

W

Wiring example 17

Z

Zero calibration 64

Calibration

Key + passcode	Menu item	Page
cal + 0000	CAL info (display of zero,slope)	70
cal + 1001	Zero calibration	64
cal + 1100	Calibration (water / air)	60
cal + 1105	Product calibration	66
cal + 1015	Temp probe adjustment	69

Configuration

Key + passcode	Menu item	Page
conf + 0000	Error info (display of last error, erase)	70
conf + 1200	Configuration	26
conf + 2222	Sensor monitor (sensor current)	70
conf + 5555	Current source 1 (specify output current)	71
conf + 5556	Current source 2 (specify output current)	71
conf +  4321	Factory setting	54



Knick
Elektronische Messgeräte
GmbH & Co. KG

Headquarters

Beuckestraße 22 • 14163 Berlin

Germany

Phone: +49 30 80191-0

Fax: +49 30 80191-200

info@knick.de

www.knick.de

Local Contacts

www.knick-international.com

Copyright 2020 • Subject to change

This document was last updated on Nov. 16, 2020

The latest documents are available for download on our website
under the corresponding product description.



097808

TA-194.433-KNEN06

Software version: 2.x