

**Betriebsanleitung
Deutsch**

**User Manual
English**

**Manuel utilisateur
français**

VariTrans P2900*P2

Hochspannungs-Trennverstärker

High Voltage Transducers

Convertisseurs haute tension

Vor Installation lesen.

Für künftige Verwendung
aufbewahren.

Read before installation.

Keep for future use.

Lire avant l'installation.

Conserver pour une utilisation
ultérieure.

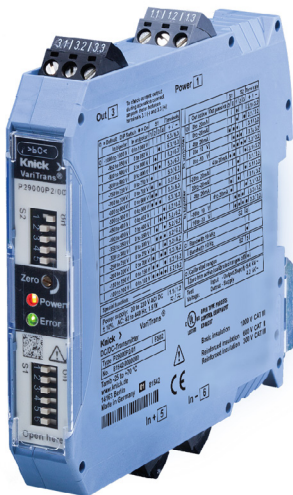

Inhaltsverzeichnis

Sicherheit	4
Symbole und Kennzeichen	5
Abkürzungen und Bezeichnungen	6
Bestimmungsgemäßer Gebrauch	7
Prinzipschaltbild	8
Typschilder	9
Funktion	11
Bedienelemente (Kopfplatte)	12
Eingangsbereiche	13
Ausgangsbereiche	15
Montage und elektrischer Anschluss	16
Klemmenbelegung und Abmessungen	17
Beschaltungsvarianten Eingang	18
Beschaltungsvarianten Ausgang	19
Prüfbuchsen	21
Kennlinienverläufe	22
Technische Daten	24
Wartung, Fehlersuche, Entsorgung	30
Lieferprogramm	32
Zubehör	33

Sicherheit

▲ WARNUNG! Berührungsgefährliche Spannungen.

Bei Anwendungen mit hohen Arbeitsspannungen ist genügend Abstand bzw. Isolation zu Nebengeräten und Berührungsschutz einzuhalten.

Anforderungen an das Personal

Installation, Inbetriebnahme, Betrieb, Instandhaltung und Außerbetriebnahme des Produkts dürfen ausschließlich durch vom Betreiber autorisiertes, im Umgang mit dem Produkt unterwiesenes Fachpersonal ausgeführt werden. Abhängig vom Einsatzgebiet des Produkts hat der Betreiber nach den gültigen lokalen und nationalen Vorschriften eine ausreichende Qualifikation des Personals sicherzustellen.

Zu Ihrer Sicherheit:

- Diese Betriebsanleitung über den Nutzungszeitraum des Produkts aufbewahren.
- Die Sicherheitshinweise in dieser Betriebsanleitung und auf dem Hochspannungstrennverstärker einhalten.
- Zwischen Trennverstärker und Netz eine zweipolige Trennvorrichtung einrichten.
- Erst nach Abschluss der fachgerechten Installation und Parametrierung den Hochspannungstrennverstärker mit Hilfsenergie versorgen.
- Während des Betriebs keine Bereichsumschaltung vornehmen.

Elektrostatische Entladung

Schutz gegen elektrostatische Entladung (ESD) sicherstellen.

Symbole und Kennzeichen

Erläuterungen der Symbole und Kennzeichen auf dem Gehäuse des Hochspannungstrennverstärkers oder in der Betriebsanleitung:

Symbol	Bedeutung
--------	-----------



Warnung vor gefährlicher elektrischer Spannung bei Berührung elektrischer Bauteile!



Lesen Sie die Betriebsanleitung, beachten Sie die technischen Daten und befolgen Sie die Sicherheitshinweise!



WARNUNG! Kennzeichnet eine Situation, die zum Tod oder zu schweren Verletzungen (irreversibel) führen kann. Informationen zur Vermeidung werden angegeben.

Kennzeichen

Symbol	Bedeutung
--------	-----------



CE-Kennzeichen



UL-Kennzeichen

▲ WARNUNG! Berührungsgefährliche Spannungen.

Anwendungen mit einer Arbeitsspannung eines der Kreise oberhalb der spezifizierten verstärkten Isolierung (siehe Seiten 9 und 27) und möglichem Kontakt einer Person zu einem anderen Kreis erfordern eine weitere Schutzmaßnahme entsprechend den jeweiligen Vorschriften für die Errichtung von elektrischen Anlagen (z. B. VDE 0100 und NEC), wie z. B.:

- zusätzliche Isolierung
- Schutzverbindung oder Schirmung
- selbsttätige Trennung von der Stromversorgung
- Strom- oder Spannungsbegrenzungseinrichtung

Abkürzungen und Bezeichnungen

	Bedeutung
Error	Fehlerzustand
Power	Hilfsenergie
Zero	Justage Nullpunkt des Potentiometers
S1	Schalter 1
S2	Schalter 2
HV	Hochspannung (<i>High Voltage</i>)
P2900*	P2900* ist der Oberbegriff der Produktlinie.

Bestimmungsgemäßer Gebrauch

Der Hochspannungstrennverstärker misst Spannungen in verschiedenen, umschaltbaren Messbereichen. Er dient zur Messung von Spannungen und von Strömen via Shunt-Widerstand. Die Umschaltung der Messbereiche erfolgt kalibriert über DIP-Schalter. Das jeweilige Eingangssignal wird am Ausgang als Normsignal 0/4 ... 20 mA bzw. 0 ... 10 V oder als bipolares Ausgangssignal -20 ... 20 mA bzw. -10 ... 10 V abgebildet. Der Nullpunkt kann über ein zuschaltbares Potentiometer angepasst werden.

Das Gerät besitzt eine galvanische 3-Port-Trennung zwischen Eingang, Ausgang und Hilfsenergie.

Bis zu 192 Signalkombinationen in einem Gerät sind möglich.

Typische Einsatzgebiete:

- Wechselrichter, Gleichrichter und Frequenzumrichter
- Elektrische Antriebe und Generatoren
- Stromversorgung für Schweißanlagen
- Solar- und Windkraftanlagen
- Elektrische Energiespeicher
- Überwachung von Ladevorgängen und Zuständen
- Überwachung und Steuerung von DC Stromversorgungseinrichtungen

Prinzipschaltbild

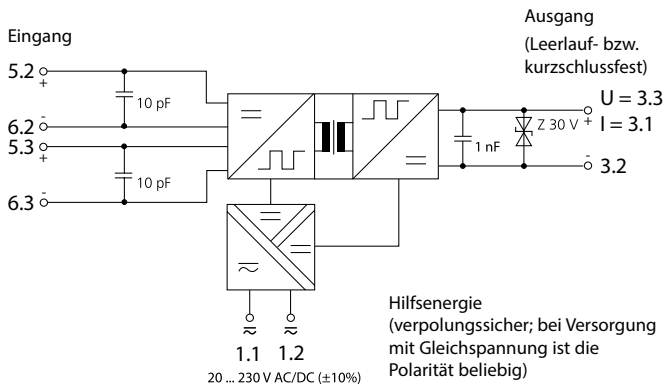

Typschilder

Produktvarianten

24 V DC

O	Default	DIP Switch	On	S1	Terminals		
	In bipolar	In unipolar	1	2	3	4	+ / -
O	+1000 to 1000 V	0 to 1000 V		•	5	3	6 / 3
	-950 to 950 V	0 to 950 V		•	5	3	6 / 3
	-900 to 900 V	0 to 900 V		•	5	3	6 / 3
	-800 to 800 V	0 to 800 V		•	5	3	6 / 3
	-750 to 750 V	0 to 750 V		•	5	3	6 / 3
	-700 to 700 V	0 to 700 V		•	5	3	6 / 3
	-600 to 600 V	0 to 600 V		•	5	3	6 / 3
	-500 to 500 V	0 to 500 V		•	5	3	6 / 3
	-450 to 450 V	0 to 450 V		•	5	2	6 / 2
	-400 to 400 V	0 to 400 V		•	5	2	6 / 2
	-350 to 350 V	0 to 350 V		•	5	2	6 / 2
	-300 to 300 V	0 to 300 V		•	5	2	6 / 2
	-250 to 250 V	0 to 250 V		•	5	2	6 / 2
	-200 to 200 V	0 to 200 V		•	5	2	6 / 2
	-150 to 150 V	0 to 150 V		•	5	2	6 / 2
	-100 to 100 V	0 to 100 V		•	5	2	6 / 2

Special function: _____

Power supply: 24 V DC \pm 25%, 1.5 W | 1.1 / 1.2 \pm / \pm

Knick >

VariTrans®

DC/DC-Transmitter

Type P29000P2/00 | ES02

No. 80434/0000000

Tamb -25 to +70 °C

www.knick.de

14163 Berlin

Made in Germany 01 80434



	Out active	Out passive	S1	S2	Terminals	
	5	6	1	2	3	+ / -
O	0 to 20mA			•	3	1 / 3.2
	0 to -20mA			•	3	1 / 3.2
	4 to 20mA			•	3	1 / 3.2
	0 to 10 V			•	3	3 / 3.2
	0 to -10 V			•	3	3 / 3.2
		4 to 20mA		•	3	1 / 3.2
	-20 to 20mA			•	3	1 / 3.2
	20 to -20mA			•	3	1 / 3.2
	4 to 20mA			•	3	1 / 3.2
		4 to 20mA		•	3	1 / 3.2
	-10 to 10 V			•	3	3 / 3.2
	10 to -10 V			•	3	3 / 3.2

Special function: _____

Zero trim active (calibrated ranges off) |

Test Voltage: Input - Output/Supply 5.4 kV - Output - Supply 4.3 kV -



OPEN TYPE PROCESS CONTROL EQUIPMENT E340287

Reinforced insulation 600 V CAT II

Reinforced insulation 300 V CAT III

Basic insulation 1000 V CAT III

Reinforced insulation 600 V CAT II

Reinforced insulation 300 V CAT III

O	Default	DIP Switch	On	S1	Terminals		
	In bipolar	In unipolar	1	2	3	4	+ / -
O	-100 to 100 V	0 to 100 V		•	5	3	6 / 3
	-80 to 80 V	0 to 80 V		•	5	3	6 / 3
	-60 to 60 V	0 to 60 V		•	5	3	6 / 3
	-50 to 50 V	0 to 50 V		•	5	3	6 / 3
	-30 to 30 V	0 to 30 V		•	5	3	6 / 3
	-20 to 20 V	0 to 20 V		•	5	3	6 / 3
	-10 to 10 V	0 to 10 V		•	5	3	6 / 3
	-5 to 5 V	0 to 5 V		•	5	3	6 / 3
	-300 to 300 mV	0 to 300 mV		•	5	2	6 / 2
	-200 to 200 mV	0 to 200 mV		•	5	2	6 / 2
	-150 to 150 mV	0 to 150 mV		•	5	2	6 / 2
	-120 to 120 mV	0 to 120 mV		•	5	2	6 / 2
	-100 to 100 mV	0 to 100 mV		•	5	2	6 / 2
	-90 to 90 mV	0 to 90 mV		•	5	2	6 / 2
	-60 to 60 mV	0 to 60 mV		•	5	2	6 / 2
	-30 to 30 mV	0 to 30 mV		•	5	2	6 / 2

Special function: _____

Power supply: 24 V DC \pm 25%, 1.5 W | 1.1 / 1.2 \pm / \pm

Knick >

VariTrans®

DC/DC-Transmitter

Type P29001P2/00 | ES02

No. 80435/0000000

Tamb -25 to +70 °C

www.knick.de

14163 Berlin

Made in Germany 01 80435



	Out active	Out passive	S1	S2	Terminals	
	5	6	1	2	3	+ / -
O	0 to 20mA			•	3	1 / 3.2
	0 to -20mA			•	3	1 / 3.2
	4 to 20mA			•	3	1 / 3.2
	0 to 10 V			•	3	3 / 3.2
	0 to -10 V			•	3	3 / 3.2
		4 to 20mA		•	3	1 / 3.2
	-20 to 20mA			•	3	1 / 3.2
	20 to -20mA			•	3	1 / 3.2
	4 to 20mA			•	3	1 / 3.2
		4 to 20mA		•	3	1 / 3.2
	-10 to 10 V			•	3	3 / 3.2
	10 to -10 V			•	3	3 / 3.2

Special function: _____

Zero trim active (calibrated ranges off) |

Test Voltage: Input - Output/Supply 5.4 kV - Output - Supply 4.3 kV -



OPEN TYPE PROCESS CONTROL EQUIPMENT E340287

Reinforced insulation 600 V CAT II

Reinforced insulation 300 V CAT III

Basic insulation 1000 V CAT III

Reinforced insulation 600 V CAT II

Reinforced insulation 300 V CAT III

Sonderausführungen (soweit vorhanden) einschließlich der Werte von kundenspezifisch parametrisierten Messbereichen werden auf dem jeweiligen Geräte-Typschild genannt.

Produktvarianten

20 ... 230 V AC/DC

O = Default		DIP Switch	● = On	S1	Terminals		
In bipolar		In unipolar	1	2	3	4	+ / -
O	-1000 to 1000 V	0 to 1000 V		●			5.3 / 6.3
	-950 to 950 V	0 to 950 V		●			5.3 / 6.3
	-900 to 900 V	0 to 900 V		●			5.3 / 6.3
	-800 to 800 V	0 to 800 V		●			5.3 / 6.3
	-750 to 750 V	0 to 750 V		●			5.3 / 6.3
	-700 to 700 V	0 to 700 V		●			5.3 / 6.3
	-600 to 600 V	0 to 600 V		●			5.3 / 6.3
	-500 to 500 V	0 to 500 V		●			5.3 / 6.3
	-450 to 450 V	0 to 450 V		●			5.2 / 6.2
	-400 to 400 V	0 to 400 V		●			5.2 / 6.2
	-350 to 350 V	0 to 350 V		●			5.2 / 6.2
	-300 to 300 V	0 to 300 V		●			5.2 / 6.2
	-250 to 250 V	0 to 250 V		●			5.2 / 6.2
	-200 to 200 V	0 to 200 V		●			5.2 / 6.2
	-150 to 150 V	0 to 150 V		●			5.2 / 6.2
	-100 to 100 V	0 to 100 V		●			5.2 / 6.2

Special function:

Power supply:	20 to 230 V AC / DC	1.1 / 1.2
± 10% AC:	45 to 440 Hz, 1.5 W	≈ / ≈

Knick VariTrans®

DC/DC-Transmitter

Type P29000P2/01 ES02

No. 81542/0000000

Tamb -25 to +70 °C

www.knick.de

14163 Berlin

Made in Germany **CE** 81542



		S1	S2	Terminals
		5	6	1 2 3 + / -
	Out active			
O	0 to 20mA		●	3.1 / 3.2
	0 to -20mA		●	3.1 / 3.2
	4 to 20mA		●	3.1 / 3.2
	0 to 10 V		●	3.3 / 3.2
	0 to -10 V		●	3.3 / 3.2
	4 to 20mA		●	3.1 / 3.2
	-20 to 20mA		●	3.1 / 3.2
	20 to -20mA		●	3.1 / 3.2
	4 to 20mA		●	3.1 / 3.2
	4 to 20mA		●	3.1 / 3.2
	-10 to 10 V		●	3.3 / 3.2
	10 to -10 V		●	3.3 / 3.2
		S2		4
O	Bandwith 10 kHz			
	Bandwith 10 Hz			
		S2		5
O	Calibrated ranges			
	Zero trim active (calibrated ranges off)		●	
Test	Input - Output/Supply	5.4	kV -	
Voltage:	Output - Supply	4.3	kV -	

UL OPEN TYPE PROCESS CONTROL EQUIPMENT LISTED E340287

Basic insulation 1000 V CAT III
Reinforced insulation 600 V CAT II
Reinforced insulation 300 V CAT III

O = Default		DIP Switch	● = On	S1	Terminals		
In bipolar		In unipolar	1	2	3	4	+ / -
O	-100 to 100 V	0 to 100 V		●			5.3 / 6.3
	-80 to 80 V	0 to 80 V		●			5.3 / 6.3
	-60 to 60 V	0 to 60 V		●			5.3 / 6.3
	-50 to 50 V	0 to 50 V		●			5.3 / 6.3
	-30 to 30 V	0 to 30 V		●			5.3 / 6.3
	-20 to 20 V	0 to 20 V		●			5.3 / 6.3
	-10 to 10 V	0 to 10 V		●			5.3 / 6.3
	-5 to 5 V	0 to 5 V		●			5.3 / 6.3
	-300 to 300 mV	0 to 300 mV		●			5.2 / 6.2
	-200 to 200 mV	0 to 200 mV		●			5.2 / 6.2
	-150 to 150 mV	0 to 150 mV		●			5.2 / 6.2
	-120 to 120 mV	0 to 120 mV		●			5.2 / 6.2
	-100 to 100 mV	0 to 100 mV		●			5.2 / 6.2
	-90 to 90 mV	0 to 90 mV		●			5.2 / 6.2
	-60 to 60 mV	0 to 60 mV		●			5.2 / 6.2
	-30 to 30 mV	0 to 30 mV		●			5.2 / 6.2

Special function:

Power supply:	20 to 230 V AC / DC	1.1 / 1.2
± 10% AC:	45 to 440 Hz, 1.5 W	≈ / ≈

Knick VariTrans®

DC/DC-Transmitter

Type P29001P2/01 ES02

No. 81543/0000000

Tamb -25 to +70 °C

www.knick.de

14163 Berlin

Made in Germany **CE** 81543



		S1	S2	Terminals
		5	6	1 2 3 + / -
	Out active			
O	0 to 20mA		●	3.1 / 3.2
	0 to -20mA		●	3.1 / 3.2
	4 to 20mA		●	3.1 / 3.2
	0 to 10 V		●	3.3 / 3.2
	0 to -10 V		●	3.3 / 3.2
	4 to 20mA		●	3.1 / 3.2
	-20 to 20mA		●	3.1 / 3.2
	20 to -20mA		●	3.1 / 3.2
	4 to 20mA		●	3.1 / 3.2
	4 to 20mA		●	3.1 / 3.2
	-10 to 10 V		●	3.3 / 3.2
	10 to -10 V		●	3.3 / 3.2
		S2		4
O	Bandwith 10 kHz			
	Bandwith 10 Hz			
		S2		5
O	Calibrated ranges			
	Zero trim active (calibrated ranges off)		●	
Test	Input - Output/Supply	5.4	kV -	
Voltage:	Output - Supply	4.3	kV -	

UL OPEN TYPE PROCESS CONTROL EQUIPMENT LISTED E340287

Basic insulation 1000 V CAT III
Reinforced insulation 600 V CAT II
Reinforced insulation 300 V CAT III

Sonderausführungen (soweit vorhanden) einschließlich der Werte von kundenspezifisch parametrisierten Messbereichen werden auf dem jeweiligen Geräte-Typschild genannt.

Funktion

Das Eingangssignal wird in ein pulsweitenmoduliertes Signal umgesetzt und der Primärseite eines Transformators zugeführt. Auf der Sekundärseite wird das Pulsweitesignal in eingepprägten Strom bzw. aufgeprägte Spannung rückgewandelt.

Eine 3-Port-Trennung mit sicherer Trennung durch verstärkte Isolation nach EN 61140 bis zu 600 V AC/DC garantiert Personen- und Anlagenschutz sowie eine unverfälschte Übertragung der Messsignale. Bis 1000 V AC/DC wird Basisisolation bereitgestellt.

3-Port-Trennung der 3 Kreise: Eingänge, Ausgänge und Stromversorgung

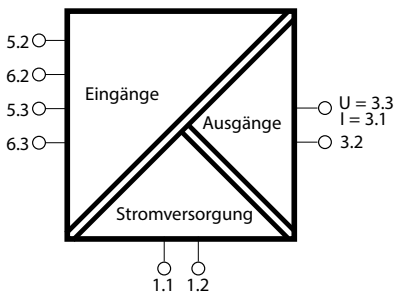

Bedienelemente (Kopfplatte)

Schalter S1	Funktion (Werkseinstellung fett gedruckt)	
S1: 1 ... 4	Eingangsbereich	
S1: 5 ... 6	Ausgangsbereich	
Schalter S2	ON	OFF
S2: 1	Ausgang aktiv	Ausgang passiv
S2: 2	Spannungsausgang	Stromausgang
S2: 3	Ausgang invertiert	Ausgang nicht invertiert
S2: 4	Grenzfrequenz 10 Hz	Grenzfrequenz 10 kHz
S2: 5	Offset-Poti aktiv	kalibrierter Messbereich

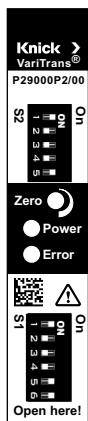

Schalter S2

Potentiometer (Ausgangs-Offset, max. $\pm 5\%$)

Status-LED (grün)

Alarm-LED (rot), leuchtet beim Einschalten des Gerätes kurz auf.
Das Warnzeichen bedeutet: Betriebsanleitung lesen.

Schalter S1

Zustandssignalisierung

grüne LED: Versorgungsspannung vorhanden

rote LED: Fehler: Bürde überprüfen. Kann der Fehler nicht abgestellt werden, Gerät zur Reparatur einsenden.

Hinweis: Beim Einschalten blinkt die rote LED kurz auf und signalisiert damit, dass die Bürdenüberwachung bestimmungsgemäß arbeitet.

Eingangsbereiche

Eingangsbereiche P 29000 P2/0x (Werkseinstellung: **Bereich 1**)

Nr.	Eingangsbereich		Schalter S1: 1 ... 4	Eingangswi- derstand	Eingangs- klemmen
	bipolar	unipolar			
1	-1000 ... 1000 V	0 ... 1000 V	0000	4 MΩ	5.3 / 6.3
2	-950 ... 950 V	0 ... 950 V	0010	4 M Ω	5.3 / 6.3
3	-900 ... 900 V	0 ... 900 V	0100	4 M Ω	5.3 / 6.3
4	-800 ... 800 V	0 ... 800 V	0110	4 M Ω	5.3 / 6.3
5	-750 ... 750 V	0 ... 750 V	1000	4 M Ω	5.3 / 6.3
6	-700 ... 700 V	0 ... 700 V	1010	4 M Ω	5.3 / 6.3
7	-600 ... 600 V	0 ... 600 V	1100	4 M Ω	5.3 / 6.3
8	-500 ... 500 V	0 ... 500 V	1110	4 M Ω	5.3 / 6.3
9	-450 ... 450 V	0 ... 450 V	0001	2 M Ω	5.2 / 6.2
10	-400 ... 400 V	0 ... 400 V	0011	2 M Ω	5.2 / 6.2
11	-350 ... 350 V	0 ... 350 V	0101	2 M Ω	5.2 / 6.2
12	-300 ... 300 V	0 ... 300 V	0111	2 M Ω	5.2 / 6.2
13	-250 ... 250 V	0 ... 250 V	1001	2 M Ω	5.2 / 6.2
14	-200 ... 200 V	0 ... 200 V	1011	2 M Ω	5.2 / 6.2
15	-150 ... 150 V	0 ... 150 V	1101	2 M Ω	5.2 / 6.2
16	-100 ... 100 V	0 ... 100 V	1111	2 M Ω	5.2 / 6.2

Eingangsbereiche P 29001 P2/0x (Werkseinstellung: Bereich 1)

Nr.	Eingangsbereich		Schalter S1: 1 ... 4	Eingangs- widerstand	Eingangs- klemmen
	bipolar	unipolar			
1	-100 ... 100 V	0 ... 100 V	0000	400 kΩ	5.3 / 6.3
2	-80 ... 80 V	0 ... 80 V	0010	400 k Ω	5.3 / 6.3
3	-60 ... 60 V	0 ... 60 V	0100	400 k Ω	5.3 / 6.3
4	-50 ... 50 V	0 ... 50 V	0110	400 k Ω	5.3 / 6.3
5	-30 ... 30 V	0 ... 30 V	1000	400 k Ω	5.3 / 6.3
6	-20 ... 20 V	0 ... 20 V	1010	400 k Ω	5.3 / 6.3
7	-10 ... 10 V	0 ... 10 V	1100	400 k Ω	5.3 / 6.3
8	-5 ... 5 V	0 ... 5 V	1110	400 k Ω	5.3 / 6.3
9	-300 ... 300 mV	0 ... 300 mV	0001	10 k Ω	5.2 / 6.2
10	-200 ... 200 mV	0 ... 200 mV	0011	10 k Ω	5.2 / 6.2
11	-150 ... 150 mV	0 ... 150 mV	0101	10 k Ω	5.2 / 6.2
12	-120 ... 120 mV	0 ... 120 mV	0111	10 k Ω	5.2 / 6.2
13	-100 ... 100 mV	0 ... 100 mV	1001	10 k Ω	5.2 / 6.2
14	-90 ... 90 mV	0 ... 90 mV	1011	10 k Ω	5.2 / 6.2
15	-60 ... 60 mV	0 ... 60 mV	1101	10 k Ω	5.2 / 6.2
16	-30 ... 30 mV	0 ... 30 mV	1111	10 k Ω	5.2 / 6.2

Ausgangsbereiche

Ausgangsbereiche P 2900* P2/0x (Werkseinstellung: Bereich 1)

Nr.	Eingang	Ausgang aktiv	Ausgang passiv	S1: 5 ... 6	S2: 1 ... 3	Ausgangs- klemmen
1	Unipolar	0 ... 20 mA		00	100	3.1 / 3.2
2	Unipolar	0 ... -20 mA		00	101	3.1 / 3.2
3	Unipolar	4 ... 20 mA		11	100	3.1 / 3.2
4	Unipolar	0 ... 10 V		01	110	3.3 / 3.2
5	Unipolar	0 ... -10 V		01	111	3.3 / 3.2
6	Unipolar		4 ... 20 mA	11	001	3.1 / 3.2
7	Bipolar	-20 ... 20 mA		00	100	3.1 / 3.2
8	Bipolar	20 ... -20 mA		00	101	3.1 / 3.2
9	Bipolar	4 ... 20 mA		10	100	3.1 / 3.2
10	Bipolar		4 ... 20 mA	10	001	3.1 / 3.2
11	Bipolar	-10 ... 10 V		01	110	3.3 / 3.2
12	Bipolar	10 ... -10 V		01	111	3.3 / 3.2

Montage und elektrischer Anschluss

▲ WARNUNG! Berührunggefährliche Spannungen.

Bei Anwendungen mit hohen Arbeitsspannungen ist genügend Abstand bzw. Isolation zu Nebengeräten und Berührungsschutz einzuhalten.

Die Geräte müssen unter Bedingungen installiert werden, die den Verschmutzungsgrad 2 oder besser gewährleisten.

Die Geräte werden auf Tragschienen gemäß EN 60715 mit einer Breite von 35 mm aufgerastet und seitlich durch geeignete Endhalter fixiert. Klemmenbelegung siehe Maßzeichnung. Anschlussquerschnitt: 0,2 mm² ... 2,5 mm² (AWG 24-12).

Hinweis: Nur Kupferkabel verwenden, die bis mindestens 75 °C prozesstemperaturbeständig sind.

Klemmenbelegung und Abmessungen

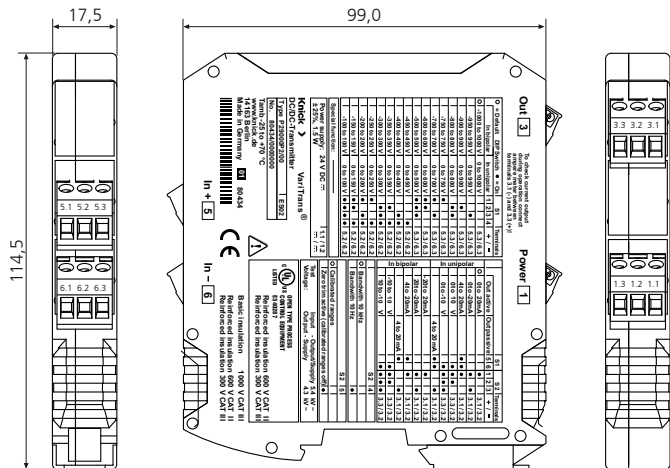

- 1.1** Hilfsenergie*
- 3.1** Ausgang Strom** (passiv/aktiv)
- 5.1** nicht belegt
- 6.1** nicht belegt
- 1.2** Hilfsenergie*
- 3.2** Ausgang GND
- 5.2** Eingang positiv***
- 6.2** Eingang negativ***
- 1.3** nicht belegt
- 3.3** Ausgang Spannung**
- 5.3** Eingang positiv***
- 6.3** Eingang negativ***

* Bei Versorgung mit Gleichspannung ist die Polarität beliebig
 ** Die Signalausgänge sind leerlauf- bzw. kurzschlussfest
 *** Das für den jeweils gewählten Messbereich zu verwendende Eingangs-Klemmenpaar 5.2/6.2 oder 5.3/6.3 ist auf dem Typschild und den Seiten 13, 14 und 18 angegeben.

Beschaltungsvarianten Eingang

P 29000 P2/0x: 500 ... 1000 V

P 29001 P2/0x: 300 mV ... 100 V

P 29000 P2/0x: 100 ... 500 V

P 29001 P2/0x: 0 ... 300 mV

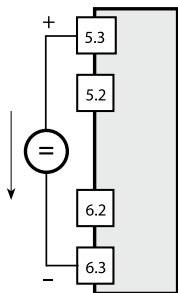

Spannungsmessung

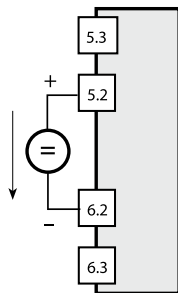

Spannungsmessung

P 29001 P2/0x: 0 ... 300 mV

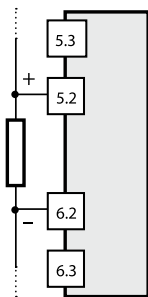

Shuntspannungsmessung

Beschaltungsvarianten Ausgang

Stromausgang aktiv

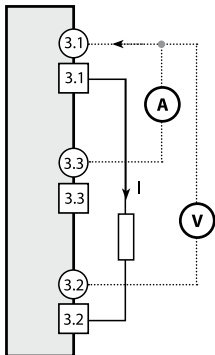

Die hier dargestellte Strommessung dient der Überprüfung des Ausgangsstroms ohne Öffnen des Ausgangskreises. Die Klemmen 3.1 und 3.3 stellen den Monitorausgang dar.



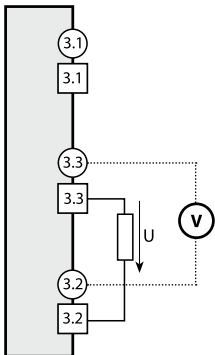

Am Monitorausgang kann der Ausgangsstrom unterbrechungsfrei mit einem Multi-Meter (an den Prüfbuchsen) temporär kontrolliert oder ein potentialfreies Anzeigergerät dauerhaft angeschlossen werden.

Eine Unterbrechung im Monitorausgang, z.B. wegen eines Leitungsbruchs führt nicht zu einer Beeinträchtigung oder dem Ausfall des primären Stromausgangs.

Spannungsausgang



Legende

-  Prüfbuchse
-  Klemme
-  optionale Spannungsmessung
-  optionale Strommessung
(nur DC-Ströme können korrekt gemessen werden)

Beschaltungsvarianten Ausgang

Das Gerät ist für „Ausgang passiv“ konfiguriert (unipolar/bipolar):

S2-1	U Ausgang	Verhalten bei fehlender Versorgungsspannung
ON	14 V	Der fremdgetriebene Ausgangsstrom steigt auf ca. 57 mA, die rote LED glimmt dabei leicht.
OFF	24 V	Der fremdgetriebene Ausgangsstrom steigt auf ca. 28 mA.



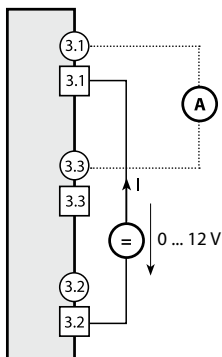

Stromausgang passiv
für Speisespannungen bis 12 V
(S2-1 = ON)

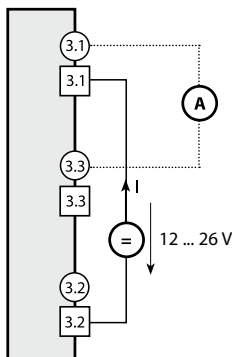

Stromausgang passiv
für Speisespannungen 12 ... 26 V
(S2-1 = OFF)



Legende

-  Prüfbuchse
-  Klemme
-  optionale Spannungsmessung
-  optionale Strommessung
(nur DC-Ströme können korrekt gemessen werden)

Prüfbuchsen

⚠ WARNUNG! Berührungsgefährliche Spannungen.

Bei Anwendungen mit hohen Arbeitsspannungen ist auf genügend Abstand bzw. Isolation zu Nebengeräten und auf Berührungsschutz zu achten. Verwenden Sie unbedingt hochspannungssichere Prüfspitzen mit Berührungsschutz!

Der Hochspannungstrennverstärker VariTrans® P 2900* P2 verfügt über Prüfbuchsen, die sich jeweils oberhalb der Anschlussdrähte an der entsprechenden Signalklemme befinden (siehe Abbildung). Das ermöglicht die Funktionskontrolle bzw. Signalverfolgung.

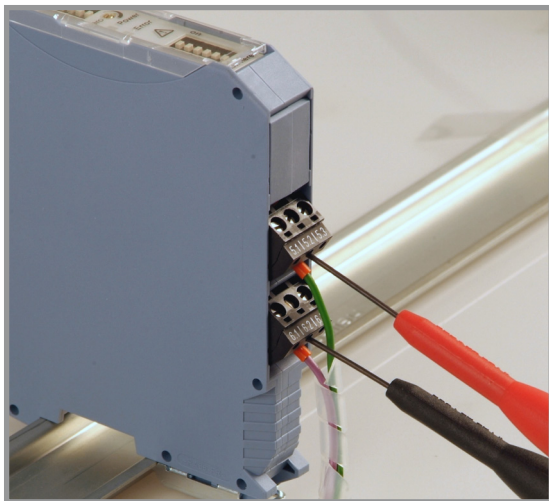

Kennlinienverläufe

Übertragungskennlinie mit Darstellung des einstellbaren Offsets. Bis 105 % Aussteuerung arbeitet das Gerät linear mit voller Genauigkeit.

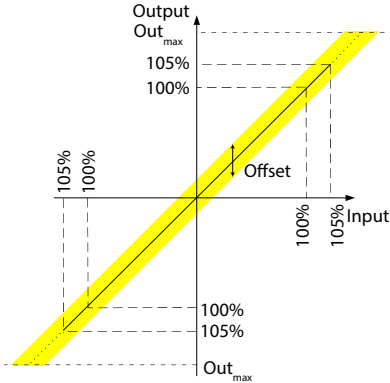

Übertragungskennlinie mit einstellbarem RangeLimit min. (Sonderausführung) und einstellbarem Offset

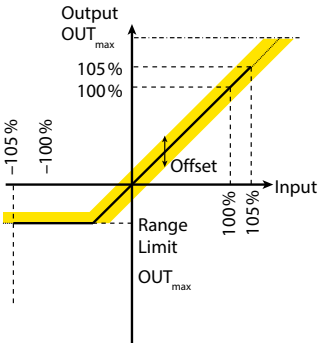

Kennlinienverläufe

Invertierende Übertragungskennlinie mit einstellbarem RangeLimit max. (Sonderausführung) und einstellbarem Offset

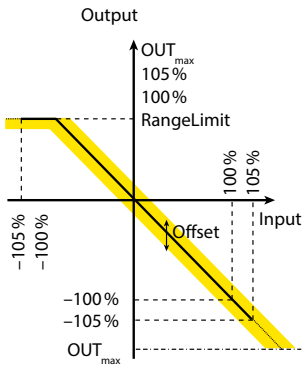

Technische Daten

Eingangsdaten Spannung

Eingangsbereich	max. \pm 1000 V DC	
Überlastbarkeit (dauernd)	0 ... 1 V	max. \pm 30 V
	1 ... 100 V	max. \pm 500 V
	100 ... 500 V	max. \pm 600 V
	500 ... 1000 V	max. \pm 1200 V
Eingangswiderstand	0 ... 1 V	ca. 10 k Ω
	1 ... 100 V	ca. 400 k Ω
	100 ... 500 V	ca. 2 M Ω
	500 ... 1000 V	ca. 4 M Ω
Kabelbrucherkennung (Sonderausführung)	< 300 μ A	

Technische Daten

Ausgangsdaten

Ausgang aktiv	0/4 ... 20 mA bzw. 0 ... 10 V oder -20 ... 20 mA bzw. -10 ... 10 V
Ausgang passiv	4 ... 20 mA
max. Bürde (Strom)	aktiv ≤ 12 V (600 Ω bei 20 mA) passiv 12 ... 26 V
max. Last (Spannung)	≤ 10 mA (1 k Ω bei 10 V)
Überlastbarkeit bei extern angelegter Spannung	± 30 V
Verschiebung	werksseitig bis ± 150 %
Übersteuerungsbereich	Stromausgang: > 22 mA (max. 26 mA) Spannungsausgang: < 15 V
Offsetabgleich	± 5 %
Restwelligkeit	< 10 mV eff
Spannungsabfall bei Messung des Ausgangsstromes an den Prüfbuchsen 3.1 und 3.3	max. 150 mV

Übertragungsverhalten

Verstärkungsfehler	Eingang ≤ 1 V	$\leq 0,1$ % v. M.
	Eingang > 1 V	$\leq 0,2$ % v. M.
Offset	$\leq 0,1$ % vom Eingangsbereich (Endwert)	
Linearer Aussteuerungsbereich	-5 % bis 105 % der Eingangsmessspanne	
Signalisierung Bürdenfehler	Rote LED an der Front	
Einstellzeit t_{99} *	< 200 ms oder < 200 μ s, umschaltbar	
Grenzfrequenz	10 Hz oder 10 kHz, umschaltbar	

*) Zeit nach einer Änderung des Eingangswertes bis zum Erreichen des Ausgangswertes von 99 % des eingeschwungenen Zustands

Technische Daten

Gleichtaktunterdrückung	CMRR ¹	ca. 150 dB (DC/AC: 50 Hz)
Eingangsbereich ≤ 1 V	T-CMRR ²	ca. 100 dB (1000 V, $t_r = 1 \mu\text{s}$)
Gleichtaktunterdrückung	CMRR ¹	DC: ca. 150 dB
Eingangsbereich > 1 V		AC 50 Hz: ca. 120 dB
Temperatureinfluss ³	Eingang ≤ 1 V	< 50 ppm/K v. E.
	Eingang > 1 V	< 80 ppm/K v. E.

Hilfsenergie

P2900*P2/00	24 V DC ± 25 %
P2900*P2/01	20 ... 230 V AC/DC ± 10 %; AC: 45 Hz bis 440 Hz
Leistungsaufnahme	1,5 W

¹ Common-Mode Rejection Ratio: Differenzspannungsverstärkung :
Gleichtaktspannungsverstärkung

² Transient Common-Mode Rejection Ratio: Differenz-Gleichspannungsverstärkung :
Gleichtakttransienten-Scheitelwertverstärkung

³ Referenztemperatur für TK-Angaben = 23 °C, mittlerer TK

Technische Daten

Isolation

Galvanische Trennung	3-Port-Trennung zwischen Eingang, Ausgang und Hilfsenergie
----------------------	--

Prüfspannung	5,4 kV AC Eingang gegen Ausgang und Hilfsenergie (UL 4,3 kV) 4,3 kV AC Hilfsenergie gegen Ausgang
--------------	--

Arbeitsspannung (Basisisolierung) bei Verschmutzungsgrad 2 gemäß IEC 61010-1, EN 61010-1 und UL 61010-1 zwischen allen Kreisen. Bei Anwendungen mit Kontakt zum Benutzer ist eine weitere Schutzmaßnahme notwendig.	CAT II (OV II): 1000 V AC/DC CAT III (OV III): 1000 V AC/DC (Einschränkung für UL 61010-1: gilt nur für P2900xP2/01)
---	--

Schutz gegen gefährliche Körperströme durch verstärkte Isolierung bei Verschmutzungsgrad 2 gemäß IEC 61010-1, EN 61010-1 und UL 61010-1 zwischen allen Kreisen.	CAT II (OV II): 600 V AC/DC CAT III (OV III): 300 V AC/DC (keine Einschränkung)
---	---

Schutz gegen gefährliche
Körperströme

▲ WARNUNG! Berührunggefährliche
Spannungen.

Bei Anwendungen mit hohen Arbeits-
spannungen ist auf genügend Abstand
bzw. Isolation zu Nebengeräten und auf
Berührungsschutz zu achten. Bei Anwen-
dungen oberhalb von Arbeitsspan-
nungen der verstärkten Isolierung und
Kontakt zum Benutzer, ist eine weitere
Schutzmaßnahme notwendig, um den
Benutzer vor gefährlichen Spannungen
(im Fehlerfall) auf dem Ausgangssignal
oder dem Hutschienebusverbinder zu
schützen.

Normen und Zulassungen

EMV

Produktfamilienorm EN 61326-1
Störaussendung: Klasse B
Störfestigkeit: Industriebereich

USA / Kanada, UL

cULus Listed
OPEN TYPE PROCESS CONTROL EQUIP-
MENT
File: E340287, UL 61010-1, CAN/CSA
C22.2 NO. 61010-1

Technische Daten

weitere Daten

Umgebungstemperatur	Betrieb: -25 ... +70 °C (min. Starttemp.: -40 °C) Betrieb mit passivem Ausgang: -25 ... +60 °C Transport und Lagerung: -40 ... +85 °C
Bauform	Anreihgehäuse mit Schraubklemmen Gehäusebreite 17,5 mm
Einbaulage	Senkrecht oder waagrecht
Durchmesser der Prüfbuchsen	2,1 mm
Schutzart	Gehäuse IP 40, Klemmen IP 20
Umgebungsbedingungen	Ortsfester Einsatz, Verwendung in Innenräumen Relative Luftfeuchte: 5 ... 95 %, keine Betauung Luftdruck: 750 ... 1060 hPa Höhenlage bis 2000 m; bei Höhen >2000 m reduzieren sich die zulässigen Arbeitsspannungen
Befestigung	mit Schnappbefestigung für Tragschiene 35 mm nach EN 60715
Gewicht	ca. 120 g

Wartung, Fehlersuche, Entsorgung

Der Hochspannungstrennverstärker ist wartungsfrei. Der Hochspannungstrennverstärker darf nicht geöffnet werden.

Warenrücksendung

Hochspannungstrennverstärker nicht öffnen! Bei Beanstandungen kontaktieren Sie vor der Rücksendung des Hochspannungstrennverstärkers die Fa. Knick und beachten Sie die Angaben zum Rücksendeverfahren auf der Webseite:

www.knick.de > Service > Reparaturen

Reinigung

Der Hochspannungstrennverstärker kann mit ölfreier Druckluft gereinigt werden.

- Vor der Reinigung den Eingang und die Hilfsenergie des Hochspannungstrennverstärkers spannungsfrei schalten!

▲ WARNUNG! Berührungsgefährliche Spannungen.

Bei allen Maßnahmen zur Fehlersuche die Sicherheitshinweise beachten, siehe Seite 30.

Erste Maßnahmen zur Fehlersuche

- Den korrekten Anschluss aller isolierten Leitungen prüfen.
- Die Hilfsenergie prüfen.
 - Wenn die Power-LED grün leuchtet, ist Hilfsenergie vorhanden.
- Das Eingangssignal prüfen
 - Prüfen, ob das Eingangssignal tatsächlich anliegt.
- Das Ausgangssignal prüfen.
 - Den Spannungsausgang z. B. mit Multimeter an den Prüfbuchsen der Ausgangsklemmen messen.
 - Den Stromausgang über den Monitor-Ausgang z. B. mit Multimeter an den Prüfbuchsen der Ausgangsklemmen messen.

Wartung, Fehlersuche, Entsorgung

- Eine mögliche Überbürdung des Stromausgangs prüfen.
 - Die Spannung an den Strom-Ausgangsklemmen sowie den Ausgangsstrom messen und daraus die Bürde bestimmen. Die Bürde darf 600 Ohm nicht überschreiten.
- Eine mögliche Überlastung des Spannungsausgangs prüfen.
 - Messen Sie den Strom in der Spannungs-Ausgangsschleife sowie die Ausgangsspannung. Der resultierende Lastwiderstand darf 1000 Ohm nicht unterschreiten.
- Die Übersteuerung des Eingangs prüfen.
 - Bei negativer Übersteuerung wird ein großes negatives Signal ausgegeben
 - Bei positiver Übersteuerung wird ein großes positives Signal ausgegeben
- Den Ausgang prüfen.
 - Durch Messung z.B. mit einem Multimeter prüfen, ob das Ausgangssignal mit dem Eingangssignal und dem gewählten Messbereich übereinstimmt.

Lagerung

Die Angaben zu den Lagertemperaturen und der relativen Feuchte in den technischen Daten beachten.

Entsorgung

Die nationalen Vorschriften zur Entsorgung von Elektro- und Elektronikgeräten beachten!

Der Hochspannungstrennverstärker kann bei einem zertifizierten Entsorgungsunternehmen zur fachgerechten Entsorgung abgegeben werden.

Lieferprogramm

		Bestell-Nr.					
	P2900P2 /	0	_	-	-	-	-
Hilfsenergie 24 V DC	Standardgerät	0					
Hilfsenergie VariPower®- Weitbereichsnetzteil (20 ... 230 V AC/DC)	Standardgerät	1					
Ausführung	Kundenwunsch			n	n	n	n
	P29001P2 /	0	_	-	-	-	-
Hilfsenergie 24 V DC	Standardgerät	0					
Hilfsenergie VariPower®- Weitbereichsnetzteil (20 ... 230 V AC/DC)	Standardgerät	1					
Ausführung	Kundenwunsch			n	n	n	n

Sonderausführungen

Kundenspezifische Messbereiche	Es werden bis zu 192 kalibriert umschaltbare Bereiche werksseitig kundenspezifisch parametrier.
Shuntbruchererkennung	Bei einem offenen Spannungseingang geht der Ausgang auf Max.
RangeLimit (Bereichsgrenzen)	Der Ausgangswert kann eine defi- nierte Grenze nicht unter- oder über- schreiten. Der Grenzwert und das Ver- halten bei Über- oder Unterschreiten des Grenzwertes werden werksseitig kundenspezifisch parametrier.

Die Sonderausführungen gelten immer für alle Messbereiche.
Eingänge für Strom auf Anfrage. Die Sonderausführungen (soweit
vorhanden) einschließlich der Werte von kundenspezifisch paramet-
rierten Messbereichen werden auf dem jeweiligen Geräte-Typschild
genannt.

Zubehör

	Order No.
IsoPower® A 20900 Stromversorgung 24V DC, 1A A 20900 H4 Stromversorgung	A20900H4
Hutschienen-Busverbinder: Entnahme der Versorgungsspannung aus dem A 20900 H4 (2 Stück erforderlich) sowie zur Einleitung der Ver- sorgungsspannung in den Hochspannungstrenn- verstärker.	ZU0678
Einspeiseklemme, Einspeisung der Versorgungs- spannung in Hutschienen-Busverbinder ZU0628 Notwendig, wenn mehr als 5 Trenner P 2900*P* eingesetzt werden sollen. Redundante Versorgung aus zwei Quellen möglich.	ZU0677
Hutschienen-Busverbinder: Entnahme der Versor- gungsspannung aus der Einspeiseklemme ZU0677	ZU0628



P 2900*P*

Hutschienen-Busverbinder
3 x ZU 0678

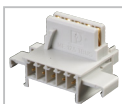

IsoPower® A 20900 Stromversorgung
A 20900 H4

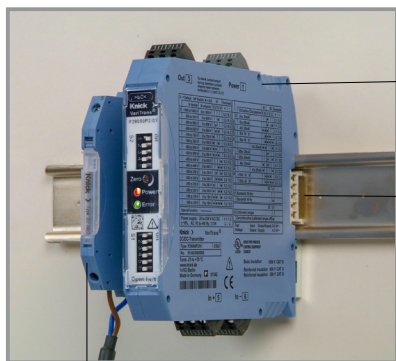

P 2900*P*

Hutschienen-Busverbinder
1 x ZU 0628 + 1 x ZU 0678

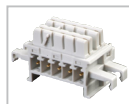

Einspeiseklemme
ZU 0677

User Manual
English

VariTrans P2900*P2

High Voltage Transducers

Read before installation.
Keep for future use.

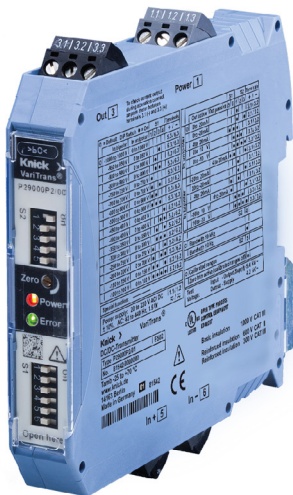

Table of Contents

Safety	40
Symbols and Markings.....	41
Abbreviations and Designations.....	42
Intended Use	43
Block Diagram.....	44
Rating Plates.....	45
Function	47
Control Elements (Head Plate).....	48
Input Ranges	49
Output Ranges.....	51
Mounting and Electrical Connection.....	52
Terminal Assignment and Dimensions	53
Input Wiring Variants.....	54
Output Wiring Variants.....	55
Test Jacks.....	57
Characteristic Curves	58
Specifications	60
Maintenance, Troubleshooting, Disposal	66
Product Range	68
Accessories.....	69

Safety

▲ WARNING! Shock potential.

For applications with high working voltages, take measures to prevent accidental contact and make sure that there is sufficient distance or insulation between adjacent devices.

Personnel Requirements

Installation, commissioning, operation, maintenance, and shutdown of the product shall only be performed by personnel authorized by the operator and specially trained in handling and operating the product. The operator must ensure that personnel are sufficiently qualified for the area in which the product is being used, in accordance with the applicable local and national codes and regulations.

For Your Safety:

- Save this user manual for as long as you use the product.
- Comply with the safety notes in this user manual and those found on the high voltage transducer itself.
- Install a two-pole circuit breaker between transducer and power grid.
- Do not connect the high voltage transducer to the power supply before it is professionally installed and configured.
- Do not change the measuring range during operation.

Electrostatic Discharge

Take precautionary measures against electrostatic discharge (ESD).

Symbols and Markings

Explanation of symbols and markings used in this user manual or on the housing of the high voltage transducer:

Symbol Meaning



Electric shock hazard!
DO NOT touch electrical components!





Read this user manual, observe the Specifications, and follow the safety instructions.



WARNING! Designates a situation that can lead to death or serious (irreversible) injury. Information on how to avoid will be provided.

Markings

Symbol	Meaning
	CE marking
	UL marking

▲ WARNING! Shock potential.

Applications with a working voltage of one of the circuits in excess of the specified reinforced insulation (see pages 45 and 63) and the possible contact of a person to a different circuit require an additional protective measure in accordance with the relevant codes and standards for the installation of electrical equipment (e.g. NEC), such as:

- Extra insulation
- Protective connection or shielding wire
- Automatic separation from the power supply
- Current or voltage limiting device

Abbreviations and Designations

	Meaning
Error	Error condition
Power	Power supply
Zero	Adjustment of potentiometer zero point
S1	Switch 1
S2	Switch 2
HV	High voltage
P2900*	P2900* is the generic name of the product line.

Intended Use

High voltage transducers measure voltage in different, switchable measuring ranges. They measure voltage and current via shunt resistor. Calibrated range selection is performed using DIP switches. The relevant input signal is mapped at the output as a standard signal 0/4 ... 20 mA or 0 ... 10 V, or as a bipolar output signal -20 ... 20 mA or -10 ... 10 V. The zero point can be adjusted using a connectable potentiometer.

The device has 3-port isolation between input, output, and power supply.

Up to 192 signal combinations are possible in one device.

Typical Areas of Application

- Inverters, rectifiers and frequency converters
- Electric drives and generators
- Power supply for welding units
- Solar and wind power farms
- Electrical power storage
- Monitoring charging processes and states
- Monitoring and controlling DC current supply units

Block Diagram

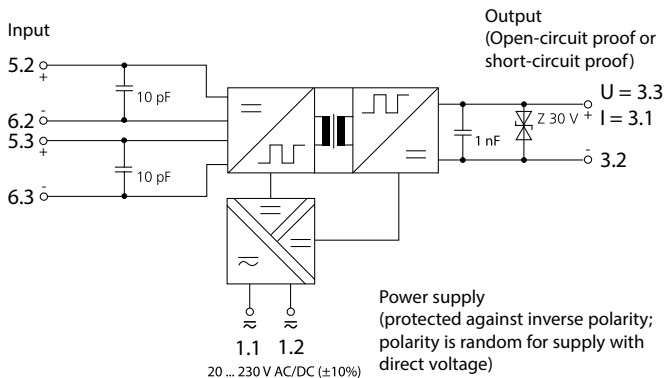

Rating Plates

Product Variants

24 V DC

O = Default	DIP Switch	On	S1	Terminals			
In bipolar		In unipolar	1	2	3	4	+ / -
O	-1000 to 1000 V	0 to 1000 V					5.3 / 6.3
	-950 to 950 V	0 to 950 V					5.3 / 6.3
	-900 to 900 V	0 to 900 V					5.3 / 6.3
	-800 to 800 V	0 to 800 V					5.3 / 6.3
	-750 to 750 V	0 to 750 V					5.3 / 6.3
	-700 to 700 V	0 to 700 V					5.3 / 6.3
	-600 to 600 V	0 to 600 V					5.3 / 6.3
	-500 to 500 V	0 to 500 V					5.3 / 6.3
	-450 to 450 V	0 to 450 V					5.2 / 6.2
	-400 to 400 V	0 to 400 V					5.2 / 6.2
	-350 to 350 V	0 to 350 V					5.2 / 6.2
	-300 to 300 V	0 to 300 V					5.2 / 6.2
	-250 to 250 V	0 to 250 V					5.2 / 6.2
	-200 to 200 V	0 to 200 V					5.2 / 6.2
	-150 to 150 V	0 to 150 V					5.2 / 6.2
	-100 to 100 V	0 to 100 V					5.2 / 6.2

Special function: _____

Power supply: 24 V DC \pm 25%, 1.5 W | 1.1 / 1.2 \pm / \pm

Knick > VariTrans®

DC/DC-Transmitter

Type P29000P2/00 | ES02

No. 80434/0000000

Tamb -25 to +70 °C

www.knick.de

14163 Berlin

Made in Germany 01 80434



	Out active	Out passive	S1	S2	Terminals	
	5	6	1	2	3	+ / -
O	0 to 20mA					3.1 / 3.2
	0 to -20mA					3.1 / 3.2
	4 to 20mA					3.1 / 3.2
	0 to 10 V					3.3 / 3.2
	0 to -10 V					3.3 / 3.2
		4 to 20mA				3.1 / 3.2
	-20 to 20mA					3.1 / 3.2
	20 to -20mA					3.1 / 3.2
	4 to 20mA					3.1 / 3.2
		4 to 20mA				3.1 / 3.2
	-10 to 10 V					3.3 / 3.2
	10 to -10 V					3.3 / 3.2

Bandwidth 10 kHz | S2 | 4 |

Bandwidth 10 Hz | | |

Calibrated ranges | S2 | 5 |

Zero trim active (calibrated ranges off) | |

Test Voltage: Input - Output/Supply 5.4 kV - Output - Supply 4.3 kV -

UL **US** LISTED OPEN TYPE PROCESS CONTROL EQUIPMENT E340287

Reinforced insulation 600 V CAT II
Reinforced insulation 300 V CAT III

Basic insulation 1000 V CAT III

Reinforced insulation 600 V CAT II

Reinforced insulation 300 V CAT III

O = Default	DIP Switch	On	S1	Terminals			
In bipolar		In unipolar	1	2	3	4	+ / -
O	-100 to 100 V	0 to 100 V					5.3 / 6.3
	-80 to 80 V	0 to 80 V					5.3 / 6.3
	-60 to 60 V	0 to 60 V					5.3 / 6.3
	-50 to 50 V	0 to 50 V					5.3 / 6.3
	-30 to 30 V	0 to 30 V					5.3 / 6.3
	-20 to 20 V	0 to 20 V					5.3 / 6.3
	-10 to 10 V	0 to 10 V					5.3 / 6.3
	-5 to 5 V	0 to 5 V					5.3 / 6.3
	-300 to 300 mV	0 to 300 mV					5.2 / 6.2
	-200 to 200 mV	0 to 200 mV					5.2 / 6.2
	-150 to 150 mV	0 to 150 mV					5.2 / 6.2
	-120 to 120 mV	0 to 120 mV					5.2 / 6.2
	-100 to 100 mV	0 to 100 mV					5.2 / 6.2
	-90 to 90 mV	0 to 90 mV					5.2 / 6.2
	-60 to 60 mV	0 to 60 mV					5.2 / 6.2
	-30 to 30 mV	0 to 30 mV					5.2 / 6.2

Special function: _____

Power supply: 24 V DC \pm 25%, 1.5 W | 1.1 / 1.2 \pm / \pm

Knick > VariTrans®

DC/DC-Transmitter

Type P29001P2/00 | ES02

No. 80435/0000000

Tamb -25 to +70 °C

www.knick.de

14163 Berlin

Made in Germany 01 80435



	Out active	Out passive	S1	S2	Terminals	
	5	6	1	2	3	+ / -
O	0 to 20mA					3.1 / 3.2
	0 to -20mA					3.1 / 3.2
	4 to 20mA					3.1 / 3.2
	0 to 10 V					3.3 / 3.2
	0 to -10 V					3.3 / 3.2
		4 to 20mA				3.1 / 3.2
	-20 to 20mA					3.1 / 3.2
	20 to -20mA					3.1 / 3.2
	4 to 20mA					3.1 / 3.2
		4 to 20mA				3.1 / 3.2
	-10 to 10 V					3.3 / 3.2
	10 to -10 V					3.3 / 3.2

Bandwidth 10 kHz | S2 | 4 |

Bandwidth 10 Hz | | |

Calibrated ranges | S2 | 5 |

Zero trim active (calibrated ranges off) | |

Test Voltage: Input - Output/Supply 5.4 kV - Output - Supply 4.3 kV -

UL **US** LISTED OPEN TYPE PROCESS CONTROL EQUIPMENT E340287

Reinforced insulation 600 V CAT II
Reinforced insulation 300 V CAT III

Basic insulation 1000 V CAT III

Reinforced insulation 600 V CAT II

Reinforced insulation 300 V CAT III

Special designs (if available), including the values of customer-specific measuring ranges are designated on the corresponding device rating plate.

Product Variants

20 ... 230 V AC/DC

O = Default	DIP Switch	● = On	S1	Terminals			
				1	2	3	4
	In bipolar						+ / -
O	-1000 to 1000 V	0 to 1000 V	●	●	●	●	5.3 / 6.3
	-950 to 950 V	0 to 950 V	●	●	●	●	5.3 / 6.3
	-900 to 900 V	0 to 900 V	●	●	●	●	5.3 / 6.3
	-800 to 800 V	0 to 800 V	●	●	●	●	5.3 / 6.3
	-750 to 750 V	0 to 750 V	●	●	●	●	5.3 / 6.3
	-700 to 700 V	0 to 700 V	●	●	●	●	5.3 / 6.3
	-600 to 600 V	0 to 600 V	●	●	●	●	5.3 / 6.3
	-500 to 500 V	0 to 500 V	●	●	●	●	5.3 / 6.3
	-450 to 450 V	0 to 450 V	●	●	●	●	5.2 / 6.2
	-400 to 400 V	0 to 400 V	●	●	●	●	5.2 / 6.2
	-350 to 350 V	0 to 350 V	●	●	●	●	5.2 / 6.2
	-300 to 300 V	0 to 300 V	●	●	●	●	5.2 / 6.2
	-250 to 250 V	0 to 250 V	●	●	●	●	5.2 / 6.2
	-200 to 200 V	0 to 200 V	●	●	●	●	5.2 / 6.2
	-150 to 150 V	0 to 150 V	●	●	●	●	5.2 / 6.2
	-100 to 100 V	0 to 100 V	●	●	●	●	5.2 / 6.2

Special function:

Power supply: 20 to 230 V AC/ DC 1.1 / 1.2
 ± 10%, AC: 45 to 440 Hz, 1.5 W ~ / ~

Knick VariTrans®

DC/DC-Transmitter

Type P29000P2/01 ES02

No. 81542/0000000

Tamb -25 to +70 °C

www.knick.de

14163 Berlin

Made in Germany  81542



O	Out active	Out passive	S1	S2	Terminals			
					5	6	1	2
								+ / -
O	0to 20mA		●	●	●	●	●	3.1 / 3.2
	0to -20mA		●	●	●	●	●	3.1 / 3.2
	4to 20mA		●	●	●	●	●	3.1 / 3.2
	0to 10 V		●	●	●	●	●	3.3 / 3.2
	0to -10 V		●	●	●	●	●	3.3 / 3.2
		4 to 20mA	●	●	●	●	●	3.1 / 3.2
	-20to 20mA		●	●	●	●	●	3.1 / 3.2
	20to -20mA		●	●	●	●	●	3.1 / 3.2
	4to 20mA		●	●	●	●	●	3.1 / 3.2
		4 to 20mA	●	●	●	●	●	3.1 / 3.2
	-10to 10 V		●	●	●	●	●	3.3 / 3.2
	10to -10 V		●	●	●	●	●	3.3 / 3.2

S2 | 4 |

Bandwith 10 kHz

Bandwith 10 Hz

S2 | 5 |

Calibrated ranges

Zero trim active (calibrated ranges off)

Test Voltage: Input - Output/Supply 5.4 kV -
Output - Supply 4.3 kV -

 OPEN TYPE PROCESS CONTROL EQUIPMENT LISTED E340287

Basic insulation 1000 V CAT III
 Reinforced insulation 600 V CAT II
 Reinforced insulation 300 V CAT III

O = Default	DIP Switch	● = On	S1	Terminals			
				1	2	3	4
	In bipolar						+ / -
O	-100 to 100 V	0 to 100 V	●	●	●	●	5.3 / 6.3
	-80 to 80 V	0 to 80 V	●	●	●	●	5.3 / 6.3
	-60 to 60 V	0 to 60 V	●	●	●	●	5.3 / 6.3
	-50 to 50 V	0 to 50 V	●	●	●	●	5.3 / 6.3
	-30 to 30 V	0 to 30 V	●	●	●	●	5.3 / 6.3
	-20 to 20 V	0 to 20 V	●	●	●	●	5.3 / 6.3
	-10 to 10 V	0 to 10 V	●	●	●	●	5.3 / 6.3
	-5 to 5 V	0 to 5 V	●	●	●	●	5.3 / 6.3
	-300 to 300 mV	0 to 300 mV	●	●	●	●	5.2 / 6.2
	-200 to 200 mV	0 to 200 mV	●	●	●	●	5.2 / 6.2
	-150 to 150 mV	0 to 150 mV	●	●	●	●	5.2 / 6.2
	-120 to 120 mV	0 to 120 mV	●	●	●	●	5.2 / 6.2
	-100 to 100 mV	0 to 100 mV	●	●	●	●	5.2 / 6.2
	-90 to 90 mV	0 to 90 mV	●	●	●	●	5.2 / 6.2
	-60 to 60 mV	0 to 60 mV	●	●	●	●	5.2 / 6.2
	-30 to 30 mV	0 to 30 mV	●	●	●	●	5.2 / 6.2

Special function:

Power supply: 20 to 230 V AC/ DC 1.1 / 1.2
 ± 10% AC: 45 to 440 Hz, 1.5 W ~ / ~

Knick VariTrans®

DC/DC-Transmitter

Type P29001P2/01 ES02

No. 81543/0000000

Tamb -25 to +70 °C

www.knick.de

14163 Berlin

Made in Germany  81543



O	Out active	Out passive	S1	S2	Terminals			
					5	6	1	2
								+ / -
O	0to 20mA		●	●	●	●	●	3.1 / 3.2
	0to -20mA		●	●	●	●	●	3.1 / 3.2
	4to 20mA		●	●	●	●	●	3.1 / 3.2
	0to 10 V		●	●	●	●	●	3.3 / 3.2
	0to -10 V		●	●	●	●	●	3.3 / 3.2
		4 to 20mA	●	●	●	●	●	3.1 / 3.2
	-20to 20mA		●	●	●	●	●	3.1 / 3.2
	20to -20mA		●	●	●	●	●	3.1 / 3.2
	4to 20mA		●	●	●	●	●	3.1 / 3.2
		4 to 20mA	●	●	●	●	●	3.1 / 3.2
	-10to 10 V		●	●	●	●	●	3.3 / 3.2
	10to -10 V		●	●	●	●	●	3.3 / 3.2

 OPEN TYPE PROCESS CONTROL EQUIPMENT LISTED E340287

Basic insulation 1000 V CAT III
 Reinforced insulation 600 V CAT II
 Reinforced insulation 300 V CAT III

Special versions (if available), including the values of customer-specific measuring ranges are designated on the corresponding device rating plate.

Function

The input signal is converted into a pulse-width modulated signal and fed into the primary side of a transformer. On the secondary side, the pulse-width signal is converted back into load-independent current or impressed voltage.

3-port isolation with protective separation thanks to reinforced insulation up to 600 V AC/DC according to EN 61140 ensures optimum protection of personnel and equipment as well as undistorted transmission of measuring signals.

Basic insulation is provided up to 1000 V AC/DC.

3-port isolation of the 3 circuits: Inputs, outputs, and power supply

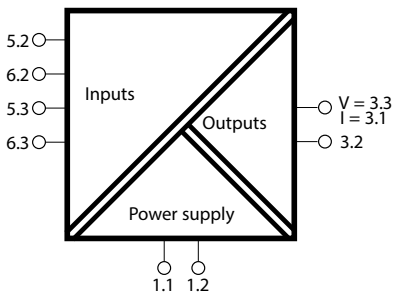

Control Elements (Head Plate)

Switch S1	Function (factory setting in bold)	
S1: 1 ... 4	Input range	
S1: 5 ... 6	Output range	
Switch S2	ON	OFF
S2: 1	Active output	Passive output
S2: 2	Voltage output	Current output
S2: 3	Inverted output	Non-inverted output
S2: 4	Cutoff frequency 10 Hz	Cutoff frequency 10 kHz
S2: 5	Active offset pot.	Calibrated meas. range

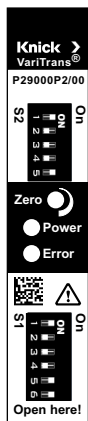

Switch S2

Potentiometer (output offset, max. $\pm 5\%$)

Status LED (green)

Alarm LED (red), flashes once when the device is switched on.

The safety alert symbol means: Read the user manual.

Switch S1

Status Signal

Green LED: Supply voltage provided

Red LED: Error: Check load. If the error cannot be remedied, send in the device for repair.

Note: During switch-on, the red LED flashes briefly to signal that the load monitor is functioning as intended.

Input Ranges

Input ranges P29000P2/0x (factory setting: **range 1**)

No.	Input range		Switch S1: 1 ... 4	Input resistance	Input terminals
	Bipolar	Unipolar			
1	-1000 ... 1000 V	0 ... 1000 V	0000	4 MΩ	5.3 / 6.3
2	-950 ... 950 V	0 ... 950 V	0010	4 MΩ	5.3 / 6.3
3	-900 ... 900 V	0 ... 900 V	0100	4 MΩ	5.3 / 6.3
4	-800 ... 800 V	0 ... 800 V	0110	4 MΩ	5.3 / 6.3
5	-750 ... 750 V	0 ... 750 V	1000	4 MΩ	5.3 / 6.3
6	-700 ... 700 V	0 ... 700 V	1010	4 MΩ	5.3 / 6.3
7	-600 ... 600 V	0 ... 600 V	1100	4 MΩ	5.3 / 6.3
8	-500 ... 500 V	0 ... 500 V	1110	4 MΩ	5.3 / 6.3
9	-450 ... 450 V	0 ... 450 V	0001	2 MΩ	5.2 / 6.2
10	-400 ... 400 V	0 ... 400 V	0011	2 MΩ	5.2 / 6.2
11	-350 ... 350 V	0 ... 350 V	0101	2 MΩ	5.2 / 6.2
12	-300 ... 300 V	0 ... 300 V	0111	2 MΩ	5.2 / 6.2
13	-250 ... 250 V	0 ... 250 V	1001	2 MΩ	5.2 / 6.2
14	-200 ... 200 V	0 ... 200 V	1011	2 MΩ	5.2 / 6.2
15	-150 ... 150 V	0 ... 150 V	1101	2 MΩ	5.2 / 6.2
16	-100 ... 100 V	0 ... 100 V	1111	2 MΩ	5.2 / 6.2

Input Ranges

Input ranges P29001P2/0x (factory setting: range 1)

No.	Input range		Switch S1: 1 ... 4	Input resistance	Input terminals
	Bipolar	Unipolar			
1	-100 ... 100 V	0 ... 100 V	0000	400 kΩ	5.3 / 6.3
2	-80 ... 80 V	0 ... 80 V	0010	400 k Ω	5.3 / 6.3
3	-60 ... 60 V	0 ... 60 V	0100	400 k Ω	5.3 / 6.3
4	-50 ... 50 V	0 ... 50 V	0110	400 k Ω	5.3 / 6.3
5	-30 ... 30 V	0 ... 30 V	1000	400 k Ω	5.3 / 6.3
6	-20 ... 20 V	0 ... 20 V	1010	400 k Ω	5.3 / 6.3
7	-10 ... 10 V	0 ... 10 V	1100	400 k Ω	5.3 / 6.3
8	-5 ... 5 V	0 ... 5 V	1110	400 k Ω	5.3 / 6.3
9	-300 ... 300 mV	0 ... 300 mV	0001	10 k Ω	5.2 / 6.2
10	-200 ... 200 mV	0 ... 200 mV	0011	10 k Ω	5.2 / 6.2
11	-150 ... 150 mV	0 ... 150 mV	0101	10 k Ω	5.2 / 6.2
12	-120 ... 120 mV	0 ... 120 mV	0111	10 k Ω	5.2 / 6.2
13	-100 ... 100 mV	0 ... 100 mV	1001	10 k Ω	5.2 / 6.2
14	-90 ... 90 mV	0 ... 90 mV	1011	10 k Ω	5.2 / 6.2
15	-60 ... 60 mV	0 ... 60 mV	1101	10 k Ω	5.2 / 6.2
16	-30 ... 30 mV	0 ... 30 mV	1111	10 k Ω	5.2 / 6.2

Output Ranges

Output ranges P2900*P2/0x (factory setting: range 1)

No.	Input	Active output	Passive output	S1: 5 ... 6	S2: 1 ... 3	Output terminals
1	Unipolar	0 ... 20 mA		00	100	3.1 / 3.2
2	Unipolar	0 ... -20 mA		00	101	3.1 / 3.2
3	Unipolar	4 ... 20 mA		11	100	3.1 / 3.2
4	Unipolar	0 ... 10 V		01	110	3.3 / 3.2
5	Unipolar	0 ... -10 V		01	111	3.3 / 3.2
6	Unipolar		4 ... 20 mA	11	001	3.1 / 3.2
7	Bipolar	-20 ... 20 mA		00	100	3.1 / 3.2
8	Bipolar	20 ... -20 mA		00	101	3.1 / 3.2
9	Bipolar	4 ... 20 mA		10	100	3.1 / 3.2
10	Bipolar		4 ... 20 mA	10	001	3.1 / 3.2
11	Bipolar	-10 ... 10 V		01	110	3.3 / 3.2
12	Bipolar	10 ... -10 V		01	111	3.3 / 3.2

Mounting and Electrical Connection

▲ WARNING! Shock potential.

For applications with high working voltages, take measures to prevent accidental contact and make sure that there is sufficient distance or insulation between adjacent devices.

The devices must be installed under conditions that ensure pollution degree 2 or better.

The devices are snapped onto DIN rails in accordance with EN 60715 with a width of 35 mm. They are secured on the side using suitable end brackets. See dimension drawing for terminal assignments.

Wire cross-section: 0.2 mm² ... 2.5 mm² (AWG 24-12).

Note: Only use copper cables that are process temperature resistant to at least 75 °C.

Terminal Assignment and Dimensions

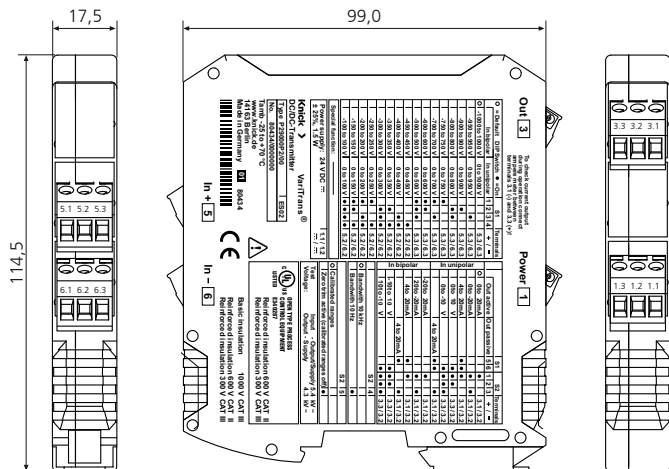

- | | | |
|---|---|---|
| 1.1 Power supply ^{a)} | 1.2 Power supply ^{a)} | 1.3 Not used |
| 3.1 Current output ^{b)}
(passive/active) | 3.2 GND output | 3.3 Output voltage ^{b)} |
| 5.1 Not used | 5.2 Input positive ^{c)} | 5.3 Input positive ^{c)} |
| 6.1 Not used | 6.2 Input negative ^{c)} | 6.3 Input negative ^{c)} |

- a) Polarity is random for supply with direct voltage
- b) The signal outputs are open-circuit proof or short-circuit proof
- c) The input terminal pair (5.2/6.2 or 5.3/6.3) to be used for the relevant selected measuring range is designated on the rating plate and on pages 49, 50 and 54.

Input Wiring Variants

P29000P2/0x: 500 ... 1000 V

P29001P2/0x: 300 mV ... 100 V

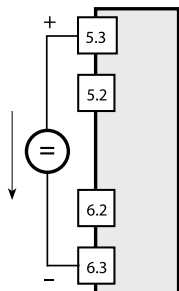

Voltage measurement

P29000P2/0x: 100 ... 500 V

P29001P2/0x: 0 ... 300 mV

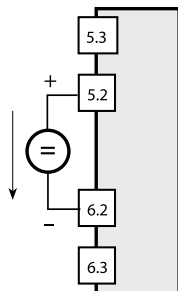

Voltage measurement

P29001P2/0x: 0 ... 300 mV

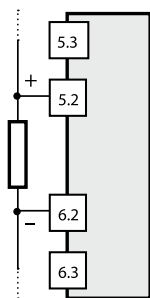

Shunt voltage measurement

Output Wiring Variants

Stromausgang, aktiv

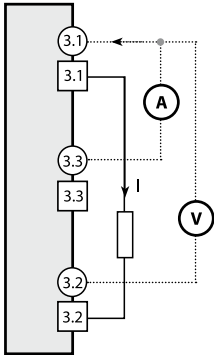

The current measurements presented here are for verifying the output current without opening the output circuit. Terminals 3.1 and 3.3 are the monitor output.



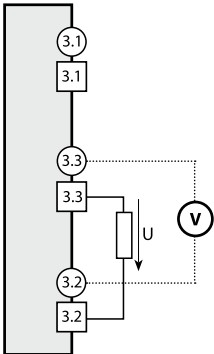

The monitor output can be used for non-disruptive testing of the output current by temporarily connecting a multimeter (to the test jacks), or permanently connecting an isolated display unit.

An open circuit in the monitor output, e.g., because of a broken wire, will not result in impairment or failure of the primary current output.

Voltage output



Legend

-  Test jack
-  Terminal
-  Optional voltage measurement
-  Optional current measurement
(Only DC currents can be correctly measured)

Output Wiring Variants

The device is configured for “passive output” (unipolar/bipolar):

S2-1 V_{Output} Behavior in the case of missing supply voltage

ON	14 V	The externally controlled output current rises to approx. 57 mA, the red LED is glowing slightly.
OFF	24 V	The externally controlled output current rises to approx. 28 mA.



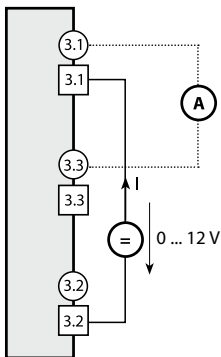

Passive current output
for supply voltage up to 12 V
(S2-1 = ON)

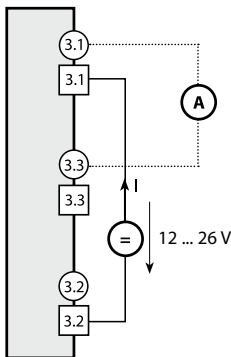

Passive current output
for supply voltages 12 ... 26 V
(S2-1 = OFF)



Legend

-  Test jack
-  Terminal
-  Optional voltage measurement
-  Optional current measurement
(Only DC currents can be correctly measured)

Test Jacks

▲ WARNING! Shock potential.

For applications with high working voltages, take measures to prevent accidental contact and make sure that there is sufficient distance or insulation between adjacent devices. Be sure to use suitable high-voltage test prods with sufficient protection against shock hazards.

The VariTrans® P2900*P2 high voltage transducer has test jacks. Each one is located above the connection wires at the relevant signal terminal (see Figure). It enables function control or signal tracking.

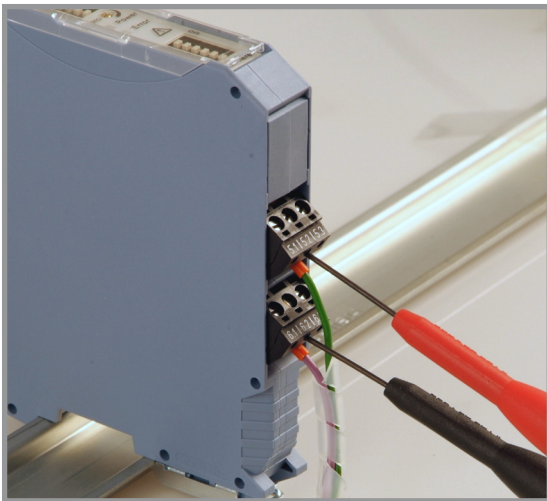

Characteristic Curves

Transmission curve with display of the adjustable offset. The device functions linearly with 100% precision up to 105% drive level.

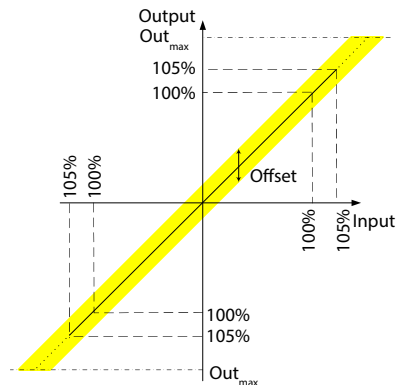

transmission curves with adjustable RangeLimit min. (special variant) and adjustable offset

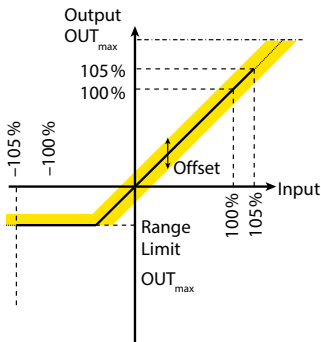

Characteristic Curves

Inverting transmission curves with adjustable RangeLimit max.)
(special variant) and adjustable offset

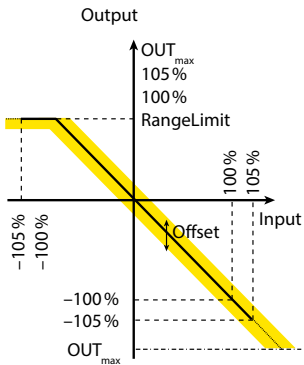

Specifications

Voltage Input Data

Input range	Max. ± 1000 V DC	
Overload capacity (permanent)	0 ... 1 V	Max. ± 30 V
	1 ... 100 V	Max. ± 500 V
	100 ... 500 V	Max. ± 600 V
	500 ... 1000 V	Max. ± 1200 V
Input resistance	0 ... 1 V	Approx. 10 k Ω
	1 ... 100 V	Approx. 400 k Ω
	100 ... 500 V	Approx. 2 M Ω
	500 ... 1000 V	Approx. 4 M Ω
Open circuit detection (special variant)	< 300 μ A	

Specifications

Output Data

Active output	0/4 ... 20 mA or 0 ... 10 V or -20 ... 20 mA or -10 ... 10 V
Passive output	4 ... 20 mA
Max. load (current)	Active ≤ 12 V (600 Ω at 20 mA) Passive 12 ... 26 V
Max. load (voltage)	≤ 10 mA (1 k Ω at 10 V)
Overload capacity with externally applied voltage	± 30 V
Offset	Up to ± 150 % by default
Overdrive region	Current output: > 22 mA (max. 26 mA) Voltage output: < 15 V
Offset adjustment	± 5 %
Ripple	< 10 mVrms
Voltage drop when measuring output current at test jacks 3.1 and 3.3	Max. 150 mV

Transmission Behavior

Gain error	Input ≤ 1 V	≤ 0.1 % meas. val.
	Input > 1 V	≤ 0.2 % meas. val.
Offset	≤ 0.1 % of input range (full scale value)	
Linear control range	-5 % to 105% of input span	
Load error signal	Red LED on front	
Response time t_{99} ^{a)}	< 200 ms or < 200 μ s, switchable	
Cutoff frequency	10 Hz or 10 kHz, switchable	

^{a)} Time after change of input value until reaching an output value of 99% steady state

Specifications

Common-mode rejection ratio Input range ≤ 1 V	CMRR ^{a)} T-CMRR ^{b)}	approx. 150 dB (DC/AC: 50 Hz) approx. 100 dB (1000 V, $t_r = 1 \mu\text{s}$)
Common-mode rejection ratio Input range > 1 V	CMRR ^{a)}	DC: approx. 150 dB AC 50 Hz: approx. 120 dB
Temperature influence ^{c)}	Input ≤ 1 V Input > 1 V	< 50 ppm/K full scale < 80 ppm/K full scale

Power supply

P2900*P2/00	24 V DC ± 25 %
P2900*P2/01	20 ... 230 V AC/DC ± 10 %; AC: 45 Hz to 440 Hz
Power consumption	1.5 W

^{a)} Common-Mode Rejection Ratio:
differential voltage gain : common-mode voltage gain

^{b)} Transient Common-Mode Rejection Ratio:
differential DC gain : common-mode transient peak value gain

^{c)} Reference temperature for TC specifications = 23 °C, average TC

Specifications

Isolation

Galvanic isolation	3-port isolation between input, output, and power supply
Test voltage	5.4 kV AC across input and output / power supply (UL 4.3 kV) 4.3 kV AC across power supply and output
Working voltage (basic insulation) with pollution degree 2 in accordance with IEC 61010-1, EN 61010-1 and UL 61010-1 between all circuits. For applications with contact to users, an additional protective measure is required.	CAT II (OV II): 1000 V AC/DC CAT III (OV III): 1000 V AC/DC (restriction for UL 61010-1: valid only for P2900xP2/01)
Protection against electric shock by reinforced insulation with pollution degree 2 in accordance with IEC 61010-1, EN 61010-1 and UL 61010-1 between all circuits.	CAT II (OV II): 600 V AC/DC CAT III (OV III): 300 V AC/DC (no restriction)

Specifications

Protection against electric shock

▲ WARNING! Shock potential.

For applications with high working voltages, take measures to prevent accidental contact and make sure that there is sufficient distance or insulation between adjacent devices.

For applications above the working voltages of the reinforced insulation and contact to users, an additional protective measure is required to protect users against dangerous voltages (in case of error) on the output signal or the DIN rail bus connector.

Standards and Approvals

EMC

Product standard EN 61326-1

Emitted interference: Class B

Immunity to interference: Industrial applications

USA / Canada, UL

cULus Listed

OPEN TYPE PROCESS CONTROL EQUIPMENT

File: E340287, UL 61010-1, CAN/CSA C22.2 NO. 61010-1

Specifications

Further Data

Ambient temperature	Operation: -25 ... 70 °C (min. start temp.: -40 °C) Operation with passive output: -25 ... 60 °C Transport and storage: -40 ... 85 °C
Design	Modular housing with screw terminals Housing width 17.5 mm
Installation position	Vertical or horizontal
Diameter of the test jacks	2.1 mm
Degree of protection	Housing: IP 40, terminals: IP 20
Ambient conditions	Stationary use, indoor use Relative humidity 5 ... 95 %, no condensation Barometric pressure: 750 ... 1060 hPa Altitude up to 2000 m; The permitted working voltages are reduced at altitudes > 2000 m.
Mounting	With snap-on mounting for 35 mm DIN rail according to EN 60715
Weight	Approx. 120 g

Maintenance, Troubleshooting, Disposal

The high voltage transducer does not require maintenance.

The high voltage transducer must not be opened.

Return of Goods

Do not open the high voltage transducer.

If you have complaints, please contact Knick before returning the high voltage transducer and observe the information about how to return a product on our website:

www.knick.de (select your language) > Service > Repairs

Cleaning

The high voltage transducer may be cleaned with oil-free compressed air.

- Always de-energize the input and power supply of the high voltage transducer before cleaning it.

▲ WARNING! Shock potential.

Observe the safety instructions during all troubleshooting measures, see page 40.

First Steps for Troubleshooting

- Check if all insulated wires are properly connected.
- Check the power supply.
 - When the power LED lights green, power supply is connected.
- Check the input signal.
 - Check if the input signal is actually present.
- Check the output signal.
 - Measure the voltage output, e.g., by connecting a multimeter to the test jacks of the output terminals.
 - Measure the current output via the monitor output, e.g., by connecting a multimeter to the test jacks of the output terminals.

- Check if the current output has been overloaded.
 - Measure the voltage across the current output terminals and measure the output current. Calculate the resulting load. The load must not exceed 600 ohms.
- Check if the voltage output has been overloaded.
 - Measure the current in the voltage output loop and measure the output voltage. The resulting load must not fall below 1000 ohms.
- Check if there is an overdrive of the input signal.
 - Negative overdrive results in a large negative output signal.
 - Positive overdrive results in a large positive output signal.
- Check the output.
 - Measure with a multimeter, for example, to check whether the output signal matches the input signal and the selected measuring range.

Storage

Observe the specifications for storage temperature and relative humidity given in the Specifications chapter.

Disposal

Observe the applicable local or national regulations concerning the disposal of “waste electrical and electronic equipment”.

You can give the high voltage transducer to a certified waste management company for proper disposal.

Product Range

		Order No.					
		P29000P2 /					
Power supply 24 V DC	Standard device	0	_	-	-	-	-
VariPower® broad range power supply (20 ... 230 V AC/DC)	Standard device	1					
Type	Customer-specific			n	n	n	n
		P29001P2 /					
Power supply 24 V DC	Standard device	0	_	-	-	-	-
VariPower® broad range power supply (20 ... 230 V AC/DC)	Standard device	1					
Type	Customer-specific			n	n	n	n

Special Versions

Customer-specific measuring ranges

Up to 192 switchable calibrated ranges can be factory-set to customer requirements.

Shunt break detection

In case of an open voltage input, the output will be at maximum.

RangeLimit

The output value cannot fall below or exceed a defined limit. Limit value and response to out-of-range conditions are factory-set to customer requirements.

All special versions apply to all measuring ranges.

Inputs for current on request. Special versions (if available), including the values of customer-specific measuring ranges are designated on the corresponding device rating plate.

Accessories

	Order No.
IsoPower® A20900 power supply unit 24 V DC, 1 A A20900H4 power supply	A20900H4
DIN rail bus connector: Tapping supply voltage from the A20900H4 (2 units required) and connecting the supply voltage to the high voltage transducer.	ZU0678
Supply terminal, supplying supply voltage to the ZU 0628 DIN rail bus connector Necessary if more than 5 P2900*P* devices will be used. Allows redundant supply from two sources.	ZU0677
DIN rail bus connector: Tapping supply voltage from ZU0677 supply terminal	ZU0628

Accessories



P2900*P*

DIN rail bus connector
3 x ZU0678

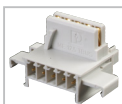

IsoPower® A20900 power supply
A20900H4

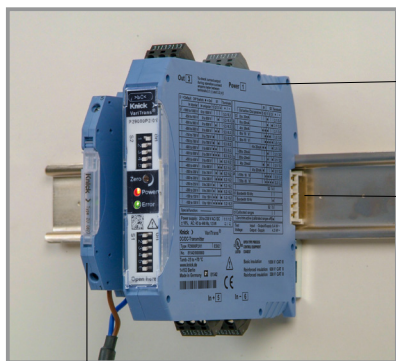

P2900*P*

DIN rail bus connector
1 x ZU0628 + 1 x ZU0678

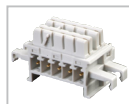

Power terminal block
ZU0677

**Manuel utilisateur
français**

VariTrans P2900*P2

Convertisseurs haute tension

Lire avant l'installation.
Conserver pour une utilisation
ultérieure.



Table des matières

Sécurité.....	76
Symboles et marquages.....	77
Termes et abréviations	78
Utilisation conforme	79
Schéma de principe	80
Plaques signalétiques.....	81
Fonction	83
Éléments de commande (plaque supérieure)	84
Plages d'entrée	85
Plages de sortie	87
Montage et raccordement électrique	88
Correspondance des bornes et dimensions.....	89
Variante de connexion Entrée.....	90
Variante de connexion Sortie.....	91
Prises d'essai.....	93
Caractéristiques	94
Caractéristiques techniques.....	96
Entretien, recherche de défauts, élimination	102
Gamme de produits	104
Accessoires.....	105

Sécurité

▲ AVERTISSEMENT ! Tensions dangereuses en cas de contact.

Dans le cas d'applications avec des tensions de service élevées, observer une distance suffisante ou assurer une isolation avec les appareils voisins et veiller à la protection contre les contacts !

Exigences pour le personnel

L'installation, la mise en service, le fonctionnement, la maintenance et la mise hors service du produit ne doivent être réalisés que par des techniciens autorisés par l'exploitant et formés pour l'utilisation du produit. Selon le domaine d'utilisation du produit, l'exploitant doit s'assurer que le personnel possède une qualification suffisante et conforme aux prescriptions locales et nationales en vigueur.

Pour votre sécurité :

- Conserver ce manuel utilisateur durant toute la période d'utilisation du produit.
- Respecter les consignes de sécurité figurant dans le présent manuel utilisateur et sur le convertisseur haute tension.
- Installer un dispositif de sectionnement bipolaire entre le convertisseur et le réseau.
- N'alimenter le convertisseur haute tension qu'après avoir terminé l'installation et la programmation conformément aux prescriptions.
- Veiller à n'effectuer aucun changement de plage en cours de fonctionnement.

Décharge électrostatique

Veiller à mettre en place une protection contre la décharge électrostatique.

Symboles et marquages

Explication des symboles et marquages sur le boîtier du convertisseur haute tension ou dans le manuel utilisateur :

Symbole Signification



Tension électrique dangereuse en cas de contact avec les composants électriques !



Lire le manuel utilisateur, tenir compte des caractéristiques techniques et respecter les consignes de sécurité !



AVERTISSEMENT ! Signale une situation susceptible d'entraîner la mort ou des blessures graves (irréversibles). Des informations de prévention sont fournies.

Marquage

Symbole

Signification



Marquage CE



Marquage UL

▲ AVERTISSEMENT ! Tensions dangereuses en cas de contact.

Les applications avec un circuit dont la tension de service dépasse l'isolation renforcée spécifiée (voir les pages 81 et 99) et dans lesquelles il est possible qu'un contact s'établisse entre une personne et un autre circuit exigent une mesure de protection supplémentaire, conformément aux prescriptions en vigueur sur les installations électriques (par ex. VDE 0100 et NEC), notamment :

- une isolation supplémentaire,
- une liaison de protection ou un blindage,
- une séparation automatique de l'alimentation électrique,
- un dispositif de limitation du courant ou de la tension.

Termes et abréviations

	Signification
Error	État défaillant
Power	Alimentation
Zero	Ajustage du point zéro du potentiomètre
S1	Commutateur 1
S2	Commutateur 2
HV	Haute tension (<i>High Voltage</i>)
P2900*	P2900* est le terme général pour la gamme de produits.

Utilisation conforme

Le convertisseur haute tension mesure des tensions dans différentes plages de mesure commutables. Il est conçu pour mesurer des tensions et des courants via une résistance de shunt. Le changement de la plage de mesure se fait sous calibrage par switch DIP.

Le signal d'entrée est représenté à la sortie comme un signal normalisé 0/4 ... 20 mA ou 0 ... 10 V ou comme un signal de sortie bipolaire -20 ... 20 mA ou -10 ... 10 V. Le point zéro peut être ajusté à l'aide d'un potentiomètre enclenchable.

L'appareil est doté d'une isolation galvanique 3 ports entre entrée, sortie et alimentation.

Jusqu'à 192 combinaisons de signaux sont possibles dans un même appareil.

Domaines d'application typiques :

- Onduleurs, redresseurs et convertisseurs de fréquence
- Entraînements électriques et générateurs
- Alimentation électrique pour postes de soudage
- Installations solaires et éoliennes
- Accumulateurs d'énergie électriques
- Surveillance de la charge et des états
- Surveillance et commande de systèmes d'alimentation électrique CC

Schéma de principe

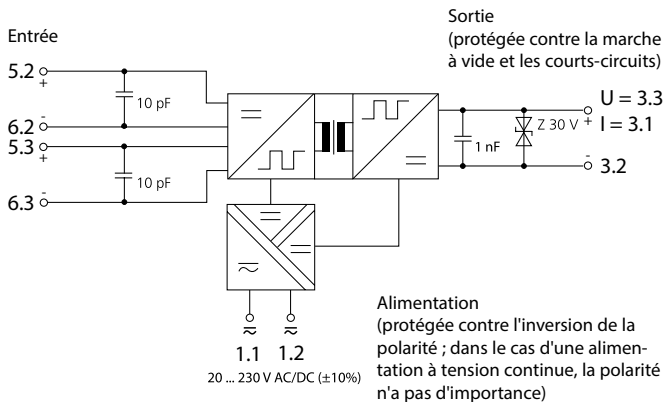

Plaques signalétiques

Variantes

24 V DC

O = Default	DIP Switch	On	S1				Terminals
			In bipolar	In unipolar	1	2	
							+ / -
O	-1000 to 1000 V	0 to 1000 V		•			5,3 / 6,3
	-950 to 950 V	0 to 950 V		•			5,3 / 6,3
	-900 to 900 V	0 to 900 V		•			5,3 / 6,3
	-800 to 800 V	0 to 800 V		•			5,3 / 6,3
	-750 to 750 V	0 to 750 V		•			5,3 / 6,3
	-700 to 700 V	0 to 700 V		•			5,3 / 6,3
	-600 to 600 V	0 to 600 V		•			5,3 / 6,3
	-500 to 500 V	0 to 500 V		•			5,3 / 6,3
	-450 to 450 V	0 to 450 V		•			5,2 / 6,2
	-400 to 400 V	0 to 400 V		•			5,2 / 6,2
	-350 to 350 V	0 to 350 V		•			5,2 / 6,2
	-300 to 300 V	0 to 300 V		•			5,2 / 6,2
	-250 to 250 V	0 to 250 V		•			5,2 / 6,2
	-200 to 200 V	0 to 200 V		•			5,2 / 6,2
	-150 to 150 V	0 to 150 V		•			5,2 / 6,2
	-100 to 100 V	0 to 100 V		•			5,2 / 6,2

Special function:

Power supply: 24 V DC \pm 25%, 1.5 W | 1.1 / 1.2 \pm / \pm

Knick > VariTrans®

DC/DC-Transmitter

Type P29000P2/00 | ES02

No. 80434/0000000

Tamb -25 to +70 °C

www.knick.de

14163 Berlin

Made in Germany 01 80434



	Out active	Out passive	S1				S2	Terminals
			5	6	1	2		
O	0 to 20mA				•			3.1 / 3.2
	0 to -20mA				•			3.1 / 3.2
	4 to 20mA				•	•		3.1 / 3.2
	0 to 10 V				•	•		3.3 / 3.2
	0 to -10 V				•	•		3.3 / 3.2
		4 to 20mA			•	•		3.1 / 3.2
	-20 to 20mA				•			3.1 / 3.2
	20 to -20mA				•			3.1 / 3.2
	4 to 20mA				•	•		3.1 / 3.2
		4 to 20mA			•	•		3.1 / 3.2
	-10 to 10 V				•	•		3.3 / 3.2
	10 to -10 V				•	•		3.3 / 3.2

Bandwidth 10 kHz | S2 | 4 |

Bandwidth 10 Hz | | | |

Calibrated ranges | S2 | 5 |

Zero trim active (calibrated ranges off) | | | |

Test Voltage: Input - Output/Supply 5.4 kV - Output - Supply 4.3 kV -

UL US LISTED OPEN TYPE PROCESS CONTROL EQUIPMENT E340287

Reinforced insulation 600 V CAT II

Reinforced insulation 300 V CAT III

Basic insulation 1000 V CAT III

Reinforced insulation 600 V CAT II

Reinforced insulation 300 V CAT III

O = Default	DIP Switch	On	S1				Terminals
			In bipolar	In unipolar	1	2	
							+ / -
O	-100 to 100 V	0 to 100 V		•			5,3 / 6,3
	-80 to 80 V	0 to 80 V		•			5,3 / 6,3
	-60 to 60 V	0 to 60 V		•			5,3 / 6,3
	-50 to 50 V	0 to 50 V		•			5,3 / 6,3
	-30 to 30 V	0 to 30 V		•			5,3 / 6,3
	-20 to 20 V	0 to 20 V		•			5,3 / 6,3
	-10 to 10 V	0 to 10 V		•			5,3 / 6,3
	-5 to 5 V	0 to 5 V		•			5,3 / 6,3
	-300 to 300 mV	0 to 300 mV		•			5,2 / 6,2
	-200 to 200 mV	0 to 200 mV		•			5,2 / 6,2
	-150 to 150 mV	0 to 150 mV		•			5,2 / 6,2
	-120 to 120 mV	0 to 120 mV		•			5,2 / 6,2
	-100 to 100 mV	0 to 100 mV		•			5,2 / 6,2
	-90 to 90 mV	0 to 90 mV		•			5,2 / 6,2
	-60 to 60 mV	0 to 60 mV		•			5,2 / 6,2
	-30 to 30 mV	0 to 30 mV		•			5,2 / 6,2

Special function:

Power supply: 24 V DC \pm 25%, 1.5 W | 1.1 / 1.2 \pm / \pm

Knick > VariTrans®

DC/DC-Transmitter

Type P29001P2/00 | ES02

No. 80435/0000000

Tamb -25 to +70 °C

www.knick.de

14163 Berlin

Made in Germany 01 80435



	Out active	Out passive	S1				S2	Terminals
			5	6	1	2		
O	0 to 20mA				•			3.1 / 3.2
	0 to -20mA				•			3.1 / 3.2
	4 to 20mA				•	•		3.1 / 3.2
	0 to 10 V				•	•		3.3 / 3.2
	0 to -10 V				•	•		3.3 / 3.2
		4 to 20mA			•	•		3.1 / 3.2
	-20 to 20mA				•			3.1 / 3.2
	20 to -20mA				•			3.1 / 3.2
	4 to 20mA				•	•		3.1 / 3.2
		4 to 20mA			•	•		3.1 / 3.2
	-10 to 10 V				•	•		3.3 / 3.2
	10 to -10 V				•	•		3.3 / 3.2

Bandwidth 10 kHz | S2 | 4 |

Bandwidth 10 Hz | | | |

Calibrated ranges | S2 | 5 |

Zero trim active (calibrated ranges off) | | | |

Test Voltage: Input - Output/Supply 5.4 kV - Output - Supply 4.3 kV -

UL US LISTED OPEN TYPE PROCESS CONTROL EQUIPMENT E340287

Reinforced insulation 600 V CAT II

Reinforced insulation 300 V CAT III

Basic insulation 1000 V CAT III

Reinforced insulation 600 V CAT II

Reinforced insulation 300 V CAT III

Les versions spéciales et les valeurs des plages de mesure programmées spécifiquement pour le client sont précisées le cas échéant sur la plaque signalétique de l'appareil.

Plaques signalétiques

Variantes

20 ... 230 V AC/DC

O = Default		DIP Switch		● = On		S1		Terminals	
In bipolar		In unipolar		1	2	3	4	+ / -	
O	-1000 to 1000 V	0 to 1000 V		●	●	●	●	5,3	6,3
	-950 to 950 V	0 to 950 V		●	●	●	●	5,3	6,3
	-900 to 900 V	0 to 900 V		●	●	●	●	5,3	6,3
	-800 to 800 V	0 to 800 V		●	●	●	●	5,3	6,3
	-750 to 750 V	0 to 750 V		●	●	●	●	5,3	6,3
	-700 to 700 V	0 to 700 V		●	●	●	●	5,3	6,3
	-600 to 600 V	0 to 600 V		●	●	●	●	5,3	6,3
	-500 to 500 V	0 to 500 V		●	●	●	●	5,3	6,3
	-450 to 450 V	0 to 450 V		●	●	●	●	5,2	6,2
	-400 to 400 V	0 to 400 V		●	●	●	●	5,2	6,2
	-350 to 350 V	0 to 350 V		●	●	●	●	5,2	6,2
	-300 to 300 V	0 to 300 V		●	●	●	●	5,2	6,2
	-250 to 250 V	0 to 250 V		●	●	●	●	5,2	6,2
	-200 to 200 V	0 to 200 V		●	●	●	●	5,2	6,2
	-150 to 150 V	0 to 150 V		●	●	●	●	5,2	6,2
	-100 to 100 V	0 to 100 V		●	●	●	●	5,2	6,2

Special function: _____

Power supply: 20 to 230 V AC/ DC 1.1 / 1.2
 ± 10%, AC: 45 to 440 Hz, 1.5 W ~ / ~

Knick VariTrans®

DC/DC-Transmitter

Type P29000P2/01 ES02

No. 81542/0000000

Tamb -25 to +70 °C

www.knick.de

14163 Berlin

Made in Germany  81542



				S1		S2		Terminals	
				5	6	1	2	3	+ / -
O	Out active	Out passive		●	●	●	●	3,1	3,2
	0to 20mA			●	●	●	●	3,1	3,2
	0to -20mA			●	●	●	●	3,1	3,2
	4to 20mA			●	●	●	●	3,1	3,2
	0to 10 V			●	●	●	●	3,3	3,2
	0to -10 V			●	●	●	●	3,3	3,2
		4 to 20mA		●	●	●	●	3,1	3,2
	-20to 20mA			●	●	●	●	3,1	3,2
	20to -20mA			●	●	●	●	3,1	3,2
	4to 20mA			●	●	●	●	3,1	3,2
		4 to 20mA		●	●	●	●	3,1	3,2
	-10to 10 V			●	●	●	●	3,3	3,2
	10to -10 V			●	●	●	●	3,3	3,2
S2 4									
O	Bandwith 10 kHz								
	Bandwith 10 Hz								
S2 5									
O	Calibrated ranges								
	Zero trim active (calibrated ranges off)			●					
Test	Input - Output/Supply	5.4 kV -							
Voltage:	Output - Supply	4.3 kV -							

 OPEN TYPE PROCESS CONTROL EQUIPMENT E340287

Basic insulation 1000 V CAT III

Reinforced insulation 600 V CAT II

Reinforced insulation 300 V CAT III

O = Default		DIP Switch		● = On		S1		Terminals	
In bipolar		In unipolar		1	2	3	4	+ / -	
O	-100 to 100 V	0 to 100 V		●	●	●	●	5,3	6,3
	-80 to 80 V	0 to 80 V		●	●	●	●	5,3	6,3
	-60 to 60 V	0 to 60 V		●	●	●	●	5,3	6,3
	-50 to 50 V	0 to 50 V		●	●	●	●	5,3	6,3
	-30 to 30 V	0 to 30 V		●	●	●	●	5,3	6,3
	-20 to 20 V	0 to 20 V		●	●	●	●	5,3	6,3
	-10 to 10 V	0 to 10 V		●	●	●	●	5,3	6,3
	-5 to 5 V	0 to 5 V		●	●	●	●	5,3	6,3
	-300 to 300 mV	0 to 300 mV		●	●	●	●	5,2	6,2
	-200 to 200 mV	0 to 200 mV		●	●	●	●	5,2	6,2
	-150 to 150 mV	0 to 150 mV		●	●	●	●	5,2	6,2
	-120 to 120 mV	0 to 120 mV		●	●	●	●	5,2	6,2
	-100 to 100 mV	0 to 100 mV		●	●	●	●	5,2	6,2
	-90 to 90 mV	0 to 90 mV		●	●	●	●	5,2	6,2
	-60 to 60 mV	0 to 60 mV		●	●	●	●	5,2	6,2
	-30 to 30 mV	0 to 30 mV		●	●	●	●	5,2	6,2

Special function: _____

Power supply: 20 to 230 V AC/ DC 1.1 / 1.2
 ± 10%, AC: 45 to 440 Hz, 1.5 W ~ / ~

Knick VariTrans®

DC/DC-Transmitter

Type P29001P2/01 ES02

No. 81543/0000000

Tamb -25 to +70 °C

www.knick.de

14163 Berlin

Made in Germany  81543



				S1		S2		Terminals	
				5	6	1	2	3	+ / -
O	Out active	Out passive		●	●	●	●	3,1	3,2
	0to 20mA			●	●	●	●	3,1	3,2
	0to -20mA			●	●	●	●	3,1	3,2
	4to 20mA			●	●	●	●	3,1	3,2
	0to 10 V			●	●	●	●	3,3	3,2
	0to -10 V			●	●	●	●	3,3	3,2
		4 to 20mA		●	●	●	●	3,1	3,2
	-20to 20mA			●	●	●	●	3,1	3,2
	20to -20mA			●	●	●	●	3,1	3,2
	4to 20mA			●	●	●	●	3,1	3,2
		4 to 20mA		●	●	●	●	3,1	3,2
	-10to 10 V			●	●	●	●	3,3	3,2
	10to -10 V			●	●	●	●	3,3	3,2
S2 4									
O	Bandwith 10 kHz								
	Bandwith 10 Hz								
S2 5									
O	Calibrated ranges								
	Zero trim active (calibrated ranges off)			●					
Test	Input - Output/Supply	5.4 kV -							
Voltage:	Output - Supply	4.3 kV -							

 OPEN TYPE PROCESS CONTROL EQUIPMENT E340287

Basic insulation 1000 V CAT III

Reinforced insulation 600 V CAT II

Reinforced insulation 300 V CAT III

Les versions spéciales et les valeurs des plages de mesure programmées spécifiquement pour le client sont précisées le cas échéant sur la plaque signalétique de l'appareil.

Fonction

Le signal d'entrée est converti en signal à modulation de la largeur des impulsions et introduit dans le côté primaire d'un transformateur. Le signal à largeur d'impulsion variable est reconverti dans le côté secondaire en tension ou en courant normalisé(e).

Une isolation 3 ports avec séparation de protection assurée par une isolation renforcée conformément à la norme EN 61140 jusqu'à 600 V AC/DC garantit la protection des personnes et des machines, ainsi que la transmission correcte des signaux de mesure.

Une isolation de base est mise à disposition jusqu'à 1000 V AC/DC.

Séparation 3 ports des trois circuits : entrées, sorties et alimentation

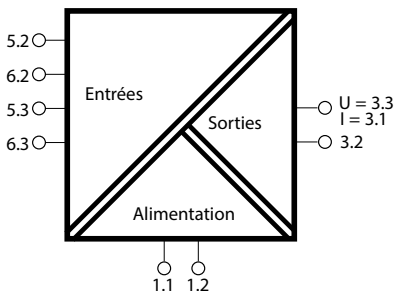

Éléments de commande (plaque supérieure)

Commutateur S1	Fonction (réglage d'origine en gras)	
S1 : 1 ... 4	Plage d'entrée	
S1 : 5 ... 6	Plage de sortie	
Commutateur S2	ON	OFF
S2 : 1	Sortie active	Sortie passive
S2 : 2	Sortie de tension	Sortie de courant
S2 : 3	Sortie inversée	Sortie non inversée
S2 : 4	Fréquence limite 10 Hz	Fréquence limite 10 kHz
S2 : 5	Potent. offset actif	Plage de mes. calibrée

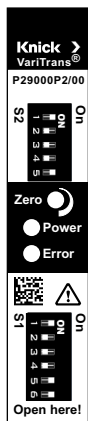

Commutateur S2

Potentiomètre (offset sortie, max. $\pm 5\%$)

LED d'état (verte)

La LED d'alarme (rouge) s'allume brièvement à la mise en marche de l'appareil.

Le symbole d'avertissement signifie : Lire le manuel utilisateur.

Commutateur S1

Signalisation d'état

LED verte : Tension d'alimentation présente

LED rouge : Erreur : Vérifier la charge. S'il est impossible de résoudre l'erreur, renvoyer l'appareil pour réparation.

Remarque : La LED rouge s'allume brièvement à la mise en marche de l'appareil, indiquant que la surveillance de charge fonctionne de manière conforme.

Plages d'entrée

Plages d'entrée P29000P2/0x (réglage d'usine : Plage 1)

N°	Plage d'entrée		Commutateur S1 : 1 ... 4	Résistance d'entrée	Bornes d'entrée
	bipolaire	unipolaire			
1	-1000 ... 1000 V	0 ... 1000 V	0000	4 MΩ	5.3 / 6.3
2	-950 ... 950 V	0 ... 950 V	0010	4 MΩ	5.3 / 6.3
3	-900 ... 900 V	0 ... 900 V	0100	4 MΩ	5.3 / 6.3
4	-800 ... 800 V	0 ... 800 V	0110	4 MΩ	5.3 / 6.3
5	-750 ... 750 V	0 ... 750 V	1000	4 MΩ	5.3 / 6.3
6	-700 ... 700 V	0 ... 700 V	1010	4 MΩ	5.3 / 6.3
7	-600 ... 600 V	0 ... 600 V	1100	4 MΩ	5.3 / 6.3
8	-500 ... 500 V	0 ... 500 V	1110	4 MΩ	5.3 / 6.3
9	-450 ... 450 V	0 ... 450 V	0001	2 MΩ	5.2 / 6.2
10	-400 ... 400 V	0 ... 400 V	0011	2 MΩ	5.2 / 6.2
11	-350 ... 350 V	0 ... 350 V	0101	2 MΩ	5.2 / 6.2
12	-300 ... 300 V	0 ... 300 V	0111	2 MΩ	5.2 / 6.2
13	-250 ... 250 V	0 ... 250 V	1001	2 MΩ	5.2 / 6.2
14	-200 ... 200 V	0 ... 200 V	1011	2 MΩ	5.2 / 6.2
15	-150 ... 150 V	0 ... 150 V	1101	2 MΩ	5.2 / 6.2
16	-100 ... 100 V	0 ... 100 V	1111	2 MΩ	5.2 / 6.2

Plages d'entrée P29001P2/0x (réglage d'usine : Plage 1)

N°	Plage d'entrée		Commutateur S1 : 1 ... 4	Résistance d'entrée	Bornes d'entrée
	bipolaire	unipolaire			
1	-100 ... 100 V	0 ... 100 V	0000	400 kΩ	5.3 / 6.3
2	-80 ... 80 V	0 ... 80 V	0010	400 kΩ	5.3 / 6.3
3	-60 ... 60 V	0 ... 60 V	0100	400 kΩ	5.3 / 6.3
4	-50 ... 50 V	0 ... 50 V	0110	400 kΩ	5.3 / 6.3
5	-30 ... 30 V	0 ... 30 V	1000	400 kΩ	5.3 / 6.3
6	-20 ... 20 V	0 ... 20 V	1010	400 kΩ	5.3 / 6.3
7	-10 ... 10 V	0 ... 10 V	1100	400 kΩ	5.3 / 6.3
8	-5 ... 5 V	0 ... 5 V	1110	400 kΩ	5.3 / 6.3
9	-300 ... 300 mV	0 ... 300 mV	0001	10 kΩ	5.2 / 6.2
10	-200 ... 200 mV	0 ... 200 mV	0011	10 kΩ	5.2 / 6.2
11	-150 ... 150 mV	0 ... 150 mV	0101	10 kΩ	5.2 / 6.2
12	-120 ... 120 mV	0 ... 120 mV	0111	10 kΩ	5.2 / 6.2
13	-100 ... 100 mV	0 ... 100 mV	1001	10 kΩ	5.2 / 6.2
14	-90 ... 90 mV	0 ... 90 mV	1011	10 kΩ	5.2 / 6.2
15	-60 ... 60 mV	0 ... 60 mV	1101	10 kΩ	5.2 / 6.2
16	-30 ... 30 mV	0 ... 30 mV	1111	10 kΩ	5.2 / 6.2

Plages de sortie

Plages de sortie P2900*P2/0x (réglage d'usine : Plage 1)

N°	Entrée	Sortie active	Sortie passive	S1 : 5 ... 6	S2 : 1 ... 3	Bornes de sortie
1	Unipolaire	0 ... 20 mA		00	100	3.1 / 3.2
2	Unipolaire	0 ... -20 mA		00	101	3.1 / 3.2
3	Unipolaire	4 ... 20 mA		11	100	3.1 / 3.2
4	Unipolaire	0 ... 10 V		01	110	3.3 / 3.2
5	Unipolaire	0 ... -10 V		01	111	3.3 / 3.2
6	Unipolaire		4 ... 20 mA	11	001	3.1 / 3.2
7	Bipolaire	-20 ... 20 mA		00	100	3.1 / 3.2
8	Bipolaire	20 ... -20 mA		00	101	3.1 / 3.2
9	Bipolaire	4 ... 20 mA		10	100	3.1 / 3.2
10	Bipolaire		4 ... 20 mA	10	001	3.1 / 3.2
11	Bipolaire	-10 ... 10 V		01	110	3.3 / 3.2
12	Bipolaire	10 ... -10 V		01	111	3.3 / 3.2

Montage et raccordement électrique

▲ AVERTISSEMENT ! Tensions dangereuses en cas de contact.

Dans le cas d'applications avec des tensions de service élevées, observer une distance suffisante ou assurer une isolation avec les appareils voisins et veiller à la protection contre les contacts !

Les appareils doivent être installés dans des conditions garantissant au moins un degré de pollution 2.

Les appareils sont clipsés sur des profilés-supports d'une largeur de 35 mm selon la norme EN 60715 et sont fixés latéralement avec des supports d'extrémité. Pour le brochage, voir le dessin coté.

Section de raccordement : 0,2 mm² ... 2,5 mm² (AWG 24-12).

Remarque : Utiliser uniquement des câbles en cuivre résistant à des températures de process d'au moins 75 °C.

Variantes de connexion Entrée

P29000P2/0x: 500 ... 1000 V

P29001P2/0x: 300 mV ... 100 V

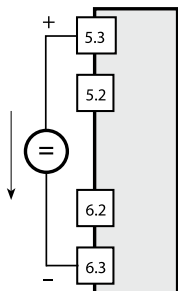

Mesure de la tension

P29000P2/0x: 100 ... 500 V

P29001P2/0x: 0 ... 300 mV

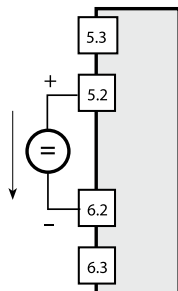

Mesure de la tension

P29001P2/0x: 0 ... 300 mV

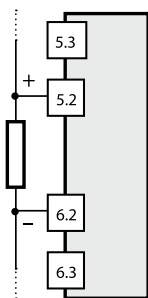

Mesure de la tension de shunt

Variantes de connexion Sortie

Sortie de courant active

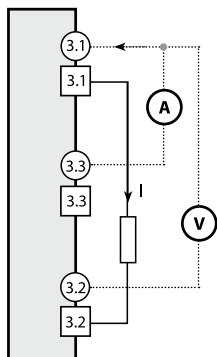

La mesure de courant représentée ici sert à vérifier le courant de sortie sans ouvrir le circuit de sortie. Les bornes 3.1 et 3.3 représentent la sortie Monitor.

Sur la sortie Monitor, le courant de sortie peut être contrôlé temporairement sans interruption avec un multimètre (sur les prises de contrôle) ou un afficheur libre de potentiel peut être raccordé de manière permanente.

Une interruption dans la sortie Monitor, par ex. en raison d'une coupure de câble, n'entraîne aucune perturbation ou panne de la sortie de courant primaire.

Sortie de tension

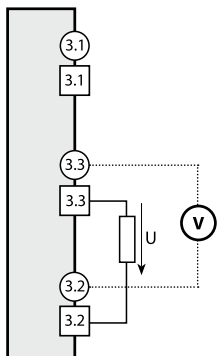

Légende

⊙ 3.1 Prise d'essai

□ 3.1 Borne

⊙ V Mesure de tension en option

⊙ A Mesure de courant en option

(Seuls les courants DC peuvent être mesurés correctement.)

Variantes de connexion Sortie

L'appareil est configuré pour une «sortie passive»
(unipolaire/bipolaire) :

S2-1 U Sortie Comportement en cas d'absence d'alimentation

ON	14 V	Le courant de sortie commandé par une source extérieure augmente jusqu'à env. 57 mA. La LED rouge émet une faible lumière.
OFF	24 V	Le courant de sortie commandé par une source extérieure augmente jusqu'à env. 28 mA.

Sortie de courant passive pour des tensions d'alimentation jusqu'à 12 V (S2-1 = ON)

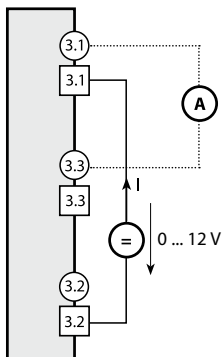

Sortie courant passive pour des tensions d'alimentation 12 V... 26 V (S2-1 = OFF)

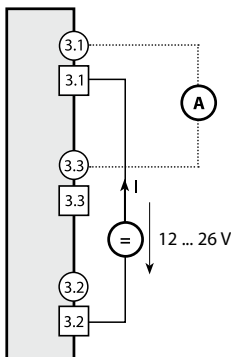

Légende

- Prise d'essai
- Borne
- Mesure de tension en option
- Mesure de courant en option
(Seuls les courants DC peuvent être mesurés correctement.)

Prises d'essai

▲ AVERTISSEMENT ! Tensions dangereuses en cas de contact.

Dans le cas d'applications avec des tensions de service élevées, observer une distance suffisante ou assurer une isolation avec les appareils voisins et veiller à la protection contre les contacts. Utiliser impérativement des pointes pourvues d'un coupe-circuit à haute tension avec une protection contre les contacts !

Le convertisseur haute tension Varitrans® P2900*P2 est pourvu de prises d'essai situées au-dessus des fils sur la borne de signalisation correspondante (voir illustration). Cela permet un contrôle du fonctionnement et un suivi des signaux.

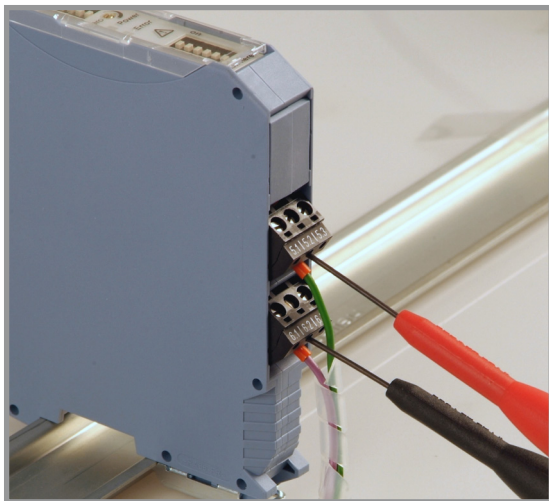

Caractéristiques

Caractéristique de transmission avec représentation de l'offset réglable. Jusqu'à une modulation de 105 %, l'appareil fonctionne de manière linéaire avec une précision optimale.

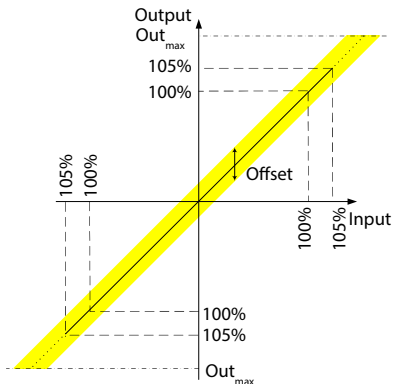

Caractéristique de transmission avec RangeLimit min. réglable (version spéciale) et offset réglable

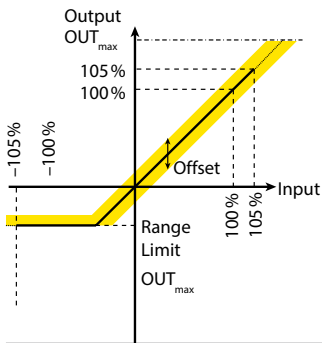

Caractéristiques

Caractéristique de transmission inversée avec RangeLimit max. réglable (version spéciale) et offset réglable

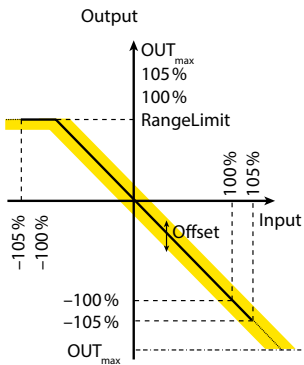

Caractéristiques techniques

Données d'entrée tension

Plage d'entrée	max. \pm 1000 V CC	
Capacité de surcharge (continue)	0 ... 1 V	max. \pm 30 V
	1 ... 100 V	max. \pm 500 V
	100 ... 500 V	max. \pm 600 V
	500 ... 1000 V	max. \pm 1200 V
Résistance d'entrée	0 ... 1 V	env. 10 k Ω
	1 ... 100 V	env. 400 k Ω
	100 ... 500 V	env. 2 M Ω
	500 ... 1000 V	env. 4 M Ω
Détection de rupture de câble (version spéciale)	< 300 μ A	

Caractéristiques techniques

Données de sortie

Sortie active	0/4 ... 20 mA ou 0 ... 10 V ou -20 ... 20 mA ou -10 ... 10 V
Sortie passive	4 ... 20 mA
Charge max. (courant)	Active ≤ 12 V (600 Ω à 20 mA) Passive 12 ... 26 V
Charge max. (tension)	≤ 10 mA (1 k Ω à 10 V)
Capacité de charge avec une tension externe	± 30 V
Décalage	D'origine jusqu'à ± 150 %
Plage de saturation	Sortie de courant : > 22 mA (max. 26 mA) Sortie de tension : < 15 V
Compensation de l'offset	± 5 %
Ondulation résiduelle	< 10 mV eff
Chute de tension lors de la mesure du courant de sortie sur les prises d'essai 3.1 et 3.3	max. 150 mV

Caractéristique de transmission

Erreur de gain	Entrée ≤ 1 V	$\leq 0,1$ % d. m.
	Entrée > 1 V	$\leq 0,2$ % d. m.
Offset	$\leq 0,1$ % de la plage d'entrée (valeur finale)	
Plage de modulation linéaire	-5 % à 105 % de la fourchette de mesure d'entrée	
Signalisation d'une erreur de charge	LED rouge sur la face avant	
Temps de réponse t_{99} ^{a)}	< 200 ms ou < 200 μ s, commutable	
Fréquence limite	10 Hz ou 10 kHz, commutable	

^{a)} Temps après une modification de la valeur d'entrée jusqu'à l'atteinte de la valeur de sortie de 99 % de l'état stable

Caractéristiques techniques

Réjection en mode commun	CMRR ^{a)}	env. 150 dB (DC/AC : 50 Hz)
Plage d'entrée ≤ 1 V	T-CMRR ^{b)}	env. 100 dB (1000 V, t _r = 1 μs)
Réjection en mode commun	CMRR ^{a)}	DC : env. 150 dB
Plage d'entrée > 1 V		AC 50 Hz : env. 120 dB
Influence de la température ^{c)}	Entrée ≤ 1 V	< 50 ppm/K d. f.
	Entrée > 1 V	< 80 ppm/K d. f.

Alimentation

P2900*P2/00	24 V CC +/- 25 %
P2900*P2/01	20 ... 230 V AC/DC ± 10 % ; AC : 45 Hz à 440 Hz
Puissance absorbée	1,5 W

^{a)} Common-Mode Rejection Ratio = Gain en tension différentielle : Gain en tension de mode commun

^{b)} Transient Common-Mode Rejection Ratio = Gain en tension continue différentielle : Gain des valeurs crête transitoires en mode commun

^{c)} Température de référence pour indications CT = 23 °C, CT moyenne

Caractéristiques techniques

Isolation

Isolation galvanique	Isolation 3 ports entre entrée, sortie et alimentation
Tension d'essai	5,4 kV AC entre entrée et sortie / alimentation (UL 4,3 kV) 4,3 kV AC entre alimentation et sortie
Tension de service (isolation de base) pour un degré de pollution 2 selon la norme IEC 61010-1, EN 61010-1 et UL 61010-1 entre tous les circuits. Une mesure de protection supplémentaire est nécessaire pour les applications présentant un contact avec l'utilisateur.	CAT II (OV II) : 1000 V AC/DC CAT III (OV III) : 1000 V AC/DC (restriction pour UL 61010-1 : concerne uniquement P2900xP2/01)
Protection contre les chocs électriques par le biais d'une isolation renforcée pour un degré de pollution 2 selon la norme IEC 61010-1, EN 61010-1 et UL 61010-1 entre tous les circuits.	CAT II (OV II) : 600 V AC/DC CAT III (OV III) : 300 V AC/DC (aucune restriction)

Caractéristiques techniques

Protection contre les chocs électriques

▲ AVERTISSEMENT ! Tensions dangereuses en cas de contact.

Dans le cas d'applications avec des tensions de service élevées, observer une distance suffisante ou assurer une isolation avec les appareils voisins et veiller à la protection contre les contacts.

Dans le cas d'applications au-dessus des tensions de service de l'isolation renforcée et présentant un contact avec l'utilisateur, une mesure de protection supplémentaire est nécessaire pour protéger l'utilisateur des tensions dangereuses (en cas de défaut) sur le signal de sortie ou sur le connecteur-bus sur rail DIN.

Normes et homologations

CEM

Normes famille de produits EN 61326-1
Émission de perturbations : Classe B
Immunité aux perturbations : Industrie

USA / Canada, UL

cULus Listed
OPEN TYPE PROCESS CONTROL
EQUIPMENT
File: E340287, UL 61010-1, CAN/CSA
C22.2 NO. 61010-1

Caractéristiques techniques

Autres caractéristiques

Température ambiante	Service : -25 ... 70 °C (temp. de départ min. : -40 °C)
	Service avec sortie passive : -25 ... 60 °C
	Transport et stockage : -40 ... 85 °C
Modèle	Boîtier série avec bornes à vis Largeur du boîtier 17,5 mm
Position de montage	Vertical ou horizontal
Diamètre des prises d'essai	2,1 mm
Protection	Boîtier IP 40, bornes IP 20
Conditions ambiantes	Utilisation stationnaire, en intérieur Humidité relative : 5 ... 95 %, sans condensation Pression atmosphérique : 750 ... 1060 hPa Jusqu'à une altitude de 2000 m ; à des hauteurs >2000 m, les tensions de service autorisées diminuent
Fixation	avec fixation à déclic sur profilé-support 35 mm suivant EN 60715
Poids	env. 120 g

Entretien, recherche de défauts, élimination

Le convertisseur haute tension ne nécessite aucun entretien.
Ne pas ouvrir le convertisseur haute tension.

Retour de marchandises

Ne pas ouvrir le convertisseur haute tension !

En cas de réclamation, prenez contact avec la société Knick avant de renvoyer le convertisseur haute tension et respectez la procédure de retour sur le site Internet :

www.knick.de > Service > Réparations

Nettoyage

Le convertisseur haute tension peut être nettoyé avec de l'air comprimé sans huile.

- Avant le nettoyage, mettre hors tension l'entrée et l'alimentation du convertisseur haute tension !

▲ AVERTISSEMENT ! Tensions dangereuses en cas de contact.

Respecter les consignes de sécurité lors des opérations de recherche de défauts, voir la page 76.

Premières mesures pour la recherche de défauts

- Contrôler le raccordement correct de tous les câbles isolés.
- Contrôler l'alimentation auxiliaire.
 - Quand la LED Power est allumée, le convertisseur est alimenté.
- Contrôler le signal d'entrée
 - Contrôler la présence réelle du signal d'entrée.
- Contrôler le signal de sortie
 - Mesurer la sortie de tension, par ex. avec un multimètre sur les prises d'essai des bornes de sortie.
 - Mesurer la sortie de courant via la sortie Monitor, par ex. avec un multimètre sur les prises d'essai des bornes de sortie.

- Contrôler une éventuelle surcharge de la sortie de courant.
 - Mesurer la tension sur les bornes de sortie de courant ainsi que le courant de sortie et en déduire la charge. La charge ne doit pas dépasser 600 ohms.
- Contrôler une éventuelle surcharge de la sortie de tension.
 - Mesurer le courant dans la boucle de sortie de tension ainsi que la tension de sortie. La résistance de charge résultante ne doit pas dépasser 1000 ohms.
- Contrôler la saturation de l'entrée.
 - En cas de saturation négative, un signal négatif important est envoyé en sortie.
 - En cas de saturation positive, un signal positif important est envoyé en sortie.
- Contrôler la sortie.
 - Réaliser une mesure, par ex. avec un multimètre, pour vérifier si le signal de sortie concorde avec le signal d'entrée et la plage de mesure sélectionnée.

Stockage

Respecter les indications relatives aux températures de stockage et au taux d'humidité relative dans les caractéristiques techniques.

Élimination

Respecter les règlements nationaux pour l'élimination des appareils électriques et électroniques !

Le convertisseur haute tension peut être déposé chez une entreprise de collecte certifiée afin de garantir une élimination conforme aux prescriptions.

Gamme de produits

	Référence						
	P29000P2 /	0	-	-	-	-	-
Alimentation 24 V CC	Appareil standard	0					
Alimentation avec bloc d'alimentation à plage élargie VariPower® (20 ... 230 V AC/DC)	Appareil standard	1					
Version	Spécification du client			n	n	n	n
	P29001P2 /	0	-	-	-	-	-
Alimentation 24 V CC	Appareil standard	0					
Alimentation avec bloc d'alimentation à plage élargie VariPower® (20 ... 230 V AC/DC)	Appareil standard	1					
Version	Spécification du client			n	n	n	n

Versions spéciales

Plages de mesure spécifiques au client Il est possible de paramétrer jusqu'à 192 plages calibrées commutables à l'usine en fonction des exigences spécifiques du client.

Détection de rupture de shunt Si une entrée de tension est ouverte, la sortie passe en max.

RangeLimit (limites de plage) La valeur de sortie ne peut pas dépasser une limite définie, dans un sens ou dans l'autre. La valeur limite et le comportement en cas de dépassement de la valeur limite dans un sens ou dans l'autre sont paramétrés à l'usine en fonction des exigences du client.

Les versions spéciales sont toujours valables pour toutes les plages de mesure.

Entrées pour le courant sur demande. Les versions spéciales et les valeurs des plages de mesure programmées spécifiquement pour le client sont précisées le cas échéant sur la plaque signalétique de l'appareil.

Accessoires

	Référence
IsoPower® A20900 alimentation 24 V DC, 1 A Alimentation A20900H4	A20900H4
Connecteur-bus sur rail DIN : Prise de tension d'alimentation sur A20900H4 (2 unités nécessaires) et pour l'injection de la tension d'alimentation dans le convertisseur haute tension.	ZU0678
Bloc de jonction d'alimentation, pour alimenter les connecteurs-bus sur rail DIN ZU0628 en tension d'alimentation Nécessaire si plus de 5 convertisseurs P2900*P* doivent être utilisés. Alimentation redondante possible avec deux sources.	ZU0677
Connecteur-bus sur rail DIN : Prise de tension d'alimentation sur le bloc de jonction d'alimentation ZU0677	ZU0628

Accessoires



P2900*P*

Connecteur-bus sur rail
DIN : 3 x ZU0678

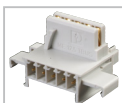

Alimentation IsoPower® A20900
A20900H4

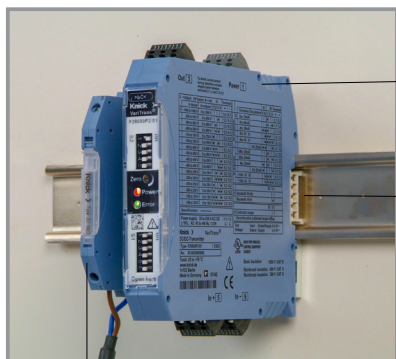

P2900*P*

Connecteur-bus sur rail DIN
1 x ZU0628 + 1 x ZU0678

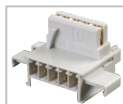
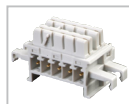

Bloc de jonction d'alimentation
ZU0677



Knick
Elektronische Messgeräte
GmbH & Co. KG

Beuckestraße 22 • 14163 Berlin
Germany
Phone: +49 30 80191-0
Fax: +49 30 80191-200
info@knick.de
www.knick.de

DE Copyright 2019 • Änderungen vorbehalten
Version: 3.0
Dieses Dokument wurde zuletzt aktualisiert am 29.05.2019
Aktuelle Dokumente finden Sie zum Herunterladen auf unserer Website unter dem entsprechenden Produkt.

EN Copyright 2019 • Subject to change
Version: 3.0
This document was last updated on May 29, 2019
The latest documents are available for download on our website under the corresponding product description.

FR Copyright 2019 • Sous réserve de modifications
Version: 3.0
Dernière mise à jour de ce manuel utilisateur le 29/05/2019
Les manuels utilisateur actuels peuvent être téléchargés sur le site, sous le produit correspondant.



086100

TA-251.200-KNX03