

User Manual
English

Stratos Evo A402 Conductivity Measurement

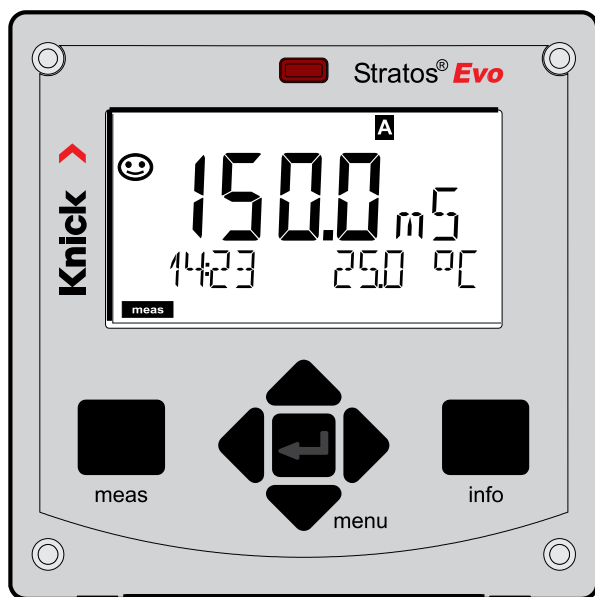

Basics	5
Documents Supplied	6
Introduction	7
Overview of the Stratos Evo	12
Modular Concept.....	16
Terminal Plate and Rating Plates	17
Installation	18
Power Supply, Signal Assignments	19
Digital Sensors: Memosens.....	20
Changing the Measuring Function	23
Inserting a Module	23
Cond Module.....	24
Cond Wiring Examples	25
Condi Module.....	33
Cable Preparation SE 655 / SE 656	34
Condi Wiring Examples	35
Dual-Conductivity Module	40
Cond-Cond Wiring Examples	41
Operation	44
The Keys and Their Functions	45
The Display	46
Display in Measuring Mode	47
Color-Coded User Interface	48
Selecting the Mode / Entering Values.....	49
Operating Modes	50
Overview of Configuration	54
Switching Parameter Sets A/B	55
Signaling Parameter Set.....	56
Connecting a Memosens Sensor	57
Configuring a Cond Sensor	59
USP Function.....	62

Configuring a Condi Sensor	71
Device Type: Cond-Cond	80
Entries for Calculating the Consumption of the Ion Exchanger	84
Configuration: Overview Tables	86
Configuring the Current Output	92
Temperature Compensation	102
Configuring the CONTROL Input	104
Configuring the Alarm	108
Configuring the Relay Contacts	112
Protective Wiring of Relay Contacts	118
PID Controller (not with Cond-Cond)	121
Configuring the WASH Contact	128
Configuring the Time/Date	130
Calibration with Calibration Solution	134
Product Calibration	136
Calibrating Toroidal Sensors	139
Calibration by Input of Cell Factor	140
Zero Calibration	141
Measurement	143
Diagnostics	147
Service	152
Operating Error!	156
Error Messages	158
Sensocheck and Sensoface	162
Operating States	163
Product Range	164
Specifications	166
Calibration Solutions	176
Concentration Measurement	178
Concentration Curves	179
Index	185

Subject to change without notice

Return of Products Under Warranty

Please contact our Service Team before returning a defective device.

Ship the cleaned device to the address you have been given.

If the device has been in contact with process fluids, it must be decontaminated/ disinfected before shipment. In that case, please attach a corresponding certificate, for the health and safety of our service personnel.

Disposal

Please observe the applicable local or national regulations concerning the disposal of “waste electrical and electronic equipment”.

About This Manual:

This manual is intended as a reference guide to your device –

You don't have to read the book from front to back.

Take a look at the **Table of Contents** or the **Index** to find the function you are interested in. Each topic is explained on a double-page spread with step-by-step instructions on how to configure the desired function. Clearly legible page numbers and headlines help you to quickly find the information:

Left page:

How do I get to the function

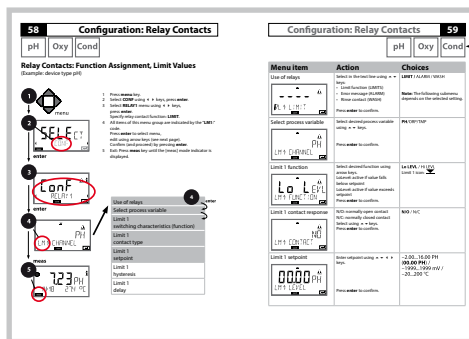

← Parameter concerned

Right page:

Which settings are provided for this function

Safety Instructions

In official EU languages and others

Quickstart Guides

Installation and first steps:

- Operation
- Menu structure
- Calibration
- Error messages and recommended actions

Specific Test Report

Electronic Documentation

Manuals + Software

Ex Devices:

Control Drawings

EU Declarations of Conformity

Up-to date documentation available on our website:



Stratos Evo is a 4-wire analyzer for process analysis applications.

The analyzer comes as basic device for measurement with digital sensors

(Memosens, optical oxygen measurement, inductive conductivity measurement).

All measuring functions are stored in an internal memory. You select a measuring function to configure the analyzer for a specific measuring task. Additional measuring modules can be connected to allow measurement with analog sensors.

The Model A402B allows applications in hazardous-area Zone 2.

Current is provided through a universal power supply 80 ... 230 V AC, 45 ... 65 Hz / 24 ... 60 V DC. The analyzer provides two 0 (4) ... 20 mA current outputs for transmission of measured value and temperature, for example. Four floating relay contacts are available for free configuration. A PID controller and a time-controlled cleaning function can be configured. Two parameter sets are provided. You can externally switch between them via the Control input, for example. The HOLD input allows setting the HOLD mode from the outside. The analyzer also provides power supply and allows signal processing for additional transmitters, e.g., for flow monitoring.

You can select one of the following measuring functions:

- pH
- ORP
- Oxygen
- Oxygen, optical
- Conductivity measurement (conductive/inductive)
- Dual conductivity measurement using two analog sensors
- Dual measurement of pH/pH and pH/Oxy using two Memosens sensors

Enclosure and mounting possibilities

- The sturdy molded enclosure is rated IP 67/NEMA 4X outdoor.

Material of front unit: PBT, rear unit: PC.

Dimensions: H 148 mm, W 148 mm, D 117 mm.

It is provided with knockouts for:

- panel mounting (138 mm x 138 mm cutout to DIN 43700)
- wall mounting (with sealing plugs to seal the enclosure)
- post/pipe mounting (dia. 40 ... 60 mm, □ 30 ... 45 mm)

Connection of sensors, cable glands

For connecting the cables, the enclosure provides

- 3 knockouts for cable glands M20x1.5
- 2 knockouts for NPT 1/2" or rigid metallic conduit

Display

Plain-text messages in a large, backlit LC display allow intuitive operation. You can specify which values are to be displayed in standard measuring mode (“Main Display”).

Color-coded user interface

The colored display backlighting signals different operating states (e.g., alarm: red, HOLD mode: orange).

Diagnostics functions

The “Sensocheck” automatic sensor monitoring and the “Sensoface” function for clear indication of the sensor condition provide excellent diagnostics.

Data Logger

The internal logbook (additional function, TAN SW-A002) can handle up to 100 entries – up to 200 with AuditTrail (additional function, TAN SW-A003).

2 parameter sets A/B

The device provides two parameter sets which can be switched manually or via a control input for different process adaptations or different process conditions. For an overview of parameter sets (original for copy), refer to the CD or www.knick.de.

Password protection

Password protection (passcode) for granting access rights during operation can be configured.

Control inputs

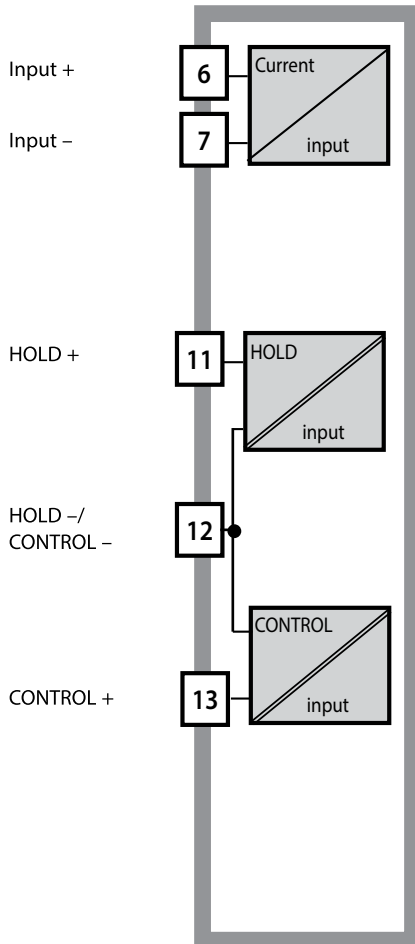

I input

The analog (0) 4 ... 20 mA current input can be used for external pressure or temperature compensation. (TAN required.)

HOLD

(floating digital control input)

The HOLD input can be used for external activation of the HOLD mode.

CONTROL

(floating digital control input)

The CONTROL input can be used either for parameter set selection (A/B) or for flow monitoring. The "Wash" contact can be used for indicating the active parameter set.

Power supply

Current is provided through a universal power supply 80 ... 230 V AC, 45 ... 65 Hz / 24 ... 60 V DC.

Options

Additional functions can be activated by entering a TAN.

Signal outputs

The analyzer provides two 0 (4) ... 20 mA current outputs for transmission of measured value and temperature, for example.

Relay contacts

Four floating relay contacts are available.

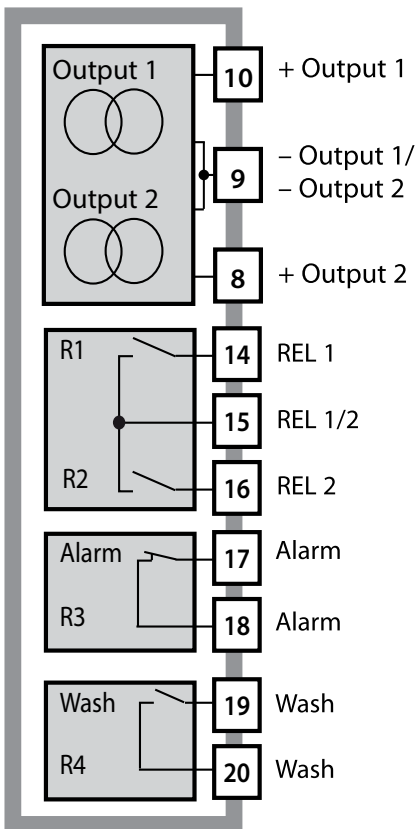

Current outputs

The floating current outputs (0) 4 ... 20 mA are used for transmitting measured values. An output filter can be programmed, the fault current value can be specified.

Relay contacts

2 relay contacts for limit values. Adjustable for the selected process variable: hysteresis, switching behavior (MIN/MAX limit), contact type (N/O, N/C) and delay.

Alarm

An alarm can be generated by Sensocheck, flow monitoring or current failure.

Wash (cleaning function)

This contact can be used for controlling a rinsing probe or for indicating the active parameter set.

PID controller

Configurable as pulse length or pulse frequency controller.

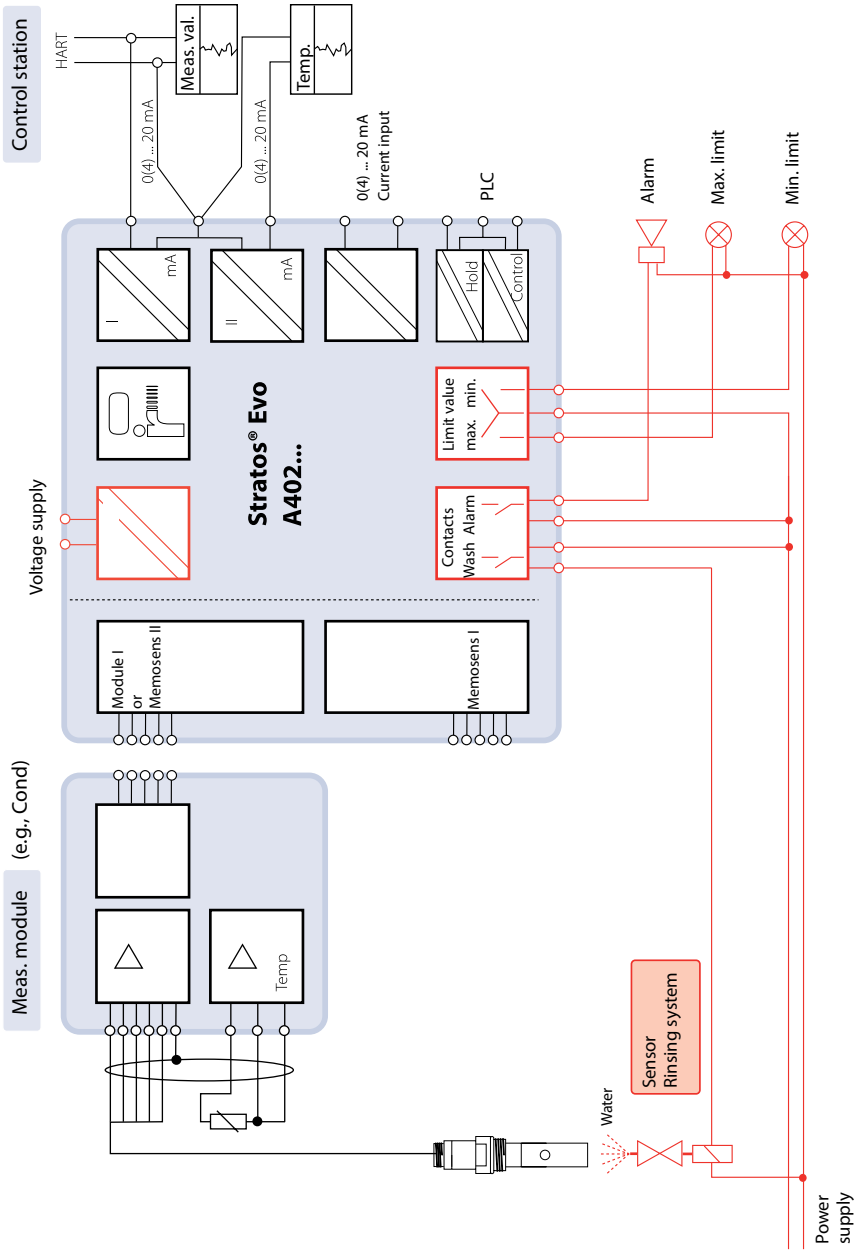

Package Contents

Check the shipment for transport damage and completeness.

The package should contain:

Front unit, rear unit, bag containing small parts

Specific test report

Documentation

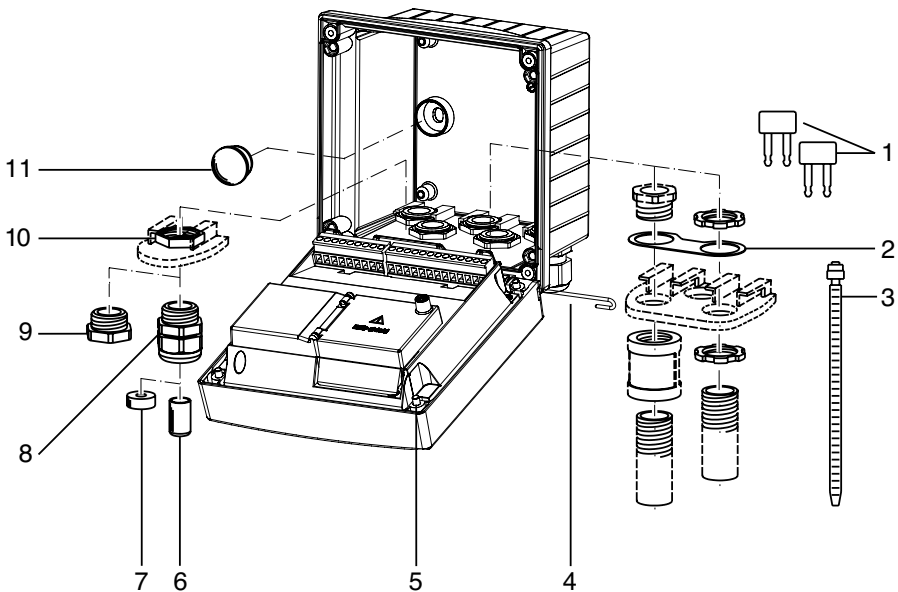
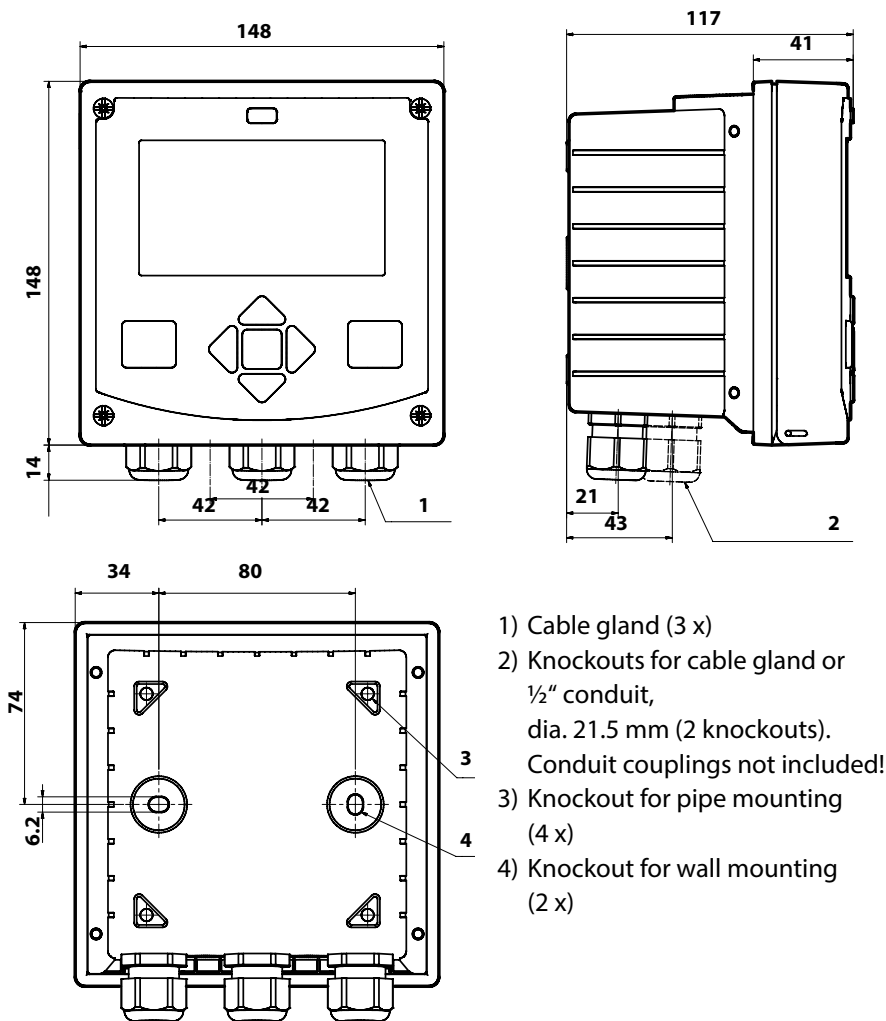

Fig.: Assembling the enclosure

- | | |
|--|--|
| 1) Jumper (3 x) | 6) Sealing insert (1 x) |
| 2) Washer (1 x), for conduit mounting:
Place washer between enclosure and nut | 7) Rubber reducer (1 x) |
| 3) Cable tie (3 x) | 8) Cable gland, M20x1.5 (3 x) |
| 4) Hinge pin (1 x), insertable from either side | 9) Filler plug (3 x) |
| 5) Enclosure screw (4 x) | 10) Hexagon nut (5 x) |
| | 11) Sealing plug (2 x), for sealing in case of wall mounting |

Mounting Plan, Dimensions



- 1) Cable gland (3 x)
- 2) Knockouts for cable gland or ½" conduit, dia. 21.5 mm (2 knockouts). Conduit couplings not included!
- 3) Knockout for pipe mounting (4 x)
- 4) Knockout for wall mounting (2 x)

All dimensions in mm

Mounting Accessories

Pipe-mount kit, accessory ZU 0274

Protective hood for wall and pipe mounting, accessory ZU 0737

Panel-mount kit, accessory ZU 0738

Pipe Mounting, Protective Hood

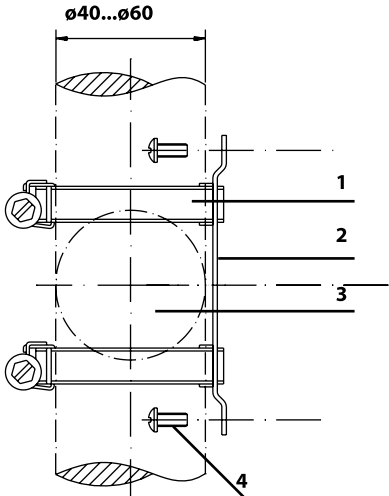

- 1) Hose clamp with worm gear drive to DIN 3017 (2 x)
- 2) Pipe-mount plate (1 x)
- 3) For vertical or horizontal posts or pipes
- 4) Self-tapping screw (4 x)

Fig.: Pipe-mount kit, accessory ZU 0274

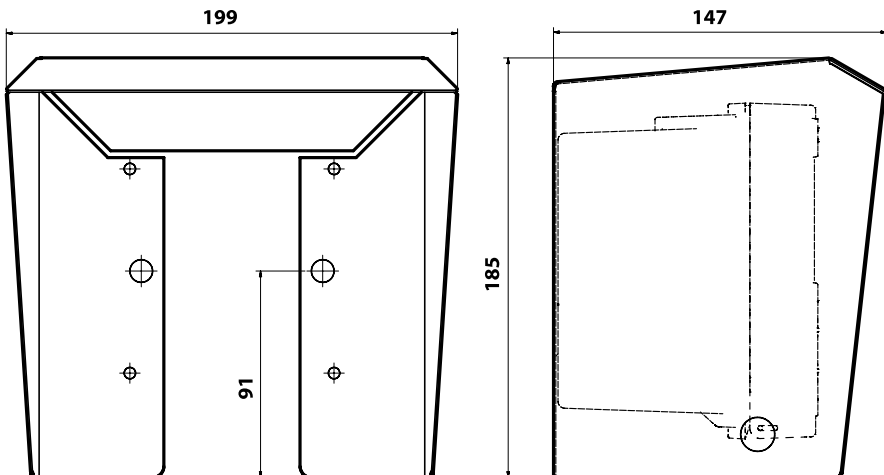
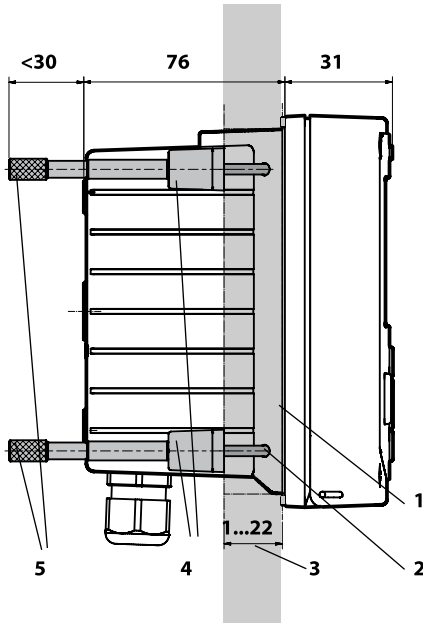

Fig.: Protective hood for wall and pipe mounting, accessory ZU 0737

Panel Mounting



- 1) Circumferential sealing (1 x)
- 2) Screws (4 x)
- 3) Position of control panel
- 4) Span piece (4 x)
- 5) Threaded sleeve (4 x)

Cutout

138 x 138 mm (DIN 43700)

Fig.: Panel-mount kit, accessory ZU 0738

All dimensions in mm

For connection of analog sensors:
Insert interchangeable module (measuring module)

Memosens

+3 V
RS 485 A
RS 485 B
GND/Shield

PWR out
Power output
3.1/12/15/24 V 1 W

Input +

Input -

HOLD +

HOLD -/
CONTROL -

CONTROL +

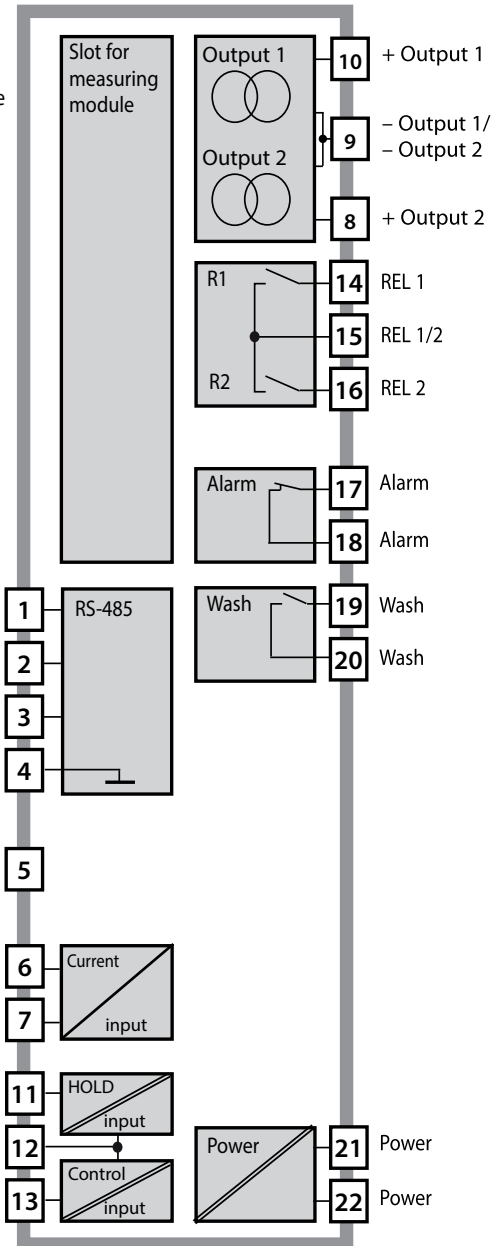



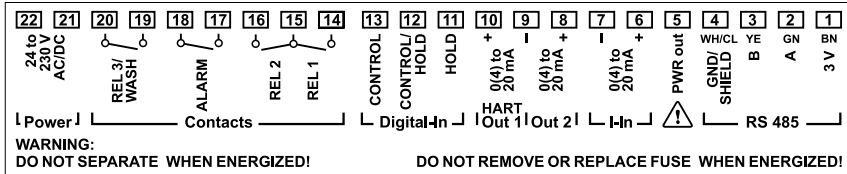

Terminal Assignments

The terminals are suitable for single or stranded wires up to 2.5 mm² (AWG 14).



A402N Rating Plate

Knick >	
A4*2N	
No. 84192 / 0000000 / 1233	
-20 ≤ T _a ≤ +55 °C	Power
EnclosureType4X	80 (-15%) to 230 (+10%) V AC, 45 to 65 Hz, < 15 VA
	24 (-15%) to 60 (+10%) V DC, ≈ 10 W
D-14163Berlin	Made in Germany
  	

Installation Instructions

- Installation of the device must be carried out by trained experts in accordance with this user manual and as per applicable local and national codes.
- Be sure to observe the technical specifications and input ratings during installation!
- Be sure not to notch the conductor when stripping the insulation!
- Before connecting the device to the power supply, make sure that its voltage lies within the range 80 to 230 V AC/DC or 24 to 60 V DC.
- A signal current supplied to the current input must be galvanically isolated. If not, connect an isolator module.
- All parameters must be set by a system administrator prior to commissioning.

Terminals

suitable for single or stranded wires up to 2.5 mm² (AWG 14)

Application in Hazardous Locations



When using the device in a hazardous location, observe the specifications of the Control Drawing.

Power Supply

Connect the power supply for Stratos Evo to terminals 21 and 22
(24 ... 230 V AC, 45 ... 65 Hz / 24 ... 80 V DC)

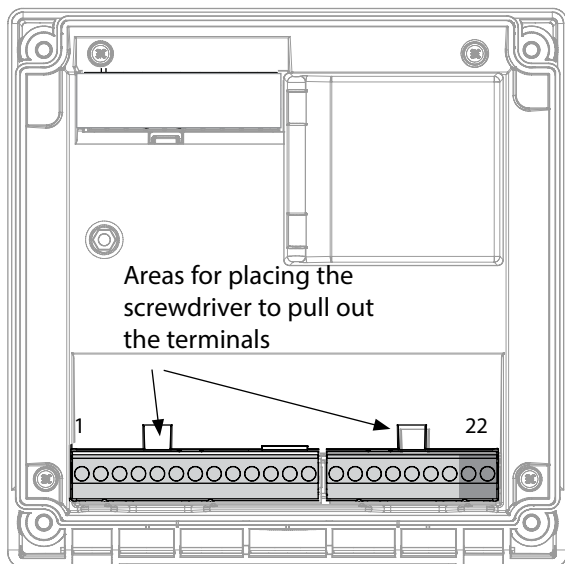

Figure:
Terminals, device opened,
back of front unit

Connecting the Memosens Sensor

Connect the Memosens sensor to the RS-485 interface of the device. Then select the measuring function. (When you change to another sensor type, you can change the measuring function in the "Service" menu.)

When you select the sensor in the Configuration menu, the calibration data are read from the sensor. They can later be modified by calibration.

Terminal assignments

Memosens connection

1 (BN)	+3 V	Brown
2 (GN)	RS 485 A	Green
3 (YE)	RS 485 B	Yellow
4 (WH)	GND/shield	White / Shield

5 Power Out

6 + input

7 - input

Current outputs OUT1, OUT2

8 + Out 2

9 - Out 2 / - Out 1 / HART

10 + Out 1 / HART

11 HOLD

12 HOLD / Control

13 Control

Relay contacts REL1, REL2

14 REL 1

15 REL 1/2

16 REL 2

17 alarm

18 alarm

19 wash

20 wash

Power supply

21 power

22 power

Start-Up

When you start up the analyzer for the first time, you will be prompted to select the desired measurement procedure (a connected Memosens sensor will not be identified automatically).

Changing the Measuring Function

In the "Service" menu you can select another measuring function at any time.

Calibration and Maintenance in the Lab

The "MemoSuite" software allows calibrating Memosens sensors under reproducible conditions at a PC in the lab. The sensor parameters are registered in a database. Documenting and archiving meet the demands of FDA CFR 21 Part 11. Detailed reports can be output as csv export for Excel. MemoSuite is available as accessory and comes in the versions "Basic" and "Advanced": www.knick.de.

Settings and specifications

Connected sensor: sensor type, manufacturer, order code and serial number

Function selection:
The selected function is highlighted.

Connected sensor: sensor type, manufacturer, order code and serial number, measuring point and tag number

Last adjustment

You can magnify a measured-value display at a click of the mouse.

The screenshot displays the MemoSuite Advanced software interface. The top navigation bar includes 'StartCenter', 'Calibration', 'Table View', 'History', 'Statistics', and 'pH Buffers'. The 'pH Buffers' option is highlighted. The main area is divided into three sections: 'Measured values' (showing Conductivity at 1.010 mS/cm, Resistance at 1.00 kΩ, and Temperature at 25 °C), 'Sensor data' (showing Conductivity sensor type, Knick manufacturer, SE630-MS order code, 11003 serial number, and measuring point/tag number 7), and 'Adjustment data' (showing a date of 4/27/2015 20:09:12 and a cell constant of 1.01 1/cm). A red circle highlights the '1.010 mS/cm' value in the 'Measured values' section, and a callout box shows a magnified view of this value.

Measured values	Sensor data	Adjustment data
Conductivity: 1.010 mS/cm	Sensor type: Conductivity	Date: 4/27/2015 20:09:12
Resistance: 1.00 kΩ	Manufacturer: Knick	Cell constant: 1.01 1/cm
Temperature: 25 °C	Order code: SE630-MS	
	Serial number: 11003	
	Measuring point: 7	
	Tag number: 7	

Standard connection (sensor A)

1	Brown	+3 V
2	Green	RS 485 A
3	Yellow	RS 485 B
4	White/Transp.	GND/shield

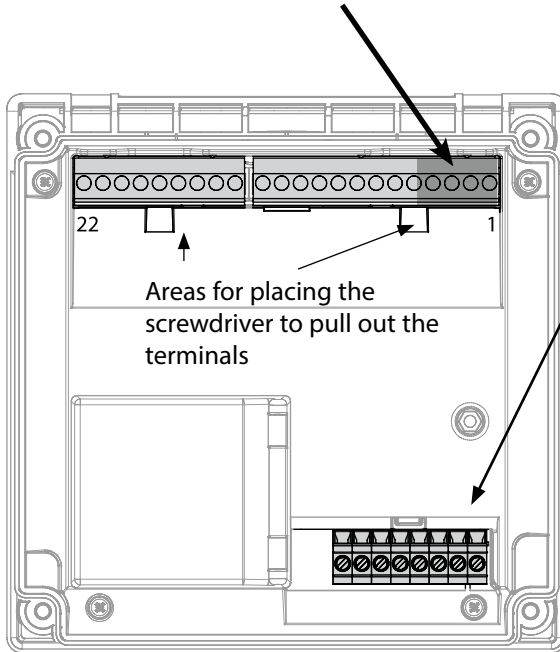

For dual devices

Connection of sensor B

A	Brown	+3 V
B	Green	RS 485 A
C	Yellow	RS 485 B
D	White	GND
E	Transp.	SHIELD

Memosens Cable

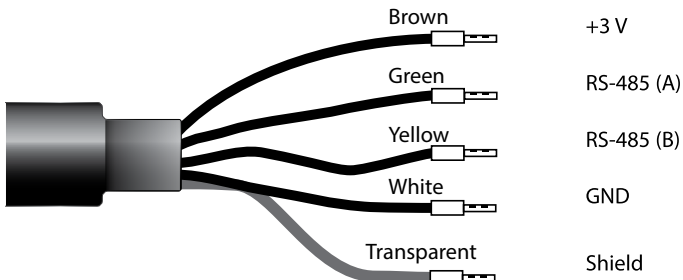

Connecting cable for non-contact inductive digital transmission of measured signals (Memosens).

By providing perfect galvanic isolation between sensor and analyzer/transmitter, the Memosens cable prevents measurement interferences. Any effects of humidity and corrosion are prevented.

Specifications

Material	TPE
Cable diameter	6.3 mm
Length	up to 100 m
Process temperature	-20 °C ... +135 °C / -4 ... +275 °F
Ingress protection	IP 68

Order Codes

	Cable type	Cable length	Order number
Memosens	Ferrules	3 m	CA/MS-003NAA
		5 m	CA/MS-005NAA
		10 m	CA/MS-010NAA
		20 m	CA/MS-020NAA
	M12 plug, 8-pin	3 m	CA/MS-003NCA
		5 m	CA/MS-005NCA
Memosens Ex*	Ferrules	3 m	CA/MS-003XAA
		5 m	CA/MS-005XAA
		10 m	CA/MS-010XAA
		20 m	CA/MS-020XAA
	M12 plug, 8-pin	3 m	CA/MS-003XCA
		5 m	CA/MS-005XCA

Other cable lengths or cable types are available on request.

* Ex-certified ATEX II 1G Ex ia IIC T3/T4/T6 Ga

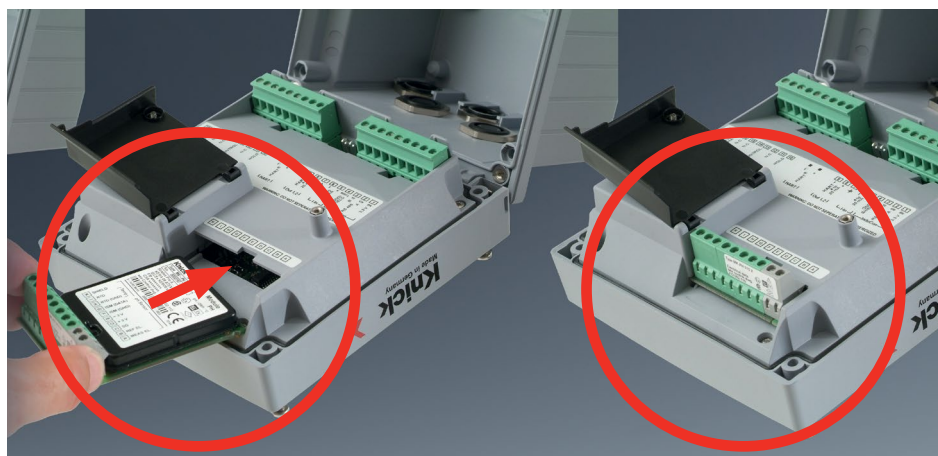

Measuring modules for connection of analog conductivity sensors:

Measuring modules for the connection of analog sensors are simply inserted into the module slot. Upon initial start-up, the analyzer automatically recognizes the module and adjusts the software correspondingly. When you replace the measuring module, you must select the corresponding measuring function in the “Service” menu.

This does not apply to the multi-channel module for dual conductivity measurement and to the connection of Memosens sensors. Here, you will be prompted to select the desired measuring function upon first start-up.

Multi-channel module for connection of analog sensors: dual conductivity

For this module, you must select the operating mode (“device type”) in the configuration menu.

Changing the Measuring Function

In the “Service” menu you can select another measuring function at any time.

Cond

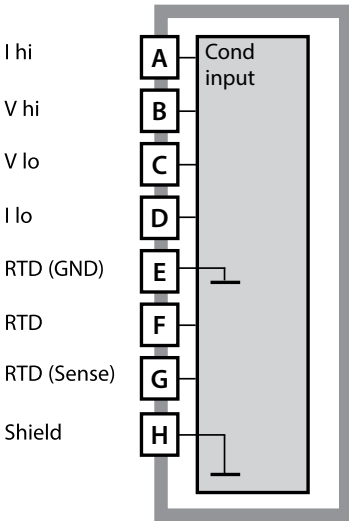

Module for contacting conductivity measurement (Cond)

Order code MK-COND025...

See the following pages for wiring examples.

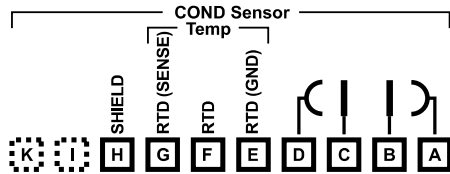

Terminal plate of module for Cond measurement

The terminals are suitable for single or stranded wires up to 2.5 mm² (AWG 14).

The measuring module comes with a self-adhesive label.

Stick the label to the module slot on the device front. This way, you have the wiring "under control".

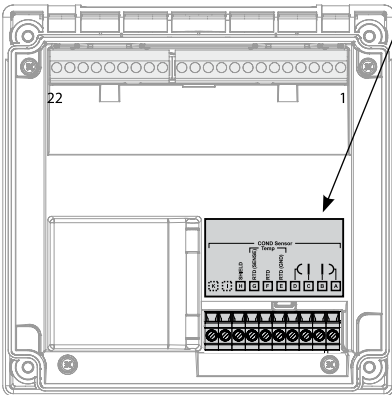

Example 1:

Measuring task: Conductivity, temperature

Sensors (principle): 4 electrodes

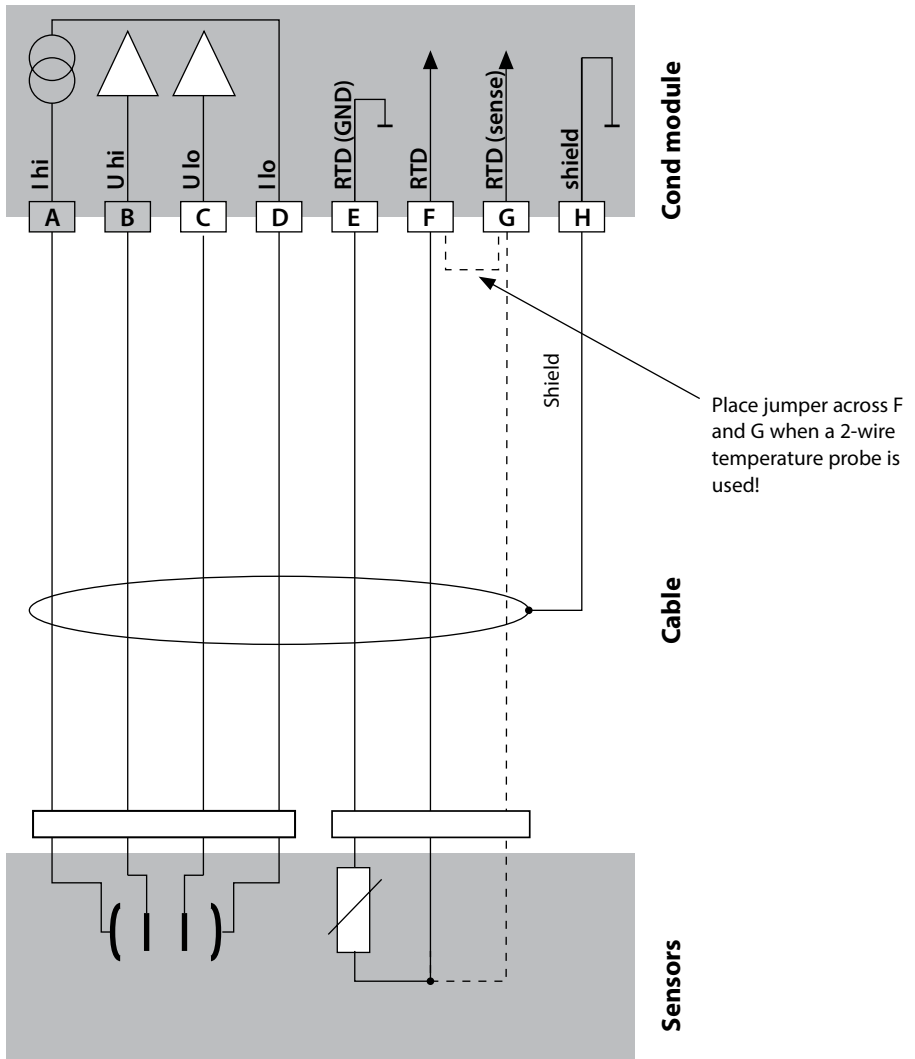

Cond

Example 2:

Measuring task: Conductivity, temperature

Sensors (principle): 2 electrodes, coaxial

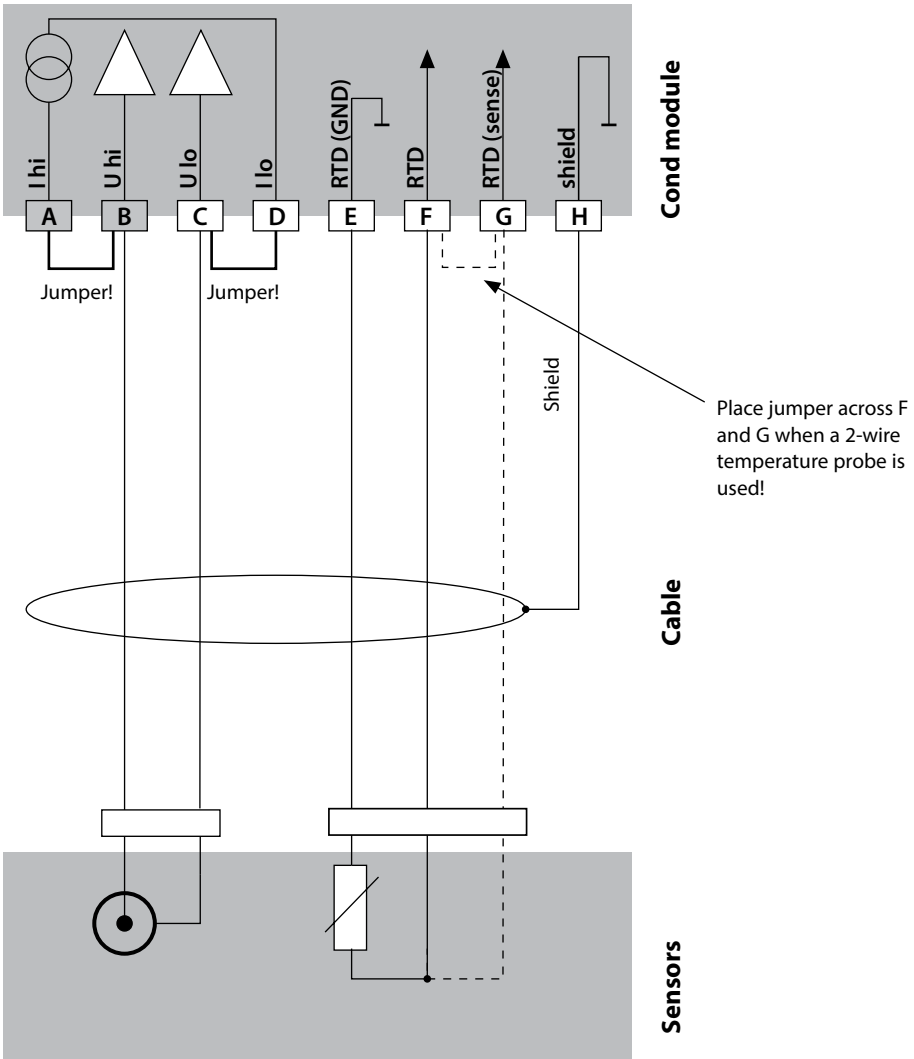

Example 3:

Measuring task: Conductivity, temperature

Sensors (example): SE 604, cable: ZU 0645

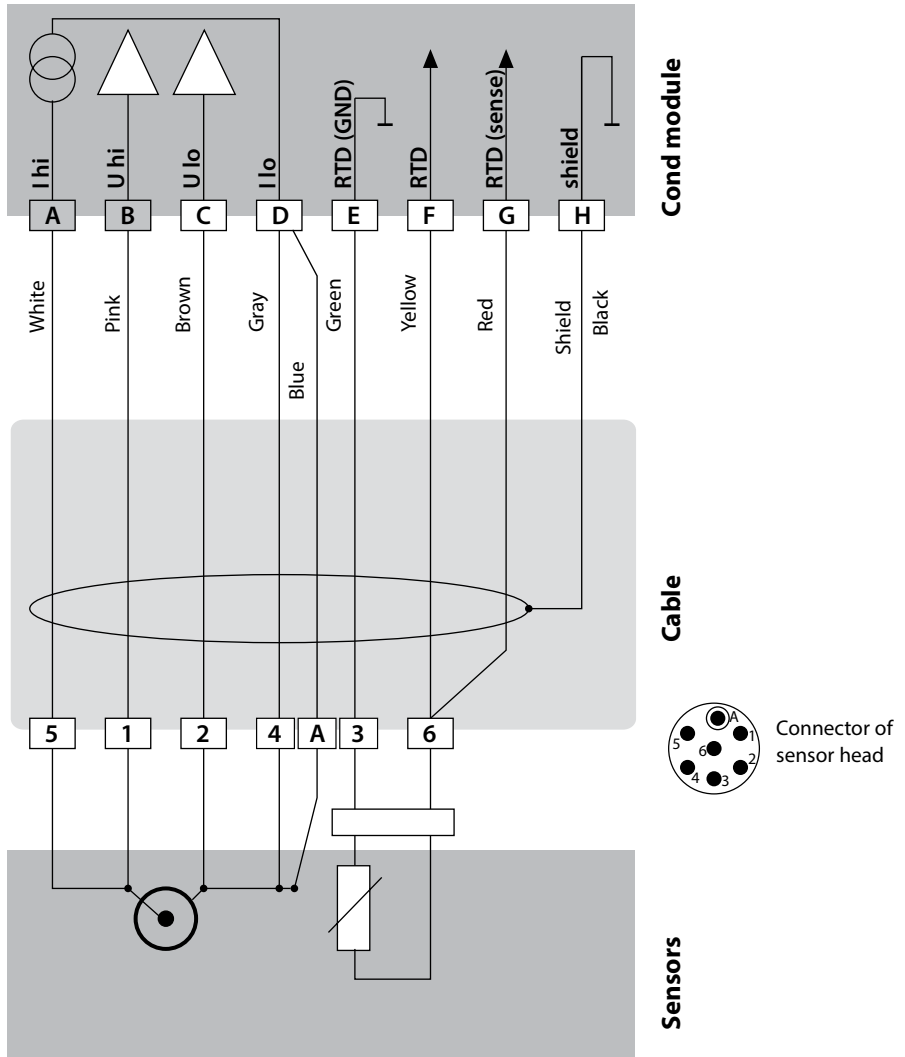

Cond

Example 4:

Measuring task: Conductivity, temperature

Sensors (example): SE 610

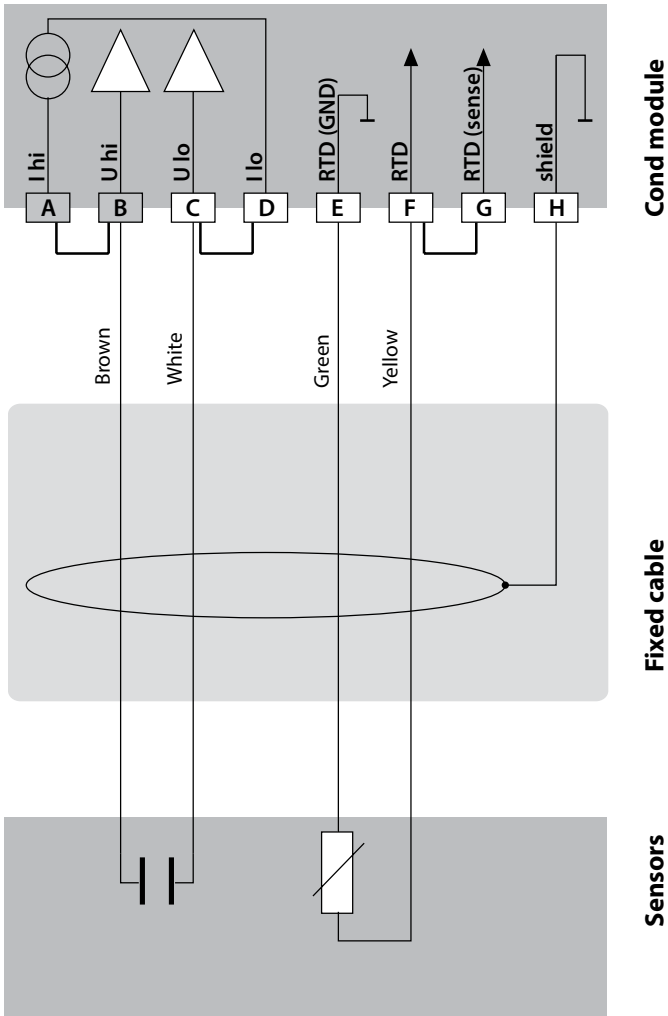

Example 5:

Measuring task: Conductivity, temperature

Sensors (example): SE 620

VP cable e.g., CA/VP6ST-003A

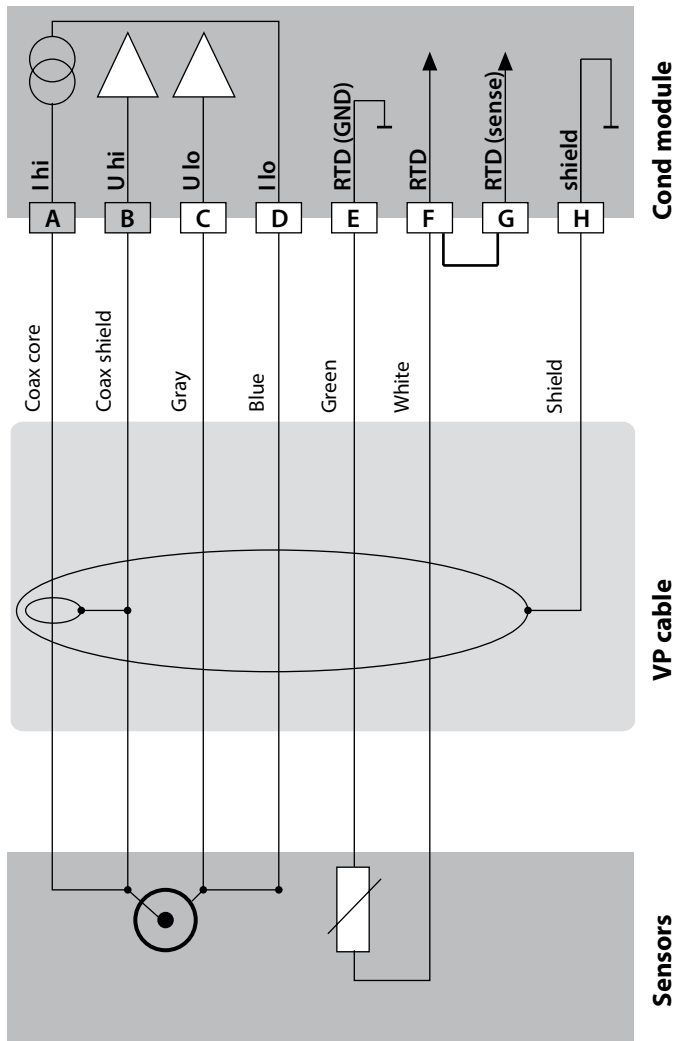

Cond

Example 6:

Measuring task: Conductivity, temperature

Sensors (example): SE 630

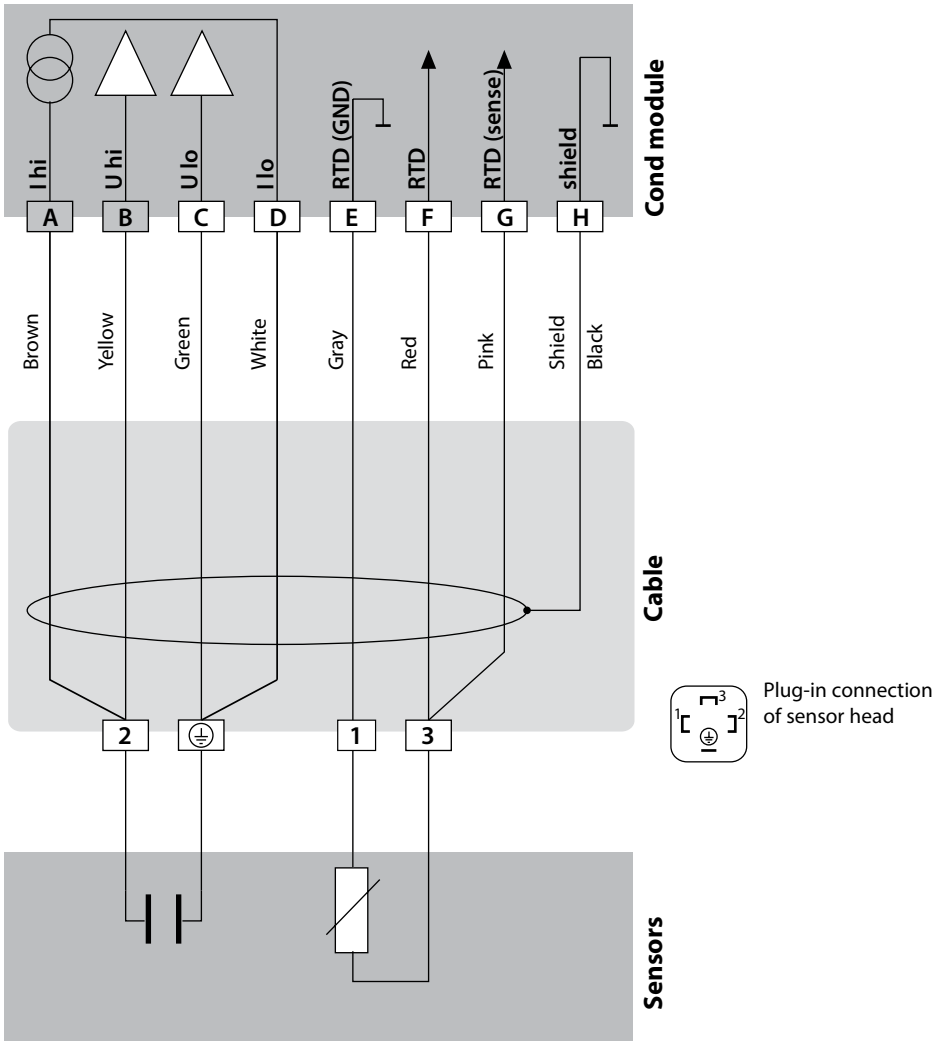

Example 7:

Measuring task: Conductivity, temperature

Sensors (example): SE 600 / SE 603 4-EL fringe-field sensor (Knick)

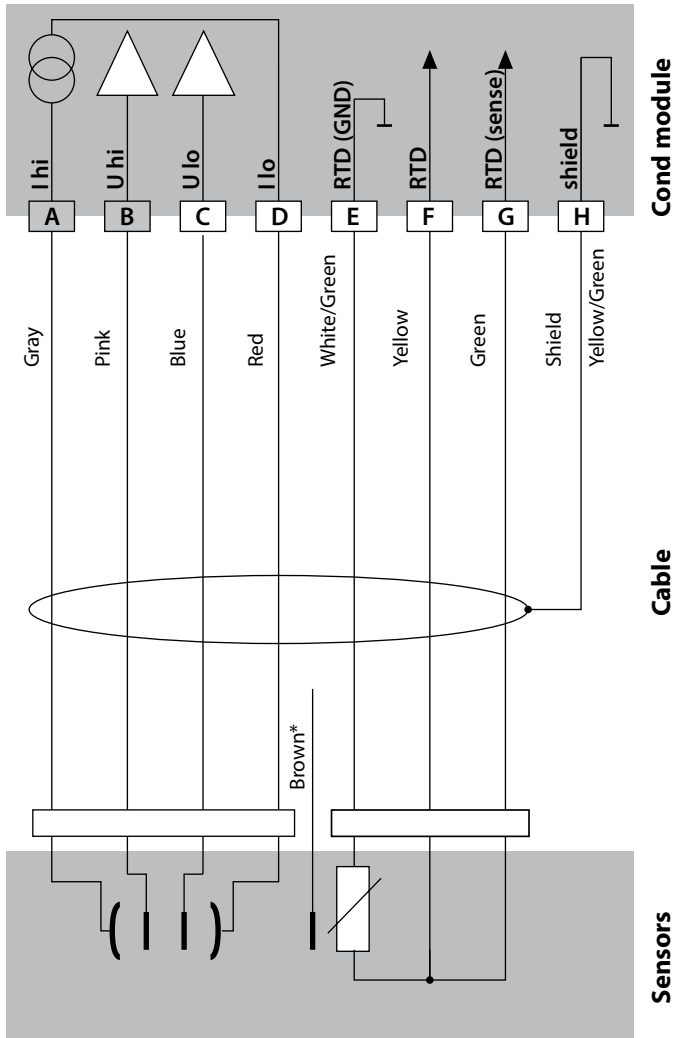

* Do not connect

Cond

Example 8:

Measuring task: Conductivity, temperature

Sensor: Memosens

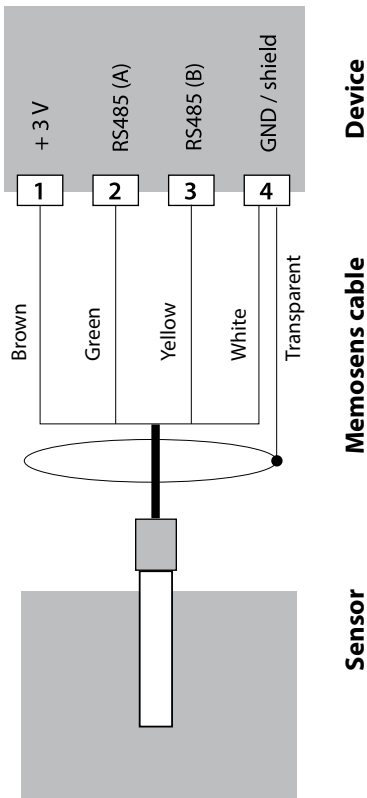
**Examples:**

SE 604(X)-MS

SE 605H-...

SE 615/1-MS

SE 630(X)-MS

Connect the Memosens sensor to the RS-485 interface of the device.

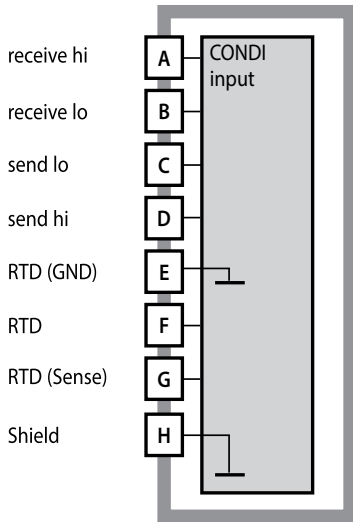

Module for inductive conductivity measurement (Condi)

Order code MK-CONDI035...

See the following pages for wiring examples.

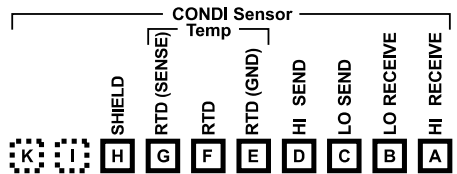

Terminal plate of Condi module

The terminals are suitable for single or stranded wires up to 2.5 mm² (AWG 14).

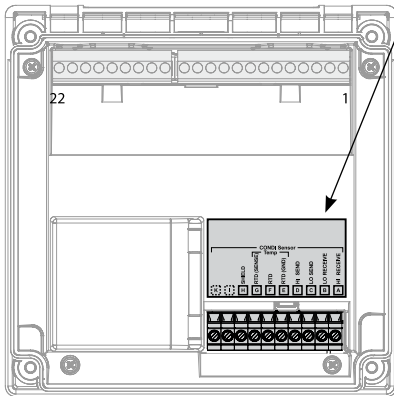

The measuring module comes with a self-adhesive label.

Stick the label to the module slot on the device front. This way, you have the wiring "under control".

Condl

Preparing the Shield Connection

Pre-assembled special cable for SE 655 / SE 656 sensors

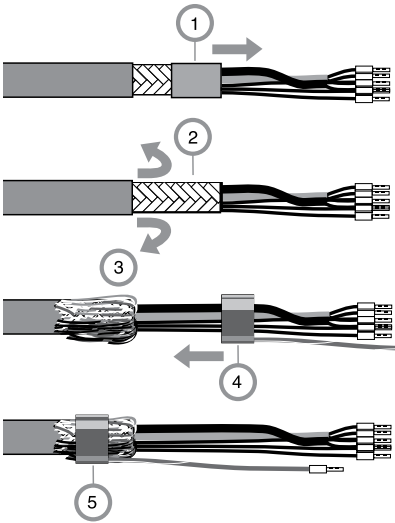

- Insert the special cable through the cable entry into the terminal compartment.
- Remove the already separated part of the cable insulation (1).
- Turn the shielding mesh (2) over the cable insulation (3).
- Then shift the crimp ring (4) over the shielding mesh and tighten it using a pincer (5)

The pre-assembled special cable:

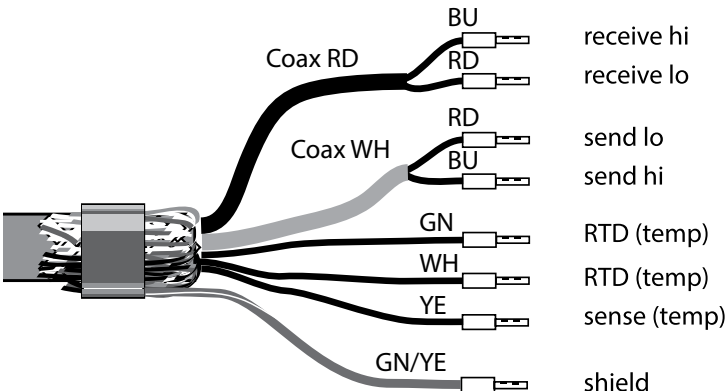

Example 1:

Measuring task: Noncontacting conductivity, temperature

Sensors: SE 655 or SE 656

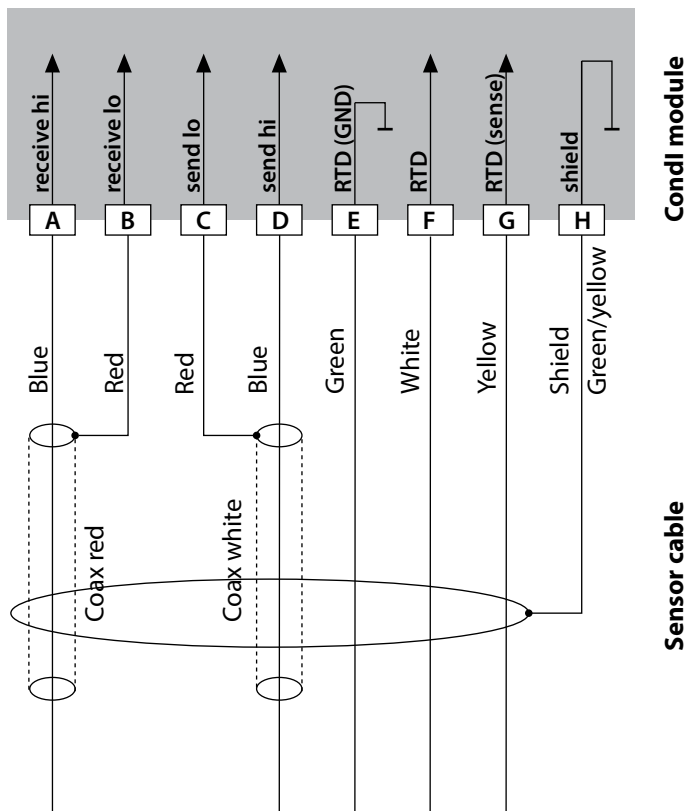

Condl

Example 2:

Measuring task: Conductivity, temperature

Sensor: SE 660

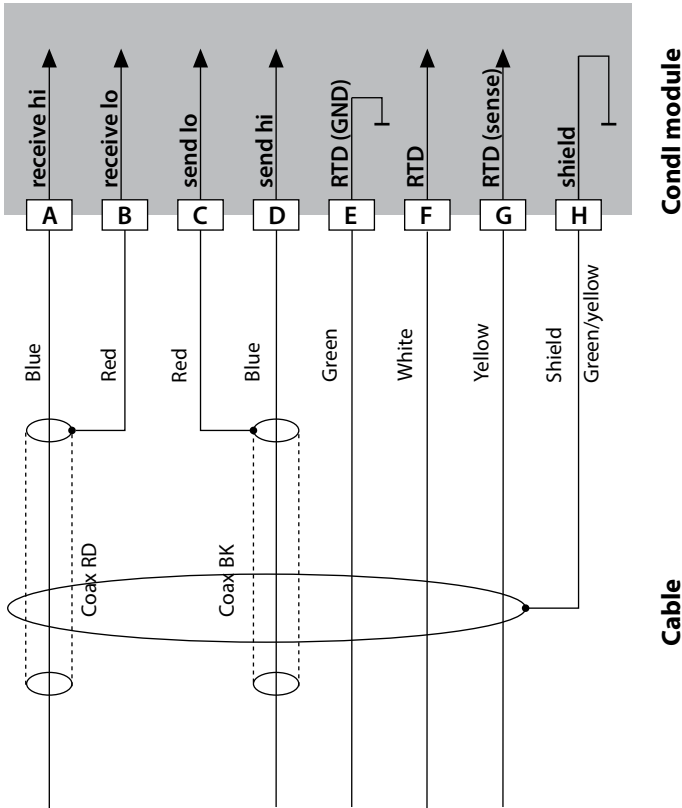

Example 3:

Measuring task: Conductivity, temperature

Sensor: Yokogawa ISC40 (Pt1000)

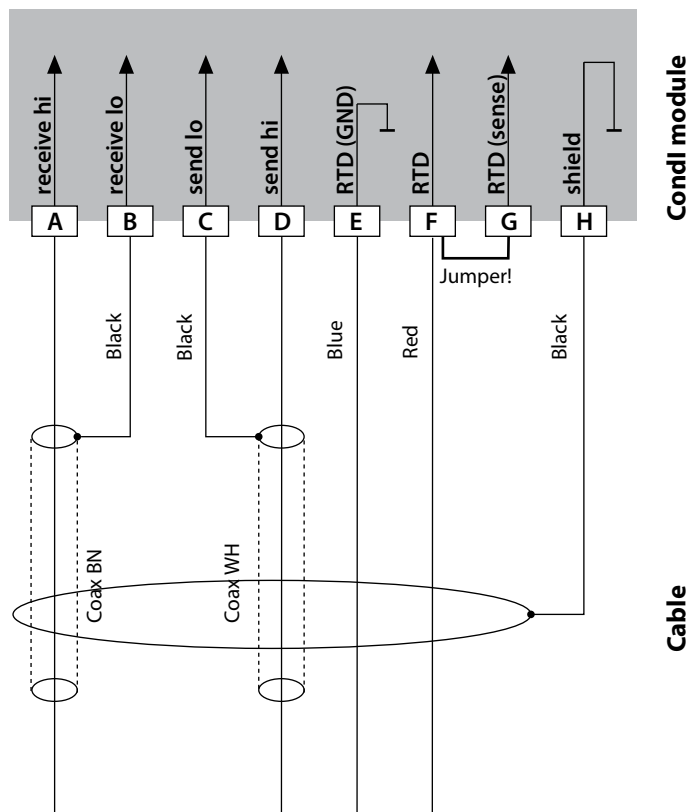

Configuration settings for this sensor:

Sensor:	Conductivity, temperature
SENSOR	OTHER
RTD TYPE	1000Pt
CELL FACTOR	1.88
TRANS RATIO	125

Condl

Example 4:

Measuring task: Conductivity, temperature
 Sensor: Yokogawa IC40S (NTC 30k)

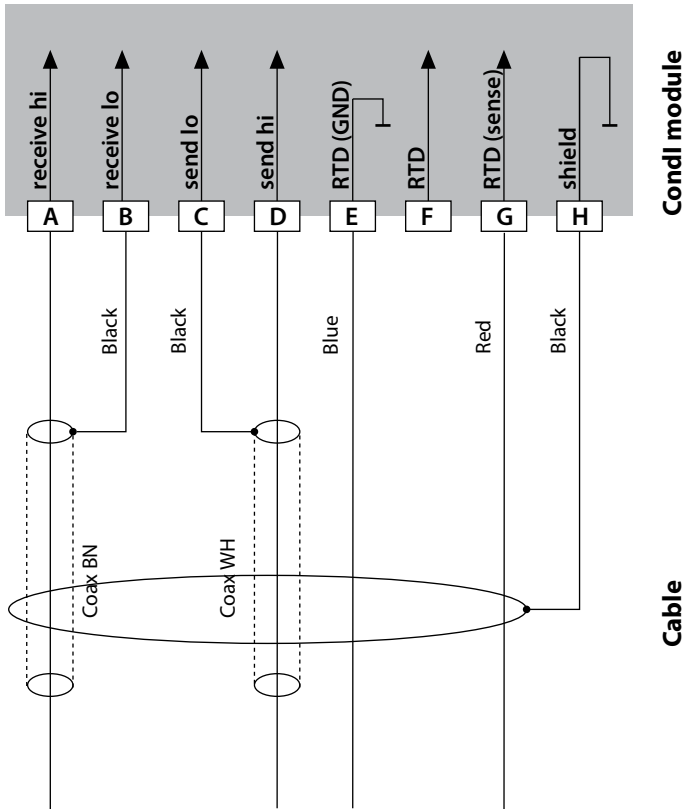
**Configuration settings for this sensor:**

Sensor:	Conductivity, temperature
SENSOR	OTHER
RTD TYPE	30 NTC
CELL FACTOR	approx. 1.7
TRANS RATIO	125

Example 5:

Measuring task: Noncontacting conductivity, temperature
 Sensor: SE 670, SE 680
 Cable: CA/M12-005NA

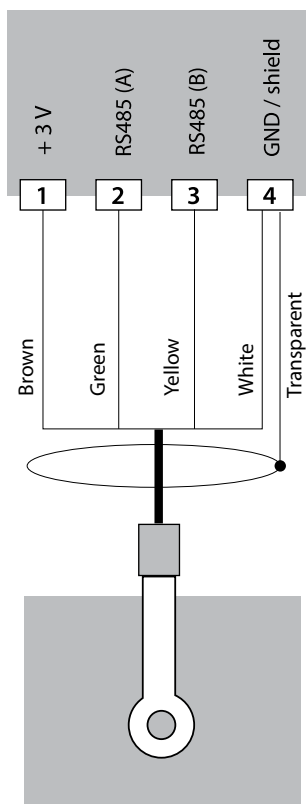

Device

Cable

Sensor, M12 connector

Cable types:

- M12/ferrules
- 5 m CA/M12-005NA
- 10 m CA/M12-010NA
- 20 m CA/M12-020NA

Connect the SE 670 / SE 680 sensor to the RS-485 interface of the device. When SE 670 / SE 680K is selected as sensor in the Configuration menu, the default values are taken as calibration data. They can then be modified by calibration. All calibration data of the SE 680M sensor with Memosens protocol are stored in the sensor.

Cond Cond

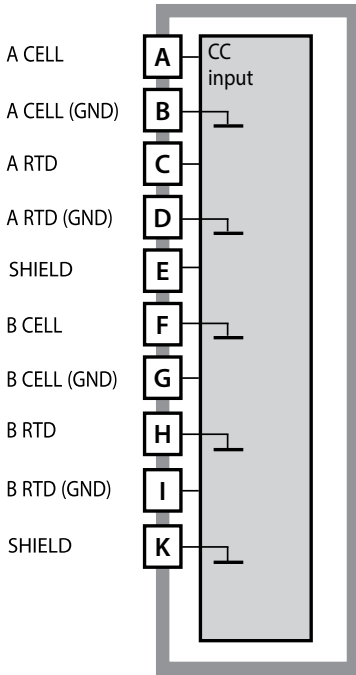

Module for dual conductivity measurement

Order code MK-CC065...

See the following pages for wiring examples.

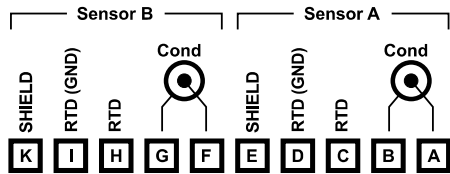

Terminal plate for dual conductivity measurement

The terminals are suitable for single or stranded wires up to 2.5 mm² (AWG 14).

The measuring module comes with a self-adhesive label. Stick the label to the module slot on the device front. This way, you have the wiring "under control".

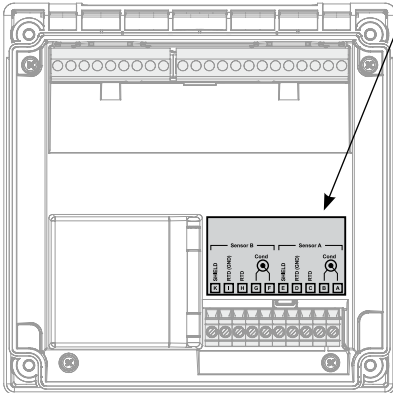

Cond

Cond

Example 1:

Measuring task: Dual conductivity, temperature

Sensors (principle): 2 x 2-electrode sensor

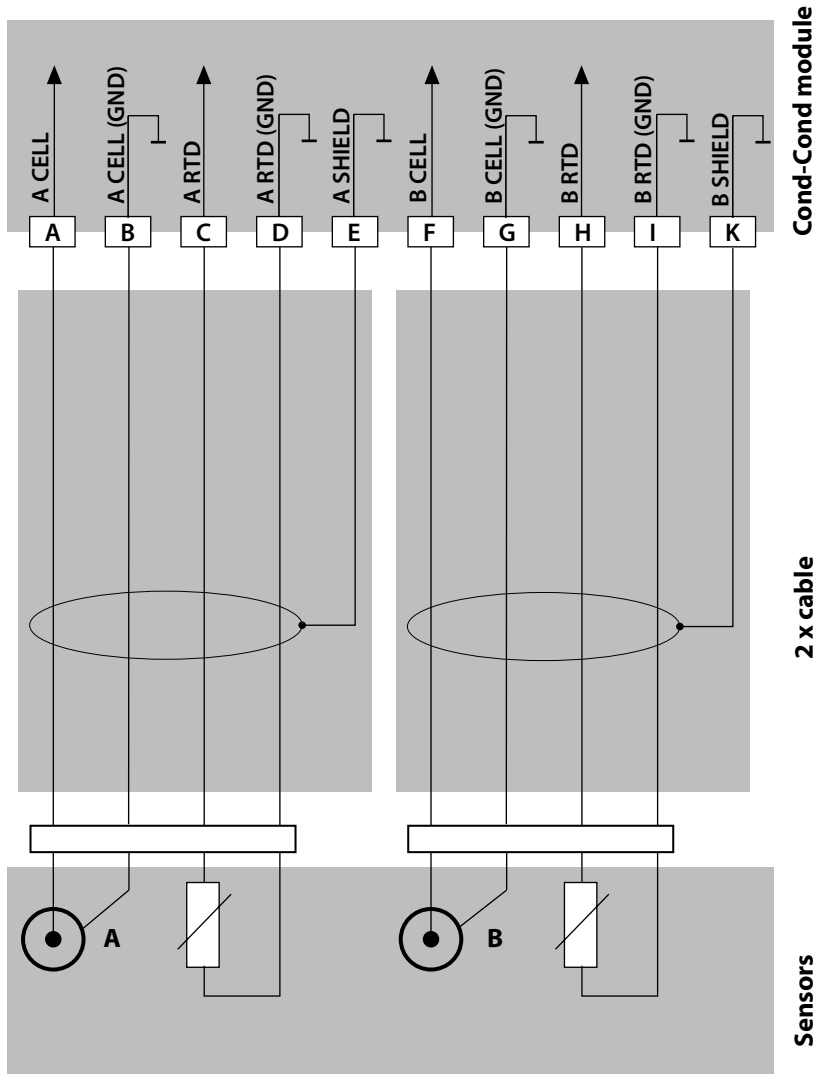

Cond

Cond

Example 2:

Measuring task: Dual conductivity, temperature
 Sensors: 2 x SE 604
 Cable: 2 x ZU 0645

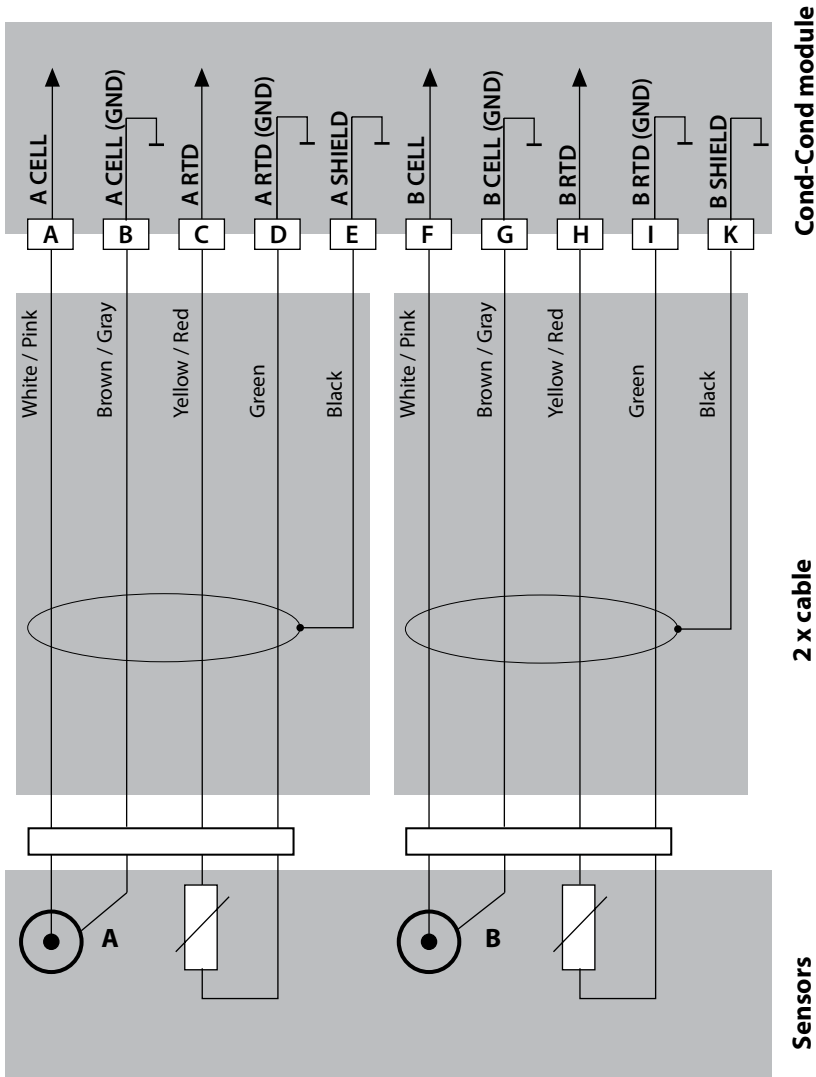

Cond

Cond

Example 3:

Measuring task: Dual conductivity, temperature

Sensors: 2 x SE 610

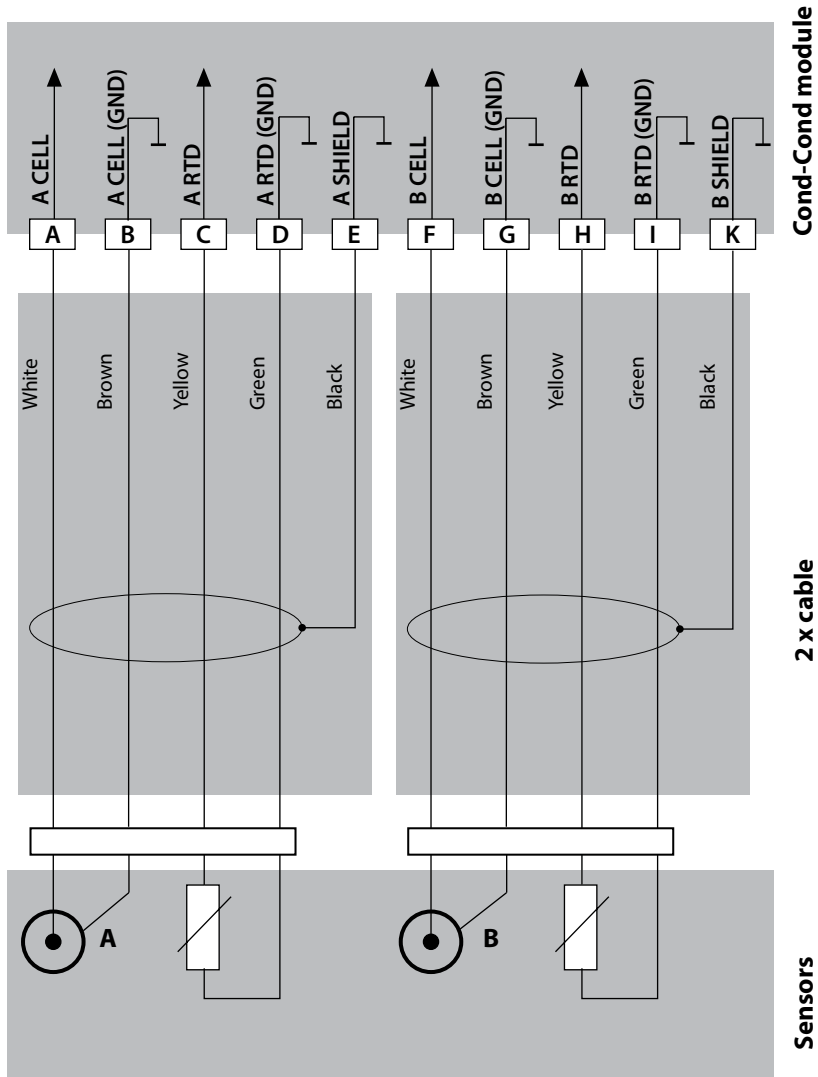

Measuring Mode

Prerequisite: A Memosens sensor is connected or a measuring module is installed with a corresponding analog sensor connected.

After the operating voltage has been connected, the analyzer automatically goes to "Measuring" mode. To call the measuring mode from another operating mode (e.g., Diagnostics, Service): Hold **meas** key depressed (> 2 s).

Sensoface indicator
(sensor status)

Time
(or flow)

Mode indicator
(measuring)

Hold **meas** key
depressed for calling
the measuring mode
(hitting the key once
more switches the
display)

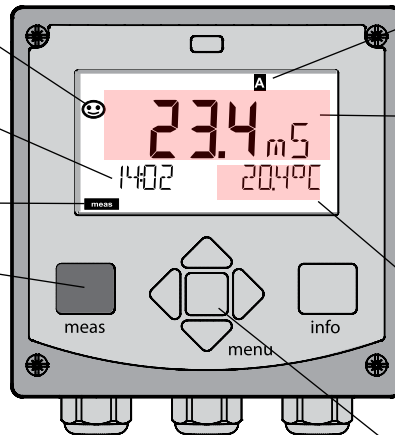

Active parameter set
(configuration)

Display indicates
OUT1:
e.g., measured
value

Display indicates
OUT2:
e.g., temperature

enter key

Depending on the configuration, you can set various displays as standard display for the measuring mode (see page 47).

Note: By pressing the **meas** key in measuring mode you can view the displays for approx. 60 sec.



NOTICE:

You must configure the analyzer for the respective measurement task.

Up / Down arrows

- Menu: Increase/decrease a numeral
- Menu: Selection

Left / Right arrows

- Menu: Previous/next menu group
- Number entry: Move between digits

meas

- Return to last menu level
- Directly to measuring mode (press > 2 s)
- Measuring mode: other display (temporarily for approx. 60 s)

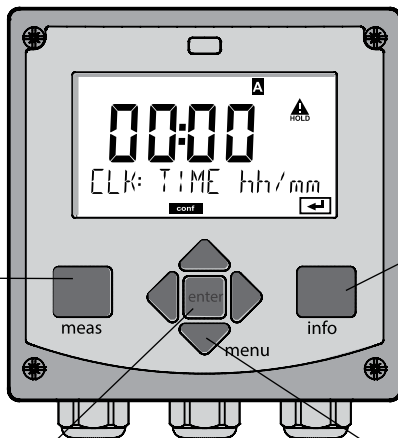

info

- Retrieve information
- Show error messages

enter

- Configuration: Confirm entries, next configuration step
- Calibration: Continue program flow

menu

- Measuring mode: Call menu

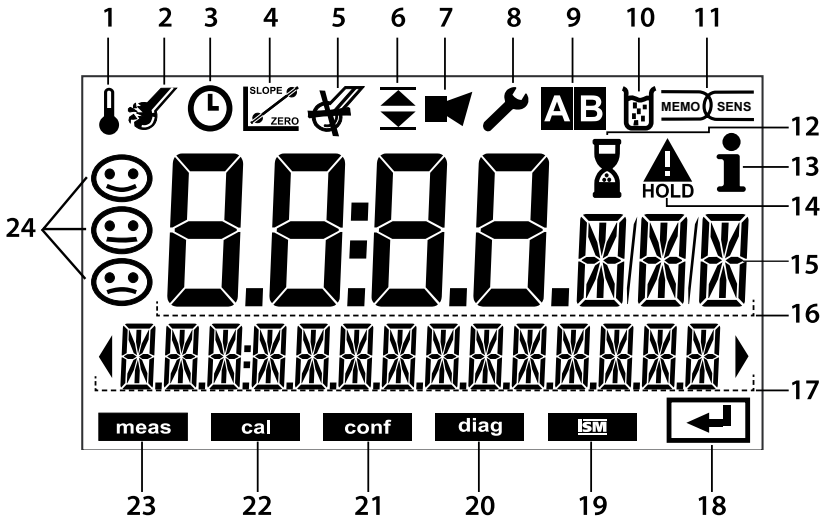

- | | | | |
|----|--|----|-----------------------|
| 1 | Temperature | 13 | Info available |
| 2 | Sensocheck | 14 | HOLD mode active |
| 3 | Interval/response time | 15 | Unit symbols |
| 4 | Sensor data | 16 | Primary process value |
| 5 | Sensocheck | 17 | Secondary display |
| 6 | Limit message:
Limit 1 ▼ or Limit 2 ▲ | 18 | Proceed using enter |
| 7 | Alarm | 19 | Not used |
| 8 | Service | 20 | Diagnostics |
| 9 | Parameter set | 21 | Configuration mode |
| 10 | Calibration | 22 | Calibration mode |
| 11 | Memosens sensor | 23 | Measuring mode |
| 12 | Waiting time running | 24 | Sensoface |

Signal Colors (Display Backlighting)

- | | |
|--------------|---|
| Red | Alarm (in case of fault: display values blink) |
| Red blinking | Input error: illegal value or wrong passcode |
| Orange | HOLD mode (Calibration, Configuration, Service) |
| Turquoise | Diagnostics |
| Green | Info |
| Magenta | Sensoface message (pre-alarm) |

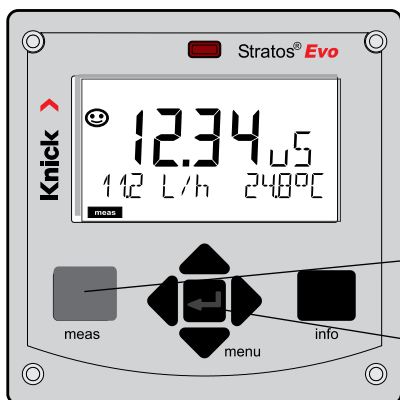

The MAIN DISPLAY is the display which is shown in measuring mode. To call the measuring mode from any other mode, hold the **meas** key depressed for at least 2 sec.

meas key

enter key

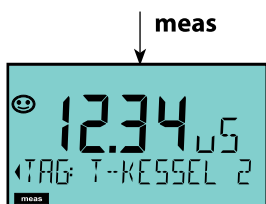

By pressing **meas** briefly you can step through further displays such as tag number (TAG) or flow (L/h).

These displays are turquoise. After 60 sec they switch back to the main display.

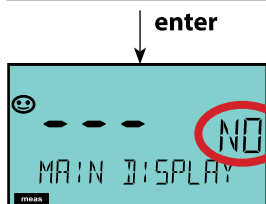
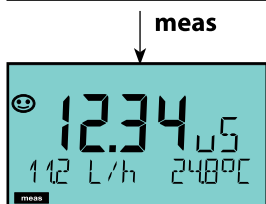

Press **enter** to select a display as MAIN DISPLAY.

The secondary display shows "MAIN DISPLAY – NO".

Use the **UP / DOWN** arrows to select "MAIN DISPLAY – YES"

and confirm by pressing **enter**.

The display color changes to white.

This display is now shown in measuring mode.



The color-coded user interface guarantees increased operating safety. Operating modes are clearly signaled.

The normal measuring mode is white. Information text appears on a green screen and the diagnostic menu appears on turquoise. The orange HOLD mode (e.g., during calibration) is quickly visible as is the magenta screen which indicates asset management messages for predictive diagnostics – such as maintenance request, pre-alarm and sensor wear.

The alarm status has a particularly noticeable red display color and is also signaled by flashing display values. Invalid inputs or false passcodes cause the entire display to blink red so that operating errors are significantly reduced.

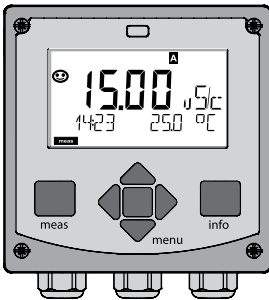

White:
Measuring mode

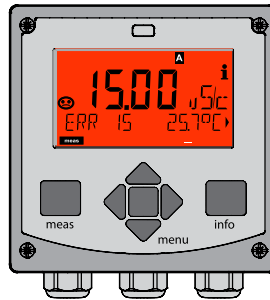

Red blinking:
Alarm, error

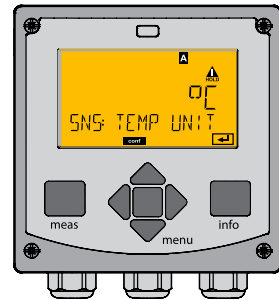

Orange:
HOLD mode

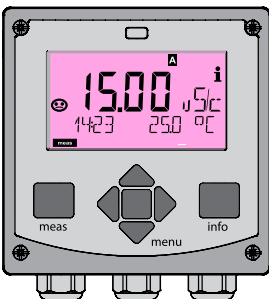

Magenta:
Maintenance request

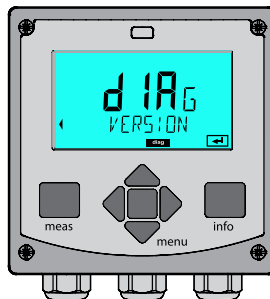

Turquoise:
Diagnostics

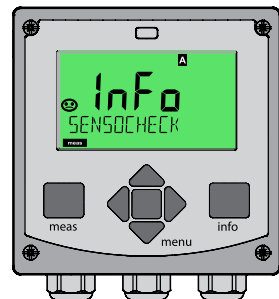

Green:
Info texts

To select the operating mode:

- 1) Hold **meas** key depressed (> 2 s) (measuring mode)
- 2) Press **menu** key: the selection menu appears
- 3) Select operating mode using left / right arrow key
- 4) Press **enter** to confirm the selected mode

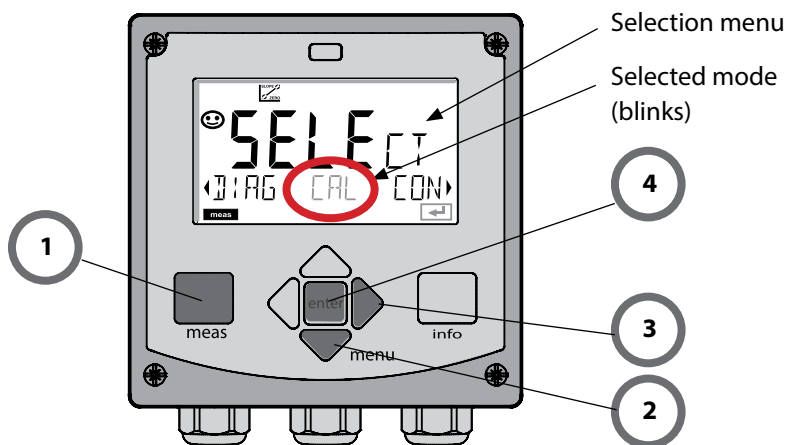

To enter a value:

- 5) Select numeral: left / right arrow
- 6) Change numeral: up / down arrow
- 7) Confirm entry by pressing **enter**

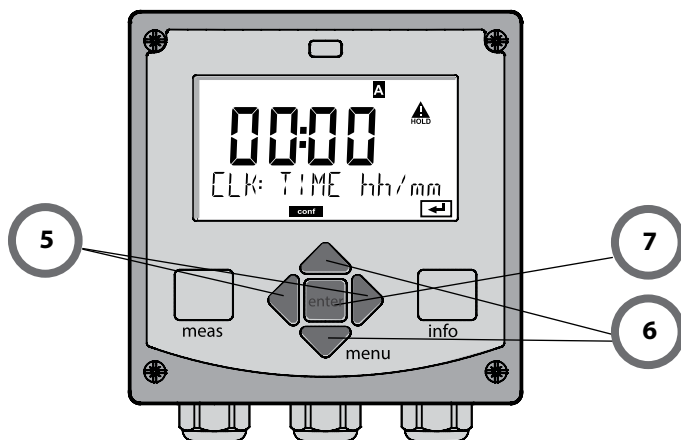

Diagnostics

Display of calibration data, display of sensor data, sensor monitor, performing a device self-test, viewing the logbook entries, display of hardware/software versions of the individual components. The logbook can store 100 events (00...99). They can be displayed directly on the device. The logbook can be extended to 200 entries using a TAN (Option).

HOLD

Manual activation of HOLD mode, e.g., for replacing a sensor. The signal outputs adopt a defined state.

Calibration

Every sensor has typical characteristic values, which change in the course of the operating time. Calibration is required to supply a correct measured value. The device checks which value the sensor delivers when measuring in a known solution. When there is a deviation, the device can be "adjusted". In that case, the device displays the "actual" value and internally corrects the measurement error of the sensor. Calibration must be repeated at regular intervals. The time between the calibration cycles depends on the load on the sensor. During calibration the device is in HOLD mode.

During calibration the device remains in the HOLD mode until it is stopped by the operator.

Configuration

You must configure the analyzer for the respective measurement task. In the "Configuration" mode you select the adjusted measuring function, the connected sensor, the measuring range to be transmitted, and the conditions for warning and alarm messages. During configuration the device is in HOLD mode.

Configuration mode is automatically exited 20 minutes after the last keystroke. The device returns to measuring mode.

Service

Maintenance functions (current source, relay test, controller test), passcode assignment, device type selection, reset to factory settings, enabling of options (TAN).

The HOLD mode is a safety state during configuration and calibration. Output current is frozen (LAST) or set to a fixed value (FIX). Alarm and limit contacts are disabled.

The display backlighting turns orange, display icon: 

Output signal response

- **LAST:** The output current is frozen at its last value. Recommended for short configuration procedures. The process should not change decisively during configuration. Changes are not noticed with this setting!
- **Fix:** The output current is set to a value that is noticeably different from the process value to signal the control system that the device is being worked at.

Output signal during HOLD:

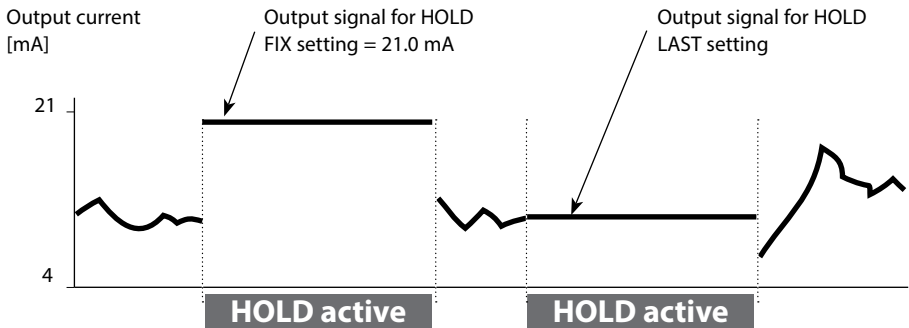

Terminating the HOLD mode

The HOLD mode is exited by switching to measuring mode (hold **meas** key depressed). The display reads “Good Bye”. After that, the HOLD mode is exited. When the calibration mode is exited, a confirmation prompt ensures that the installation is ready for operation (e.g.: sensor reinstalled, located in process).

External activation of HOLD

The HOLD mode can be activated from outside by sending a signal to the HOLD input (e.g., from the process control system).

HOLD inactive	0...2 V AC/DC
HOLD active	10...30 V AC/DC

Alarm

When an error has occurred, **Err xx** is displayed immediately.

Only after expiry of a user-defined delay time will the alarm be registered and entered in the logbook.

During an alarm the display blinks, the display backlighting turns **red**.

Error messages can also be signaled by a 22 mA output current (when configured correspondingly).

The alarm contact is activated by alarm or power failure. 2 sec after the failure event is corrected, the alarm status will be deleted.

The 22-mA signal can also be triggered by Sensoface messages (configurable).

Generating a message via the CONTROL input

(min. flow / max. flow)

The CONTROL input can be used for parameter set selection or for flow measurement (pulse principle), depending on its assignment in the "Configuration" menu. First, the flow transmitter must be calibrated in the CONTROL menu: ADJUST FLOW

When preset to flow measurement

CONF/CNTR_IN/CONTROL = FLOW

an alarm can be generated when the measured flow exceeds a specified range:

CONF/ALA/FLOW CNTR = ON

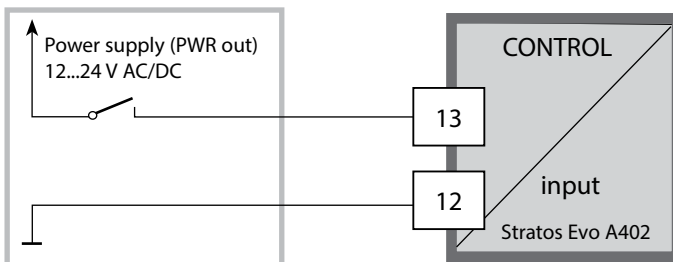

CONF/ALA/FLOW min (specify value, default: 5 liters/h)

CONF/ALA/FLOW max (specify value, default: 25 liters/h)

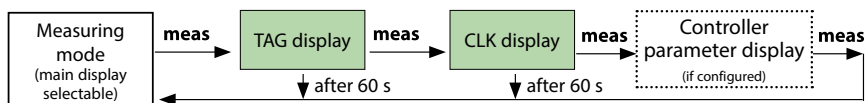



Pressing the **menu** key (down arrow) opens the selection menu.
 Select the menu group using the left/right arrow keys.
 Pressing **enter** opens a menu item. Press **meas** to return.

		
DIAG	<ul style="list-style-type: none"> CALDATA SENSOR SELFTEST LOGBOOK MONITOR VERSION 	<ul style="list-style-type: none"> Display of calibration data Display of sensor data Self test: RAM, ROM, EEPROM, module 100 events with date and time Display of direct sensor values Display of software version, model designation, serial no.
HOLD		Manual activation of HOLD mode, e.g., for sensor replacement. The signal outputs behave as configured (e.g., last measured value, 21 mA)
CAL	<ul style="list-style-type: none"> pH Oxy COND(I) CAL_RTDT 	<ul style="list-style-type: none"> pH adjustment / ORP adjustment / product calibration Adjustment (WTR/AIR) / zero adjustment / product cal. Adjustment with solution / cell factor input / prod. cal. Adjustment of temperature probe
CONF	<ul style="list-style-type: none"> PARSET A PARSET B 	<div style="background-color: #e0e0e0; padding: 10px; border: 1px solid #ccc;"> <p>For configuring parameter set A / B see "Overview of Configuration" on next page.</p>  </div>
SERVICE (Access via code, factory setting: 5555)	<ul style="list-style-type: none"> MONITOR SENSOR POWER OUT OUT1 OUT2 RELAIS CONTROL CODES DEVICE TYPE DEFAULT OPTION 	<ul style="list-style-type: none"> Display of measured values for validation (simulators) Sensor (resetting diagnostics messages) Selecting the output voltage (3.1 V / 12 V / 15 V / 24 V) Current source, output 1 Current source, output 2 Relay test Controller: manual specification of controller output Specifying access codes for operating modes Selecting the device type Reset to factory setting Enabling an option via TAN

The configuration steps are assigned to different menu groups. Using the left/right arrow keys, you can jump between the individual menu groups. Each menu group contains menu items for setting the parameters. Pressing **enter** opens a menu item. Use the arrow keys to edit a value. Press **enter** to confirm/save the settings. Return to measurement: Hold **meas** key depressed (> 2 s).

Select menu group	Menu group	Code	Display	Select menu item
	Sensor selection (multi-channel device: select sensor A / sensor B)	SNS: (S_A / S_B)	Conf SENSOR	
		Menu item 1		
		:		
		Menu item ...		
▶	Current Output 1	OT1:	Conf OUT 1	
▶	Current output 2	OT2:	Conf OUT 2	
▶	Compensation	COR:	Conf CORRECTION	
▶	Control input (parameter set or flow measurement)	IN:	0000 COR: TC L: BU: 1	
▶	Alarm mode	ALA:	Conf ALARM	
▶	Relay outputs	REL:	Conf REL 1/REL 2	
▶	Cleaning	WSH:	Conf WASH	
▶	Setting the clock	CLK:	Conf CLOCK	
▶	Tag number	TAG:	Conf TAG	

Note:

With Cond-Cond, the two parameter sets are replaced by the two sensors A and B.

Parameter Set A/B: Configurable Menu Groups

The device provides 2 parameter sets "A" and "B". By switching between the parameter sets you can adapt the device to different measurement situations, for example. Parameter set "B" only permits setting of process-related parameters.

Menu group	Parameter set A	Parameter set B
SENSOR	Sensor selection	---
OUT1	Current output 1	Current output 1
OUT2	Current output 2	Current output 2
CORRECTION	Compensation	Compensation
CNTR_IN	Control input	---
ALARM	Alarm mode	Alarm mode
REL 1/REL 2	Relay outputs	Relay outputs
WASH	Cleaning (not for Cond-Cond devices)	---
PARSET	Parameter set selection (not for Cond-Cond devices)	---
CLOCK	Setting the clock	---
TAG	TAG of measuring point	
GROUP	GROUP of measuring points	

External switchover of parameter sets A/B

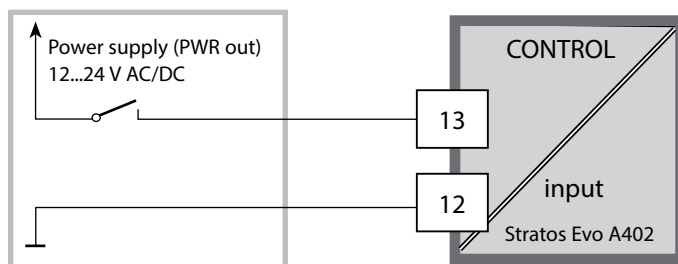

You can switch between parameter sets A and B by applying a signal to the CONTROL input (setting: CNTR-IN – PARSET).



Parameter set A active 0...2 V AC/DC

Parameter set B active 10...30 V AC/DC

Parameter Set A/B: Manual Switchover

Display	Action	Remark
	To switch between parameter sets: Press meas	Manual selection of parameter sets must have been preset in CONFIG mode. Default setting is a fixed parameter set A. Wrong settings change the measurement properties!
	PARSET blinks in the lower line. Select parameter set using ◀ and ▶ keys.	
	Select PARSET A / PARSET B	The currently active parameter set is read on the display:
	Press enter to confirm. Cancel by pressing meas	

Parameter Set A/B: Signaling via WASH Contact

(not for device type CC)

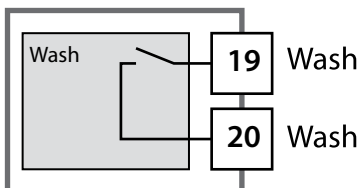





The active parameter set can be signaled using the WASH contact:

If configured correspondingly, the WASH contact signals:

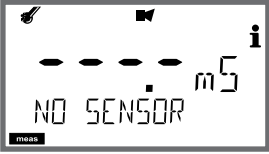
Parameter set A: Contact open

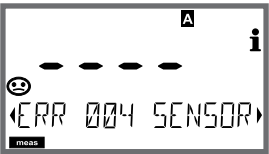
Parameter set B: Contact closed

Step	Action/Display	Remark
Connect sensor		<p>First select "Sensor type Memosens" or "SE680-M" in the Configuration.</p> <p>Note: When no Memosens sensor is connected, the error message "NO SENSOR" is displayed.</p>
Wait until the sensor data are displayed.		<p>The hourglass in the display blinks.</p>
Check sensor data	 <p>View sensor information using ◀ ▶ keys, confirm using enter.</p>	<p>Sensoface is friendly when the sensor data are okay.</p>
Go to measuring mode	<p>Press meas, info or enter</p>	<p>After 60 sec the device automatically returns to measuring mode (timeout).</p>
Possible error message		
<p>Sensor defective. Replace sensor</p>		<p>When this error message appears, the sensor cannot be used. Sensoface is sad.</p>

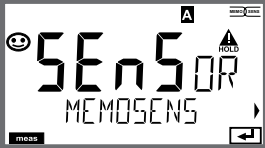
Step	Action/Display	Remark
Select HOLD mode A sensor should only be replaced during HOLD mode to prevent unintended reactions of the outputs or contacts.	Press menu key to call the selection menu, select HOLD using the ◀ ▶ keys, press enter to confirm.	Now the device is in HOLD mode. The HOLD mode can also be activated externally via the HOLD input. During HOLD the output current is frozen at its last value or set to a fixed value.
Disconnect and remove old sensor		
Install and connect new sensor.		Temporary messages which are activated during the replacement are indicated but not output to the alarm contact and not entered in the logbook.
Wait until the sensor data are displayed.		
Check sensor data	 <p>View sensor information using ◀ ▶ keys, confirm using enter.</p>	You can view the sensor manufacturer and type, serial number and last calibration date.
Check measured values		
Exit HOLD	Hit meas key: Return to the selection menu. Hold meas key depressed: Device switches to measuring mode.	

Overview of Cond Sensor Configuration

Cond sensor		Choices	Default
SNS:		2-ELECTRODE 4-ELECTRODE MEMOSENS	2-ELECTRODE
2-EL / 4-EL	CELLFACTOR	00.0000 - 19.9999 c	01.0000 c
MEAS MODE		Cond Conc % Sal ‰ USP µS/cm	Cond
Cond	MEAS RANGE	x.xxx µS/cm xx.xx µS/cm xxx.x µS/cm xxxx µS/cm x.xxx mS/cm xx.xx mS/cm xxx.x mS/cm x.xxx S/m xx.xx S/m xx.xx MΩ	xxx.x mS/cm
Conc	Solution	-01- (NaCl) -02- (HCl) -03- (NaOH) -04- (H2SO4) -05- (HNO3) -06- (H2SO4) -07- (HCl) -08- (HNO3) -09- (H2SO4) -10- (NaOH) -11-(H ₂ SO ₄ •SO ₃) (oleum)	-01- (NaCl)
TEMP UNIT		°C / °F	°C
TEMPERATURE (EXT. only with I-input enabled via TAN)		AUTO MAN EXT (only if enabled via TAN)	AUTO
AUTO	RTD TYPE	100 PT 1000 PT 8.55 NTC 30 NTC Ni100	100 PT
MAN	TEMPERATURE	-50 ... 250 °C (-58 ... 482 °F)	025.0 °C (077.0 °F)

Cond

Device Type: Cond

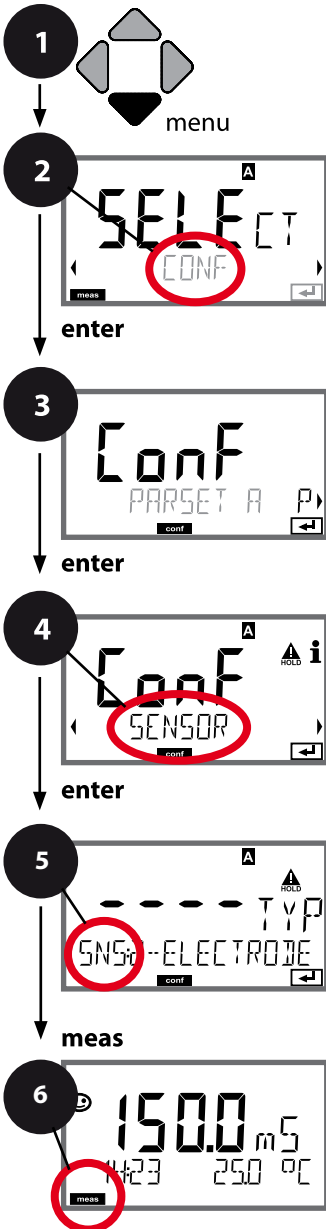

Connected modules are automatically recognized. When no module is installed, but a Memosens sensor is connected at initial start-up, it is recognized and the corresponding process variable is automatically selected. In the SERVICE menu you can change the device type. Afterwards, you must select the corresponding calibration mode in the CONF menu.

- 1 Press **menu**.
- 2 Select **CONF** using **◀ ▶**, press **enter**.
- 3 Select parameter set using **◀ ▶** keys, press **enter**.
- 4 Select **SENSOR** menu using **◀ ▶** keys, press **enter**.
- 5 All items of this menu group are indicated by the "SNS:" code. Press **enter** to select menu, edit using arrow keys (see next page). Confirm (and proceed) by pressing **enter**.
- 6 Exit: Press **meas** key until the [meas] mode indicator is displayed.

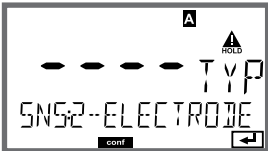
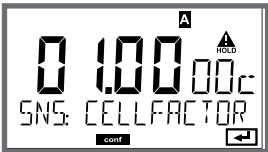
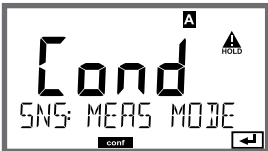
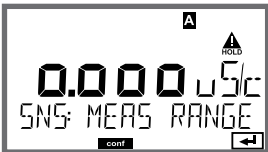

5	Select sensor type	enter
	Enter cell constant	enter
	Select measuring mode	enter
	Select measuring range	
	Concentration determination	
	Temperature unit	
	Temperature detection	
	Select type of temp probe	
	Cleaning cycles	
	Sterilization cycles	
	CHECK TAG	
	CHECK GROUP	

5

Menu item	Action	Choices
<p>Select sensor type</p> 	<p>Select sensor type using ▲ ▼ keys.</p> <p>Press enter to confirm.</p>	<p>2-ELECTRODE 4-ELECTRODE MEMOSENS</p>
<p>Enter cell constant</p> 	<p>Modify digit using ▲ ▼ keys, select next digit using ◀ ▶ keys.</p> <p>Press enter to confirm.</p>	<p>00.0050 ... 19.9999 c (01.0000 c)</p>
<p>Select measuring mode</p> 	<p>Select desired mode using ▲ ▼ keys.</p> <p>Press enter to confirm.</p>	<p>Cond Conc % Sal % USP μS/cm</p>
<p>Select measuring range</p> 	<p>For cond measurement only</p> <p>Select desired measuring range using ▲ ▼ keys.</p> <p>Press enter to confirm.</p>	<p>x.xxx μS/cm, xx.xx μS/cm xxx.x μS/cm, xxx μS/cm x.xxx mS/cm, xx.xx mS/cm xxx.x mS/cm, x.xxx S/m xx.xx S/m, xx.xx MΩ</p>
<p>Concentration determination</p> 	<p>For conc measurement only</p> <p>Select desired concentration solution using ▲ ▼ keys.</p> <p>Press enter to confirm.</p>	<p>-01- (NaCl) -02- (HCl) -03- (NaOH) -04- (H₂SO₄) -05- (HNO₃) -06- (H₂SO₄) -07- (HCl) -08- (HNO₃) -09- (H₂SO₄) -10- (NaOH) -11- (H₂SO₄+SO₃) (oleum)</p>

Cond

According to the "USP" directive (U.S.Pharmacopeia), Section 645 "Water Conductivity" the conductivity of pharmaceutical waters can be monitored online. To do so, the conductivity is measured without temperature compensation and is compared with limit values (see table on next page).

The water is usable when the conductivity is below the USP limit. If the conductivity values are higher, further test steps must be performed according to the directive. To increase safety, the USP limit value can be reduced in the device. To do so, a factor (%) is specified.

Configuration steps

- **SNS** menu group:
When USP function has been selected, the measuring range is fixed to 00.00.....99.99 $\mu\text{S/cm}$. Temperature compensation is switched off.
Temperature is monitored.
- Access **REL** menu group and select USP FUNCT. as limit function.
Relays 1 and 2 can now be used as USP limit contacts.
- Reduced limit contact **REL1**:
Enter USP factor (reduced USP limit, configurable in the range 10 %...100 %).
Set contact response for relay 1.
Set delay time.
- Limit contact **REL2**:
REL 2 is permanently set to the USP limit (100%).
Set contact response for relay 2.
Set delay time.

Temperature/conductivity table as per USP

Temp (°C)	Cond (μS/cm)	Temp (°C)	Cond (μS/cm)
0	0.6	55	2.1
5	0.8	60	2.2
10	0.9	65	2.4
15	1.0	70	2.5
20	1.1	75	2.7
25	1.3	80	2.7
30	1.4	85	2.7
35	1.5	90	2.7
40	1.7	95	2.9
45	1.8	100	3.1
50	1.9		

Limit values for USP function

Limit contact response REL1 and REL2

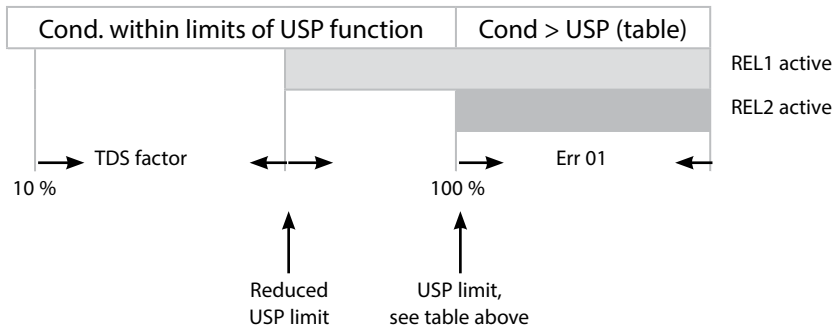

Cond



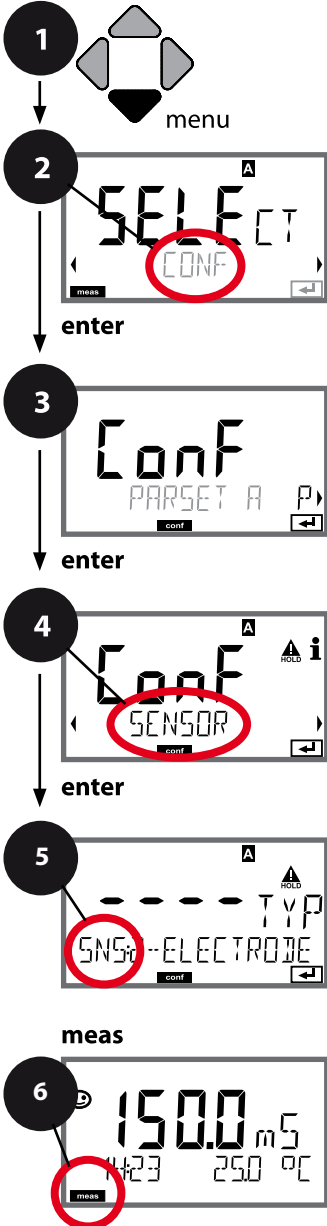

SENSOR, Temperature Unit, Temp Detection, Temperature Probe

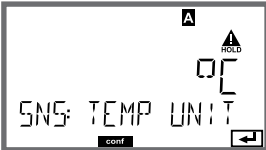
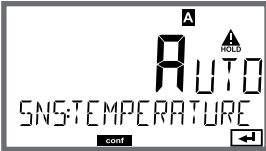

- 1 Press **menu** key.
- 2 Select **CONF** using ◀ ▶, press **enter**.
- 3 Select parameter set using ◀ ▶ keys, press **enter**.
- 4 Select **SENSOR** menu using ◀ ▶ keys, press **enter**.
- 5 All items of this menu group are indicated by the "SNS:" code. Press **enter** to select menu, edit using arrow keys (see next page). Confirm (and proceed) by pressing **enter**.
- 6 Exit: Press **meas** key until the [meas] mode indicator is displayed.

Select sensor type	
Enter cell constant	
Select measuring mode	
Select measuring range	
Concentration determination	
Temperature unit	
Temperature detection	
Select type of temp probe	
Cleaning cycles	
Sterilization cycles	
CHECK TAG	
CHECK GROUP	

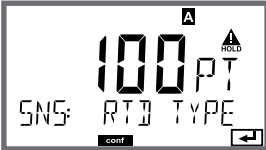
5

Menu item	Action	Select
<p>Temperature unit</p> 	<p>Select °C or °F using ▲ ▼ keys.</p> <p>Press enter to confirm.</p>	<p>°C / °F</p>
<p>Temp detection</p> 	<p>Select mode using ▲ ▼ keys: AUTO: Measured by sensor MAN: Direct input of temperature, no measurement (see next step) EXT: Temperature specified via current input (only if enabled via TAN)</p> <p>Press enter to confirm.</p>	<p>AUTO MAN EXT</p>
<p>(Manual temperature)</p> 	<p>Modify digit using ▲ ▼ keys, select next digit using ◀ ▶ keys.</p> <p>Press enter to confirm.</p>	<p>–50...250 °C (–58...482 °F)</p>
<p>Select type of temp probe</p>  	<p>(not for Memosens) Select type of temperature probe using ▲ ▼ keys.</p> <p>Press enter to confirm.</p>	<p>100 PT 1000 PT 30 NTC 8.55 NTC Ni100</p>

Cond

Sensor, Cleaning Cycles, Sterilization Cycles

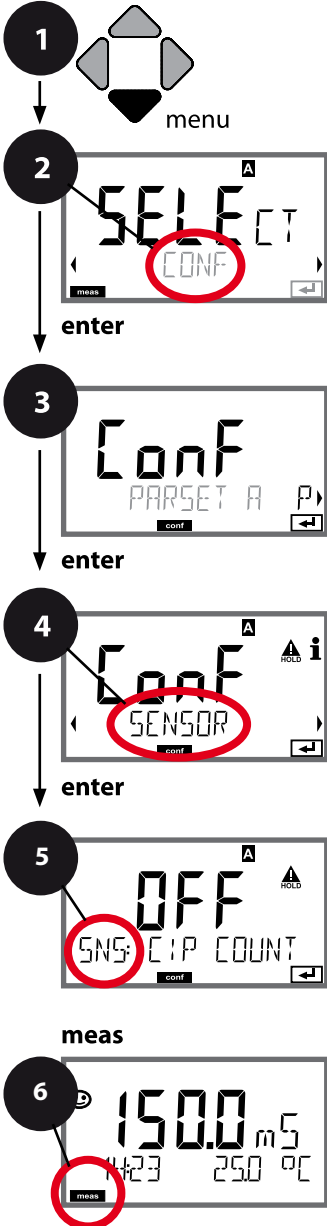

- 1 Press **menu** key.
- 2 Select **CONF** using ◀ ▶, press **enter**.
- 3 Select parameter set using ◀ ▶ keys, press **enter**.
- 4 Select **SENSOR** menu using ◀ ▶ keys, press **enter**.
- 5 All items of this menu group are indicated by the "SNS:" code. Press **enter** to select menu, edit using arrow keys (see next page). Confirm (and proceed) by pressing **enter**.
- 6 Exit: Press **meas** key until the [meas] mode indicator is displayed.

Select sensor type	5	enter
Enter cell constant		↪
Select measuring mode		↪
Select measuring range		
Concentration determination		
Temperature unit		
Temperature detection		
Select type of temp probe		
Cleaning cycles		
Sterilization cycles		
CHECK TAG		
CHECK GROUP		

5

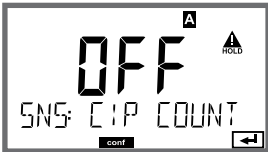
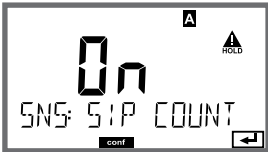
Menu item	Action	Choices
CIP / SIP		
Cleaning cycles on/off 	Select ON or OFF using ▲ ▼ keys. Activates/deactivates logging in extended logbook Press enter to confirm.	ON/OFF
Sterilization cycles on/off 	Select ON or OFF using ▲ ▼ keys. Activates/deactivates logging in extended logbook Press enter to confirm.	ON/OFF

The cleaning and sterilization cycles are logged to measure the load on the sensor. Suitable for biochemical applications (process temperature approx. 0 ... +50 °C / +32 ... +122 °F, CIP temperature > +55 °C / +131 °F, SIP temperature > +115 °C / +239 °F).

Note:

A CIP or SIP cycle is only entered into the logbook 2 hours after the start to ensure that the cycle is complete.

With Memosens sensors, an entry is also made in the sensor.

CondI

Sensor, Sensor Verification (TAG, GROUP)

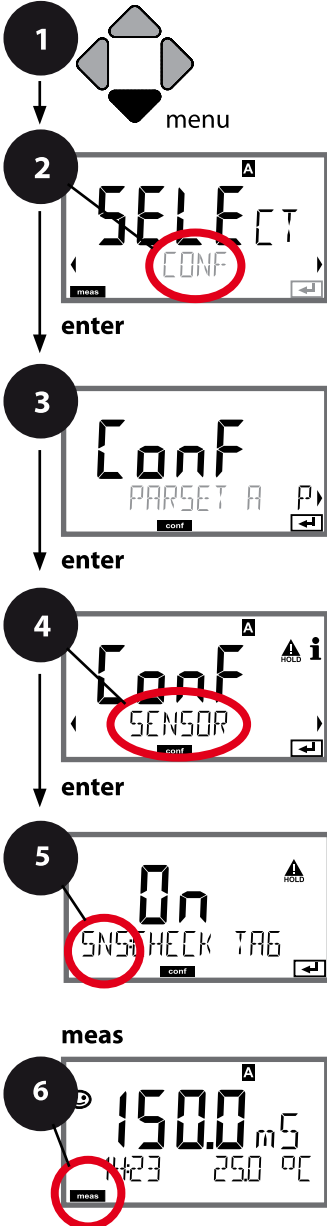

- 1 Press **menu** key.
- 2 Select **CONF** using ◀ ▶ , press **enter**.
- 3 Select parameter set using ◀ ▶ keys, press **enter**.
- 4 Select **SENSOR** menu using ◀ ▶ keys, press **enter**.
- 5 All items of this menu group are indicated by the "SNS:" code.
Press **enter** to select menu, edit using arrow keys (see next page). Confirm (and proceed) by pressing **enter**.
- 6 Exit: Press **meas** key until the [meas] mode indicator is displayed.

5

Select sensor type	enter ↩ ↩ ↩ ↩
Enter cell constant	
Select measuring mode	
Select measuring range	
Concentration determination	
Temperature unit	
Temperature detection	
Select type of temp probe	
Cleaning cycles	
Sterilization cycles	
CHECK TAG	
CHECK GROUP	

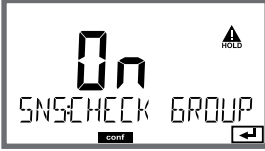
Menu item	Action	Choices
<p>TAG</p> 	<p>Select ON or OFF using ▲ ▼ keys. Press enter to confirm.</p> <p>When switched on, the entry for "TAG" in the Memosens sensor is compared to the entry in the analyzer. If the entries differ, a message will be generated.</p>	<p>ON/OFF</p>
<p>GROUP</p> 	<p>Select ON or OFF using ▲ ▼ keys. Press enter to confirm.</p> <p>Function as described above</p>	<p>ON/OFF</p>

Sensor Verification (TAG, GROUP)

When Memosens sensors are calibrated in the lab, it is often useful and sometimes even mandatory that these sensors will be operated again at the same measuring points or at a defined group of measuring points. To ensure this, you can save the respective measuring point (TAG) or group of measuring points (GROUP) in the sensor. TAG and GROUP can be specified by the calibration tool or automatically entered by the transmitter. When connecting an MS sensor to the transmitter, it can be checked if the sensor contains the correct TAG or belongs to the correct GROUP. If not, a message will be generated, Sensoface gets "sad", and the display backlighting turns magenta (purple). The "sad" Sensoface icon can also be signaled by a 22 mA error current. Sensor verification can be switched on in the Configuration in two steps as TAG and GROUP if required.

When no measuring point or group of measuring points is saved in the sensor, e.g., when using a new sensor, Stratos enters its own TAG and GROUP. When sensor verification is switched off, Stratos always enters its own measuring point and group. A possibly existing TAG/GROUP will be overwritten.

Overview of Condl Sensor Configuration

Condl Sensor		Choices	Default
SNS:		SE 655 SE 656 SE 660 SE 670 SE 680-K, SE 680-M, MEMOSENS, OTHER	SE 655
OTHER	RTD TYPE	100PT / 1000PT / 30 NTC	1000PT
	CELL FACTOR	XX.XXx	01.980
	TRANS RATIO	XXX.Xx	120.0
MEAS MODE		Cond Conc % Sal ‰	Cond
Cond	MEAS RANGE	xxx.x μS/cm x.xxx mS/cm xx.xx mS/cm xxx.x mS/cm x.xxx S/m xx.xx S/m	x.xxx mS/cm
Conc	Solution	-01- (NaCl) -02- (HCl) -03- (NaOH) -04- (H2SO4) -05- (HNO3) -06- (H2SO4) -07- (HCl) -08- (HNO3) -09- (H2SO4) -10- (NaOH) -11-(H ₂ SO ₄ •SO ₃) (oleum)	-01- (NaCl)
TEMP UNIT		°C / °F	°C

Condl

Device Type: Condl

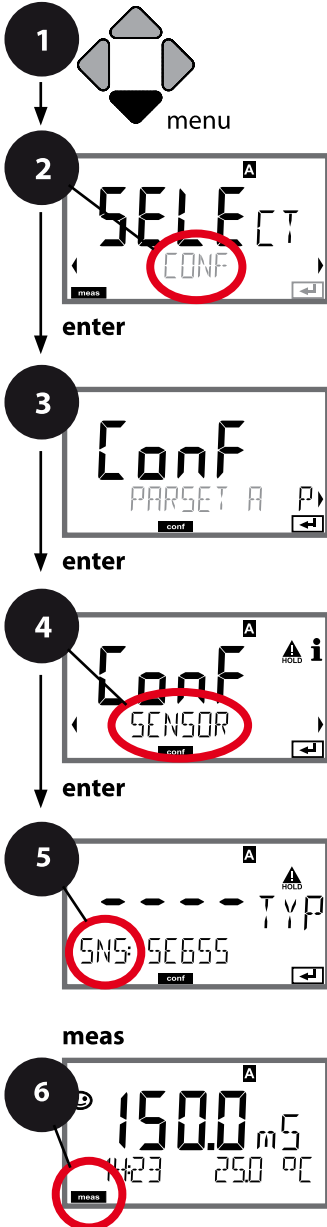

Connected modules are automatically recognized. In the SERVICE menu you can change the device type. Afterwards, you must select the corresponding calibration mode in the CONF menu.



- 1 Press **menu** key.
- 2 Select **CONF** using ◀ ▶, press **enter**.
- 3 Select parameter set using ◀ ▶ keys, press **enter**.
- 4 Select **SENSOR** menu using ◀ ▶ keys, press **enter**.
- 5 All items of this menu group are indicated by the "SNS:" code. Press **enter** to select menu, edit using arrow keys (see next page). Confirm (and proceed) by pressing **enter**.
- 6 Exit: Press **meas** key until the [meas] mode indicator is displayed.

5	Sensor type	enter
	Temperature probe	↩
	Cell factor	↩
	Transfer ratio	
	Measuring mode	
	Measuring range	
	Concentration determination	
	Temperature unit	
	Cleaning cycles	
	Sterilization cycles	
	CHECK TAG	
	CHECK GROUP	

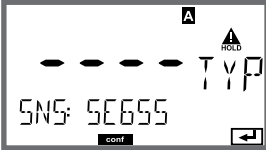
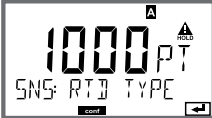
5

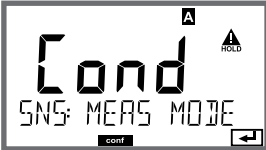
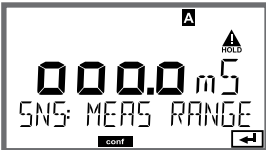
Menu item	Action	Choices
<p>Sensor type</p> 	<p>Select sensor type using \blacktriangle \blacktriangledown keys.</p> <p>Press enter to confirm.</p>	<p>SE 655 SE 656 SE 660 SE 670 SE680-K SE 680-M MEMOSENS OTHER</p>
<p>Temperature probe</p>  <p>Cell factor</p>  <p>Transfer ratio</p> 	<p>Only with OTHER: Select type of temperature probe using \blacktriangle \blacktriangledown keys. Press enter to confirm.</p> <p>Enter cell factor using \blacktriangle \blacktriangledown \blacktriangleleft \blacktriangleright keys. Press enter to confirm.</p> <p>Enter transfer ratio using \blacktriangle \blacktriangledown \blacktriangleleft \blacktriangleright keys. Press enter to confirm.</p>	<p>1000PT 100PT 30 NTC</p> <p>01.980 XX.XXx</p> <p>120.00 XXX.Xx</p>
<p>Measuring mode</p> 	<p>Select desired mode using \blacktriangle \blacktriangledown keys.</p> <p>Press enter to confirm.</p>	<p>Cond Conc % Sal %</p>
<p>Range</p> 	<p>For cond measurement only</p> <p>Select desired measuring range using \blacktriangle \blacktriangledown keys.</p> <p>Press enter to confirm.</p>	<p>xxx.x μS/cm, x.xxx mS/cm, xx.xx mS/cm xxx.x mS/cm, x.xxx S/m xx.xx S/m</p>

Condl

Sensor, Concentration Determination, Temperature Unit

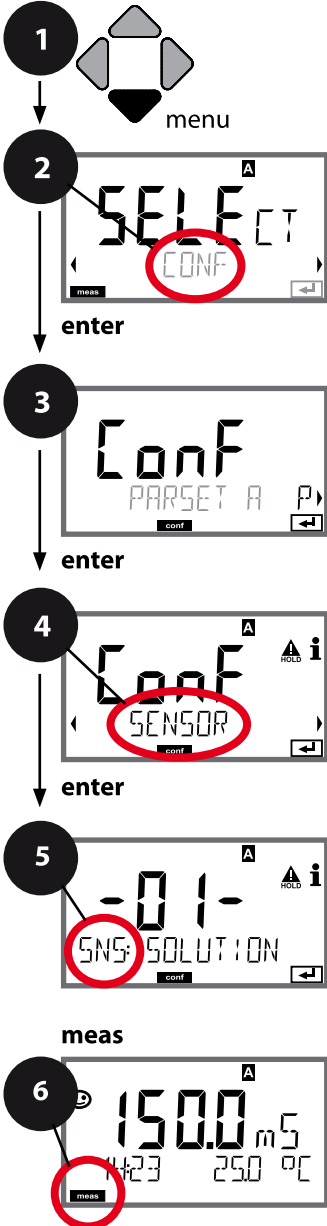

- 1 Press **menu** key.
- 2 Select **CONF** using ◀ ▶, press **enter**.
- 3 Select parameter set using ◀ ▶ keys, press **enter**.
- 4 Select **SENSOR** menu using ◀ ▶ keys, press **enter**.
- 5 All items of this menu group are indicated by the "SNS:" code.
Press **enter** to select menu, edit using arrow keys (see next page). Confirm (and proceed) by pressing **enter**.
- 6 Exit: Press **meas** key until the [meas] mode indicator is displayed.

Sensor type	5	enter
Temperature probe		
Cell factor		
Transfer ratio		
Measuring mode		
Measuring range		
Concentration determination		
Temperature unit		
Cleaning cycles		
Sterilization cycles		
CHECK TAG		
CHECK GROUP		

5

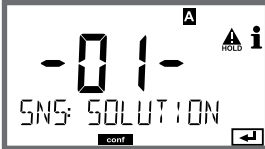
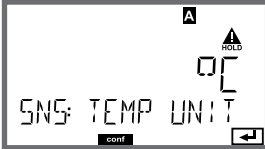
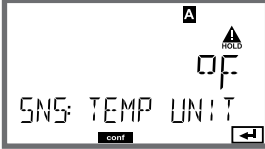
Menu item	Action	Choices
<p>Concentration determination</p> 	<p>For conc measurement only</p> <p>Select desired concentration solution using ▲ ▼ keys (see appendix for ranges).</p> <p>Press enter to confirm.</p>	<ul style="list-style-type: none"> -01- (NaCl) -02- (HCl) -03- (NaOH) -04- (H₂SO₄) -05- (HNO₃) -06- (H₂SO₄) -07- (HCl) -08- (HNO₃) -09- (H₂SO₄) -10- (NaOH) -11- (H₂SO₄·SO₃) (oleum)
<p>Temperature unit</p>  	<p>Select °C or °F using ▲ ▼ keys.</p> <p>Press enter to confirm.</p>	<p>°C / °F</p>

Condl

Sensor, Cleaning Cycles, Sterilization Cycles

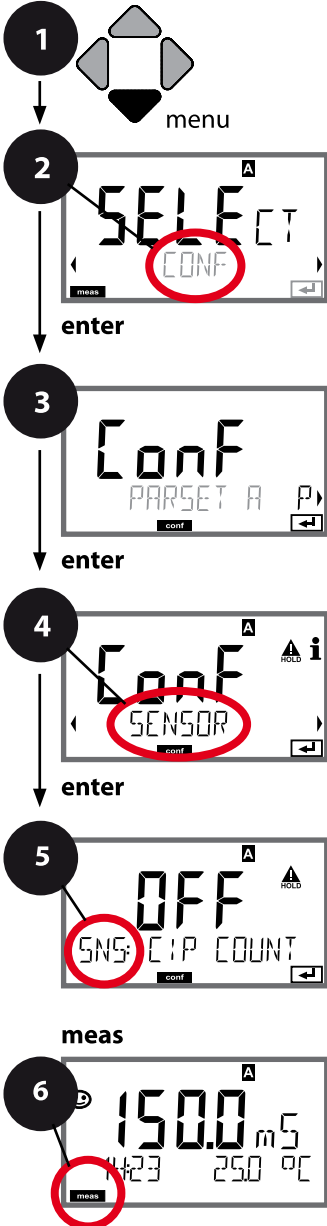

- 1 Press **menu** key.
- 2 Select **CONF** using ◀ ▶, press **enter**.
- 3 Select parameter set using ◀ ▶ keys, press **enter**.
- 4 Select **SENSOR** menu using ◀ ▶ keys, press **enter**.
- 5 All items of this menu group are indicated by the "SNS:" code. Press **enter** to select menu, edit using arrow keys (see next page). Confirm (and proceed) by pressing **enter**.
- 6 Exit: Press **meas** key until the [meas] mode indicator is displayed.

Select sensor type	5	enter
Select temp probe		
Select cell factor		
Select transfer ratio		
Select measuring mode		
Select measuring range		
Concentration determination		
Temperature unit		
Cleaning cycles		
Sterilization cycles		
CHECK TAG		
CHECK GROUP		

5

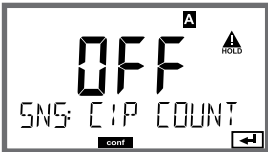
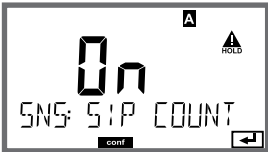
Menu item	Action	Select
CIP / SIP		
Cleaning cycles on/off 	Select ON or OFF using ▲ ▼ keys. Activates/deactivates logging in extended logbook Press enter to confirm.	ON/OFF
Sterilization cycles on/off 	Select ON or OFF using ▲ ▼ keys. Activates/deactivates logging in extended logbook Press enter to confirm.	ON/OFF

The cleaning and sterilization cycles are logged to measure the load on the sensor. Suitable for biochemical applications (process temperature approx. 0 ... +50 °C / +32 ... +122 °F, CIP temperature > +55 °C / +131 °F, SIP temperature > +115 °C / +239 °F).

Note:

A CIP or SIP cycle is only entered into the logbook 2 hours after the start to ensure that the cycle is complete.

With Memosens sensors, an entry is also made in the sensor.

Condl

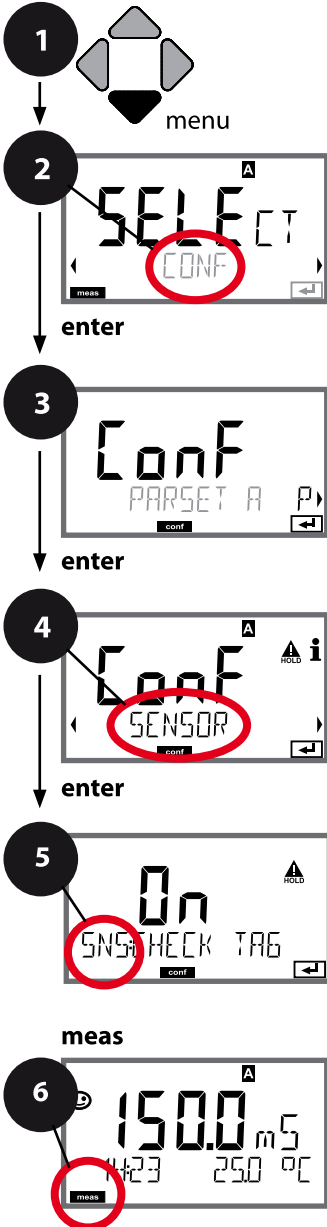

Sensor, Sensor Verification (TAG, GROUP)



- 1 Press **menu** key.
- 2 Select **CONF** using ◀ ▶ , press **enter**.
- 3 Select parameter set using ◀ ▶ keys, press **enter**.
- 4 Select **SENSOR** menu using ◀ ▶ keys, press **enter**.
- 5 All items of this menu group are indicated by the "SNS:" code.
Press **enter** to select menu, edit using arrow keys (see next page). Confirm (and proceed) by pressing **enter**.
- 6 Exit: Press **meas** key until the [meas] mode indicator is displayed.

Select sensor type	5	enter
Select temp probe		
Select cell factor		
Select transfer ratio		
Select measuring mode		
Select measuring range		
Concentration determination		
Temperature unit		
Cleaning cycles		
Sterilization cycles		
CHECK TAG		
CHECK GROUP		

5

Menu item	Action	Choices
<p>TAG</p> 	<p>Select ON or OFF using ▲ ▼ keys. Press enter to confirm.</p> <p>When switched on, the entry for "TAG" in the Memosens sensor is compared to the entry in the analyzer. If the entries differ, a message will be generated.</p>	<p>ON/OFF</p>
<p>GROUP</p> 	<p>Select ON or OFF using ▲ ▼ keys. Press enter to confirm.</p> <p>Function as described above</p>	<p>ON/OFF</p>

Sensor Verification (TAG, GROUP)

When Memosens sensors are calibrated in the lab, it is often useful and sometimes even mandatory that these sensors will be operated again at the same measuring points or at a defined group of measuring points. To ensure this, you can save the respective measuring point (TAG) or group of measuring points (GROUP) in the sensor. TAG and GROUP can be specified by the calibration tool or automatically entered by the transmitter. When connecting an MS sensor to the transmitter, it can be checked if the sensor contains the correct TAG or belongs to the correct GROUP. If not, a message will be generated, Sensoface gets "sad", and the display backlighting turns purple. The "sad" Sensoface icon can also be signaled by a 22 mA error current. Sensor verification can be switched on in the Configuration in two steps as TAG and GROUP if required.

When no measuring point or group of measuring points is saved in the sensor, e.g., when using a new sensor, Stratos enters its own TAG and GROUP. When sensor verification is switched off, Stratos always enters its own measuring point and group. A possibly existing TAG/GROUP will be overwritten.

Cond Cond

Sensors A and B – Arrangement

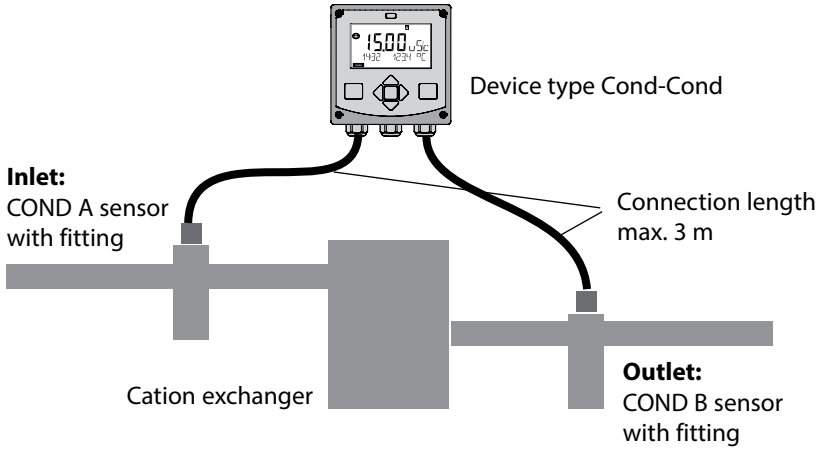

Channel selection and display assignment

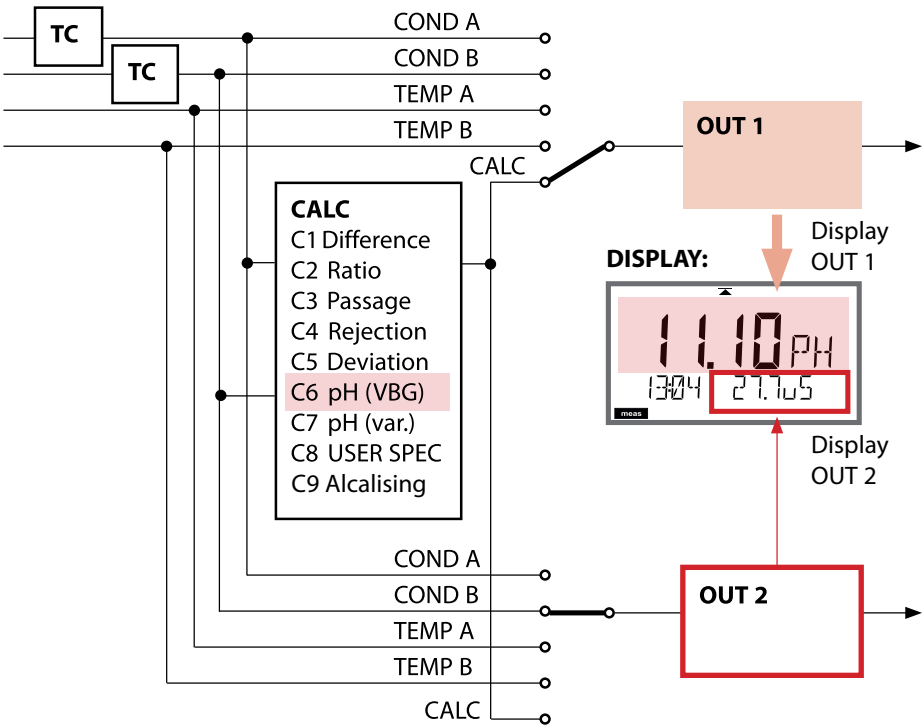

Cond

Cond

Calculations (CALC)

CONF	Calculation	Formula
-C1-	Difference	COND A – COND B
-C2-	Ratio	COND A / COND B
-C3-	Passage	COND B / COND A * 100
-C4-	Rejection	(COND A – COND B) / COND A * 100
-C5-	Deviation	(COND B – COND A) / COND A * 100
-C6- **	pH value acc. to VBG S-006	Additional specifications possible for calculating the consumption of the ion exchanger (size, capacity, efficiency)
	Alkalizing agent NaOH	$11 + \log((\text{COND A} - \text{COND B} / 3) / 243)$
	Alkalizing agent NH3	$11 + \log((\text{COND A} - \text{COND B} / 3) / 273)$
	Alkalizing agent LiOH	$11 + \log((\text{COND A} - \text{COND B} / 3) / 228)$
	EXCHER CAP	ON / OFF Displaying the remaining capacity: Diagnostics / Monitor menu After replacement of the ion exchanger an entry must be made in the SERVICE menu.
	EXCHER SIZE	Input of ion exchanger size
	CAPACITY	Input of ion exchanger capacity
	EFFICIENCY	Input of ion exchanger efficiency
-C7-	Variable pH value, factors specifiable	$C + \log((\text{Cond A} - \text{Cond B} / F1) / F2) / F3$
	COEFFICIENT	Coefficient C
	FACTOR 1	Factor F1
	FACTOR 2	Factor F2
	FACTOR 3	Factor F3

Cond

Cond

-C8-	USER SPEC* (DAC) PARAMETER W, A, B specifiable	
-C9- **	ALCALISING	Concentration of the alcalizing agent selecting NaOH, NH ₃ , LiOH
	nAOH	Concentration calculation
	nH ₃	Concentration calculation
	LiOH	Concentration calculation

*) Input of user-specific parameters possible

***) With C6 and C9, the concentration of the alkalizing agent can be shown in the measurement display and in the sensor monitor and be switched to the current outputs.

Calculating the pH Value by Means of Dual Conductivity Measurement

When monitoring boiler feedwater in power plants, dual conductivity measurement can be used to calculate the pH value. For that purpose, the boiler feedwater conductance is measured before and after the cation exchanger. This commonly used method of indirect pH value measurement does not require much maintenance and has the following advantage:

Normal pH measurement in ultrapure water is very critical. Boiler feed water does not contain many ions. This requires the use of a special electrode, which must be calibrated constantly and the service life of which is generally rather short.

Function

Two sensors are used to measure the conductivity before and after the cation exchanger. The pH value is inferred from these two conductivity values.

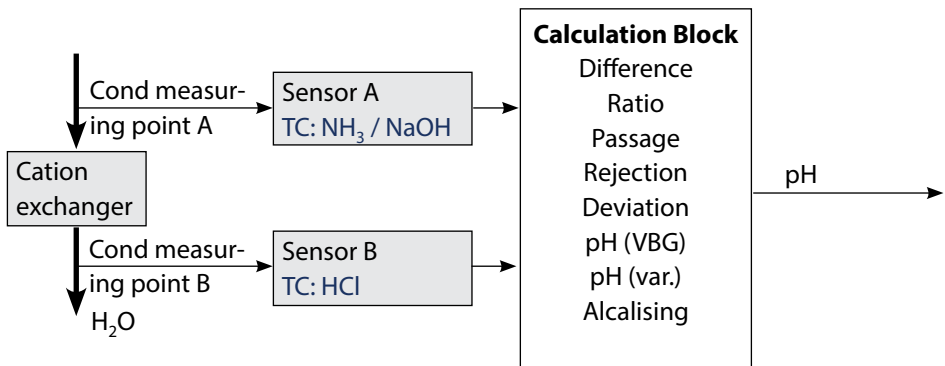

Cond

Cond

Configuration		Select	Default	
SENSOR A				
S_A	CELLFACTOR A ¹⁾		0.0050 ... 1.9999	0.0290
	TC SELECT		OFF LIN, NLF, NaCl HCl, NH3, NaOH	OFF
	LIN	TC LIQUID	00.00 ... +19.99 %/K	00.00 %/K
SENSOR B				
S_B	CELLFACTOR B ¹⁾		0.0050 ... 1.9999	0.0290
	TC SELECT		OFF LIN, NLF, NaCl HCl, NH3, NaOH	OFF
	LIN	TC LIQUID	00.00 ... +19.99 %/K	00.00 %/K
MEAS MODE				
MEAS	MEAS RANGE ²⁾ (this setting applies to both channels, A and B)		0.000 µS/cm 00.00 µS/cm 0.000 µS/cm 0000 µS/cm 00.00 MOhm	00.00 µS/cm
	TEMP UNIT		°C/°F	°C
	CALCULATION		ON/OFF	OFF
	ON	(Selected in text line)	-C1- DIFFERENCE -C2- RATIO -C3- PASSAGE -C4- REJECTION -C5- DEVIATION -C6- PH-VGB -C7- PH-VARIABLE -C8- USER SPEC -C9- ALCALISING	-C1- DIFFERENCE
	-C6-	Alkalizing agent	NaOH, NH3, LiOH	NaOH
		Entries for Calculating the Consumption of the Ion Exchanger		
		EXCHER CAP ³⁾	ON / OFF	OFF
		EXCHER SIZE ³⁾	00.50 ... 5.00 LTR	00.50 LTR
		CAPACITY ³⁾	1.000 ... 5.000 VAL	1.000 VAL
		EFFICIENCY ³⁾	50.00 ... 100.0 %	100.0 %

Cond

Cond

Configuration		Select	Default	
MEAS MODE				
MEAS	-C7-	COEFFICIENT	00.00 ... 99.99	11.00
		FACTOR 1	01.00 ... 10.00	03.00
		FACTOR 2	0100 ... 0500	0243
		FACTOR 3	0.001 ... 9.999	1.000
-C8-	PARAMETER W	xxxx E-3	1000 E-3	
	PARAMETER A	xxx.x E-3	000.0 E-3	
	PARAMETER B	xxx.x E-4	000.0 E-4	
-C9-	ALCALISING	NaOH, NH3, LiOH	NaOH	

- 1) The cell constant can be modified by an entry in the configuration menu or by calibration (one storage position). This means, a cell constant determined by calibration is taken over by pressing **enter** during configuration. It remains unchanged until a new value is entered.
- 2) For conductivity ($\mu\text{S}/\text{cm}$), the range selection determines the max. resolution. If the selected range is exceeded, the device automatically switches to the next higher range until the max. measurement limit is reached (9999 $\mu\text{S}/\text{cm}$). This applies to display values and current outputs. The current outputs are adjusted using a floating-point editor which allows settings over several decades. The initial range of the editor is the selected range:

Selected resolution	Displayed range (or floating-point editor)			
	x.xxx $\mu\text{S}/\text{cm}$	xx.xx $\mu\text{S}/\text{cm}$	x.xxx $\mu\text{S}/\text{cm}$	xxxx $\mu\text{S}/\text{cm}$
x.xxx $\mu\text{S}/\text{cm}$				
xx.xx $\mu\text{S}/\text{cm}$				
xxx.x $\mu\text{S}/\text{cm}$				
xxxx $\mu\text{S}/\text{cm}$				

- 3) Entries for calculating the consumption of the ion exchanger:
 Activate with EXCHER CAP = ON. Messages in the Diagnostics / Monitor menu.

Cond

Device Type: Cond

Cond sensor		Choices	Default
SNS:		2-ELECTRODE 4-ELECTRODE MEMOSENS	2-ELECTRODE
2-EL / 4-EL	CELLFACTOR ¹⁾	00.0000 - 19.9999 c	01.0000 c
MEAS MODE		Cond Conc % Sal ‰ USP µS/cm	Cond
Cond	MEAS RANGE ²⁾	x.xxx µS/cm xx.xx µS/cm xxx.x µS/cm xxxx µS/cm x.xxx mS/cm xx.xx mS/cm xxx.x mS/cm x.xxx S/m xx.xx S/m xx.xx MΩ	xxx.x mS/cm
Conc	Solution	-01- (NaCl) -02- (HCl) -03- (NaOH) -04- (H2SO4) -05- (HNO3) -06- (H2SO4) -07- (HCl) -08- (HNO3) -09- (H2SO4) -10- (NaOH) -11- H ₂ SO ₄ •SO ₃ (oleum)	-01- (NaCl)
TEMP UNIT		°C / °F	°C
TEMPERATURE (EXT. only with I-input enabled via TAN)		AUTO MAN EXT (only if enabled via TAN)	AUTO
AUTO	RTD TYPE	100 PT 1000 PT 8.55 NTC 30 NTC Ni100	100 PT
MAN	TEMPERATURE	-50 ... 250 °C (-58 ... 482 °F)	025.0 °C (077.0 °F)

Device Type: Condl

Condl Sensor		Choices	Default
SNS:		SE 655, SE 656, SE 660, SE 670, SE 680-K, SE 680-M, MEMOSENS, OTHER	SE 655
OTHER	RTD TYPE	100PT / 1000PT / 30 NTC	1000PT
	CELL FACTOR	XX.XXx	01.980
	TRANS RATIO	XXX.Xx	120.0
MEAS MODE		Cond Conc % Sal ‰	Cond
Cond	MEAS RANGE	xxx.x µS/cm x.xxx mS/cm xx.xx mS/cm xxx.x mS/cm x.xxx S/m xx.xx S/m	x.xxx mS/cm
Conc	Solution	-01- (NaCl) -02- (HCl) -03- (NaOH) -04- (H2SO4) -05- (HNO3) -06- (H2SO4) -07- (HCl) -08- (HNO3) -09- (H2SO4) -10- (NaOH) -11- (H ₂ SO ₄ +SO ₃) (Oleum)	-01- (NaCl)
TEMP UNIT		°C / °F	°C
CHECK TAG		ON / OFF	OFF
CHECK GROUP		ON / OFF	OFF

- 1) With Memosens, the cell constant is automatically loaded from the sensor. When switching from Memosens to 2-/4-electrode sensor, the cell constant is set to the default value 01.0000 c and then must be entered manually.
- 2) The range selection allows selecting the maximum resolution. If the upper limit of this range is exceeded, the device automatically switches to the next higher range.

Configuration (default in bold print)				
Current output 1		Cond		
OT1:	RANGE	4 ... 20 mA 0 ... 20 mA		
	CHANNEL	COND , CONC, SAL, USP TMP		
	OUTPUT (Current output curve)	LIN / BILIN / LOG (LOG for S/cm and S/m only)		
	LIN	BEGIN 0/4 mA	Floating-point input, 000.0 mS/c	
		END 20 mA	Floating-point input, 100.0 mS/c	
	LOG	BEGIN 0/4 mA	Selectable decades: S/cm: 1.0 $\mu\text{S}/\text{cm}^*$ / 10.0 $\mu\text{S}/\text{c}^*$ / 100.0 $\mu\text{S}/\text{c}^*$ / 1.0 mS/c / 10.0 mS/c / 100.0 mS/c / 1000 mS/c S/m: 0.001 S/m / 0.01 S/m / 0.1 S/m / 1.0 S/m / 10.0 S/m / 100 S/m	
		END 20 mA	Decades (see above) 100.0 mS/c	
	BI LIN	BEGIN 0/4 mA	Range depending on selected channel	
		END 20 mA	Range depending on selected channel	
		CORNER X	Conditions for bilinear characteristic: Vertex X: $\text{BEGIN} \leq \text{CORNER X} \leq \text{END}$ (rising) $\text{BEGIN} \geq \text{CORNER X} \geq \text{END}$ (falling)	
		CORNER Y	Default: 12 mA Vertex Y: (0 mA) $4 \text{ mA} \leq \text{CORNER Y} \leq 20 \text{ mA}$	
	TMP °C	BEGIN 0/4 mA	- 50 ... 250 °C (000.0 °C)	
		END 20 mA	- 50 ... 250 °C (100.0 °C)	
	TMP °F	BEGIN 0/4 mA	- 58 ... 482 °F (032.0 °F)	
		END 20 mA	- 58 ... 482 °F (212.0 °F)	
	FILTERTIME		0...120 SEC	0000 SEC
	22mA-FAIL		ON/OFF	OFF
	HOLD MODE		LAST/FIX	LAST
	FIX	HOLD-FIX	(0) 4...22 mA	021.0 mA

* not for toroidal conductivity sensors

Configuration (default in bold print)

Current output 2

Default setting CHANNEL: TMP (other settings like OT1)

Correction			Cond		
COR:	TC SELECT		OFF LIN, NLF, NaCl Compensation for ultrapure water: NaCl, HCL, NH3, NaOH		
	LIN	TC LIQUID	00.00 ... 19.99 %/K (00.00 %/K)		
		REF TEMP	000.0 ... 199.9 °C (025.0 °C)		
	EXT	I-INPUT	0–20 mA / 4–20 mA	4...20 mA	
	I-INPUT	°C	BEGIN 4 mA	–50...250 °C	000.0 °C
			END 20 mA	–50...250 °C	100.0 °C
		°F	BEGIN 4 mA	–58...482 °F	
			END 20 mA	–58...482 °F	

* not for toroidal conductivity sensors

Configuration (default in bold print)		
CNTR_IN input		
IN:	CONTROL	PARSET / FLOW
	FLOW	FLOW ADJUST
0 ... 20000 pulses/liter (12000 pulses/liter)		
Alarm		
ALA:	DELAYTIME	0 ... 600 s (0010 SEC)
	SENSOCHECK	ON / OFF
	TEMP CHECK	ON / OFF
	FLOW CNTR ^{*)}	ON / OFF
	ON	FLOW MIN ^{*)}
	FLOW MAX ^{*)}	0 ... 99.9 Liter/h (025.0 Liter/h)
Relay contacts REL1, REL2		
REL:	LIMITS CONTROLLER	The following submenu depends on the selected setting.
RL1:	CHANNEL	COND , CONC, SAL, USP, TMP
	FUNCTION	Lo LEVEL / Hi LEVEL
	CONTACT	N/O / N/C
	LEVEL	000.0 mS/cm
	HYSTERESIS	005.0 mS/cm 0 ... 50 % full scale
	DELAYTIME	0010 SEC 0000 ... 9999 s
RL2:	See RL1 for configuration; default setting: CHANNEL = TMP	
USP function		
USP:	USP FACTOR	010.0 ... 100.0 %
	CONTACT REL1	N/O , N/C
	DELAYTIME	0000 ...9999 SEC
	CONTACT REL2	N/O , N/C
	DELAYTIME	0000 ...9999 SEC

Monitoring the sensor lines for breakage

The sensor lines are monitored for breakage when the temperature is used for calculating the conductivity or concentration. If the sensor or line is broken, an alarm will be generated (output current FIX or 22 mA, depending on the configuration). If you want to output a conductivity value that is independent of the measured temperature (uncompensated), you can monitor the sensor lines for breakage by setting "TEMP CHECK" to "ON" in the Alarm menu.

Configuration (default in bold print)		
PID controller		Cond
CTR:	CHANNEL	COND / TMP
	TYPE	PLC / PFC
	PLC	00001 ... 0600 s (0010 SEC)
	PFC	0001 ... 0180 min ⁻¹ (0060 min⁻¹)
	SETPOINT	within measuring range
	DEAD BAND	0 ... 50 % full scale
	P-GAIN	10 ... 999 % (0100 %)
	I-TIME	0 ... 9999 s (0000 SEC)
	D-TIME	0 ... 9999 s (0000 SEC)
HOLD MODE	Y LAST / Y OFF	
Rinse contact WASH		
WSH:	WASH / PARSET A/B	Rinse contact / Signaling the active parameter set
	WASH CYCLE	0.0 ... 999.9 h (000.0 h)
	WASH TIME	0 ... 1999 s (0060 SEC)
	CONTACT	N/O / N/C
Selecting the parameter set PARSET		
PAR:	PARSET FIX A MANUAL CNTR INPUT	(no switchover, parameter set A) (manual selection in the "Configuration" menu) (switchover via CNTR control input)
Time/date		
CLK	FORMAT	24 h / 12 h
	24 h	hh:mm
	12 h	hh:mm (AM / PM) 00 ... 12:59 AM / 1 ... 11:59 PM
	DAY / MONTH	dd.mm
	YEAR	2000 ... 2099
Measuring points (TAG / GROUP)		
TAG	The entries are made in the text line.	A...Z, 0...9, - + < > ? / @
GROUP	The entries are made in the text line.	0000...9999

* These menu items appear only if selected.

** Hysteresis fixed at 5% of threshold value



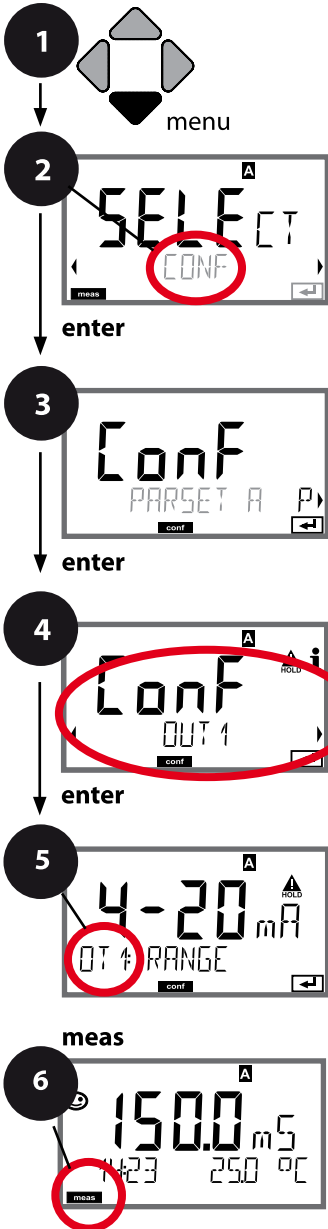

Output Current, Range, Current Start, Current End

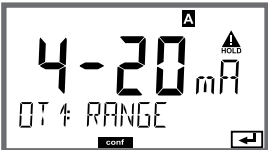

- 1 Press **menu** key.
- 2 Select **CONF** using $\leftarrow \rightarrow$, press **enter**.
- 3 Select parameter set using $\leftarrow \rightarrow$ keys, press **enter**.
- 4 Select **OUT1** menu using $\leftarrow \rightarrow$ keys, press **enter**.
- 5 All items of this menu group are indicated by the "OT1:" code. Press **enter** to select menu, edit using arrow keys (see next page). Confirm (and proceed) by pressing **enter**.
- 6 Exit: Press **meas** key until the [meas] mode indicator is displayed.

5	Current range	enter
	Process variable	↔
	Current start	↔
	Current end	
	Time averaging filter	
	Output current during error message	
	Output current for Sensoface message	
	Output current during HOLD	
	Output current for HOLD FIX	

5

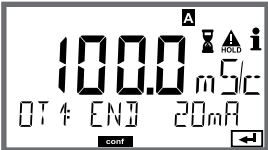
Menu item	Action	Select
<p>Current range</p> 	<p>Select 4-20 mA or 0-20 mA range using \blacktriangle \blacktriangledown keys.</p> <p>Press enter to confirm.</p>	<p>4-20 mA / 0-20 mA</p>
<p>Process variable</p> 	<p>Select using \blacktriangle \blacktriangledown keys.</p> <p>Cond: Conductivity TMP: Temperature</p> <p>Press enter to confirm.</p> <p>Then select characteristic (LIN/biLIN/LOG).</p>	<p>Cond/TMP</p> 
<p>Current start</p> 	<p>Modify digit using \blacktriangle \blacktriangledown keys, select next digit using \blacktriangleleft \blacktriangleright keys.</p> <p>Press enter to confirm.</p>	<p>Entered value applies to selected process variable/range.</p> <p>If the adjusted range is exceeded, the device automatically switches to the next higher range (Autorange)</p>
<p>Current end</p> 	<p>Enter value using \blacktriangle \blacktriangledown \blacktriangleleft \blacktriangleright keys.</p> <p>Press enter to confirm.</p>	<p>Entered value applies to selected process variable/range.</p> <p>If the adjusted range is exceeded, the device automatically switches to the next higher range (Autorange)</p>

Assignment of measured values: Current start and current end

Example 1: Measuring range 0 ... 200 mS/cm

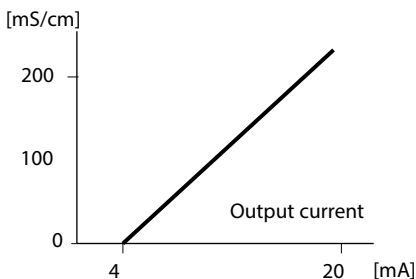

Example 2: Measuring range 100 ... 200 mS/cm
Advantage: Higher resolution in range of interest

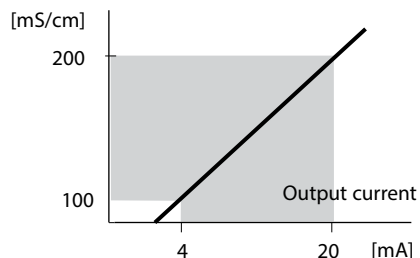

Output Current, Characteristic

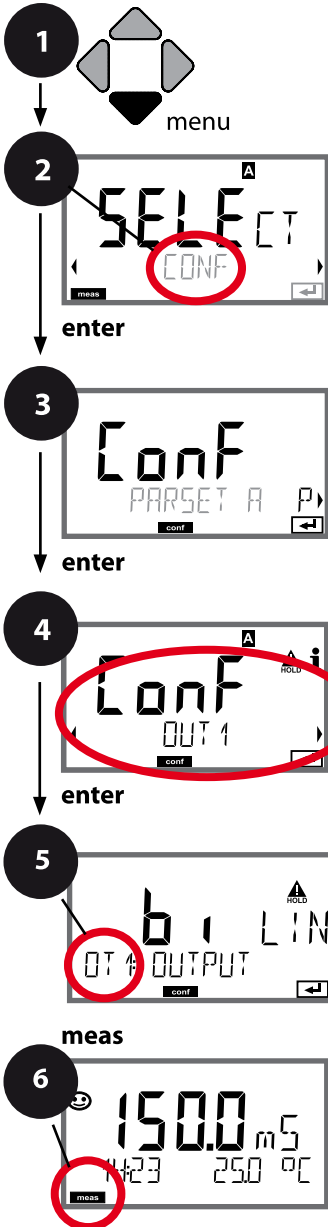



- 1 Press **menu** key.
- 2 Select **CONF** using ◀ ▶, press **enter**.
- 3 Select parameter set using ◀ ▶ keys, press **enter**.
- 4 Select **OUT1** menu using ◀ ▶ keys, press **enter**.
- 5 All items of this menu group are indicated by the "OT1:" code.
Press **enter** to select menu, edit using arrow keys (see next page). Confirm (and proceed) by pressing **enter**.
- 6 Exit: Press **meas** key until the [meas] mode indicator is displayed.

5

Current range	enter
Process variable	
LIN/biLIN/LOG output	enter
Current start	
Current end	
Bilinear: Vertex X	
Bilinear: Vertex Y	
Time averaging filter	
Output current during error message	
Output current for Sensoface message	
Output current during HOLD	
Output current for HOLD FIX	

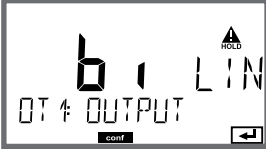
5

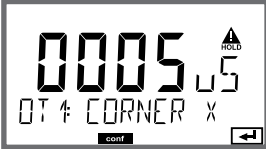
Menu item	Action	Select
Output current curve 	Select using \uparrow \downarrow keys, confirm by pressing enter	LIN Linear characteristic biLIN Bilinear curve LOG Logarithmic curve
Current start and current end 	Enter value using \uparrow \downarrow \leftarrow \rightarrow keys. Press enter to confirm.	Entered value applies to selected process variable/range. If the adjusted range is exceeded, the device automatically switches to the next higher range (Autorange)
Bilinear curve: Vertex X/Y 	Enter value using \uparrow \downarrow \leftarrow \rightarrow keys. Press enter to confirm.	Entered value applies to selected vertex of bilinear curve "Corner X" (process variable) and "Corner Y" (output current) – see figure below.

Vertex of bilinear curve

Output current

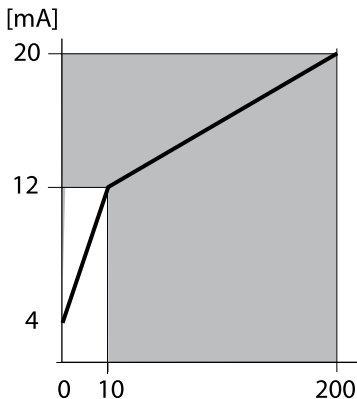

Example:

Current range 4 ... 20 mA,

Current start: 0 $\mu\text{S/cm}$

Current end: 200 $\mu\text{S/cm}$

Vertex:

"CORNER X": 10 $\mu\text{S/cm}$ (process variable)

"CORNER Y": 12 mA (output current)

Result: The output current change in the range 0 ... 10 $\mu\text{S/cm}$ is much greater than in the range 10 ... 200 $\mu\text{S/cm}$.

Process variable
[$\mu\text{S/cm}$]

Output Current, Logarithmic Curve

Nonlinear output current characteristic: allows measurements over several decades, e.g., measuring very low values with a high resolution and high values with a low resolution.

Parameters required: Start and end value

Possible start and end values

The start value must be at least one decade lower than the end value. Start value and end value must be specified in the same units (either in $\mu\text{S/cm}$ or in S/m , see listing):

1.0 $\mu\text{S/cm}$	
10.0 $\mu\text{S/cm}$	0.001 S/cm
100.0 $\mu\text{S/cm}$	0.01 S/cm
1.0 mS/cm	0.1 S/cm
10.0 mS/cm	1.0 S/cm
100.0 mS/cm	10.0 S/cm
1000 mS/cm	100 S/cm

The start value

is the next decade value below the lowest measured value.

The end value

is the next decade value above the highest measured value.

The number of decades results from:

Number of decades = $\log(\text{end value}) - \log(\text{start value})$

The output current value is defined as follows:

$$\text{Output current} = 16 \text{ mA} * \frac{\log(\text{measured value}) - \log(\text{start value})}{\text{Number of decades}} + 4 \text{ mA}$$

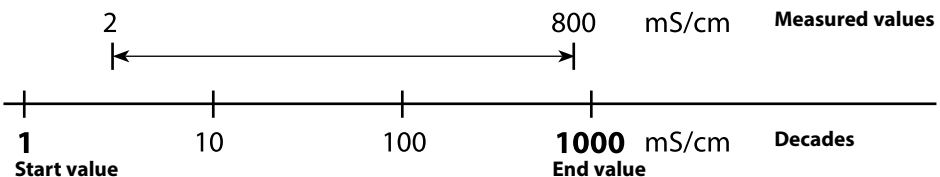

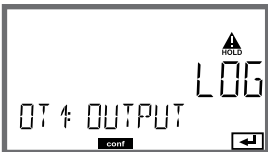
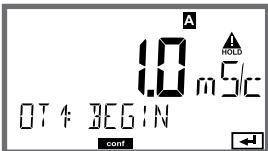
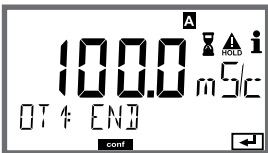
Menu item	Action	Select
Logarithmic curve Output current 	Select using \uparrow \downarrow keys, confirm by pressing enter	LOG Logarithmic curve biLIN Bilinear curve LIN Linear characteristic
Start value 	Enter value using \uparrow \downarrow \leftarrow \rightarrow keys. Press enter to confirm.	Start value of logarithmic output curve
End value 	Enter value using \uparrow \downarrow \leftarrow \rightarrow keys. Press enter to confirm.	End value of logarithmic output curve

Possible start and end values for the logarithmic curve

S/cm:

1.0 μ S/cm, 10.0 μ S/cm, 100.0 μ S/cm,
 1.0 mS/cm, 10.0 mS/cm, 100.0 mS/cm, 1000 mS/cm

S/m:

0.001 S/m, 0.01 S/m, 0.1 S/m, 1.0 S/m, 10.0 S/m, 100 S/m

Output Current, Time Averaging Filter

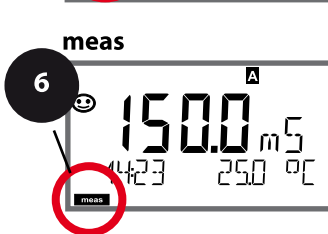

- 1 Press **menu** key.
- 2 Select **CONF** using $\leftarrow \rightarrow$, press **enter**.
- 3 Select parameter set using $\leftarrow \rightarrow$ keys, press **enter**.
- 4 Select **OUT1** menu using $\leftarrow \rightarrow$ keys, press **enter**.
- 5 All items of this menu group are indicated by the "OT1:" code.
Press **enter** to select menu, edit using arrow keys (see next page). Confirm (and proceed) by pressing **enter**.
- 6 Exit: Press **meas** key until the [meas] mode indicator is displayed.

5

Current range	enter
Process variable	enter
Current start	enter
Current end	
Time averaging filter	
Output current during error message	
Output current for Sensoface message	
Output current during HOLD	
Output current for HOLD FIX	

5

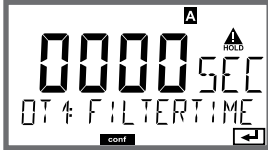
Menu item	Action	Select
Time averaging filter 	Enter value using ▲ ▼ ◀ ▶ keys. Press enter to confirm.	0...120 SEC (0000 SEC)

Time averaging filter

To smoothen the current output, a low-pass filter with adjustable filter time constant can be switched on. When there is a jump at the input (100 %), the output level is at 63 % after the time interval has been reached. The time interval can be set from 0 to 120 sec. If the time interval is set to 0 sec, the current output directly follows the input.

Note:

The filter only acts on the current output, not on the display, the limit values, or the controller!

During HOLD the filter is not applied. This prevents a jump at the output.

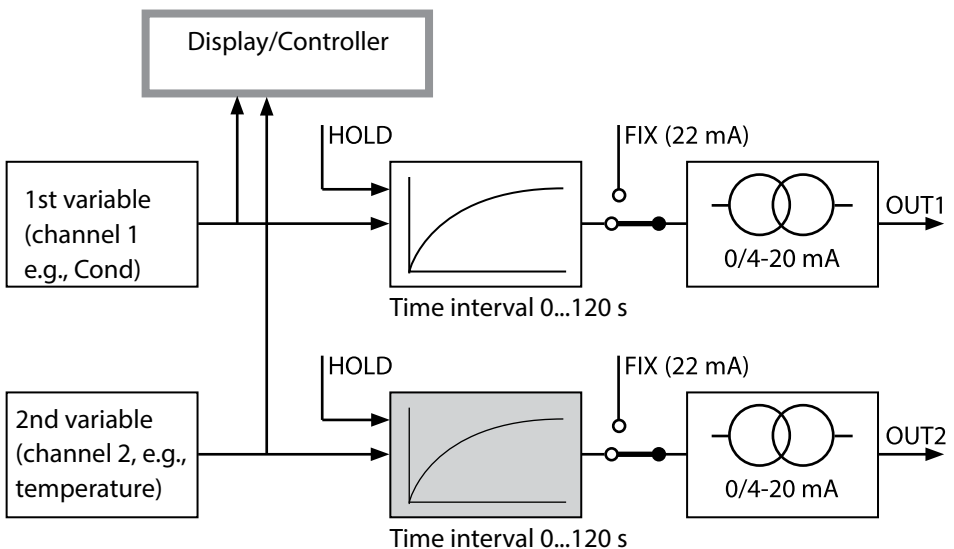

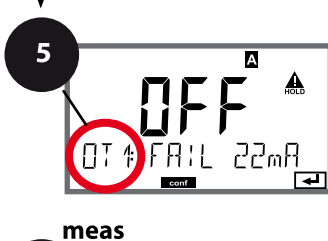
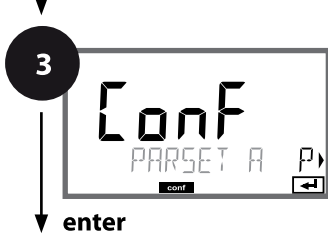

Output Current, Error and HOLD

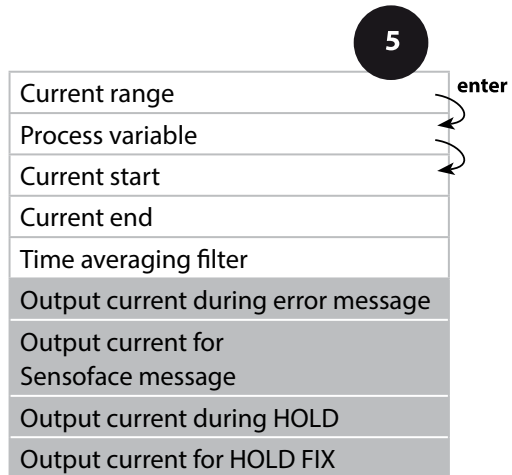

- 1 Press **menu** key.
- 2 Select **CONF** using $\leftarrow \rightarrow$, press **enter**.
- 3 Select parameter set using $\leftarrow \rightarrow$ keys, press **enter**.
- 4 Select **OUT1** menu using $\leftarrow \rightarrow$ keys, press **enter**.
- 5 All items of this menu group are indicated by the "OT1:" code. Press **enter** to select menu, edit using arrow keys (see next page). Confirm (and proceed) by pressing **enter**.
- 6 Exit: Press **meas** key until the [meas] mode indicator is displayed.

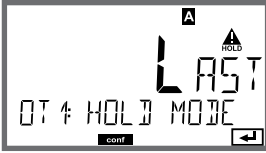

5

Menu item	Action	Choices
Output current during error message 	The output current can be set to 22 mA in the case of error messages. Select ON or OFF using \blacktriangle \blacktriangledown . Press enter to confirm.	OFF / ON
Output current during Sensoface messages OT1: FACE 22 mA	The output current can be set to 22 mA in the case of Sensoface messages. Select ON or OFF using \blacktriangle \blacktriangledown . Press enter to confirm.	OFF / ON
Output current during HOLD 	LAST: During HOLD the last measured value is maintained at the output. FIX: During HOLD a value (to be entered) is maintained at the output. Select using \blacktriangle \blacktriangledown . Press enter to confirm.	LAST/FIX
Output current for HOLD FIX 	Only with FIX selected: Enter current which is to flow at the output during HOLD Enter value using \blacktriangle \blacktriangledown \blacktriangleleft \blacktriangleright . Press enter to confirm.	00.00...22.00 mA (21.00 mA)

Output signal during HOLD:

Output current [mA]

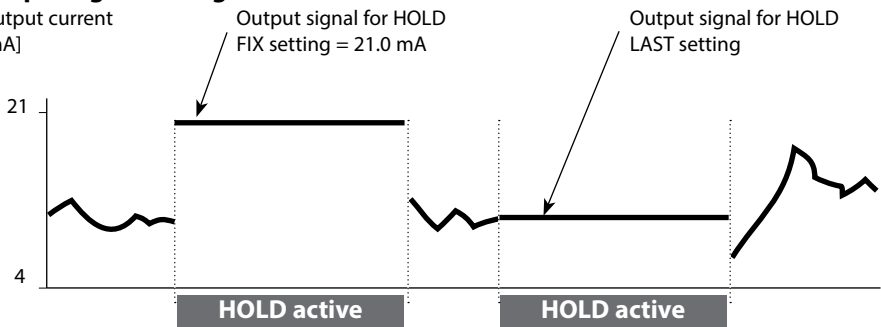

Temperature Compensation

Selecting the compensation method

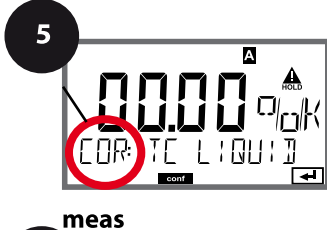
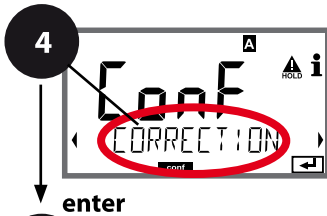
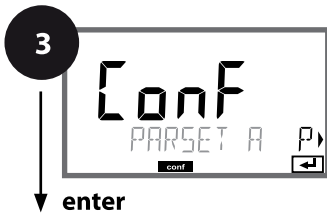

- 1 Press **menu** key.
- 2 Select **CONF** using ◀ ▶ , press **enter**.
- 3 Select parameter set using ◀ ▶ keys, press **enter**.
- 4 Select **CORRECTION** menu using ◀ ▶ keys, press **enter**.
- 5 All items of this menu group are indicated by the "COR:" code. Confirm (and proceed) by pressing **enter**.
- 6 Exit: Press **meas** key until the [meas] mode indicator is displayed.

5





Temperature compensation

Temperature compensation
of process medium

Enter reference temperature

enter

5

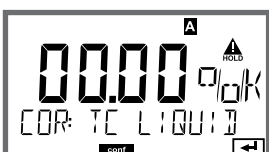
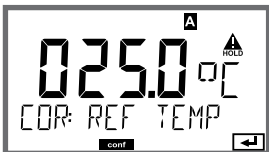
Menu item	Action	Choices
Temperature compensation	Select desired compensation using ▲ ▼ keys: OFF: Temperature compensation switched off	
	LIN: Linear temperature compensation with entry of temperature coefficient and reference temperature	
	nLF: Temperature compensation for natural waters to EN 27888	
	NaCl, HCL, NH3, NaOH: Ultrapure water with traces of impurity (0 ... +120 °C / +32 ... +248 °F)	
Temperature compensation of process medium	With linear compensation only: Step 1: Enter temperature compensation of the process medium.	
Enter reference temperature	Step 2: Enter reference temperature Enter value using ▲ ▼ ◀ ▶ keys Press enter to confirm. Permissible range 0 ... 199.9 °C	

Parameter Set Selection (External Signal)

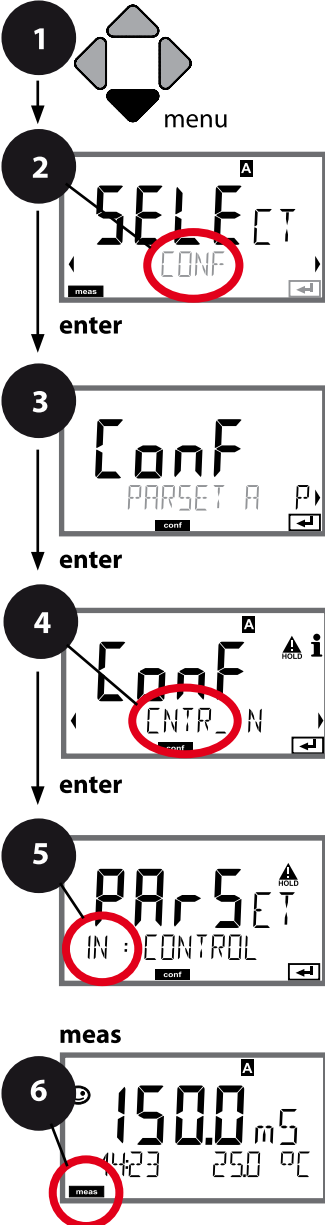

- 1 Press **menu** key.
- 2 Select **CONF** using ◀ ▶, press **enter**.
- 3 Select parameter set A using ◀ ▶ keys, press **enter**.
- 4 Select **CNTR_IN** menu using ◀ ▶ keys, press **enter**.
- 5 All items of this menu group are indicated by the "IN:" code. Press **enter** to select menu, edit using arrow keys (see next page). Confirm (and proceed) by pressing **enter**.
- 6 Exit: Press **meas** key until the [meas] mode indicator is displayed.

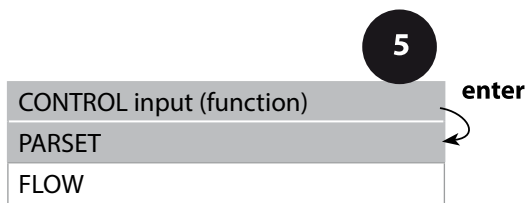

5

Menu item	Action	Select
Select function of CONTROL input 	Select using ◀ ▶ keys, confirm by pressing enter	PARSET FIX A / MANUAL / CNTR INPUT (selecting parameter set A/B via signal at CONTROL input)

External switchover of parameter sets

The parameter set A/B can be activated from outside by sending a signal to the CONTROL input (e.g., from the process control system).

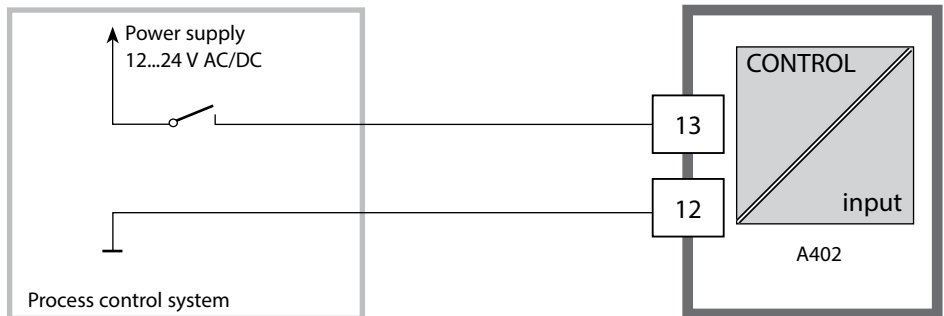

Parameter set A	0...2 V AC/DC
Parameter set B	10...30 V AC/DC

Flow Measurement

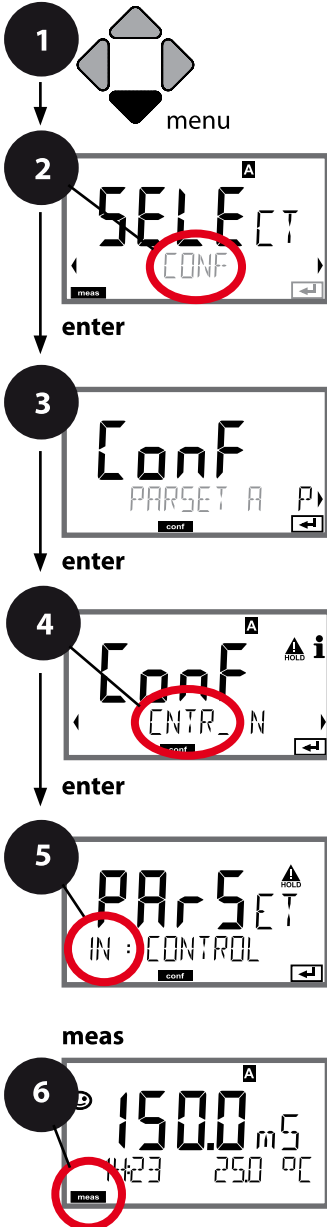



- 1 Press **menu** key.
- 2 Select **CONF** using ◀ ▶ , press **enter**.
- 3 Select parameter set A using ◀ ▶ keys, press **enter**.
- 4 Select **CNTR_IN** menu using ◀ ▶ keys, press **enter**.
- 5 All items of this menu group are indicated by the "IN:" code. Press **enter** to select menu, edit using arrow keys (see next page). Confirm (and proceed) by pressing **enter**.
- 6 Exit: Press **meas** key until the [meas] mode indicator is displayed.

5

CONTROL input (function)	enter
PARSET / FLOW	
FLOW: ADJUST	

5

Menu item	Action	Select
Select function of CONTROL input 	Select using ▲ ▼ keys, confirm by pressing enter	PARSET (selecting parameter set A/B via signal at CONTROL input)
		Flow (for connecting a pulse-output flow meter)
Adjust to flow meter: 	With "Flow" selected, you must adjust the device to the flow meter used. Enter value using arrow keys, confirm by pressing enter	12000 pulses/liter

In the alarm menu you can configure flow monitoring.

When you have set CONTROL to FLOW, you can specify 2 additional limit values for maximum and minimum flow. If the measured value lies outside this range, an alarm message and a 22-mA error signal (if configured) will be generated.

Note: The response speed may be reduced because the values are averaged.

Display

Flow measurement in measuring mode



Display

Flow measurement (sensor monitor)



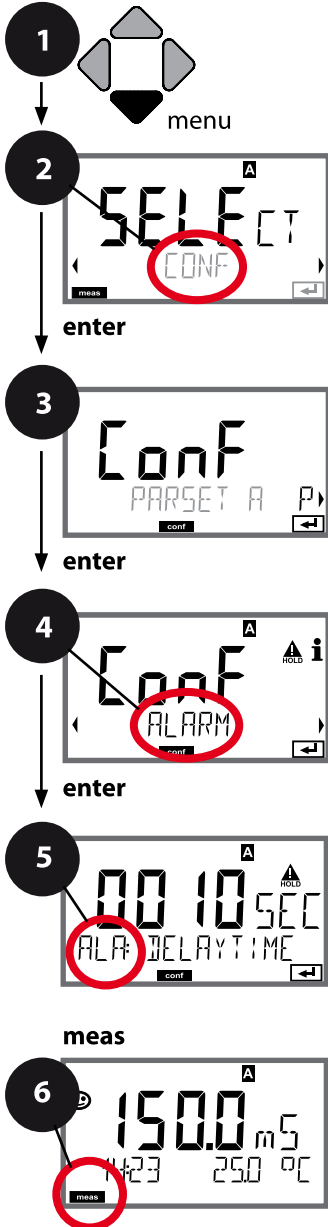

Alarm, Alarm Delay, Sensocheck, Tempcheck



- 1 Press **menu** key.
- 2 Select **CONF** using ◀ ▶, press **enter**.
- 3 Select parameter set using ◀ ▶ keys, press **enter**.
- 4 Select **ALARM** menu using ◀ ▶ keys, press **enter**.
- 5 All items of this menu group are indicated by the "ALA:" code.
Press **enter** to select menu, edit using arrow keys (see next page). Confirm (and proceed) by pressing **enter**.
- 6 Exit: Press **meas** key until the [meas] mode indicator is displayed.

Alarm: Delay	5	enter
Alarm: Sensocheck		↻
Alarm: Tempcheck		
Alarm: CONTROL input		
With flow monitoring: Max. flow alarm		
With flow monitoring: Min. flow alarm		

5

Menu item	Action	Choices
Alarm delay 	Enter alarm delay using ▲ ▼ ◀ ▶ keys. Press enter to confirm.	0...600 SEC (010 SEC)
Sensocheck 	Select Sensocheck (continuous monitoring of lines). Select ON or OFF using ▲ ▼ keys. Press enter to confirm. (At the same time, Sensoface is activated. With OFF, Sensoface is also switched off.)	ON/OFF
Tempcheck (see page 90)	To monitor the temperature probe with TC OFF selected: Select Tempcheck ON using ▲ ▼ keys. Press enter to confirm. Now, the temperature probe will be monitored.	ON/OFF

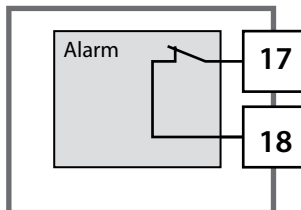

Alarm Contact

The alarm contact is closed during normal operation (N/C). It opens in the case of alarm or power outage. As a result, a failure message is output even in the case of line breakage (fail-safe behavior). For contact ratings, see Specifications.

Error messages can also be signaled by a 22-mA output current (see Error messages and Configuration Output 1/Output 2).

Operating behavior of the alarm contact: see Operating States table.

The alarm delay time delays the color change of the display backlighting to red, the 22-mA signal (if configured), and the alarm contact switching.

Alarm, CONTROL Input (FLOW MIN, FLOW MAX)

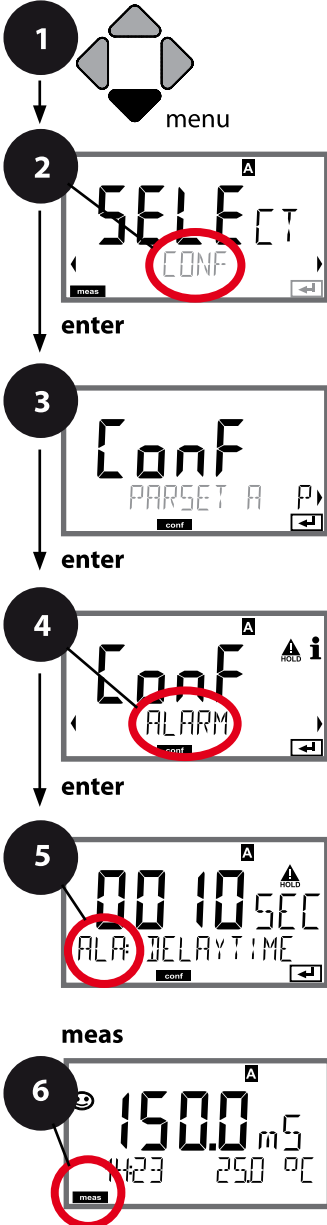

- 1 Press **menu** key.
- 2 Select **CONF** using ◀ ▶, press **enter**.
- 3 Select parameter set using ◀ ▶ keys, press **enter**.
- 4 Select **ALARM** menu using ◀ ▶ keys, press **enter**.
- 5 All items of this menu group are indicated by the "ALA:" code. Press **enter** to select menu, edit using arrow keys (see next page). Confirm (and proceed) by pressing **enter**.
- 6 Exit: Press **meas** key until the [meas] mode indicator is displayed.

5

Alarm: Delay	enter
Alarm: Sensocheck	↩
Alarm: CONTROL input	
With flow monitoring: Max. flow alarm	
With flow monitoring: Min. flow alarm	

5

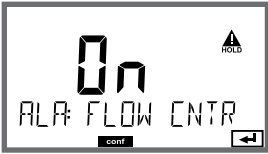
Menu item	Action	Select
CONTROL input 	The CONTROL input can generate an alarm when assigned to "FLOW" (flow monitoring) in the CONF menu: FLOW CNTR Flow measurement: allows monitoring the minimum and maximum flow (pulse counter)	ON/OFF (FLOW MIN, FLOW MAX.)
Alarm Minimum flow FLOW MIN	Specify value	Default: 05.00 liters/h
Alarm Maximum flow FLOW MAX	Specify value	Default: 25.00 liters/h



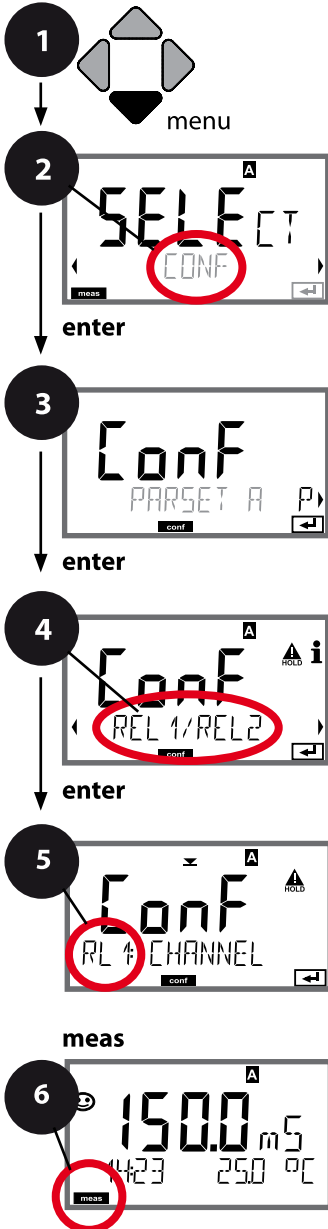

Limit Function, Relay 1

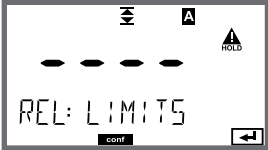

- 1 Press **menu** key.
- 2 Select **CONF** using $\leftarrow \rightarrow$, press **enter**.
- 3 Select parameter set using $\leftarrow \rightarrow$, press **enter**.
- 4 Select **REL1/REL2** menu using $\leftarrow \rightarrow$ keys, press **enter**.
- 5 All items of this menu group are indicated by the "RL1:" code.
Press **enter** to select menu, edit using arrow keys (see next page). Confirm (and proceed) by pressing **enter**.
- 6 Exit: Press **meas** key until the [meas] mode indicator is displayed.

5	Use of relays	enter
	Select process variable	enter
	Limit 1 switching characteristics (function)	enter
	Limit 1 contact type	
	Limit 1 setpoint	
	Limit 1 hysteresis	
	Limit 1 delay	

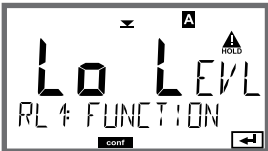
5

Menu item	Action	Select
<p>Use of relays</p> 	<p>Select in the text line using ▲ ▼ keys:</p> <ul style="list-style-type: none"> • Limit function (LIMITS) • Controller (CONTROLLER) • USP function (USP) <p>Press enter to confirm.</p>	<p>LIMITS / CONTROLLER (not with MQ as process variable!) / USP FUNCT (only with USP selected!).</p> <p>Note: Selecting CONTROLLER leads to Controller menu group (CTR), selecting USP FUNCT to USP function menu group.</p>
<p>Select process variable</p> 	<p>Select desired process variable using ▲ ▼ keys.</p> <p>Press enter to confirm.</p>	<p>Depending on module or Memosens sensor</p>
<p>Limit 1 function</p> 	<p>Select desired function using arrow keys.</p> <p>LoLevel: active if value falls below setpoint LoLevel: active if value exceeds setpoint</p> <p>Press enter to confirm.</p>	<p>Lo LEVEL / Hi LEVEL</p> <p>Limit 1 icon: ▼</p>
<p>Limit 1 contact response</p> 	<p>N/O: normally open contact N/C: normally closed contact</p> <p>Select using ▲ ▼ keys.</p> <p>Press enter to confirm.</p>	<p>N/O / N/C</p>
<p>Limit 1 setpoint</p> 	<p>Enter setpoint using ▲ ▼ ◀ ▶ keys.</p> <p>Press enter to confirm.</p>	<p>Depending on module or Memosens sensor</p>

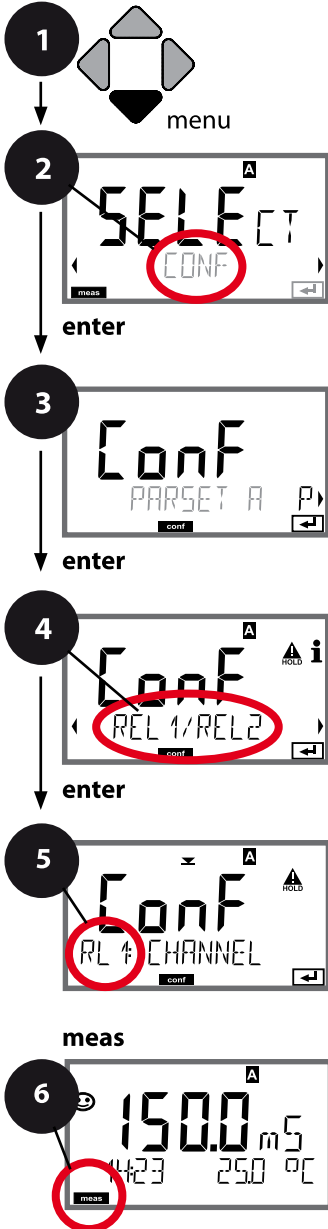

Limit Function, Relay 1

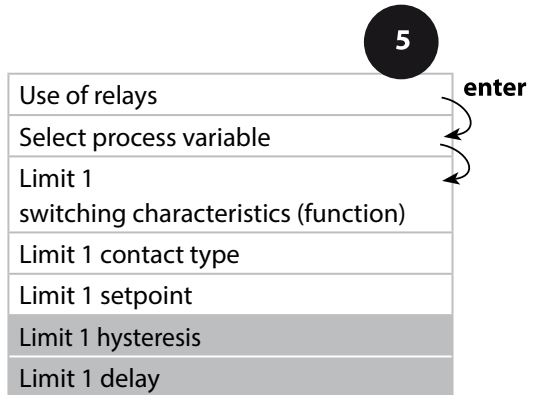

- 1 Press **menu** key.
- 2 Select **CONF** using ◀ ▶, press **enter**.
- 3 Select parameter set using ◀ ▶ keys, press **enter**.
- 4 Select **REL1/REL2** menu using ◀ ▶ keys, press **enter**.
- 5 All items of this menu group are indicated by the "RL1:" code. Press **enter** to select menu, edit using arrow keys (see next page). Confirm (and proceed) by pressing **enter**.
- 6 Exit: Press **meas** key until the [meas] mode indicator is displayed.

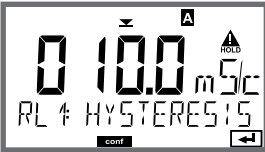

5

Menu item	Action	Select
Limit 1 hysteresis 	Select hysteresis using ▲ ▼ ◀ ▶ keys. Press enter to confirm.	Depending on module or Memosens sensor
Limit 1 delay 	The contact is activated with delay (deactivated without delay) Adjust delay using ▲ ▼ ◀ ▶ keys. Press enter to confirm.	0...9999 SEC (0010 SEC)

Application of Hysteresis:

Limit Lo

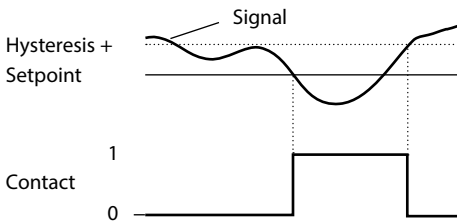

Limit Hi

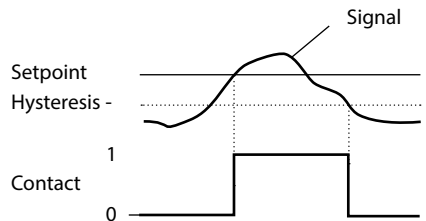

Limit Function, Relay 2

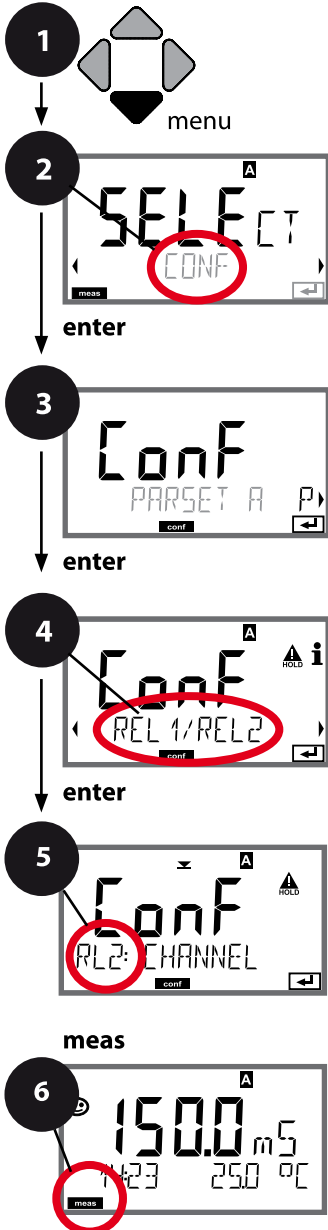

- 1 Press **menu** key.
- 2 Select **CONF** using ◀ ▶, press **enter**.
- 3 Select parameter set using ◀ ▶ keys, press **enter**.
- 4 Select **REL1/REL2** menu using ◀ ▶ keys, press **enter**.
- 5 All items of this menu group are indicated by the "RL2:" code.
Press **enter** to select menu, edit using arrow keys (see next page). Confirm (and proceed) by pressing **enter**.
- 6 Exit: Press **meas** key until the [meas] mode indicator is displayed.

5

Use of relays

Select process variable

Limit 2 switching characteristics (function)

Limit 2 contact type

Limit 2 setpoint

Limit 2 hysteresis

Limit 2 delay

enter

5

Menu item	Action	Select
Select process variable (CHANNEL)	Select desired process variable using \blacktriangle \blacktriangledown keys. Press enter to confirm.	Depending on module or Memosens sensor
Limit 2 function (FUNCTION)	Select desired function using arrow keys. Press enter to confirm.	Lo LEVEL / Hi LEVEL Limit 2 icon: \blacktriangle
Limit 2 contact type (CONTACT)	N/O: normally open contact N/C: normally closed contact Select using \blacktriangle \blacktriangledown keys. Press enter to confirm.	N/O / N/C
Limit 2 setpoint (LEVEL)	Enter setpoint using \blacktriangle \blacktriangledown \blacktriangleleft \blacktriangleright keys. Press enter to confirm.	Depending on module or Memosens sensor
Limit 2 hysteresis (HYSTERESIS)	Select hysteresis using \blacktriangle \blacktriangledown \blacktriangleleft \blacktriangleright keys. Press enter to confirm.	Depending on module or Memosens sensor
Limit 2 delay (DELAYTIME)	The contact is activated with delay (deactivated without delay) Adjust delay using \blacktriangle \blacktriangledown \blacktriangleleft \blacktriangleright keys. Press enter to confirm.	0...9999 SEC (0010 SEC)

Application of Hysteresis:

Limit Lo

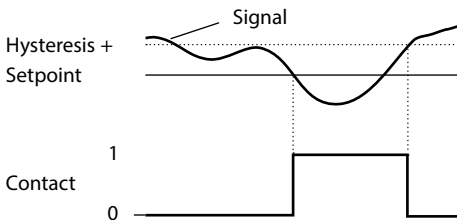

Limit Hi

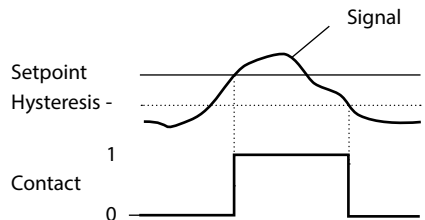

Protective Wiring of Relay Contacts

Relay contacts are subject to electrical erosion. Especially with inductive and capacitive loads, the service life of the contacts will be reduced. For suppression of sparks and arcing, components such as RC combinations, nonlinear resistors, series resistors and diodes should be used.

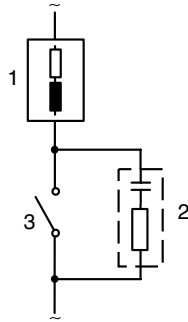
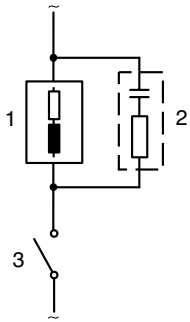

Typical AC applications with inductive load

- 1 Load
- 2 RC combination,
e.g., RIFA PMR 209
Typical RC combinations for
230 V AC:
capacitor 0.1 μF / 630 V,
resistor 100 Ω / 1 W
- 3 Contact

Typical Protective Wiring Measures

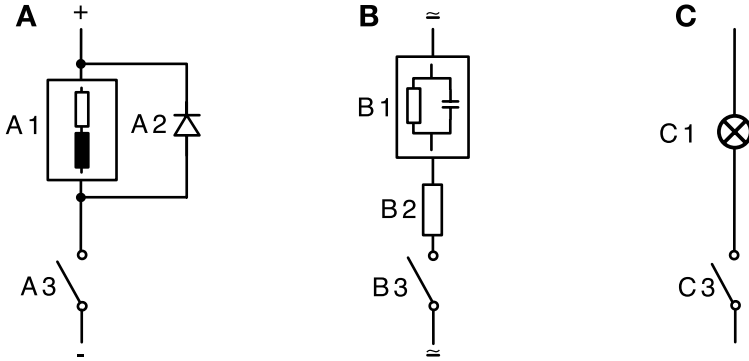

- A:** DC application with inductive load
- B:** AC/DC applications with capacitive load
- C:** Connection of incandescent lamps

- A1 Inductive load
- A2 Free-wheeling diode, e.g., 1N4007 (Observe polarity)
- A3 Contact
- B1 Capacitive load
- B1 Resistor, e.g., $8 \Omega / 1 \text{ W}$ at $24 \text{ V} / 0.3 \text{ A}$
- B3 Contact
- C1 Incandescent lamp, max $60 \text{ W} / 230 \text{ V}$, $30 \text{ W} / 115 \text{ V}$
- C3 Contact



WARNING!

Make sure that the maximum ratings of the relay contacts are not exceeded even during switching!

Typical Applications

P controller

Application for integrating control systems (e.g., closed tank, batch processes).

PI controller

Application for non-integrating control systems (e.g., drains).

PID controller

The additional derivative action compensates for measurement peaks.

Controller Characteristic

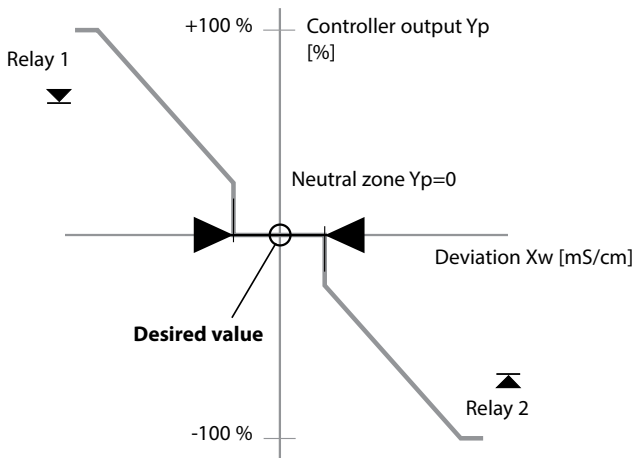

Controller Equations

$$\text{Controller output } Y = \underbrace{Y_P}_{\text{P action}} + \underbrace{\frac{1}{T_R} \int Y_P dt}_{\text{I action}} + \underbrace{T_D \frac{dY_P}{dt}}_{\text{D action}}$$

Proportional action Y_P

with:

- Y_P Proportional action
- T_N Reset time [s]
- T_D Rate time [s]
- K_C Controller gain [%]

$$Y_P = \frac{\text{Setpoint} - \text{Meas. value}}{\text{Measuring range}} * K_C$$

Neutral Zone (Y=0)

Tolerated deviation from setpoint.
 With the setting "1 mS/cm", for example, a deviation of ± 0.5 mS/cm from the setpoint does not activate the controller.

Proportional Action (Gradient K_C [%])

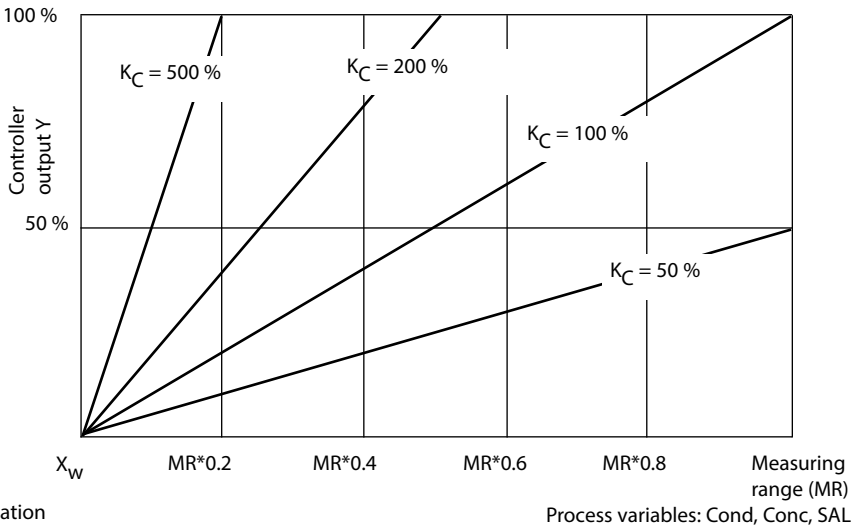

Pulse Length / Pulse Frequency Controller

Pulse Length Controller (PLC)

The pulse length controller is used to operate a valve as an actuator. It switches the contact on for a time that depends on the controller output. The period is constant. A minimum ON time of 0.5 sec is maintained even if the controller output takes corresponding values.

Output signal (relay contact) of pulse length controller

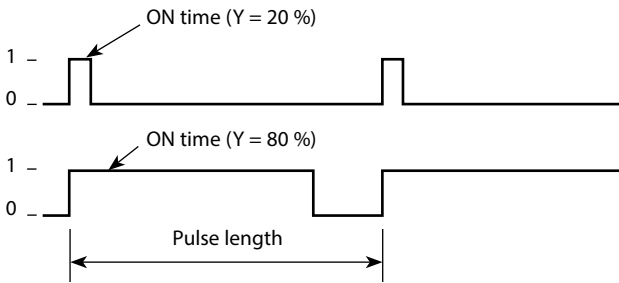

Pulse Frequency Controller (PFC)

The pulse frequency controller is used to operate a frequency-controlled actuator (metering pump). It varies the frequency with which the contacts are switched on. The maximum pulse frequency [pulses/min] can be defined. It depends on the actuator.

The contact ON time is constant. It is automatically calculated from the user-defined maximum pulse frequency:

Output signal (relay contact) of pulse frequency controller

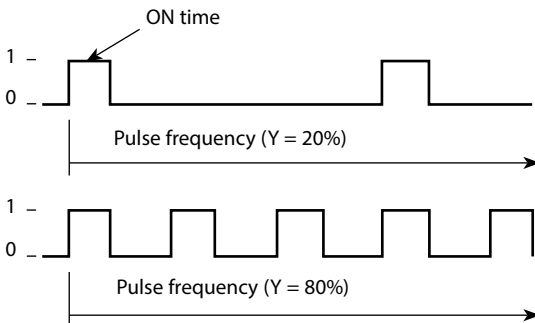

PID controller and behavior during HOLD

The following setting can be made for the controller: HOLD MODE = Y LAST/Y OFF.

Y LAST: The controller output Y is maintained during HOLD

Y OFF: Y = 0 during HOLD (no control)

For a continuous (non-integrating) process, you should use the Y LAST setting.

For an integrating process (closed boiler), you should use Y OFF.

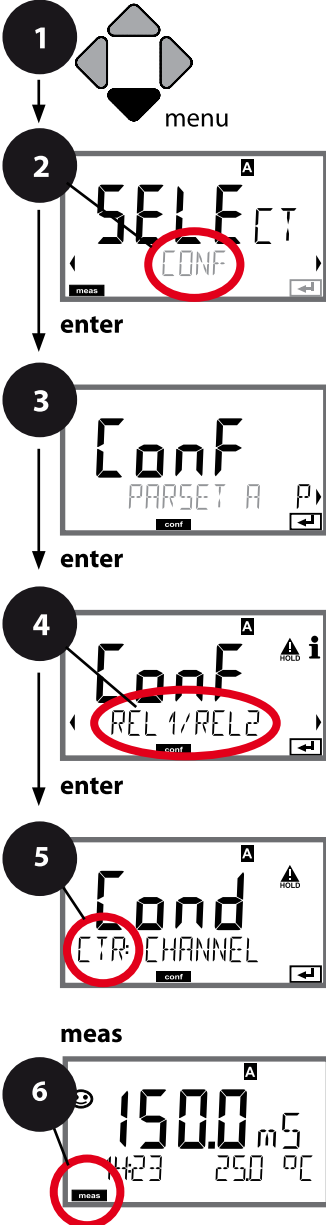

Controller, Process Variable, Controller Type, Setpoint



- 1 Press **menu** key.
- 2 Select **CONF** using ◀ ▶, press **enter**.
- 3 Select parameter set using ◀ ▶ keys, press **enter**.
- 4 Select **REL1/REL2** menu using ◀ ▶ keys, press **enter**.
- 5 All items of this menu group are indicated by the "CTR:" code. Press **enter** to select menu, edit using arrow keys (see next page). Confirm (and proceed) by pressing **enter**.
- 6 Exit: Press **meas** key until the [meas] mode indicator is displayed.

5	Use of relays	enter
	Select process variable	↩
	Controller type	↩
	Pulse length	
	Pulse frequency	
	Setpoint	
	Neutral zone	
	Controller: P action	
	Controller: I action	
	Controller: D action	
	Behavior during HOLD	

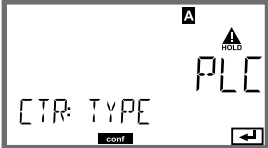
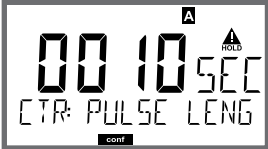
5

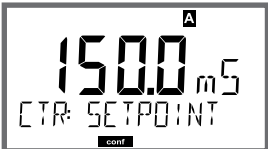
Menu item	Action	Select
Use of relays	Select in the text line using ▲ ▼ keys: • Controller (CONTROLLER) Press enter to confirm.	LIMITS / CONTROLLER Selecting CONTROLLER leads to Controller menu group CTR.
Select process variable 	Select desired process variable using ▲ ▼ keys. Press enter to confirm.	Depending on module or Memosens sensor
Controller type 	Pulse length controller (PLC) or pulse frequency controller (PFC) Select using ▲ ▼ keys. Press enter to confirm.	PLC / PFC
Pulse length 	Only with PLC: Pulse length Adjust using ▲ ▼ ◀ ▶ keys. Press enter to confirm.	0...0600 SEC (0010 SEC)
Pulse frequency 	Only with PFC: Pulse frequency Adjust using ▲ ▼ ◀ ▶ keys. Press enter to confirm.	0...0180 P/M (0060 P/M) (pulses per minute)
Setpoint 	Adjust setpoint using ▲ ▼ ◀ ▶ keys. Press enter to confirm.	Depending on module or Memosens sensor

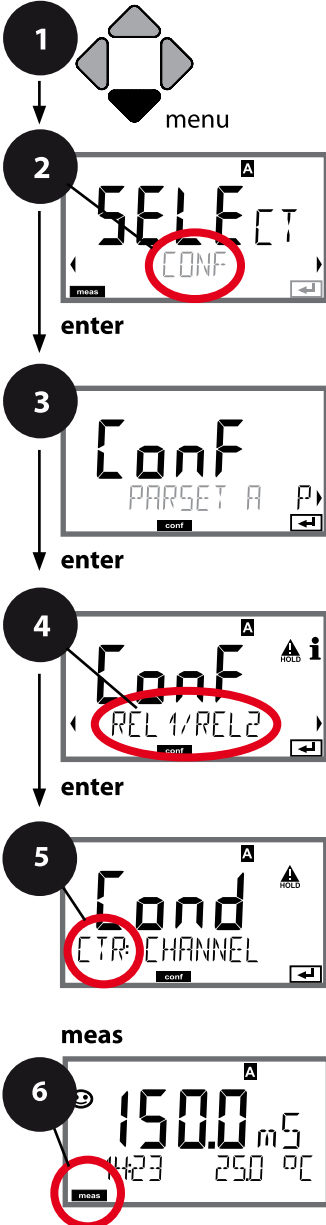

Controller, Neutral Zone, P, I, D Action Components, Behavior during HOLD



- 1 Press **menu** key.
- 2 Select **CONF** using ◀ ▶ , press **enter**.
- 3 Select parameter set using ◀ ▶ keys, press **enter**.
- 4 Select **REL1/REL2** menu using ◀ ▶ keys, press **enter**.
- 5 All items of this menu group are indicated by the "CTR:" code.
Press **enter** to select menu, edit using arrow keys (see next page). Confirm (and proceed) by pressing **enter**.
- 6 Exit: Press **meas** key until the [meas] mode indicator is displayed.

	5	enter
Use of relays		↙
Select process variable		↙
Controller type		↙
Pulse length		
Pulse frequency		
Setpoint		
Neutral zone		
Controller: P action		
Controller: I action		
Controller: D action		
Behavior during HOLD		

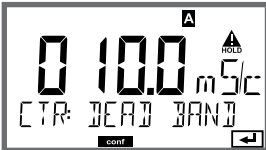
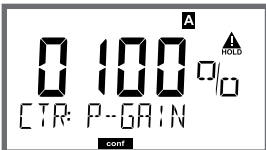
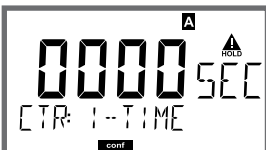
5

Menu item	Action	Select
<p>Neutral zone</p> 	<p>Adjust neutral zone using ▲ ▼ ◀ ▶ keys.</p> <p>Press enter to confirm.</p>	<p>Depending on module or Memosens sensor</p>
<p>Controller: P action</p> 	<p>Adjust P action using ▲ ▼ ◀ ▶ keys.</p> <p>Press enter to confirm.</p>	<p>10...9999% (0100%)</p>
<p>Controller: I action</p> 	<p>Adjust I action using ▲ ▼ ◀ ▶ keys.</p> <p>Press enter to confirm.</p>	<p>0...9999 SEC (0000 SEC)</p>
<p>Controller: D action</p> 	<p>Adjust D action using ▲ ▼ ◀ ▶ keys.</p> <p>Press enter to confirm.</p>	<p>0...9999 SEC (0000 SEC)</p>
<p>Behavior during HOLD*</p> 	<p>Select response using ▲ ▼ keys.</p> <p>Press enter to confirm.</p>	<p>Y LAST / Y OFF Y LAST: The controller output Y is maintained during HOLD Y OFF: Y = 0 during HOLD (no control)</p>

***) PID controller and behavior during HOLD**

For a continuous (non-integrating) process, you should use the Y LAST setting.

For an integrating process (closed boiler), you should use Y OFF.

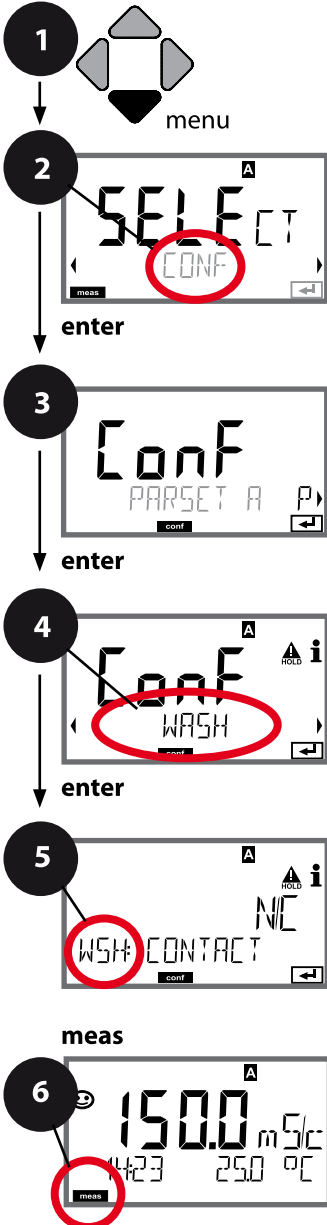

WASH Contact, Controlling a Rinsing Probe or Signaling the Parameter Set



- 1 Press **menu** key.
- 2 Select **CONF** using ◀ ▶, press **enter**.
- 3 Select parameter set A using ◀ ▶ keys, press **enter**.
- 4 Select **WASH** menu using ◀ ▶ keys, press **enter**.
- 5 All items of this menu group are indicated by the "WSH:" code.
Press **enter** to select menu, edit using arrow keys (see next page). Confirm (and proceed) by pressing **enter**.
- 6 Exit: Press **meas** key until the [meas] mode indicator is displayed.

Function	5	enter
Cleaning interval		↻
Cleaning duration		↻
Relax time		
Contact type		

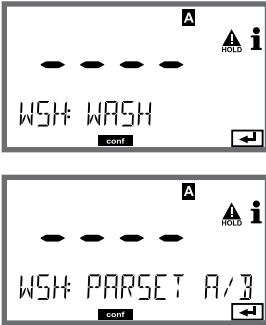
5

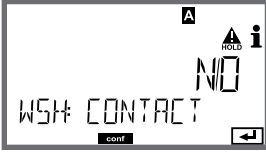
Menu item	Action	Choices
<p>Function</p> 	<p>Select WASH contact function using ▲ ▼ keys.</p> <p>Press enter to confirm.</p>	<p>WASH / PARSET A/B</p> <p>WASH: Controlling a rinsing probe</p> <p>With PARSET A/B selected, the contact signals: "Parameter set A" (open contact) "Parameter set B" (closed contact)</p>
<p>Cleaning interval</p> 	<p>Only with WASH: Adjust value using ▲ ▼ ◀ ▶ keys.</p> <p>Press enter to confirm.</p>	<p>0.0...999.9 h (000.0 h)</p>
<p>Cleaning duration</p> 	<p>Only with WASH: Adjust value using ▲ ▼ ◀ ▶ keys.</p> <p>Press enter to confirm.</p>	<p>0...9999 SEC (0060 SEC)</p> <p>Relax time: 0000...1999 SEC (0030 SEC)</p>
<p>Contact type</p> 	<p>Only with WASH: N/O: normally open contact N/C: normally closed contact Select using ▲ ▼ keys. Press enter to confirm.</p>	<p>N/O / N/C</p>



Time and Date, Measuring Point

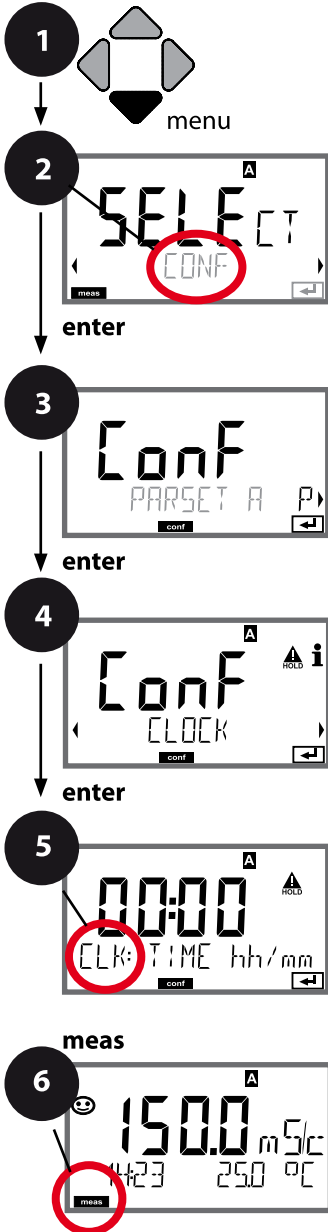

- 1 Press **menu** key.
- 2 Select **CONF** using ◀ ▶, press **enter**.
- 3 Select parameter set A using ◀ ▶ keys, press **enter**.
- 4 Select **CLOCK** or **TAG** using ◀ ▶ keys, press **enter**.
- 5 All items of this menu group are indicated by the "CLK:" or "TAG" code.
Press **enter** to select menu, edit using arrow keys (see next page). Confirm (and proceed) by pressing **enter**.
- 6 Exit: Press **meas** key until the [meas] mode indicator is displayed.

5 enter

Time format
Time
Day and month
Year
TAG of measuring point
GROUP of measuring points

5

Time and Date

Control of the calibration and cleaning cycles is based on the time and date of the integrated real-time clock.

In measuring mode the time is shown in the lower display. When using digital sensors, the calibration data is written in the sensor head. In addition, the logbook entries (cf Diagnostics) are provided with a time stamp.

Note:

There is no automatic switchover from winter to summer time!
Be sure to manually adjust the time!

Sensor Verification (TAG, GROUP)

When Memosens sensors are calibrated in the lab, it is often useful and sometimes even mandatory that these sensors will be operated again at the same measuring points or at a defined group of measuring points. To ensure this, you can save the respective measuring point (TAG) or group of measuring points (GROUP) in the sensor. TAG and GROUP can be specified by the calibration tool or automatically entered by the transmitter. When connecting an MS sensor to the transmitter, it can be checked if the sensor contains the correct TAG or belongs to the correct GROUP. If not, a message will be generated, Senseface gets "sad", and the display backlighting turns magenta (purple). The "sad" Senseface icon can also be signaled by a 22 mA error current. Sensor verification can be switched on in the Configuration in two steps as TAG and GROUP if required.

When no measuring point or group of measuring points is saved in the sensor, e.g., when using a new sensor, Stratos enters its own TAG and GROUP. When sensor verification is switched off, Stratos always enters its own measuring point and group. A possibly existing TAG/GROUP will be overwritten.

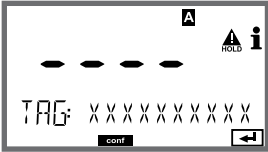
Menu item	Action	Choices
<p>TAG of measuring point</p> 	<p>In the lower display line you can enter a designation for the measuring point (TAG) and for a group of measuring points (GROUP) if applicable. Up to 32 digits are possible. By pressing meas (repeatedly) in the measuring mode you can view the tag number. Select character using ▲ ▼ keys, select next digit using ◀ ▶ keys. Press enter to confirm.</p>	<p>A...Z, 0...9, - + < > ? / @</p> <p>The first 10 characters are seen in the display without scrolling.</p>
<p>GROUP of measuring points</p>	<p>Select number using ▲ ▼ keys, select next digit using ◀ ▶ keys. Confirm by pressing enter</p>	<p>0000 ... 9999 (0000)</p>

Note:

- All calibration procedures must be performed by trained personnel. Incorrectly set parameters may go unnoticed, but change the measuring properties.

Calibration can be performed by:

- determining the cell constant (cell factor for toroidal sensors) with a known calibration solution
- entering the cell constant (cell factor for toroidal sensors)
- sampling (product calibration)
- zero calibration in air or with calibration solution (toroidal sensors)
- temperature probe adjustment

Selecting a Calibration Mode for 2-/4-Electrode Sensors

Calibration adapts the device to the individual sensor characteristics.

Access to calibration can be protected with a passcode (SERVICE menu).

First, you open the calibration menu and select the calibration mode:





CAL_SOL	Calibration with calibration solution
CAL_CELL	Calibration by entry of cell constant
P_CAL	Product calibration (calibration with sampling)
CAL_RTD	Temperature probe adjustment



Selecting a Calibration Mode for Toroidal Sensors

CAL_SOL	Calibration with calibration solution
CAL_CELL	Calibration by input of cell factor
P_CAL	Product calibration (calibration with sampling)
CAL_ZERO	Zero calibration
CAL_RTD	Temperature probe adjustment

134 Calibration with Calibration Solution

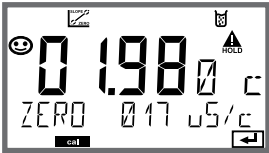
Input of temperature-corrected value of calibration solution with simultaneous display of cell constant (cell factor for toroidal sensors).

Display	Action	Remark
	<p>Select Calibration. Press enter to proceed. Select CAL_SOL calibration method. Press enter to proceed.</p>	
	<p>Ready for calibration. Hourglass blinks.</p>	<p>Display (3 sec) Now the device is in HOLD mode.</p>
	<p>Immerse sensor in cali- bration solution. Enter the temperature-corrected value of the calibration solution using the arrow keys (see table). Press enter to confirm.</p>	<p>Lower line: display of cell constant (cell factor) and temperature</p>
	<p>Contacting conductivity measurement (Cond) The determined cell constant is displayed. The "hourglass" icon is blinking. Proceed by pressing enter</p>	
	<p>Inductive conductivity measurement (CONDI) The determined cell factor and zero point are displayed. The "hourglass" icon is blinking. Proceed by pressing enter</p>	

Display	Action	Remark
 <p>The display shows a large number '1265' followed by 'mS/cm'. Below it, 'MEAS' and 'REPEAT' are visible. There are also 'HOLD' and 'i' icons in the top right corner, and a 'cal' indicator in the bottom left.</p>	<p>Display of selected process variable (here: mS/cm). Now the device is in HOLD mode: Reinstall the sensor and check whether the measurement is OK. MEAS exits calibration, REPEAT permits repetition.</p>	
 <p>The display shows '1265 mS/cm' and 'GOOD BYE' with dashes on either side. A 'MEAS' indicator is in the bottom left, and a 'HOLD' icon is in the top right.</p>	<p>With MEAS selected: Press enter to exit calibration.</p>	<p>Display of conductivity and temperature, Senso-face is active. After end of calibration, the outputs remain in HOLD mode for a short time. After display of GOOD BYE, the device automatically returns to measuring mode.</p>

Please note:



- Be sure to use known calibration solutions and the respective temperature-corrected conductivity values (see “Calibration Solutions” tables).
- Make sure that the temperature does not change during the calibration procedure.





Calibration by sampling – for product calibration, the uncompensated conductivity ($\mu\text{S}/\text{cm}$, mS/cm , S/m) is used.





During product calibration the sensor remains in the process. The measurement process is only interrupted briefly.

Procedure:

- 1) The sample is measured in the lab or directly on the site using a portable meter. To ensure an exact calibration, the sample temperature must correspond to the measured process temperature. During sampling the analyzer saves the currently measured value and then returns to measuring mode. Then, the “calibration” mode indicator blinks.
- 2) In the second step you enter the measured sample value in the device. From the difference between the stored measured value and entered sample value, the device calculates the new cell constant (the new cell factor for toroidal sensors). If the sample is invalid, you can take over the value stored during sampling. In that case, the old calibration values are stored. Afterwards, you can start a new product calibration.

Display	Action	Remark
	Select Calibration. Press enter to proceed. Select P_CAL calibration method. Press enter to proceed.	
	Ready for calibration. Hourglass blinks.	Display (3 sec) Now the device is in HOLD mode.
	Take sample and save value. Press enter to proceed.	Now the sample can be measured in the lab.

Display	Action	Remark
	The device returns to measuring mode.	From the blinking CAL mode indicator, you see that product calibration has not been terminated.
	Product calibration step 2: When the sample value has been determined, open the product calibration once more	Display (3 sec) Now the device is in HOLD mode.
	The stored value is displayed (blinking) and can be overwritten with the lab value. Press enter to proceed.	
	Display of new cell constant / cell factor (based on 25°C). Sensoface is active. To exit calibration: Select MEAS, then enter	To repeat calibration: Select REPEAT, then enter
	End of calibration	After end of calibration, the outputs remain in HOLD mode for a short time.

Display	Action	Remark
	Select Calibration. Press enter to proceed. Select CAL_RTD calibration method. Press enter to proceed.	Wrong settings change the measurement properties!
	Measure the temperature of the process medium using an external thermometer.	Display (3 sec) Now the device is in HOLD mode.
	Enter the measured temperature value. Maximum difference: 10 K. Press enter to proceed.	Display of actual temperature (uncompensated) in the lower display.
	The corrected temperature value is displayed. Sensoface is active. To exit calibration: Select MEAS, then enter To repeat calibration: Select REPEAT, then enter	After end of calibration, the outputs remain in HOLD mode for a short time.
	After calibration is ended, the device will switch to measuring mode.	

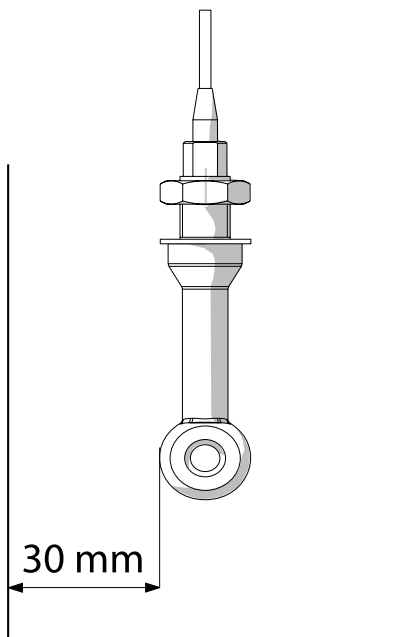





Please note:

When the sensor is installed in a pipe/tank at a distance less than 30 mm from the wall, you should perform the calibration either by means of sampling (product calibration) with the sensor installed or in a suitable calibration beaker with dimensions and material corresponding to the process conditions.

Condi

Calibration by input of cell factor (toroidal sensors)

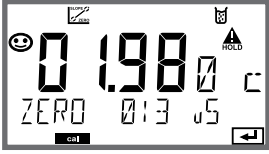



You can directly enter the value for the cell factor of a sensor. The value must be known, eg, determined beforehand in the laboratory. The selected process variable and the temperature are displayed. This method is suitable for all process variables.

Display	Action	Remark
	Select Calibration. Press enter to proceed. Select CAL_CELL calibration method. Press enter to proceed.	
	Ready for calibration. Hourglass blinks.	Display (3 sec) Now the device is in HOLD mode.
	Enter cell factor. Press enter to proceed.	The selected process variable and the temperature are displayed.
	The device shows the calculated cell factor and zero point (at 25 °C). Sensoface is active.	
	Use the arrow keys to select: <ul style="list-style-type: none"> • MEAS (exit) • REPEAT Press enter to proceed.	Exit: HOLD is deactivated after a short time.

Please refer to the Specifications for the nominal cell factor.

When measuring in a restricted space, the individual cell factor must be determined.

Zero calibration in air / with calibration solution (toroidal sensors)

Display	Action	Remark
	<p>Select Calibration. Press enter to proceed. Select CAL_ZERO calibration method. Press enter to proceed.</p>	
	<p>Ready for calibration. Hourglass blinks.</p>	<p>Display (3 sec) Now the device is in HOLD mode.</p>
	<p>Calibration in air Edit digits until the lower display indicates Zero. Calibration in air (AIR-SET) for SE680-M and Memosens sensors: Press enter to start AIR-SET. When zero point and cell factor are displayed, press enter to confirm.</p>	
	<p>The device shows the cell factor (at 25 °C) and the zero point. Sensoface is active.</p>	
	<p>Use the arrow keys to select:</p> <ul style="list-style-type: none"> • MEAS (exit) • REPEAT <p>Press enter to proceed.</p>	<p>Exit: HOLD is deactivated after a short time.</p>

Display

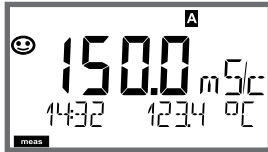

or AM/PM and °F:



Remark

From the configuration or calibration menus, you can switch the device to measuring mode by pressing the **meas** key.

In the measuring mode the upper display line shows the configured process variable (Cond or temperature), the lower display line shows the time and the second configured process variable (Cond or temperature). The [meas] mode indicator lights and the active parameter set (A/B) is indicated. A/B is not displayed with parameter set Fix A.

Note:

- After prolonged power outage (> 5 days), the time display is replaced by dashes and cannot be used for processing. In that case, enter the correct time and the correct date.

By pressing the **meas** key you can step through the following displays. When no key has been pressed for 60 sec, the device returns to the standard display.



- 1) Selecting the parameter set (if set to "manual" in the configuration).
Select the desired parameter set using the ◀ ▶ arrow keys (PARSET A or PARSET B blinks in the lower display line). Press **enter** to confirm.



Further displays (each by pressing **meas**).

- 2) Display of tag number ("TAG")
- 3) Display of time and date
- 4) Display of output currents

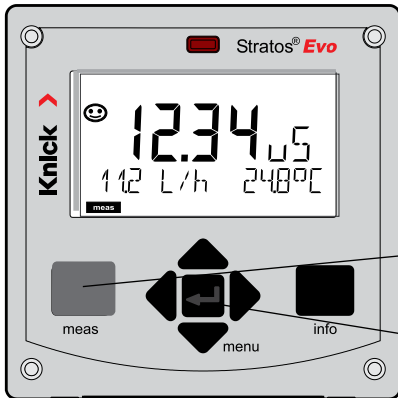

The MAIN DISPLAY is the display which is shown in measuring mode. To call the measuring mode from any other mode, hold the **meas** key depressed for at least 2 sec.

meas key

enter key

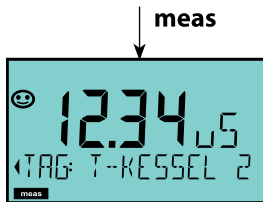

By pressing **meas** briefly you can step through further displays such as tag number (TAG) or flow (L/h).

These displays are turquoise. After 60 sec they switch back to the main display.

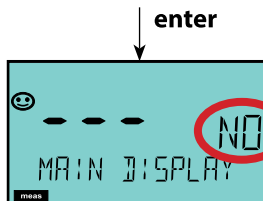
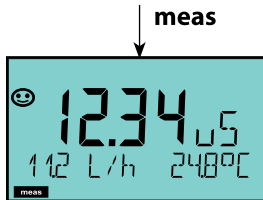

Press **enter** to select a display as MAIN DISPLAY.

The secondary display shows "MAIN DISPLAY – NO".

Use the **UP / DOWN** arrows to select "MAIN DISPLAY – YES"

and confirm by pressing **enter**.

The display color changes to white.

This display is now shown in measuring mode.



The color-coded user interface guarantees increased operating safety. Operating modes are clearly signaled.

The normal measuring mode is white. Information text appears on a green screen and the diagnostic menu appears on turquoise. The orange HOLD mode (e.g., during calibration) is quickly visible as is the magenta screen which indicates asset management messages for predictive diagnostics – such as maintenance request, pre-alarm and sensor wear.

The alarm status has a particularly noticeable red display color and is also signaled by flashing display values. Invalid inputs or false passcodes cause the entire display to blink red so that operating errors are significantly reduced.

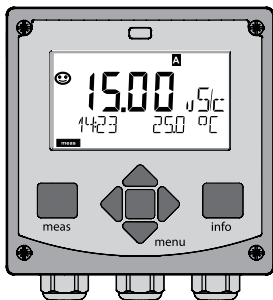

White:
Measuring mode

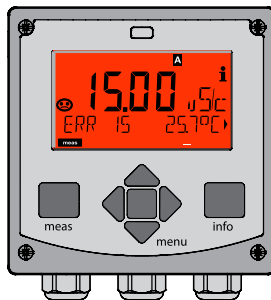

Red blinking:
Alarm, error

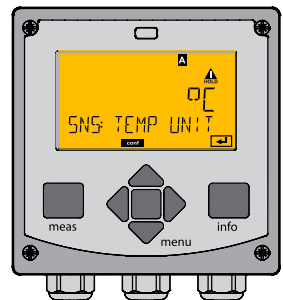

Orange:
HOLD mode

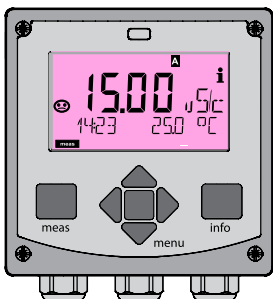

Magenta:
Maintenance request

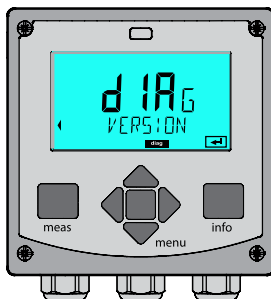

Turquoise:
Diagnostics

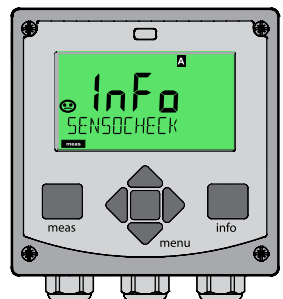

Green:
Info texts

Display**Remark****With activated controller**

you can also step through the following displays by pressing the **meas** key. When no key has been pressed for 60 sec, the device returns to the standard display.



Upper display: Controller output Y

The controller output can be modified using ▲ ▼ .

This allows control systems to be tested and, above all, started smoothly.

Lower display: Setpoint

Depending on configuration setting:
conductivity or temperature.

In the Diagnostics mode you can access the following menus without interrupting the measurement:

- CALDATA Viewing the calibration data
- SENSOR Viewing the sensor data
- SELFTEST Starting a device self-test
- LOGBOOK Viewing the logbook entries
- MONITOR Displaying currently measured values,
Remaining capacity of the ion exchanger
- VERSION Displaying device type, software version, serial number

Access to diagnostics can be protected with a passcode (SERVICE menu).

Note:

HOLD is not active during Diagnostics mode!

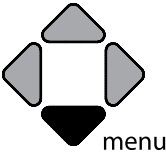
Action	Key	Remark
Activate diagnostics		Press menu key to call the selection menu. (Display color changes to turquoise.) Select DIAG using ◀ ▶ keys, confirm by pressing enter
Select diagnostics option		Use ◀ ▶ keys to select from: CALDATA SENSOR SELFTEST LOGBOOK MONITOR VERSION See next pages for further proceeding.
Exit	meas	Exit by pressing meas .

Display**Menu item****Display of calibration data**

Select CALDATA using ◀ ▶, confirm by pressing **enter**. Use the ◀ ▶ keys to select the desired parameter from the bottom line of the display:

The selected parameter is shown in the upper display line.

Press **meas** to return to measurement.

Display

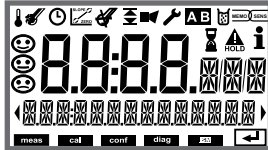

Menu item

Device self-test

(To abort, you can press **meas**.)

- 1) **Display test:** Display of all segments with changing background colors (white/green/red). Proceed by pressing **enter**
- 2) **RAM test:** Hourglass blinks, then display of --PASS-- or --FAIL-- Proceed by pressing **enter**
- 3) **EEPROM test:** Hourglass blinks, then display of --PASS-- or --FAIL-- Proceed by pressing **enter**
- 4) **FLASH test:** Hourglass blinks, then display of --PASS-- or --FAIL-- Proceed by pressing **enter**
- 5) **Module test:** Hourglass blinks, then display of --PASS-- or --FAIL-- Return to measuring mode by pressing **enter** or **meas**

Display



Menu item

Displaying the logbook entries

Select LOGBOOK using ◀ ▶, press **enter** to confirm.

With the ▲ ▼ keys, you can scroll backwards and forwards through the logbook (entries -00-...-99-), -00- being the last entry.

If the display is set to date/time, you can search for a particular date using the ▲ ▼ keys.

Press ◀ ▶ to view the corresponding message text.

If the display is set to the message text, you can search for a particular message using the ▲ ▼ keys.

Press ◀ ▶ to display the date and time.

Press **meas** to return to measurement.

Extended logbook / Audit Trail (via TAN)

With the ▲ ▼ keys, you can scroll backwards and forwards through the extended logbook (entries -000-...-99-), -000- being the last entry.

Display: CFR

Audit Trail also records function activations (CAL CONFIG SERVICE), some Sensoface messages (cal timer, wear), and opening of the enclosure.

Display



Display example:



Remaining capacity
of the ion exchanger

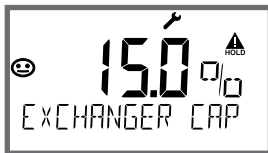

Menu item

Displaying the currently measured values (sensor monitor)

Select MONITOR using ◀ ▶, press **enter** to confirm. Use the ◀ ▶ keys to select the desired parameter from the bottom line of the display (R_COND G_COND RTD TEMP I-INPUT (Option)).

The selected parameter is shown in the upper display line.

When calculating the consumption of the ion exchanger has been activated in the configuration, the sensor monitor shows the remaining capacity of the ion exchanger.

Press **meas** to return to measurement.

Version

Display of **device type, software/hardware/boot-loader version** and **serial number** for all device components.



Use the ▲ ▼ keys to switch between software and hardware version. Press **enter** to proceed to next device component.



In the Service mode you can access the following menus:

MONITOR	Displaying currently measured values
NEW EXCHANGER	Resetting the consumption calculation after replacement of ion exchanger
POWER OUT	Power output (adjustable: 3.1/12/15/24 V)
OUT1	Testing current output 1
OUT2	Testing current output 2
RELAIS	Testing the function of the 4 relays
CONTROL	Testing the controller function
CODES	Assigning and editing passcodes
DEVICE TYPE	Selecting the measuring function
DEFAULT	Resetting the device to factory settings
OPTION	Enabling options via TAN

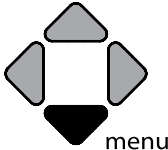
Note:

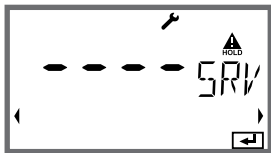
HOLD is active during Service mode!

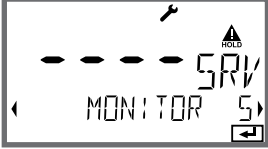
Action	Key/Display	Remark
Activate Service		Press menu key to call the selection menu. Select SERVICE using ◀ ▶ keys, press enter to confirm.
Passcode		Enter passcode "5555" for service mode using the ▲ ▼ ◀ ▶ keys. Press enter to confirm.
Display		In service mode the following icons are displayed: <ul style="list-style-type: none"> • HOLD triangle • Service (wrench)
Exit	meas	Exit by pressing meas .

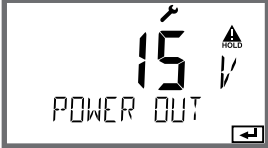
Menu item	Remark
 <p>The LCD display shows a top status bar with a wrench icon, a 'HOLD' indicator, and a lightning bolt icon. Below this, the word 'MONITOR' is displayed in the center. To the right of 'MONITOR', the value '5.0V' is shown in a larger font, and below it, the number '5' is displayed. Navigation arrows are visible on the left and right sides of the screen.</p>	<p>Displaying currently measured values (sensor monitor) with HOLD mode activated:</p> <p>Select MONITOR using ◀ ▶, press enter to confirm.</p> <p>Select variable in the bottom text line using ◀ ▶.</p> <p>The selected parameter is shown in the upper display line.</p> <p>As the device is in HOLD mode, you can perform validations using simulators without influencing the signal outputs.</p> <p>Hold meas depressed for longer than 2 sec to return to Service menu.</p> <p>Press meas once more to return to measurement.</p>
<p>NEW EXCHANGER</p>  <p>The LCD display shows a top status bar with a wrench icon, a 'HOLD' indicator, and a lightning bolt icon. Below this, the text 'NEW EXCHANGER' is displayed in the center. To the right, the word 'YES' is shown in a larger font. Navigation arrows are visible on the left and right sides of the screen.</p>	<p>When you have replaced the ion exchanger, select "YES" to reset the consumption calculation.</p>
<p>POWER OUT</p>  <p>The LCD display shows a top status bar with a wrench icon, a 'HOLD' indicator, and a lightning bolt icon. Below this, the text 'POWER OUT' is displayed in the center. To the right, the number '15' is shown in a large font. Navigation arrows are visible on the left and right sides of the screen.</p>	<p>POWER OUT, adjusting the output voltage</p> <p>Here, you can select an output voltage of 3.1/12/15/24 V.</p>

Menu item



Remark

Specifying the current for outputs 1 and 2:

Select OUT1 or OUT2 using the ◀ ▶ keys, press **enter** to confirm.

Enter a valid current value for the respective output using ▲ ▼ ◀ ▶ keys.

Confirm by pressing **enter**.

For checking purposes, the actual output current is shown in the bottom right corner of the display.

Exit by pressing **enter** or **meas**.

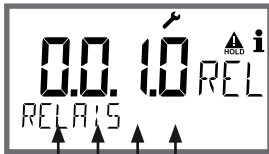

REL1
REL2
ALARM
WASH

Relay test (manual test of contacts):

Select RELAIS using ◀ ▶, press **enter** to confirm.

Now the status of the 4 relays is "frozen". The 4 digits of the main display represent the respective states (from left to right: REL1, REL2, ALARM, WASH).





The digit for the selected relay blinks.

Select one of the 4 relays using the ◀ ▶ keys, close (1) or open (0) using the ▲ ▼ keys.

Exit by pressing **enter**.

The relays will be re-set corresponding to the measured value.

Press **meas** to return to measurement.

Menu item	Remark
	<p>Assigning passcodes: In the "SERVICE - CODES" menu you can assign passcodes to DIAG, HOLD, CAL, CONF and SERVICE modes (Service preset to 5555).</p> <p>When you have lost the Service passcode, you have to request an "Ambulance TAN" from the manufacturer specifying the serial number and hardware version of your device. To enter the "Ambulance TAN", call the Service function and enter passcode 7321. After correct input of the ambulance TAN the device signals "PASS" for 4 sec and resets the Service passcode to 5555.</p>
	<p>Reset to factory settings: In the "SERVICE - DEFAULT" menu you can reset the device to factory settings.</p> <p>NOTICE! After a reset to factory setting the device must be reconfigured completely, including the sensor parameters!</p>
	<p>Option request: Communicate the serial number and hardware/software version of your device to the manufacturer. These data can be viewed in the Diagnostics/Version menu. The "transaction number" (TAN) you will then receive is only valid for the device with the corresponding serial number.</p> <p>Releasing an option: Options come with a "transaction number" (TAN). To release the option, enter this TAN and confirm by pressing enter.</p>
	<p>Device type: Changing the measuring function, e.g., after having replaced a Memosens sensor. Not possible with a measuring module installed.</p>

Power Disruption while Loading the Process Variable





In very rare cases it seems that the analyzer cannot be operated because it remains in "Firmware Update" mode – indicated by the --FIRMW UPDATE-- message.



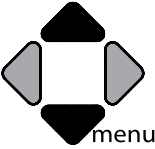

This occurs when the power is disrupted while the process variable is loaded.

Follow the instructions below to fix the error.



--FIRMW UPDATE--

Action	Key/Display	Remark
Device start		If the power supply is disrupted while the process variable is loaded (e.g., during initial start-up or when changing the process variable), the following can occur:
Reconnecting the power supply		After the power supply has been reconnected, the analyzer starts and then remains in --FIRMW UPDATE-- mode. If this occurs, disconnect the power supply.
Restoring the factory settings		Press the ▲ ▼ keys simultaneously and hold them depressed while the analyzer is reconnected to the power supply.
Device start		Release the keys when the display shows LOADING BASE. The analyzer will restart with the BASE software when 100 % is reached.

Action	Key/Display	Remark
Searching for the process variable		Then the analyzer searches for a measuring module or Memosens sensor.
Loading the process variable, automatic		When a module or a sensor has been found, the loading progress is shown in percentages.
Loading the process variable, manual		If neither module nor sensor are found, the display shows DEVICE TYPE. The selected process variable blinks. You can modify it using the ▲ ▼ keys. Press enter to load the process variable displayed.
Loading ...		Make sure that the power supply is not interrupted before the process variable is fully loaded (100%) .

Error	Info text (is displayed in case of fault when the Info key is pressed)	Problem Possible causes
ERR 01	NO SENSOR	Sensor error Device type not assigned Defective sensor Sensor not connected Break in sensor cable
ERR 02	WRONG SENSOR	Wrong sensor
ERR 04	SENSOR FAILURE	Failure in sensor
ERR 05	CAL DATA	Error in cal data
ERR 10	CONDUCTANCE TOO HIGH Device type Cond-Cond: Channel A	Measuring range of conductance exceeded
ERR 11	RANGE CONDUCTIVITY Device type Cond-Cond: Channel A	Display range violation
ERR 13	TEMPERATURE RANGE Device type Cond-Cond: Channel A	Temperature range violation
ERR 15	SENSOCHECK Device type Cond-Cond: Channel A	Sensor or line error
ERR 40	CONDUCTANCE TOO HIGH Device type Cond-Cond: Channel B	Measuring range of conductance exceeded
ERR 41	RANGE CONDUCTIVITY Device type Cond-Cond: Channel B	Display range violation
ERR 43	TEMPERATURE RANGE Device type Cond-Cond: Channel B	Temperature range violation
ERR 45	SENSOCHECK Device type Cond-Cond: Channel B	Sensor or line error

Error	Info text (is displayed in case of fault when the Info key is pressed)	Problem Possible causes
ERR 59	INVALID CALCULATION	Invalid calculations
ERR 60	OUTPUT LOAD	Load error
ERR 61	OUTPUT 1 TOO LOW	Output current 1 < 0 (3.8) mA
ERR 62	OUTPUT 1 TOO HIGH	Output current 1 > 20.5 mA
ERR 63	OUTPUT 2 TOO LOW	Output current 2 < 0 (3.8) mA
ERR 64	OUTPUT 2 TOO HIGH	Output current 2 > 20.5 mA
ERR 72	FLOW TOO LOW	Flow too low
ERR 73	FLOW TOO HIGH	Flow too high
ERR 74	CATION EXCHANGER INVALID CALCULATION	Flow too low or no flow: Flow \leq 4.00 l/h; calculated pH value: < 7.5 or > 10.5; conductivity values: $B \geq 3 \times A$

Error	Info text (is displayed in case of fault when the Info key is pressed)	Problem Possible causes
ERR 95	SYSTEM ERROR	System error Restart required. If error still persists, send in the device for repair.
ERR 96	WRONG MODULE	Module does not correspond to measuring function Correct the setting in the SERVICE / DEVICE TYPE menu. Afterwards, configure and calibrate the device.
ERR 97	NO MODULE INSTALLED	No module installed
ERR 98	CONFIGURATION ERROR	Error in configuration or calibration data Configuration or calibration data defective; completely reconfigure and recalibrate the device.
ERR 99	DEVICE FAILURE	Error in factory settings EEPROM or RAM defective This error message only occurs in the case of a total defect. The device must be repaired and recalibrated at the factory.

Error	Info text (is displayed in case of fault when the Info key is pressed)	Problem Possible causes
ERR 104	INVALID PARAMETER CONTROLLER	Configuration error Controller
ERR 105	INVALID SPAN I-INPUT	Configuration error Current input
ERR 106	INVALID CHANNEL SELECTION OUT1/2	Cond-Cond: Out1/Out2 channel not assigned (disabled)
ERR 107	INVALID CHANNEL SELECTION RELAYS	Cond-Cond: Relay channel not assigned (disabled)
ERR 108	Cond, Condi, Cond-Cond: OUT1 INVALID CORNER X/Y	Bilinear curve: Invalid vertex point
ERR 109	Cond, Condi, Cond-Cond: OUT2 INVALID CORNER X/Y	Bilinear curve: Invalid vertex point
ERR 110	CATION EXCHANGER CAPACITY	Capacity of ion exchanger used up – replace

Sensoface messages:

Cell factor monitoring	SENSOR CELL FACTOR CALIBRATE OR CHANGE SENSOR
Table monitoring (TC/Conc/Sal/USP)	OUT OF INTERNAL TABLE
Zero point monitoring	SENSOR ZERO CALIBRATE OR CHANGE SENSOR
Cell factor / zero point monitoring	SENSOR ZERO/CELL FACTOR CALIBRATE OR CHANGE SENSOR
Sensor TAG does not correspond to device entry.	WRONG SENSOR TAG
Sensor GROUP does not correspond to device entry.	WRONG SENSOR GROUP xxxx

Sensocheck, Sensoface Sensor Monitoring



Sensocheck continuously monitors the sensor and its wiring. The three Sensoface indicators provide information on required maintenance of the sensor. Additional icons refer to the error cause. Pressing the **info** key shows an information text.

Note:

The worsening of a Sensoface criterion leads to the devaluation of the Sensoface indicator (Smiley gets “sad”). An improvement of the Sensoface indicator can only take place after calibration or removal of the sensor defect.

Sensoface message

The Sensocheck message is also output as error message Err 15.

The alarm contact is active, the display backlighting turns red (when configured correspondingly).

Sensoface can be output as a 22-mA signal via the current outputs.

Disabling Sensocheck and Sensoface

Sensocheck can be switched off in the configuration menu (then Sensoface is also disabled).

Exception:

After a calibration, a smiley is always displayed for confirmation.





























Monitoring function for device type Cond-Cond

When the remaining capacity of the ion exchanger is at 20 %, the wrench icon is displayed to indicate a maintenance request together with the “CATION EXCHANGER CAPACITY” info message.

When capacity is depleted (0%),

the **ERR 110** error message is displayed in addition.

Without Sensoface!

Operating status	OUT 1	OUT 2	REL1/2	Alarm	Time out
Measure					-
DIAG					60 s
HOLD					No
CAL					No
CONF					20 min
SERVICE					20 min
SERVICE OUT 1					20 min
SERVICE OUT 2					20 min
SERVICE RELAIS					20 min
SERVICE (CODES, DEVICE TYPE; OPTION)					20 min
Cleaning function					No

Explanation:



as configured (Last/Fix or Last/Off)



active



manual

Devices (basic digital devices)

Stratos Evo A402N

Stratos Evo A402B (operation in hazardous locations, Zone 2)

Order No.

A402N

A402B

**Interchangeable modules for measurement with analog sensors
or 2nd Memosens channel**

pH	MK-PH015N
Oxy	MK-OXY045N
Cond	MK-COND025N
Condl	MK-CONDI035N
Cond-Cond	MK-CC065N
2nd Memosens channel	MK-MS095N

**Interchangeable modules for measurement with analog sensors,
hazardous area Zone 2**

pH, hazardous area Zone 2	MK-PH015X
Oxy, hazardous area Zone 2	MK-OXY045X
Cond, hazardous area Zone 2	MK-COND025X
Condl, hazardous area Zone 2	MK-CONDI035X

TAN options

HART	SW-A001
Logbook	SW-A002
Extended logbook (AuditTrail)	SW-A003
Oxygen trace measurement	SW-A004
Current input	SW-A005
ISM digital	SW-A006
Pfautler	SW-A007

Mounting accessories

Pipe-mount kit

ZU 0274

Panel-mount kit

ZU 0738

Protective hood

ZU 0737

M12 socket for sensor connection
with Memosens cable / M12 connector

ZU 0860

Up-to-date information:

www.knick.de

Phone: +49 30 80191-0

Fax: +49 30 80191-200

Email: info@knick.de

Cond

"Device Type" Cond

Sensor input, digital	Memosens conductivity sensors	
Display ranges	Conductivity	0.000 ... 9.999 $\mu\text{S}/\text{cm}$ 00.00 ... 99.99 $\mu\text{S}/\text{cm}$ 000.0 ... 999.9 $\mu\text{S}/\text{cm}$ 0000 ... 9999 $\mu\text{S}/\text{cm}$ 0.000 ... 9.999 mS/cm 00.00 ... 99.99 mS/cm 000.0 ... 999.9 mS/cm 0.000 ... 9.999 S/cm 00.00 ... 99.99 S/cm
	Resistivity	00.00 ... 99.99 $\text{M}\Omega \cdot \text{cm}$
	Concentration	0.00 ... 100 %
	Salinity	0.0 ... 45.0 ‰
	Measurement error	See sensor specifications
Measuring range	See Memosens sensor	
Temperature compensation*	(OFF)	Without
	(LIN) Reference temp specifiable	Linear characteristic 00.00 ... 19.99 %/K
	(NLF) Ref. temp 25 °C/77 °F	Natural waters acc. to EN 27888
	(NaCl) Ref. temp 25 °C/77 °F	NaCl from 0 (ultrapure water) to 26% by wt
	(HCl) Ref. temp 25 °C/77 °F	Ultrapure water with HCl traces (0 ... +120 °C / +32 ... +248 °F)
	(NH ₃) Ref. temp 25 °C/77 °F	Ultrapure water with NH ₃ traces (0 ... +120 °C / +32 ... +248 °F)
	(NaOH) Ref. temp 25 °C/77 °F	Ultrapure water with NaOH traces (0 ... +120 °C / +32 ... +248 °F)
Concentration determination*	-01- NaCl	0 – 26 wt% (0 °C / 32 °F) ... 0 – 28 wt% (100 °C/212 °F)
	-02- HCl	0 – 18 wt% (-20 °C / -4 °F) ... 0 – 18 wt% (50 °C/122 °F)
	-03- NaOH	0 – 13 wt% (0 °C / 32 °F) ... 0 – 24 wt% (100 °C/212 °F)
	-04- H ₂ SO ₄	0 – 26 wt% (-17 °C/1.4 °F)...0 – 37 wt% (110 °C/230 °F)
	-05- HNO ₃	0 – 30 wt% (-20 °C / -4 °F) ... 0 – 30 wt% (50 °C/122 °F)
	-06- H ₂ SO ₄	94 – 99 wt% (17 °C/1.4 °F)...89 – 99 wt% (115 °C/239 °F)
	-07- HCl	22 – 39 wt% (-20 °C / -4 °F)...22 – 39 wt% (50 °C/122 °F)
	-08- HNO ₃	35 – 96 wt% (-20 °C / -4 °F)...35 – 96 wt% (50 °C/122 °F)
	-09- H ₂ SO ₄	28 – 88 wt% (17 °C/1.4 °F)...39 – 88 wt% (115 °C/239 °F)
	-10- NaOH	15 – 50 wt% (0 °C/32 °F)...35 – 50 wt% (100 °C/212 °F)
	-11- H ₂ SO ₄ ·SO ₃ (oleum)	13 – 45 wt% (0 °C / 32 °F) ... 13 – 45 wt% (120 °C/248 °F)

Sensocheck	Polarization detection
	Delay Approx. 30 s
Sensoface	Provides information on the sensor condition
Sensor monitor	Direct display of measured values from sensor for validation (resistance/temperature)

* User-defined

Condl

"Device Type" Condl

Sensor input, digital	Digital toroidal conductivity sensors (SE 670 / SE680-K/SE680-M/Memosens)	
Measuring range	Conductivity	0.000 ... 1999 mS/cm
	Concentration	0.00 ... 100.0 wt%
	Salinity	0.0 ... 45.0 ‰ (0 ... 35 °C / +32 ... +86 °F)
Measuring ranges	Conductivity	000.0 ... 999.9 µS/cm 0.000 ... 9.999 mS/cm 00.00 ... 99.99 mS/cm 000.0 ... 999.9 mS/cm 0000 ... 1999 mS/cm 0.000 ... 9.999 S/m 00.00 ... 99.99 S/m
	Concentration	0.00 ... 9.99 % / 10.0 ... 100.0 %
	Salinity	0.0 ... 45.0 ‰ (0 ... 35 °C / +32 ... +86 °F)
	Response time (T90)	Approx. 1 s
	Temperature	-20 ... +150 °C / -4 ... +302 °F
	Temperature extrapolation	Quick extrapolation of the temperature in the case of a significant change (SE 670 / SE 680)
	Measurement error	See sensor specifications
Temperature compensation*	(OFF)	Without
	(Lin)	Linear characteristic 00.00 to 19.99 %/K
	(NLF)	Natural waters acc. to EN 27888
	(NaCl)	NaCl from 0 to 26 wt% (0 ... 120 °C / -4 ... +248 °F)
	Ultrapure water	NaCl, HCl, NH ₃ , NaOH
Concentration determination*	-01- NaCl	0 - 26 wt% (0 °C / 32 °F) ... 0 - 28 wt% (100 °C / 212 °F)
	-02- HCl	0 - 18 wt% (-20 °C / -4 °F) ... 0 - 18 wt% (50 °C / 122 °F)
	-03- NaOH	0 - 13 wt% (0 °C / 32 °F) ... 0 - 24 wt% (100 °C / 212 °F)
	-04- H ₂ SO ₄	0 - 26 wt% (-17 °C / 1.4 °F) ... 0 - 37 wt% (110 °C / 230 °F)
	-05- HNO ₃	0 - 30 wt% (-20 °C / -4 °F) ... 0 - 30 wt% (50 °C / 122 °F)
	-06- H ₂ SO ₄	94 - 99 wt% (17 °C / 1.4 °F) ... 89 - 99 wt% (115 °C / 239 °F)
	-07- HCl	22 - 39 wt% (-20 °C / -4 °F) ... 22 - 39 wt% (50 °C / 122 °F)
	-08- HNO ₃	35 - 96 wt% (-20 °C / -4 °F) ... 35 - 96 wt% (50 °C / 122 °F)
	-09- H ₂ SO ₄	28 - 88 wt% (17 °C / 1.4 °F) ... 39 - 88 wt% (115 °C / 239 °F)
	-10- NaOH	15 - 50 wt% (0 °C / 32 °F) ... 35 - 50 wt% (100 °C / 212 °F)
	-11- H ₂ SO ₄ ·SO ₃ (oleum)	13 - 45 wt% (0 °C / 32 °F) ... 13 - 45 wt% (120 °C / 248 °F)

Sensor standardization	<ul style="list-style-type: none"> – Input of cell factor with simultaneous display of conductivity/temperature – Input of conductivity of calibration solution with simultaneous display of cell factor and temperature – Product calibration – Zero adjustment – Installation factor – Temp probe adjustment (10 K)
	<p>Permissible cell factor 00.100 ... 19.999/cm</p> <p>Permissible transfer ratio 010.0 ... 199.9</p> <p>Permissible zero offset ±0.5 mS/cm</p> <p>Permissible installation factor 0.100 ... 5.000</p>
Sensocheck	<p>Monitoring of primary and secondary coils and lines for open circuit and of primary coil and lines for short circuit</p> <p>Delay Approx. 30 s</p>
Sensoface	<p>Provides information on the sensor condition (zero point, cell factor, installation factor, Sensocheck, TAG/GROUP sensor verification)</p>
Sensor monitor	<p>Direct display of measured values from sensor for validation (resistance/temperature)</p>

* User-defined

Cond

Cond

COND inputs A/B	Two inputs for two 2-electrode sensors		
Measuring range	0 ... 30,000 $\mu\text{S} \cdot \text{cm}$		
Display ranges	Conductivity	0.000 ... 9.999 mS/cm 00.00 ... 99.99 mS/cm 000.0 ... 999.9 mS/cm 0000 ... 9999 $\mu\text{S}/\text{cm}$ 00.00 ... 99.99 M Ω cm	
Measurement error ¹⁾	Response time (T90)	Approx. 1 s	
Temperature compensation*	< 1 % meas. val. + 0.4 $\mu\text{S} \cdot \text{cm}$		
	(OFF)	Without	
	(Lin)	Linear characteristic 00.00 to 19.99 %/K	
	(NLF)	Natural waters acc. to EN 27888	
	(NaCl)	Ultrapure water with NaCl traces (0 ... 120 °C)	
	(HCL)	Ultrapure water with HCl traces (0 ... 120 °C)	
	(NH3)	Ultrapure water with NH3 traces (0 ... 120 °C)	
	(NaOH)	Ultrapure water with NaOH traces (0 ... 120 °C)	
Sensor standardization Channel A/B	Input of cell factor with simultaneous display of conductivity and temperature		
Permissible cell factor	0.0050 ... 1.9999 cm^{-1}		
Calculations (CALC)	-C1-	Difference	A - B [$\mu\text{S}/\text{cm}$]
	-C2-	Ratio	A / B [00.00 ... 19.99]
	-C3-	Passage	B / A • 100 000.0 ... 199.9 %
	-C4-	Rejection	(A-B)/A • 100 -199.9 ... 199.9 %
	-C5-	Deviation	(B - A) / A • 100 -199.9 ... 199.9 %
	-C6-	pH value	Acc. to directive VGB S-006 [pH]
	-C7-	pH value	variable, specifiable factors [pH]
	-C8-	User spec (DAC Degassed Acid Conductivity) [$\mu\text{S}/\text{cm}$]	
	-C9-	Concentration of the alkalinizing agent (VGB S-006)	
Sensocheck	Polarization detection and monitoring of cable capacitance Delay approx. 30 s		
Sensoface	Provides information on the sensor condition, Sensocheck, flow monitoring, ion exchanger monitoring		
Sensor monitor	Direct display of measured values from sensor for validation (resistance/temperature)		
Temperature input A/B	Pt1000, 2-wire connection		
Measuring range	-50 ... +200 °C / -58 ... +392 °F		
Resolution	0.1 °C / 0.1 °F		
Measurement error ¹⁾	0.5 K (1 K > 100 °C)		

* User-defined

I input (SW-A005)	4 ... 20 mA / 50 Ω		
	Function	Input of pressure or temperature values from external sensors	
	Resolution	Approx. 0.05 mA	
	Characteristic	Linear, bilinear, logarithmic	
	Measurement error ¹⁾	< 1% current value + 0.1 mA	
Door contact	outputs a signal when the door is open Entry to extended logbook (FDA)		
HOLD input (SW-A005)	Galvanically separated (optocoupler)		
	Function	Switches device to HOLD mode	
	Switching voltage	0 ... 2 V AC/DC	HOLD inactive
		10 ... 30 V AC/DC	HOLD active
CONTROL input* (SW-A005)	Galvanically separated (optocoupler)		
	Function	Selecting parameter set A/B or flow measurement (FLOW)	
	Switching voltage	0 ... 2 V AC/DC	Parameter set A
		10 ... 30 V AC/DC	Parameter set B
	FLOW	Pulse input for flow measurement	
		0 ... 100 pulses/sec	
	Display	00.0 ... 99.9 l/h	
Output 1	0/4 ... 20 mA, max. 10 V, floating (galvanically connected to output 2), HART communication		
	Overrange*	22 mA in the case of error messages	
	Characteristic	Linear, bilinear, logarithmic	
	Output filter*	PT ₁ filter, time constant 0 ... 120 s	
	Measurement error ¹⁾	< 0.25% current value + 0.025 mA	
	Start/end of scale*	Configurable within the measuring range of the selected process variable	
	Output 2	0/4 ... 20 mA, max. 10 V, floating (galvanically connected to output 1)	
Overrange*		22 mA in the case of error messages	
Characteristic		Linear, bilinear, logarithmic	
Output filter*		PT ₁ filter, time constant 0 ... 120 s	
Measurement error ¹⁾		< 0.25% current value + 0.025 mA	
Start/end of scale*		Configurable within the measuring range of the selected process variable	

Power Out	Power output, e.g., for supplying additional transmitters or relay contacts (signal evaluation via I input) Power supply	Selectable between 3.1 V / 12 V / 15 V / 24 V, short-circuit-proof Power max. 1 W
Alarm contact	Relay contact, floating Contact ratings Contact response Response delay*	AC < 250 V / < 3 A / < 750 VA DC < 30 V / < 3 A / < 90 W N/C (fail-safe type) 0 ... 600 s
Wash contact or parameter set A/B	Relay contact, floating Contact ratings Contact response* Wash contact* ¹⁾ Cleaning Parameter set A/B Contact response	AC < 250 V / < 3 A / < 750 VA DC < 30 V / < 3 A / < 90 W N/C or N/O Interval 0.0 ... 999.9 h (0.0 h = cleaning function switched off) 0 ... 1999 s Signaling parameter set A/B Contact open: Parameter set A active Contact closed: Parameter set B active
Min/max limits	Min/max contacts, floating, but inter-connected Contact ratings Contact response* Response delay* Setpoints* Hysteresis*	AC < 250 V / < 3 A / < 750 VA DC < 30 V / < 3 A / < 90 W N/C or N/O 0 ... 9999 s As desired within range User-defined
PID process controller	Output via limit contacts Setpoint specification* Neutral zone Cond / Condl* Proportional action* Integral action* Derivative action* Controller type* Pulse period* Max. pulse frequency*	Within selected range Max. 50 % of selected range / 0 ... 50 K Controller gain Kp: 10 ... 9999 % Reset time Tr: 0 ... 9999 s (0 s = no integral action) Rate time Td: 0 ... 9999 s (0 s = no derivative action) Pulse length controller or pulse frequency controller 1 ... 600 s, min. turn-on time 0.5 s (pulse length controller) 1 ... 180/min (pulse frequency controller)

Real-time clock	Different time and date formats selectable
	Power reserve > 5 days
Display	LC display, 7-segment with icons, colored backlighting
	Primary display Character height approx. 22 mm Unit symbols approx. 14 mm
	Secondary display Character height approx. 10 mm
	Text line 14 characters, 14 segments
	Sensoface 3 status indicators (friendly, neutral, sad smiley).
	Mode Indicators meas, cal, conf, diag Further icons for configuration and messages
	Alarm indication Display blinks, red backlighting
Keypad	Keys meas, info, 4 cursor keys, enter
2 parameter sets	Parameter set A and B (not with MK-CC 065 module) switchover via CONTROL input or manual
Diagnostics functions	Calibration data Depending on the selected process variable
	Device self-test Automatic memory test (RAM, FLASH, EEPROM)
	Display test Display of all segments
	Logbook (SW-A002) Recording of events, 100 entries
	Extended logbook (SW-A003) Audit trail recording according to 21 CFR Part 11 200 entries
HART communication (SW-A001)	Digital communication via FSK modulation of output current 1, HART version 6
	Device identification, measured values, status and messages, parameter setting, calibration, records
	Conditions Output current ≥ 3.8 mA Load resistance $\geq 250 \Omega$
FDA 21 CFR Part 11	Access control by editable passcodes
	Logbook entry and flag via HART in the case of configuration changes
	Message and logbook entry when enclosure is opened
Service functions	Current source Current specifiable for output 1 / 2 (00.00 ... 22.00 mA)
	Manual controller Controller output entered directly (start of control process)
	Sensor monitor Display of direct sensor signals
	Relay test Manual control of relay contacts

Data retention	Parameters, calibration data, logbook > 10 years (EEPROM)
Electrical safety	Protection against electric shock by protective separation of all extra-low-voltage circuits against mains according to EN 61010-1
Explosion protection A402B	See Control Drawing or www.knick.de
EMC	EN 61326 Emitted interference Class B (residential environment) Immunity to interference Industry
RoHS conformity	according to EC directive 2002/95/EC
Power supply	80 V (-15%) ... 230 (+10%) V AC ; ≤ 10 W ; 45 ... 65 Hz 24 V (-15%) ... 60 (+10%) V DC ; 10 W Overvoltage category II, protection class II
Nominal operating conditions	Ambient temperature -20 ... +55 °C Transport/Storage temperature -30 ... +70 °C Relative humidity 10 ... 95 % not condensing
Housing	Molded enclosure made of PBT/PC, glass-reinforced Mounting Wall, pipe/post or panel mounting Color Gray, RAL 7001 Ingress protection IP 67 / NEMA 4X outdoor (with pressure compensation) Flammability UL 94 V-0 Dimensions H 148 mm, W 148 mm, D 117 mm Control panel cutout 138 mm x 138 mm to DIN 43 700 Weight 1.2 kg Cable glands 3 knockouts for M20 x 1.5 cable glands 2 knockouts for NPT ½" or rigid metallic conduit Connections Terminals, conductor cross section max. 2.5 mm ²

* User-defined

1) Acc. to EN 60746-1, at nominal operating conditions

Potassium Chloride Solutions

(Conductivity in mS/cm)

Temperature [°C]	Concentration ¹		
	0.01 mol/l	0.1 mol/l	1 mol/l
0	0.776	7.15	65.41
5	0.896	8.22	74.14
10	1.020	9.33	83.19
15	1.147	10.48	92.52
16	1.173	10.72	94.41
17	1.199	10.95	96.31
18	1.225	11.19	98.22
19	1.251	11.43	100.14
20	1.278	11.67	102.07
21	1.305	11.91	104.00
22	1.332	12.15	105.94
23	1.359	12.39	107.89
24	1.386	12.64	109.84
25	1.413	12.88	111.80
26	1.441	13.13	113.77
27	1.468	13.37	115.74
28	1.496	13.62	
29	1.524	13.87	
30	1.552	14.12	
31	1.581	14.37	
32	1.609	14.62	
33	1.638	14.88	
34	1.667	15.13	
35	1.696	15.39	
36		15.64	

¹ Data source: K. H. Hellwege (Editor), H. Landolt, R. Börnstein: Zahlenwerte und Funktionen ..., volume 2, part. volume 6

Sodium Chloride Solutions

(Conductivity in mS/cm)

Temperature [°C]	Concentration		
	0.01 mol/l ¹⁾	0.1 mol/l ¹⁾	Saturated ²⁾
0	0.631	5.786	134.5
1	0.651	5.965	138.6
2	0.671	6.145	142.7
3	0.692	6.327	146.9
4	0.712	6.510	151.2
5	0.733	6.695	155.5
6	0.754	6.881	159.9
7	0.775	7.068	164.3
8	0.796	7.257	168.8
9	0.818	7.447	173.4
10	0.839	7.638	177.9
11	0.861	7.831	182.6
12	0.883	8.025	187.2
13	0.905	8.221	191.9
14	0.927	8.418	196.7
15	0.950	8.617	201.5
16	0.972	8.816	206.3
17	0.995	9.018	211.2
18	1.018	9.221	216.1
19	1.041	9.425	221.0
20	1.064	9.631	226.0
21	1.087	9.838	231.0
22	1.111	10.047	236.1
23	1.135	10.258	241.1
24	1.159	10.469	246.2
25	1.183	10.683	251.3
26	1.207	10.898	256.5
27	1.232	11.114	261.6
28	1.256	11.332	266.9
29	1.281	11.552	272.1
30	1.306	11.773	277.4
31	1.331	11.995	282.7
32	1.357	12.220	288.0
33	1.382	12.445	293.3
34	1.408	12.673	298.7
35	1.434	12.902	304.1
36	1.460	13.132	309.5

1 Data source: Test solutions calculated according to DIN IEC 746-3

2 Data source: K. H. Hellwege (Editor), H. Landolt, R. Börnstein: Zahlenwerte und Funktionen ..., volume 2, part. volume 6

Measuring Ranges (01 ... 11)

Substance	Concentration ranges		
NaCl	0-26 wt% (0 °C / +32 °F) 0-26 wt% (+100 °C / +212 °F)		
Configuration	-01-		
HCl	0-18 wt% (-20 °C / -4 °F) 0-18 wt% (+50 °C / +122 °F)	22-39 wt% (-20 °C / -4 °F) 22-39 wt% (+50 °C / +122 °F)	
Configuration	-02-	-07-	
NaOH	0-13 wt% (0 °C / +32 °F) 0-24 wt% (+100 °C / +212 °F)	15-50 wt% (0 °C / +32 °F) 35-50 wt% (+100 °C / +212 °F)	
Configuration	-03-	-10-	
H ₂ SO ₄	0-26 wt% (-17 °C/-1.4 °F) 0-37 wt% (+110 °C/+230 °F)	28-77 wt% (-17 °C/-1.4 °F) 39-88 wt% (+115 °C/+239 °F)	94-99 wt% (-17 °C/-1.4 °F) 89-99 wt% (+115 °C/+239 °F)
Configuration	-04-	-09-	-06-
HNO ₃	0-30 wt% (-20 °C / -4 °F) 0-30 wt% (+50 °C / +122 °F)	35-96 wt% (-20 °C / -4 °F) 35-96 wt% (+50 °C / +122 °F)	
Configuration	-05-	-08-	
H ₂ SO ₄ +SO ₃ (Oleum)	13-45 wt% (0 °C / +32 °F) 13-45 wt% (+120 °C / +248 °F)		
Configuration	-11-		

For the solutions listed above, the device can determine the substance concentration from the measured conductivity and temperature values in % by weight. The measurement error is made up of the sum of measurements errors during conductivity and temperature measurement and the accuracy of the concentration curves stored in the device. We recommend to calibrate the device together with the sensor, eg, directly to concentration using the CAL_CELL method. For exact temperature measurement, you should perform a temperature probe adjustment. For measuring processes with rapid temperature changes, use a separate temperature probe with fast response.

When measuring processes such as dilution or intensification of CIP solutions (Clean-In-Place), it is helpful to switch between the parameter sets for measuring the process medium and for measuring the CIP solution.

-01- Sodium chloride solution NaCl

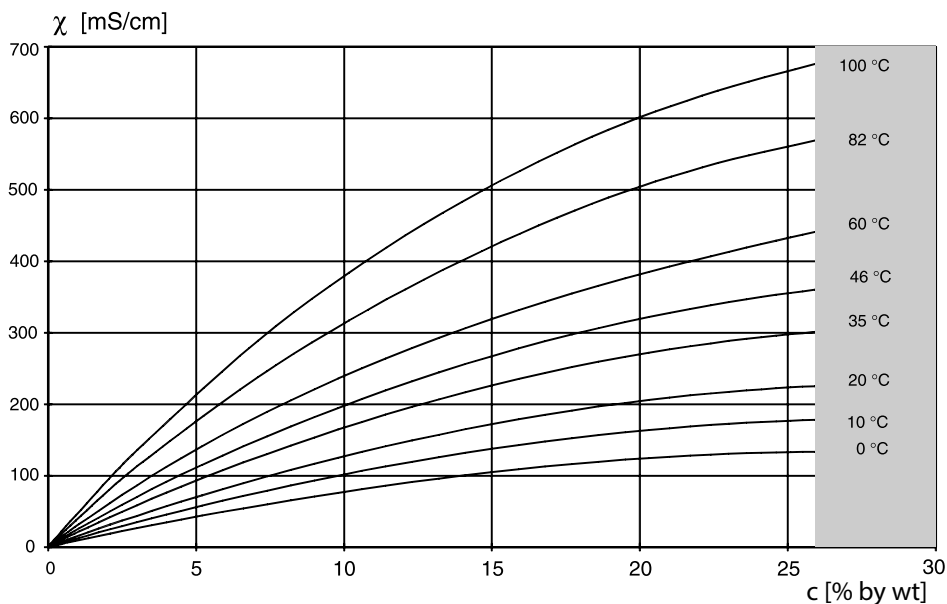
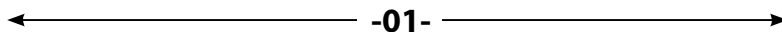

Concentration measurement not possible in this range.

Conductivity versus substance concentration and process temperature for sodium chloride solution (NaCl)

-02- Hydrochloric acid HCl**-07-**

← **-02-** → ← **-07-** →

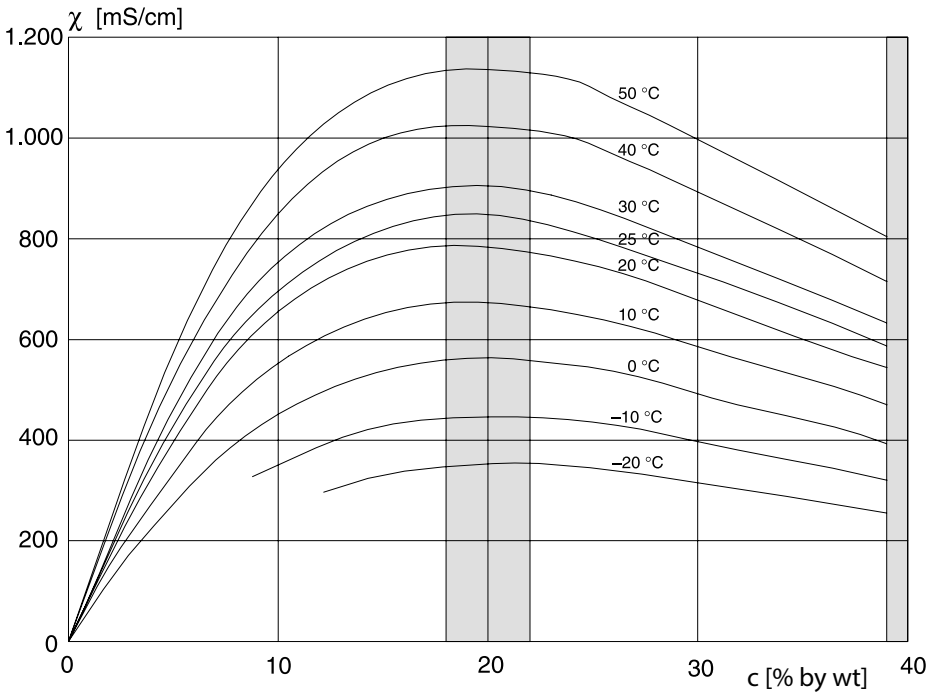

■ Concentration measurement not possible in this range.

Conductivity versus substance concentration and process temperature for hydrochloric acid (HCl)

Source: Haase/Sauermann/Dücker; Z. phys. Chem. New Edition, Vol. 47 (1965)

-04- Sulfuric acid H₂SO₄**-06-****-09-**

← **-04-** → ← **-09-** → **-06-**

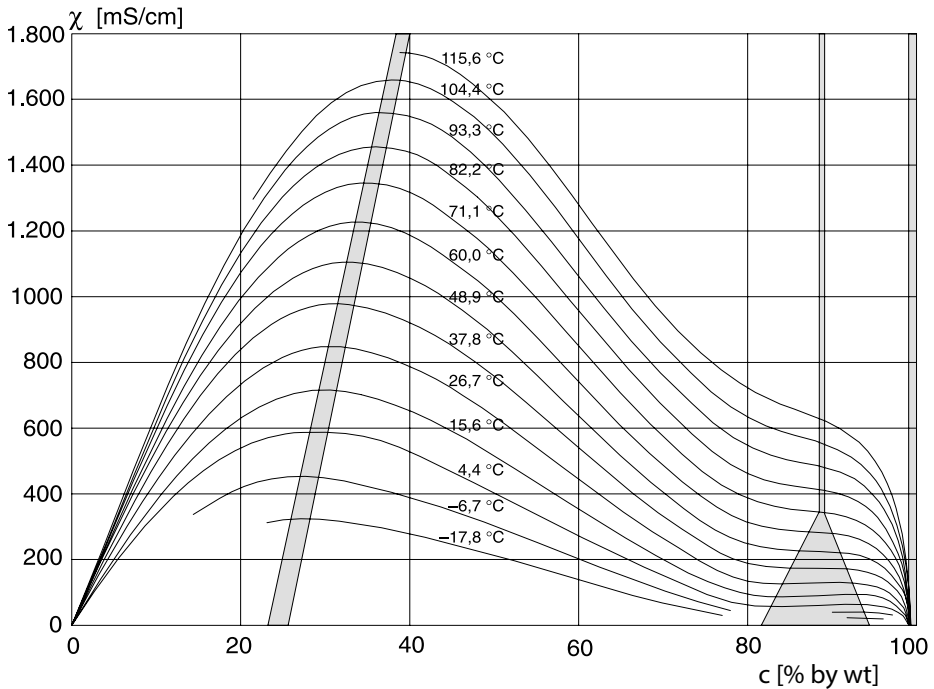

■ Concentration measurement not possible in this range.

Conductivity versus substance concentration and process temperature for sulfuric acid (H₂SO₄)

Source: Darling; Journal of Chemical and Engineering Data; Vol.9 No.3, July 1964

-05- Nitric acid HNO₃

-08-

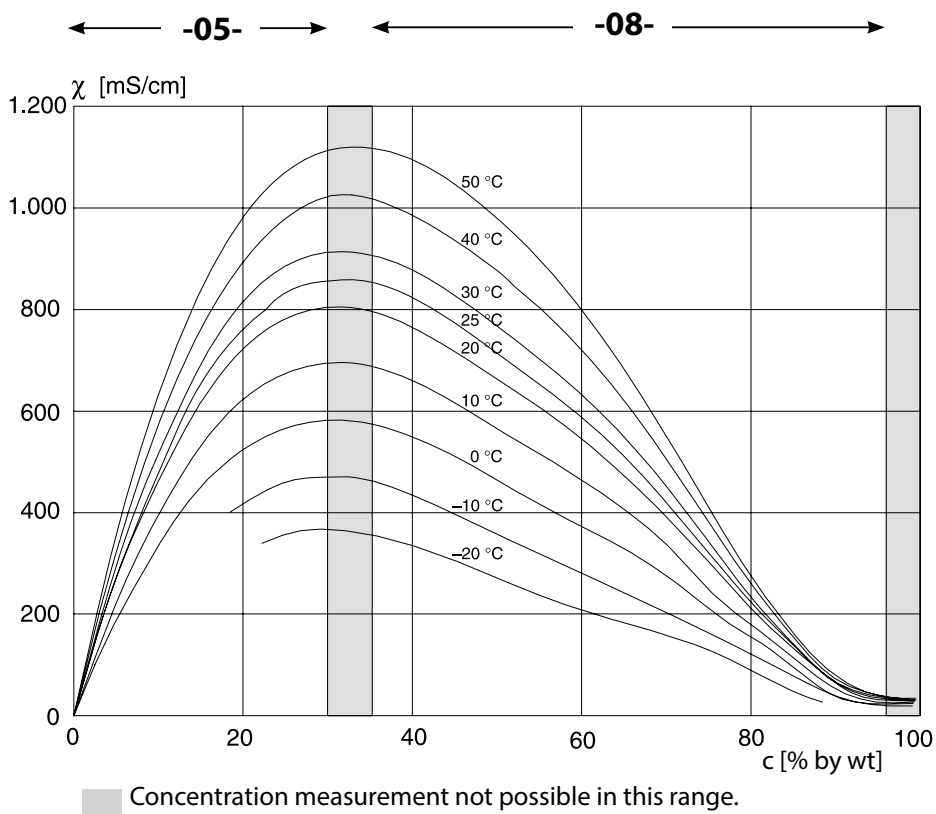

Conductivity versus substance concentration and process temperature for nitric acid (HNO₃)

Source: Haase/Sauermann/Dücker; Z. phys. Chem. New Edition, Vol. 47 (1965)

-11- Oleum $\text{H}_2\text{SO}_4 \cdot \text{SO}_3$

Conductivity
[mS/cm]

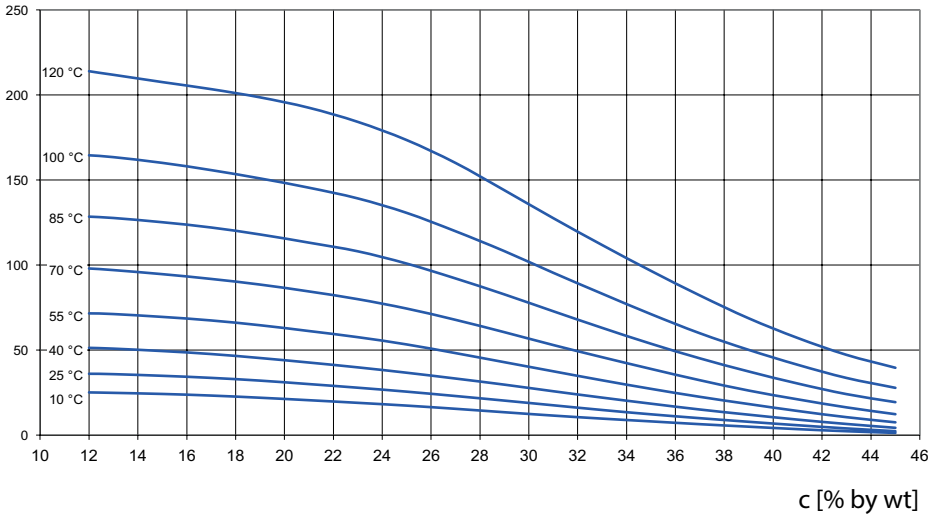

A

Accessories 165
Activate Sensocheck 109
AIR-SET calibration 141
Alarm, contact characteristics 109
Alarm, CONTROL input 110
Alarm, delay 108
Alarm, description 52
Alarm, flow monitoring 110
Alarm, Sensocheck 109
Ambulance TAN if passcode is lost 155
Application example 11
Application in hazardous locations 18
Assembly 12
Assigning measured values, current start/end 93
Audit Trail, viewing entries 150
Autorange 93

B

Backlighting 46
Bilinear curve 95
Buttons and functions 45

C

Cable preparation SE 655 / SE 656 34
Cable type Memosens 22
Calibration 133
Calibration by input of cell factor 140
Calibration data, display 148
Calibration mode 133
Calibration, product calibration 136
Calibration solutions 176
Calibration with calibration solution 134
Calibration, zero point (toroidal sensors) 141
Capacitive loads, protective wiring of relay contacts 118
Channel selection and display assignment (Cond-Cond) 80
Characteristic of output current 94
CIP (Cond) 67
CIP / SIP (CondI) 77
Cleaning contact, configuration 128
Cleaning cycles (Cond) 66
Cleaning cycles (CondI) 76
Colors in display 46
Concentration curves 179

- Concentration measurement, ranges 178
- Concentration solution, configuration (Cond) 60
- Concentration solution, configuration (Condl) 74
- Cond, calibration 134
- Cond-Cond, calculating the pH value 83
- Cond-Cond configuration 84
- Cond-Cond Wiring Examples 41
- Cond, configuration 60
- Condl, calibration 140
- Condl, configuration 72
- Condl wiring examples 35
- Cond, logarithmic curve of output current 94
- Cond wiring examples 25
- Configuration, alarm 108
- Configuration (Cond) 60
- Configuration (Cond-Cond) 84
- Configuration (Condl) 72
- Configuration (Condl), overview 71
- Configuration (Cond), overview 59
- Configuration, controller 124
- Configuration, current output 92
- Configuration, limit function 112
- Configuration, pulse frequency controller (PFC) 125
- Configuration, pulse length controller (PLC) 125
- Configuration, relay contacts 112
- Configuration, Sensocheck 108
- Configuration, TAG/GROUP 130
- Configuration, temperature compensation 102
- Configuration, time and date 130
- Configuration, time averaging filter 98
- Configuration, WASH contact 128
- Connecting a Memosens sensor, menu 57
- Connecting cable, Memosens 22
- Connection length for sensors, maximum (Cond-Cond) 80
- Connection of conductivity sensors, Cond-Cond (examples) 41
- Connection of conductivity sensors, Cond (examples) 25
- Connection of conductivity sensors, Condl (examples) 35
- Consumption calculation of ion exchanger 81
- Contact, alarm, configuring 109
- Control Drawings 6
- CONTROL input, flow measurement 106
- CONTROL input, parameter set selection 104

- Control inputs 9
- Controller characteristic 121
- Controller equations 122
- Controller output/setpoint, display 146
- Current output, configuration 92
- Current start/end, assigning measured values 93

- D**
- Data logger, description 8
- Data logger, viewing entries 150
- Date and time, usage 131
- Date, display 143
- Date, setting 130
- Device self-test 149
- Device start blocked 156
- Device type CC, monitoring function 162
- Device type Cond, configuration 60
- Device type Condl, configuration 72
- Device type, display 151
- Device type, selecting the measuring function 155
- Diagnostics, device self-test 149
- Diagnostics, hardware and software version 151
- Diagnostics, logbook 150
- Diagnostics mode 147
- Diagnostics, sensor monitor 151
- Digital sensors (Condl), select sensor type 73
- Digital sensors (Cond), select sensor type 61
- Dimensions 13
- Display 46
- Display backlighting 48
- Displaying the output currents 143
- Displaying the time/date 143
- Display in measuring mode 47
- Display, selecting the main display 47
- Display test 149
- Disposal 5
- Documentation 6
- Dual conductivity measurement, calculations (CALC) 81
- Dual conductivity measurement, pH value calculation 83
- Dual conductivity measurement, terminal assignments 21
- Dual conductivity measurement, wiring examples 41

E

- EEPROM test, device self-test 149
- Enclosure components 12
- ERR 158
- Error and HOLD, output current 100
- Error messages 158
- Error messages, configure output current 101
- EU Declarations of Conformity 6
- Extended logbook (via TAN) 150

F

- Factory setting, reset 155
- FIRMWARE UPDATE 156
- FLASH test 149
- FLOW 107
- Flow measurement 106
- Flow measurement, alarm 110
- Flow measurement, generate message 52

G

- GROUP of measuring points 131
- GROUP, sensor verification 69, 79

H

- HOLD, behavior of PID controller 123
- HOLD, configure output current 100
- HOLD, exit 51
- HOLD, external activation 51
- HOLD mode 51
- HOLD, output signal during HOLD 51
- HOLD, output signal response 51
- Hysteresis, application 115

I

- Icons 46
- Inductive conductivity measurement, calibration 139
- Inductive conductivity measurement, wiring examples 35
- Inductive loads, protective wiring of relay contacts 118
- Info text 158
- Inserting a module 23
- Installation, terminal assignments 18
- Interchangeable modules, product range 164
- Ion exchanger 81

K

Keypad 45

L

Limit value 1, relay 112

Limit value 2, relay 116

Logarithmic curve of output current 96

Logbook 150

M

MAIN DISPLAY 47

Measured values, display 151

Measuring function (device type) 155

Measuring mode 143

Measuring mode, general 44

Measuring module, conductivity (Cond) 24

Measuring module, conductivity (CondI) 33

Measuring module, dual conductivity 40

Measuring modules, product range 164

Measuring point, arrangement (Cond-Cond) 80

Measuring point, TAG/GROUP 130

Measuring ranges, concentration 178

Measuring task conductivity, wiring examples 25

Measuring task dual conductivity, wiring examples 41

Measuring task inductive conductivity, wiring examples 35

Memosens cable 21

Memosens cable (specifications, order code) 22

Memosens Cond wiring examples 32

Memosens sensor (connection, menu) 57

Memosens sensor (connection, terminal assignments) 19

Memosens sensor, replacement 58

Memosens sensor, start-up 20

MemoSuite software for calibrating Memosens sensors 20

Menu groups (configuration) 54

Menus, overview 53

Messages, alarm and HOLD 52

Message via CONTROL input 52

Module for conductivity measurement (Cond) 24

Module for conductivity measurement (CondI) 33

Module for dual conductivity measurement 40

Module, inserting 23

Modules, product range 164

- Module test 149
- Monitoring function for device type CC 162
- Monitoring the sensor lines 90
- Monitoring the temperature probe 109
- Mounting accessories 13
- Mounting accessories, product range 165
- Mounting plan 13

N

- Neutral zone, controller 121

O

- Operating error FIRMW UPDATE 156
- Operating mode, selection 49
- Operating modes, overview 53
- Operating modes, short description 50
- Operating states 163
- Operation, general 44
- Options, enabling 155
- Order codes 164
- Output current, characteristic 94
- Output current during Error and HOLD 100
- Output current, logarithmic curve 96
- Output current, range 93
- Output current, time averaging filter 98
- Output current value, Service mode 154
- Output filter, time interval 98
- Output signal, controller behavior 126
- Output signal during HOLD 101
- Output voltage, adjusting (POWER OUT) 153
- Overview of configuration 86
- Overview of parameter sets 55

P

- Package contents, complete 12
- Package contents, documentation 6
- Panel mounting 15
- Panel-mount kit 15
- Parameter set A/B, display 143
- Parameter set A/B, introduction 8
- Parameter set A/B, overview of menu groups 55
- Parameter set A/B, signaling via WASH contact 56
- Parameter set A/B, switchover 55
- Parameter set selection, configuration 104
- Passcode lost 155

Passcodes, assigning and editing 155
PFC, pulse frequency controller 123
pH value calculation 83
PID controller and behavior during HOLD 123
PID controller, configuration 124
PID controller, description 121
Pipe mounting 14
Pipe-mount kit 14
PLC, pulse length controller 123
Potassium chloride solutions, table 176
POWER OUT, adjusting the output voltage 153
Power supply, connection 19
Power supply ratings 19
Process variable not loaded 156
Process variable selection 93
Product calibration 136
Product range 164
Protective hood 14
Protective wiring of relay contacts 118
Pulse frequency controller (PFC) 123
Pulse frequency controller (PFC), configuration 125
Pulse length controller (PLC) 123
Pulse length controller (PLC), configuration 125

Q

Quickstart guides 6

R

RAM test 149
Rating plates 17
Relay 1 112
Relay 2 116
Relay contacts, configuration 112
Relay contacts, protective wiring 118
Relay contacts (schematic) 10
Relay test 154
Release of options 155
Reset to factory settings 155
Return of products under warranty 5

S

- Safety instructions 6
- Sensocheck, configuration 108
- Sensocheck, description 162
- Sensoface, configure output current 101
- Sensoface, description 162
- Sensoface messages, overview 161
- Sensor connection, analog sensors 23
- Sensor connection, Memosens 19
- Sensor data, display 147
- Sensor lines, monitoring 90
- Sensor monitor, Service mode 153
- Sensor replacement 58
- Sensor verification (TAG, GROUP) 68, 78
- Serial number, display 151
- Series resistors 118
- Service, activating an option 155
- Service, factory settings 155
- Service life of contacts 118
- Service mode 152
- Service passcode lost 155
- Service, passcodes 155
- Service, relay test 154
- Service, sensor monitor 153
- Service, specifying the current outputs 154
- Setting the passcodes 155
- Signal colors 48
- SIP (Cond) 67
- SIP (Condl) 77
- Sodium chloride solutions, table 177
- Software for calibrating Memosens sensors 20
- Software version, display 151
- Specifications 166
- Specifications, Memosens cable 22
- Specific test report 6
- Start and end values for logarithmic curve 97
- Start-up, measuring function 23
- Start-up with Memosens sensor 20
- Sterilization cycles (Cond) 66
- Sterilization cycles (Condl) 76

T

- TAG, display 143
- TAG of measuring point 131
- TAG, sensor verification 69, 79
- TAN options, activation 155
- TAN options, overview 164
- Tempcheck 108
- Temperature compensation 102
- Temperature measurement (Cond) 65
- Temperature probe adjustment 138
- Temperature probe, monitoring 109
- Temperature probe selection (Cond) 65
- Temperature unit 74
- Terminal assignments 19
- Terminal plate of conductivity module (Cond) 24
- Terminal plate of conductivity module (CondI) 33
- Terminal plate of device 17
- Terminal plate of dual-conductivity module 40
- Terminals 19
- Time and date, usage 131
- Time averaging filter 99
- Time, display 143
- Time format, setting 130
- Time, setting 130
- Toroidal sensors, calibration 139
- Toroidal sensors, configuration 71

U

- USP function 62

W

- WASH contact (configuration) 128
- WASH contact (signaling parameter set) 56
- Wiring 19
- Wiring examples, Memosens Cond 32
- Wiring of conductivity sensors (examples) 25

Z

- Zero calibration (CondI) 141

Knick
Elektronische Messgeräte GmbH & Co. KG

Beuckestraße 22
14163 Berlin
Germany

Phone: +49 30 80191-0
Fax: +49 30 80191-200
Web: www.knick.de
Email: info@knick.de

Stratos Evo A402: Conductivity Measurement

TA-212.101-cd-KNE02 20170831



Software version: 1.x