

User Manual
English

Stratos Evo A402 pH Measurement

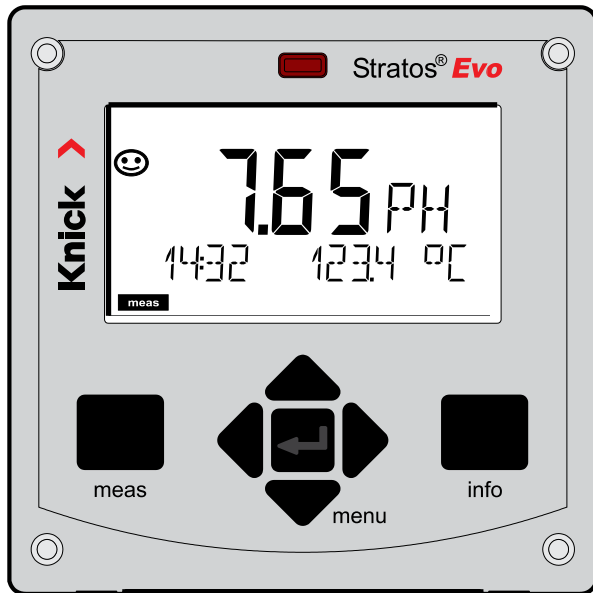

| | |
|---|-----------|
| Basics | 7 |
| Documents Supplied | 8 |
| Introduction | 9 |
| Overview of the Stratos Evo | 14 |
| Modular Concept..... | 18 |
| Terminal Plate and Rating Plates | 19 |
| Power Supply, Signal Assignments..... | 20 |
| Installation | 21 |
| Start-Up | 23 |
| Changing the Measuring Function | 23 |
| Inserting a Module | 24 |
| pH Module..... | 25 |
| pH Wiring Examples | 26 |
| Memosens Sensors | 34 |
| Operation | 40 |
| The Keys and Their Functions | 41 |
| The Display | 42 |
| Display in Measuring Mode..... | 43 |
| Color-Coded User Interface | 44 |
| Selecting the Mode / Entering Values..... | 45 |
| Operating Modes | 46 |
| Overview of Configuration | 50 |
| Switching Parameter Sets A/B | 51 |
| Signaling Parameter Set..... | 52 |
| Connecting a Memosens Sensor | 53 |
| Configuring a pH Sensor | 55 |
| Memosens: Dual Devices | 75 |
| Device Type: MSPH-MSPH..... | 76 |
| Device Type: MSPH-MSOXY | 79 |

| | |
|--|------------|
| Overview of Configuration | 82 |
| Configuring the Current Output..... | 86 |
| Temperature Compensation | 92 |
| Configuring the CONTROL Input..... | 94 |
| Configuring the Alarm..... | 98 |
| Configuring the Relay Contacts | 102 |
| Protective Wiring of Relay Contacts..... | 108 |
| PID Controller | 111 |
| Configuring the WASH Contact..... | 118 |
| Configuring the Time/Date..... | 120 |
| Calibration | 122 |
| Zero Adjustment..... | 124 |
| pH: Automatic Calibration..... | 126 |
| pH: Manual Calibration | 128 |
| pH: Premeasured Sensors..... | 130 |
| Slope: Converting % to mV..... | 131 |
| ORP (Redox) Calibration..... | 132 |
| Product Calibration..... | 134 |
| Measurement | 136 |
| Diagnostics | 140 |
| Service | 145 |
| Operating Error!..... | 149 |
| Error Messages..... | 151 |
| Sensocheck and Sensoface | 155 |
| Operating States..... | 156 |
| Product Range | 157 |

| | |
|--------------------------------------|------------|
| Specifications | 159 |
| Buffer Tables | 165 |
| -01- Mettler-Toledo | 165 |
| -02- Knick CaliMat | 166 |
| -03- Ciba (94) buffers | 167 |
| -04- Technical buffers to NIST | 168 |
| -05- NIST standard buffers | 169 |
| -06- HACH buffers | 170 |
| -07- WTW techn. buffers..... | 171 |
| -08- Hamilton Duracal buffers | 172 |
| -09- Reagecon buffers | 173 |
| -10- DIN 19267 buffers | 174 |
| -U1- Specifiable Buffer Set | 175 |
| Index | 178 |

Safety Instructions

In official EU languages and others

Quickstart Guides

Installation and first steps:

- Operation
- Menu structure
- Calibration
- Error messages and recommended actions

Specific Test Report

Electronic Documentation

Manuals + Software

Ex Devices:

Control Drawings

EU Declarations of Conformity

Up-to date documentation available on our website:



Stratos Evo is a 4-wire analyzer for process analysis applications.

The analyzer comes as basic device for measurement with digital sensors

(Memosens, optical oxygen measurement, inductive conductivity measurement).

All measuring functions are stored in an internal memory. You select a measuring function to configure the analyzer for a specific measuring task. Additional measuring modules can be connected to allow measurement with analog sensors.

The Model A402B allows applications in hazardous-area Zone 2.

Current is provided through a universal power supply 80 ... 230 V AC, 45 ... 65 Hz / 24 ... 60 V DC. The analyzer provides two 0 (4) ... 20 mA current outputs for transmission of measured value and temperature, for example. Four floating relay contacts are available for free configuration. A PID controller and a time-controlled cleaning function can be configured. Two parameter sets are provided. You can externally switch between them via the Control input, for example. The HOLD input allows setting the HOLD mode from the outside. The analyzer also provides power supply and allows signal processing for additional transmitters, e.g., for flow monitoring.

You can select one of the following measuring functions:

- pH
- ORP
- Oxygen
- Oxygen, optical
- Conductivity measurement (conductive/inductive)
- Dual conductivity measurement using two analog sensors
- Dual measurement of pH/pH and pH/Oxy using two Memosens sensors

Enclosure and mounting possibilities

- The sturdy molded enclosure is rated IP 67/NEMA 4X outdoor.

Material of front unit: PBT, rear unit: PC.

Dimensions: H 148 mm, W 148 mm, D 117 mm.

It is provided with knockouts for:

- panel mounting (138 mm x 138 mm cutout to DIN 43700)
- wall mounting (with sealing plugs to seal the enclosure)
- post/pipe mounting (dia. 40 ... 60 mm, □ 30 ... 45 mm)

Connection of sensors, cable glands

For connecting the cables, the enclosure provides

- 3 knockouts for cable glands M20x1.5
- 2 knockouts for NPT 1/2" or rigid metallic conduit

Display

Plain-text messages in a large, backlit LC display allow intuitive operation. You can specify which values are to be displayed in standard measuring mode ("Main Display").

Color-coded user interface

The colored display backlighting signals different operating states (e.g., alarm: red, HOLD mode: orange).

Diagnostics functions

Diagnostics functions are provided by the "Sensocheck" automatic monitoring of glass and reference electrode and the "Sensoface" function for clear indication of the sensor condition.

Data logger

The internal logbook (additional function, TAN SW-A002) can handle up to 100 entries – up to 200 with AuditTrail (additional function, TAN SW-A003).

2 parameter sets A/B

The device provides two parameter sets which can be switched manually or via a control input for different process adaptations or different process conditions. For an overview of parameter sets (original for copy), refer to the CD or www.knick.de.

Password protection

Password protection (passcode) for granting access rights during operation can be configured.

Automatic calibration with Calimatic

You can choose from the most commonly used pH buffer solutions. In addition, you can enter an individual pH buffer set.

Control inputs

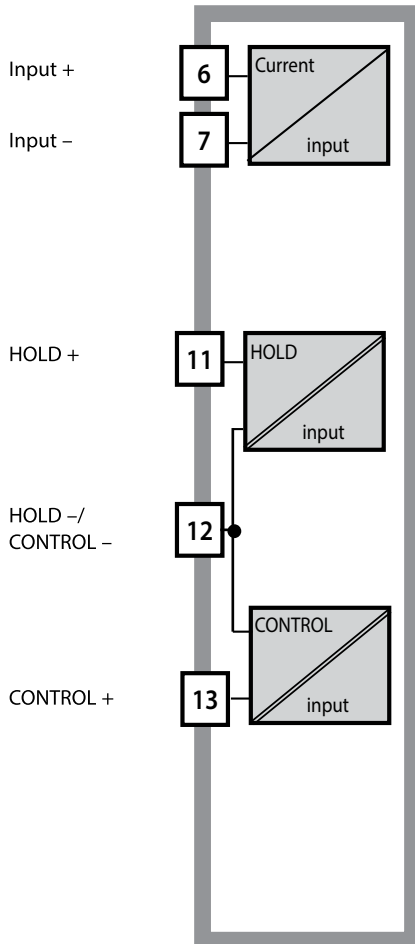

I input

The analog (0) 4 ... 20 mA current input can be used for external pressure or temperature compensation (TAN required).

HOLD

(floating digital control input)

The HOLD input can be used for external activation of the HOLD mode.

CONTROL

(floating digital control input)

The CONTROL input can be used either for parameter set selection (A/B) or for flow monitoring. The "Wash" contact can be used for indicating the active parameter set.

Power supply

Current is provided through a universal power supply 80 ... 230 V AC, 45 ... 65 Hz / 24 ... 60 V DC.

Options

Additional functions can be activated by entering a TAN.

Signal outputs

The analyzer provides two 0 (4) ... 20 mA current outputs for transmission of measured value and temperature, for example.

Relay contacts

Four floating relay contacts are available.

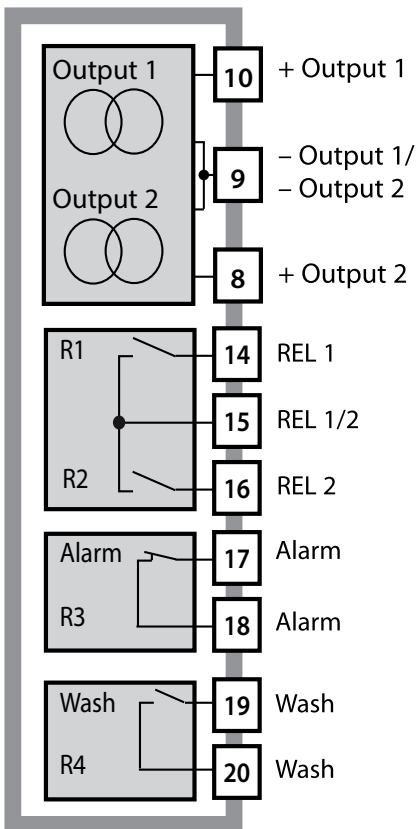

Current outputs

The floating current outputs (0) 4 ... 20 mA are used for transmitting measured values. An output filter can be programmed, the fault current value can be specified.

Relay contacts

2 relay contacts for limit values. Adjustable for the selected process variable: hysteresis, switching behavior (MIN/MAX limit), contact type (N/O, N/C) and delay.

Alarm

An alarm can be generated by Sensocheck, flow monitoring or current failure.

Wash (cleaning function)

This contact can be used for controlling a rinsing probe or for indicating the active parameter set.

PID controller

Configurable as pulse length or pulse frequency controller.

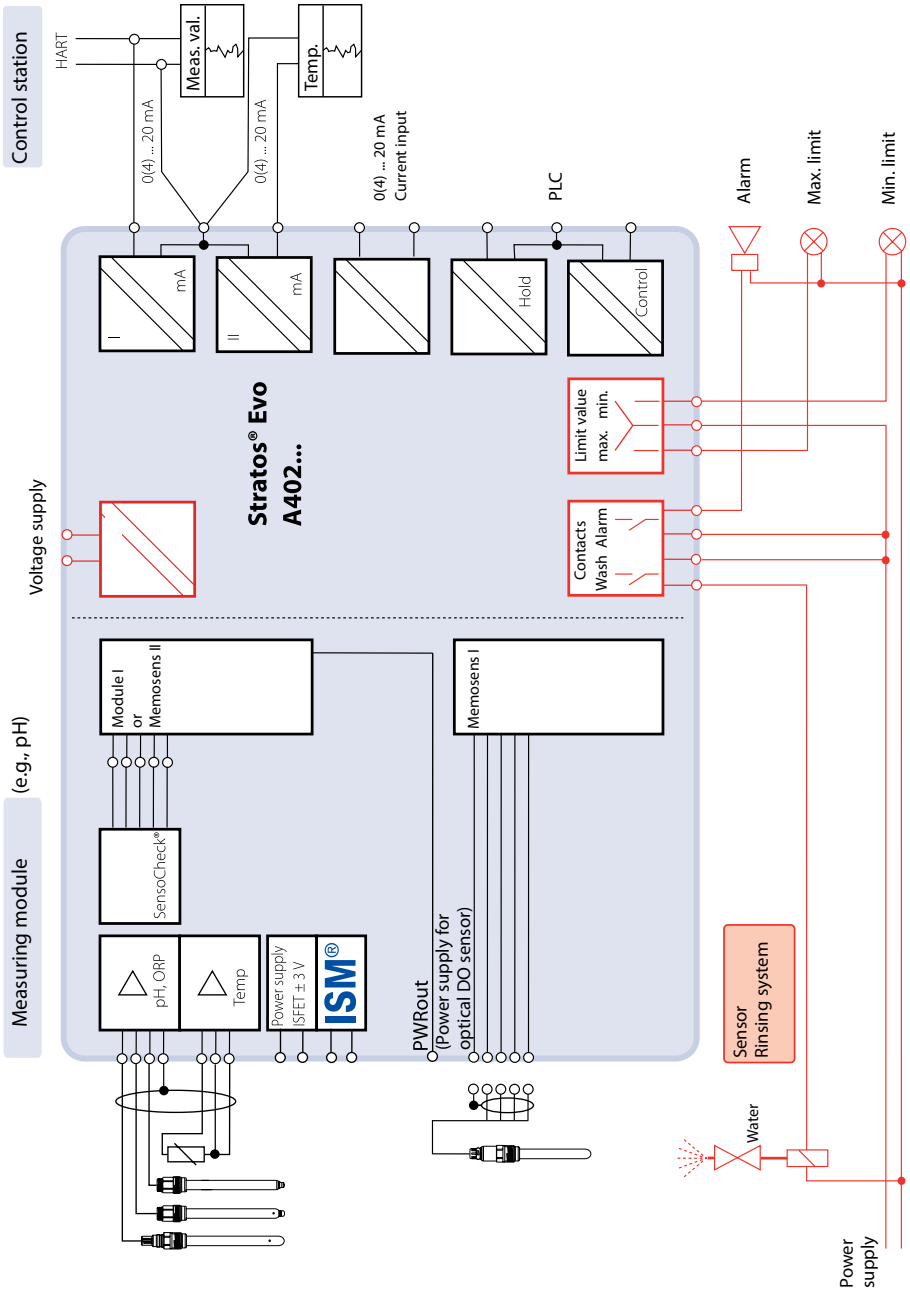

Package Contents

Check the shipment for transport damage and completeness.

The package should contain:

Front unit, rear unit, bag containing small parts

Specific test report

Documentation

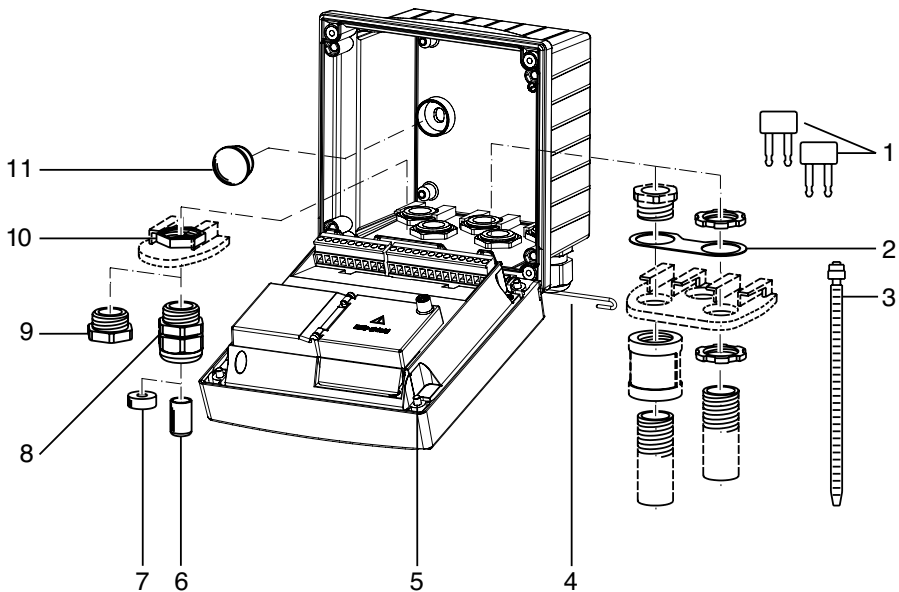
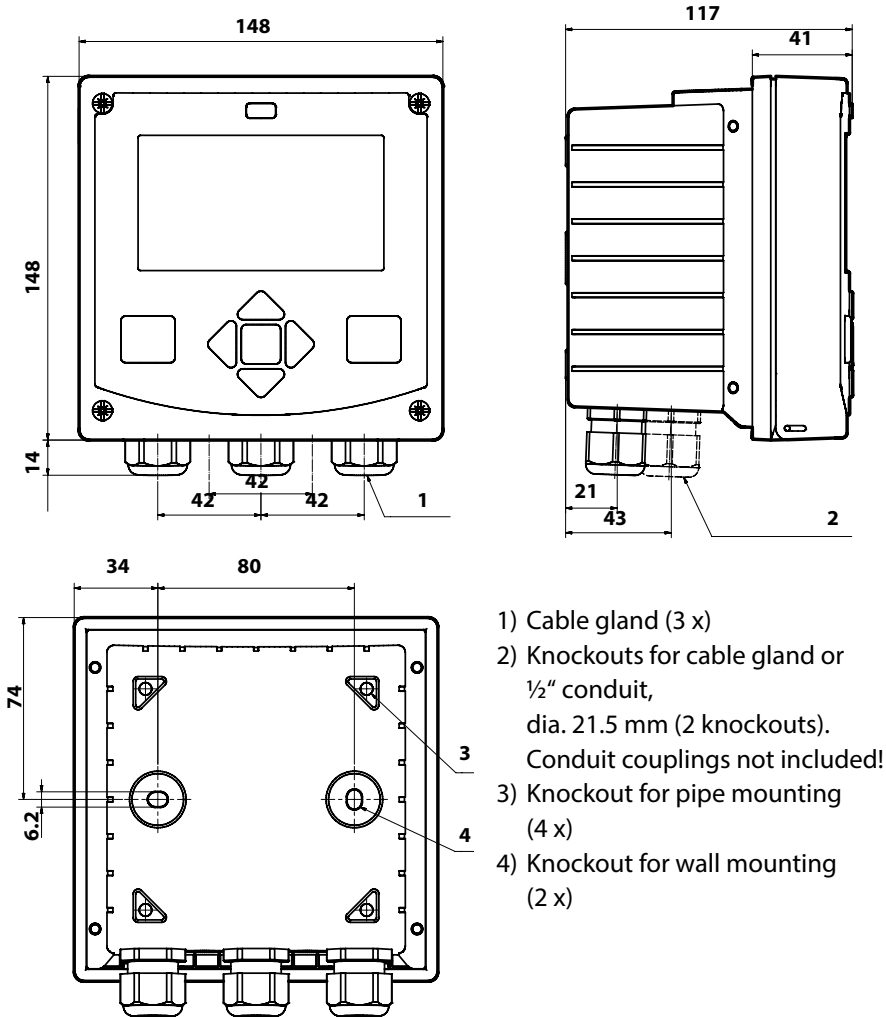

Fig.: Assembling the enclosure

- | | |
|--|--|
| 1) Jumper (3 x) | 6) Sealing insert (1 x) |
| 2) Washer (1 x), for conduit mounting: Place washer between enclosure and nut | 7) Rubber reducer (1 x) |
| 3) Cable tie (3 x) | 8) Cable gland, M20x1.5 (3 x) |
| 4) Hinge pin (1 x), insertable from either side | 9) Filler plug (3 x) |
| 5) Enclosure screw (4 x) | 10) Hexagon nut (5 x) |
| | 11) Sealing plug (2 x), for sealing in case of wall mounting |

Mounting Plan, Dimensions



All dimensions in mm

Mounting Accessories

Pipe-mount kit, accessory ZU 0274

Protective hood for wall and pipe mounting, accessory ZU 0737

Panel-mount kit, accessory ZU 0738

Pipe Mounting, Protective Hood

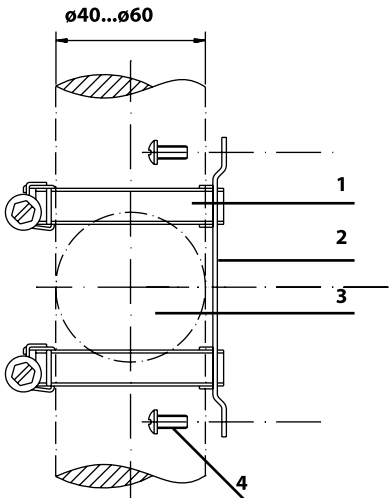

- 1) Hose clamp with worm gear drive to DIN 3017 (2 x)
- 2) Pipe-mount plate (1 x)
- 3) For vertical or horizontal posts or pipes
- 4) Self-tapping screw (4 x)

Fig.: Pipe-mount kit, accessory ZU 0274

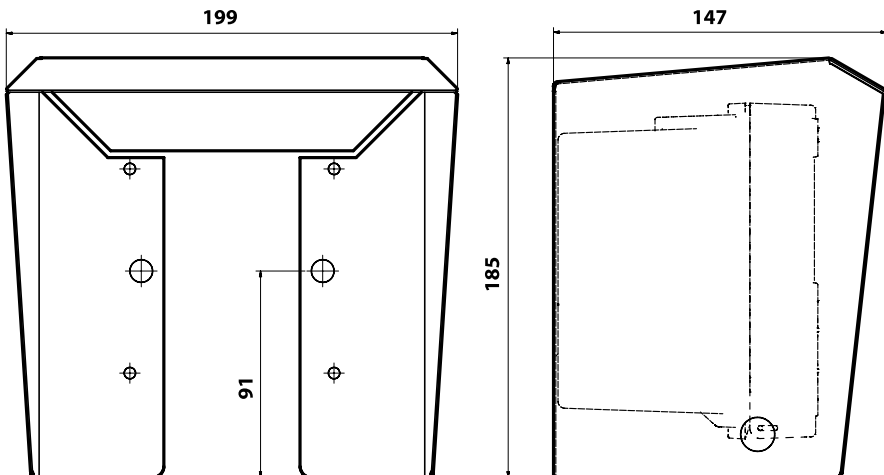
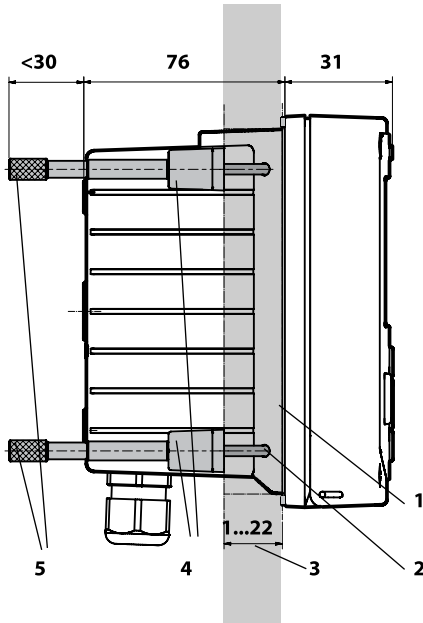

Fig.: Protective hood for wall and pipe mounting, accessory ZU 0737

Panel Mounting



- 1) Circumferential sealing (1 x)
- 2) Screws (4 x)
- 3) Position of control panel
- 4) Span piece (4 x)
- 5) Threaded sleeve (4 x)

Cutout

138 x 138 mm (DIN 43700)

Fig.: Panel-mount kit, accessory ZU 0738

All dimensions in mm

For connection of analog sensors:
Insert interchangeable module (measuring module)

Memosens

RS 485 A

RS 485 B

GND/Shield

PWR out

Power output
3.1/12/15/24V 1 W

Input +

Input -

HOLD +

HOLD -/
CONTROL -

CONTROL +

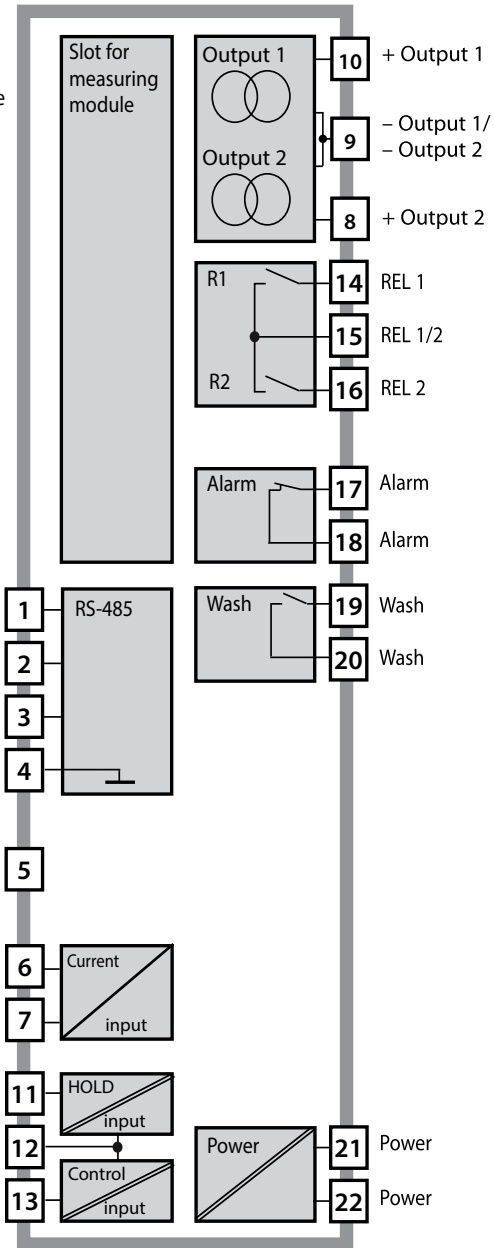

Terminal Assignments

The terminals are suitable for single or stranded wires up to 2.5 mm² (AWG 14).

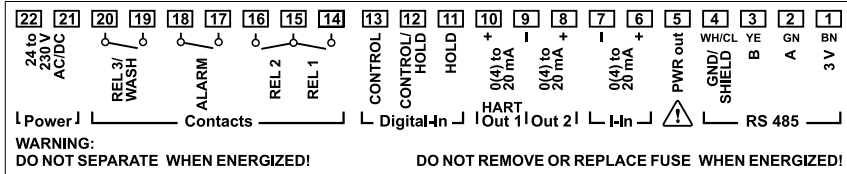

A402N Rating Plate

Knick >

A4*2N



No. 84192/0000000/1233

-20 ≤ T_a ≤ +55 °C
EnclosureType4X

Power

80 (-15%) to 230 (+10%) V AC,
45 to 65 Hz, < 15 VA

24 (-15%) to 60 (+10%) V DC,
= 10 W

D-14163Berlin Made in Germany

A402B Rating Plate

Knick > 

Knick SC91214A see Control drawing 212.002-100

II 3 G Ex nA [ic] IIC T4 Gc II 3 D Ex tc [ic] IIB T85°C Dc IP5x

A4*2B



No. 81193/0000000/1233

-20 ≤ T_a ≤ +55 °C
Enclosure Type 4X

IECEX KEM 08.0020 see Control drawing 212.002-100

Ex nA [ic] IIC T4 Gc Ex tc [ic] IIB T85°C Dc IP5x

PWR: 80 (-15%) to 230 (+10%) V AC, 45 to 65 Hz, < 15 VA
24 (-15%) to 60 (+10%) V DC, = 10 W

D-14163Berlin Made in Germany

Power Supply

Connect the power supply for Stratos Evo to terminals 21 and 22
(24 ... 230 V AC, 45 ... 65 Hz / 24 ... 80 V DC)

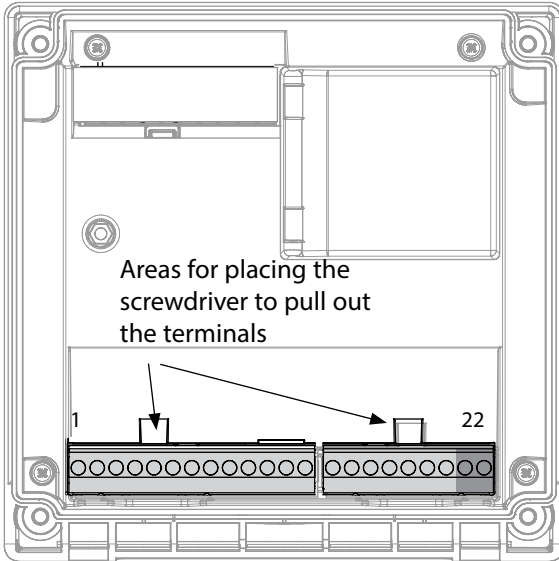

Figure:
Terminals, device opened,
back of front unit

Connecting the Memosens Sensor

Connect the Memosens sensor to the RS-485 interface of the device.

Then select the measuring function. (When you change to another sensor type, you can change the measuring function in the "Service" menu.)

When you select the sensor in the Configuration menu, the calibration data are read from the sensor. They can later be modified by calibration.

Terminal assignments

Memosens connection

| | | |
|--------|------------|----------------|
| 1 (BN) | +3 V | Brown |
| 2 (GN) | RS 485 A | Green |
| 3 (YE) | RS 485 B | Yellow |
| 4 (WH) | GND/shield | White / Shield |

| | |
|---|-----------|
| 5 | Power Out |
| 6 | + input |
| 7 | - input |

Current outputs OUT1, OUT2

| | |
|----|--------------------------|
| 8 | + Out 2 |
| 9 | - Out 2 / - Out 1 / HART |
| 10 | + Out 1 / HART |
| 11 | HOLD |
| 12 | HOLD / Control |
| 13 | Control |

Relay contacts REL1, REL2

| | |
|----|---------|
| 14 | REL 1 |
| 15 | REL 1/2 |
| 16 | REL 2 |
| 17 | alarm |
| 18 | alarm |
| 19 | wash |
| 20 | wash |

Power supply

| | |
|----|-------|
| 21 | power |
| 22 | power |

Installation Instructions

- Installation of the device must be carried out by trained experts in accordance with this user manual and as per applicable local and national codes.
- Be sure to observe the technical specifications and input ratings during installation!
- Be sure not to notch the conductor when stripping the insulation!
- Before connecting the device to the power supply, make sure that its voltage lies within the range 80 to 230 V AC/DC or 24 to 60 V DC.
- A signal current supplied to the current input must be galvanically isolated. If not, connect an isolator module.
- All parameters must be set by a system administrator prior to commissioning.

Terminals

suitable for single or stranded wires up to 2.5 mm² (AWG 14)

Application in Hazardous Locations



When using the device in a hazardous location, observe the specifications of the Control Drawing.

Start-Up

Upon initial start-up, the analyzer automatically recognizes a connected module and adjusts the software correspondingly. When you replace the measuring module, you must select the corresponding measuring function in the “Service” menu.

This does not apply to the multi-channel module for dual conductivity measurement and to the connection of Memosens sensors. Here, you will be prompted to select the desired measuring function upon first start-up.

Changing the Measuring Function

In the “Service” menu you can select another measuring function at any time.

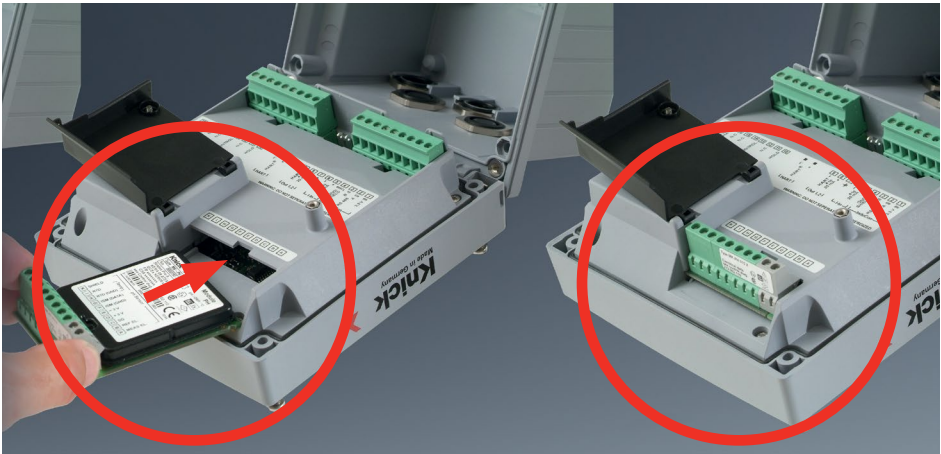

Measuring modules for connection of analog pH sensors:

The measuring module for the connection of analog pH sensors is simply inserted into the module slot. Upon initial start-up, the analyzer automatically recognizes the module and adjusts the software correspondingly. When you replace the measuring module, you must select the corresponding measuring function in the “Service” menu.

Measuring module for 2nd Memosens channel

If you want to measure two process variables using Memosens sensors, you must insert a Memosens module for the second channel. The operating mode for multi-channel measurement (“device type”) must be selected in the configuration menu.

The following combinations are possible:

Memosens pH + Memosens pH

Memosens pH + Memosens Oxy

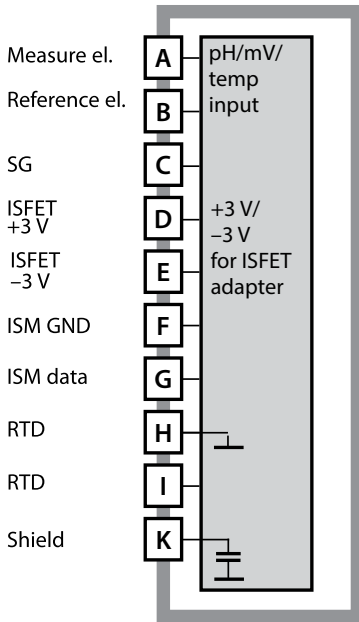

Module for pH measurement

Order code MK-PH015...

See the following pages for wiring examples.

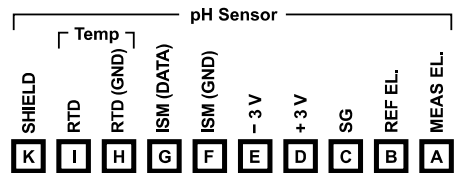

Terminal plate of pH module

The terminals are suitable for single or stranded wires up to 2.5 mm² (AWG 14).

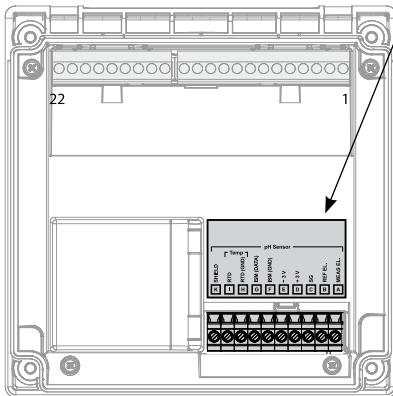

The measuring module comes with a self-adhesive label.

Stick the label to the module slot on the device front. This way, you have the wiring "under control".

Example 1:

Measuring task: pH, temperature, glass impedance
 Sensors (example): SE 555X/1-NS8N
 Cable (example): ZU 0318

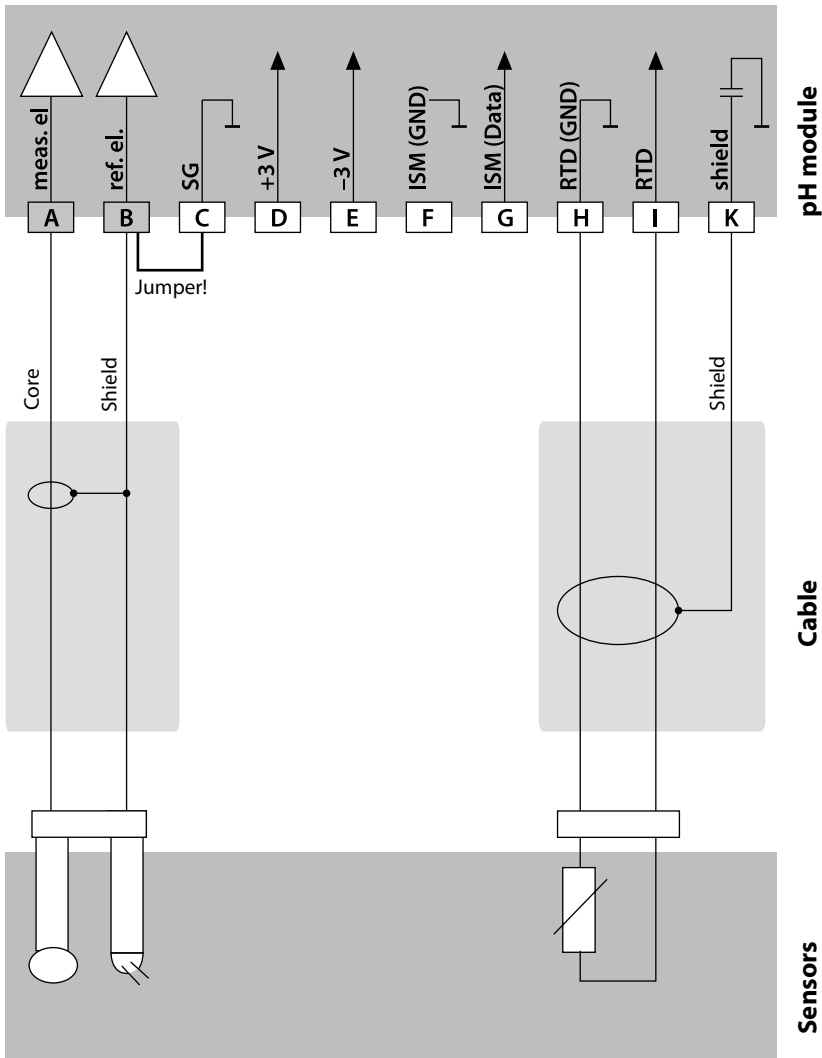

Example 2:

Measuring task:

pH/ORP, temp, glass impedance, ref. impedance

Sensors (example):

SE555X/1-NS8N, equipotential bonding: ZU 0073

Temperature: e.g., Pt1000

Cable (example):

2x ZU 0318

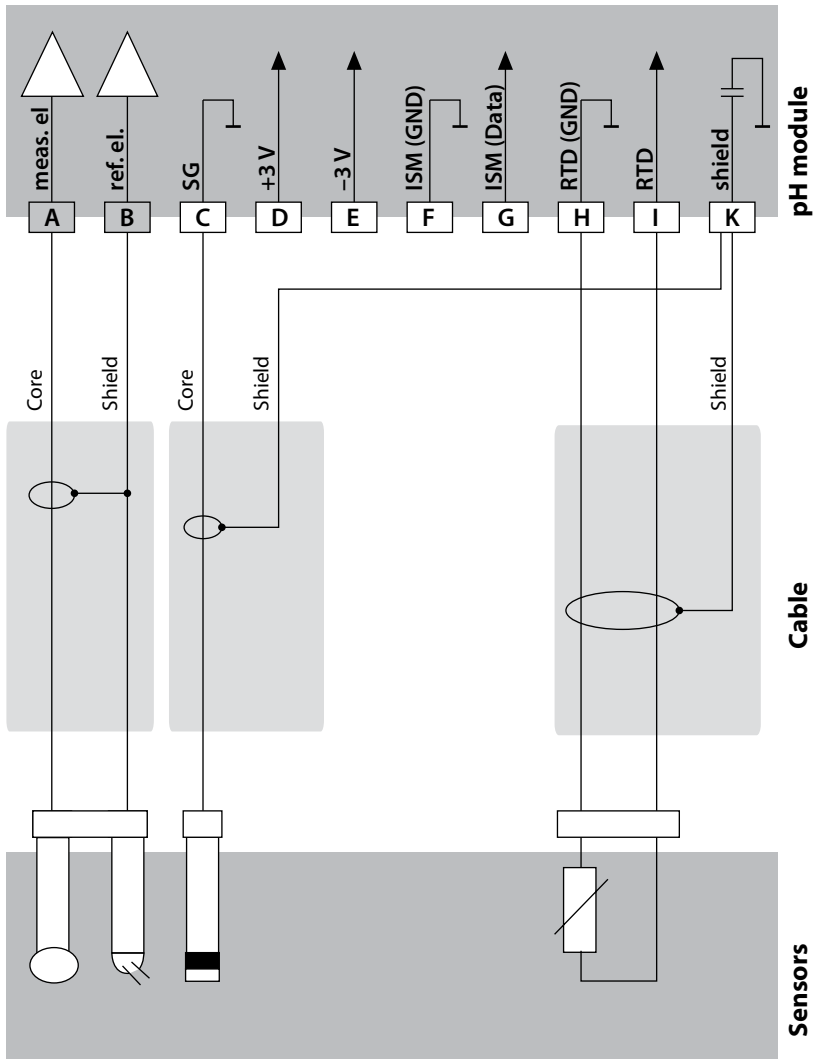

Example 3:

Measuring task: pH, temp, glass impedance
 Sensor: pH sensor, e.g., SE 554X/1-NVPN, cable CA/VP6ST-003A
 Temperature detector: Integrated

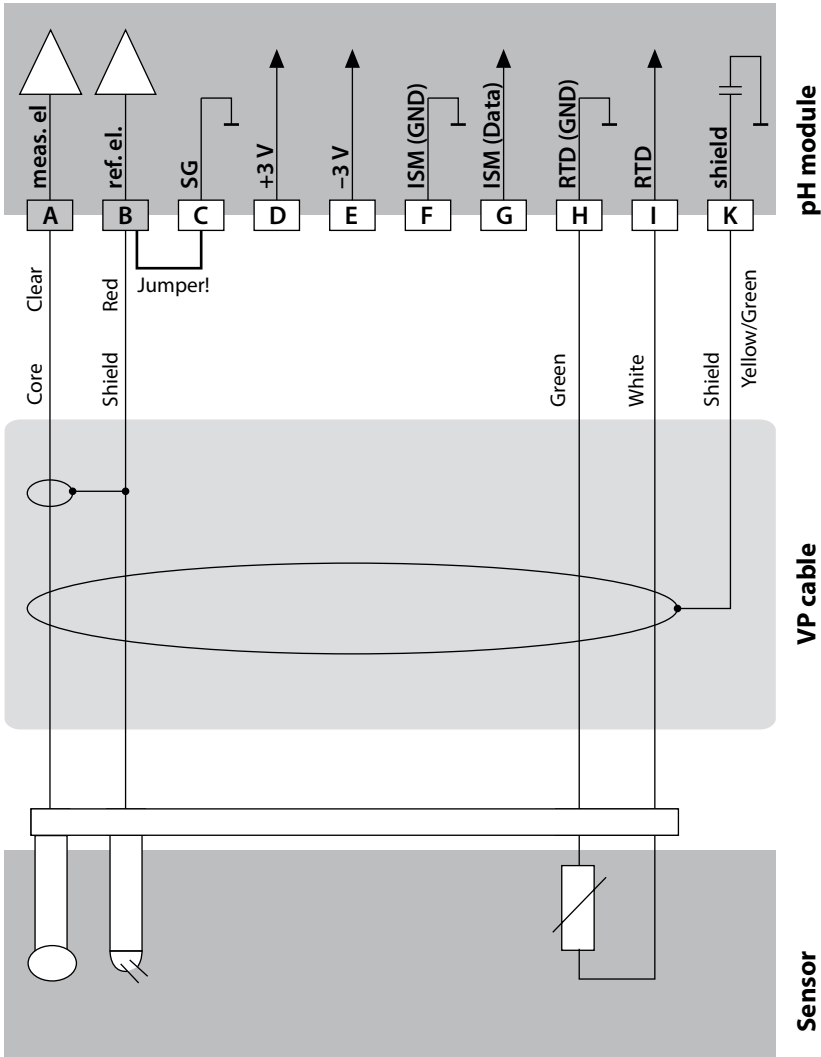

Example 4:

Measuring task:

pH/ORP, temp, glass impedance, ref. impedance

Sensors (example):

pH sensor, e.g., SE 555X/1-NVFN,
cable CA/VP6ST-003A

Temperature detector:

Integrated

Equipotential bonding electrode: ZU 0073, cable: ZU 0318

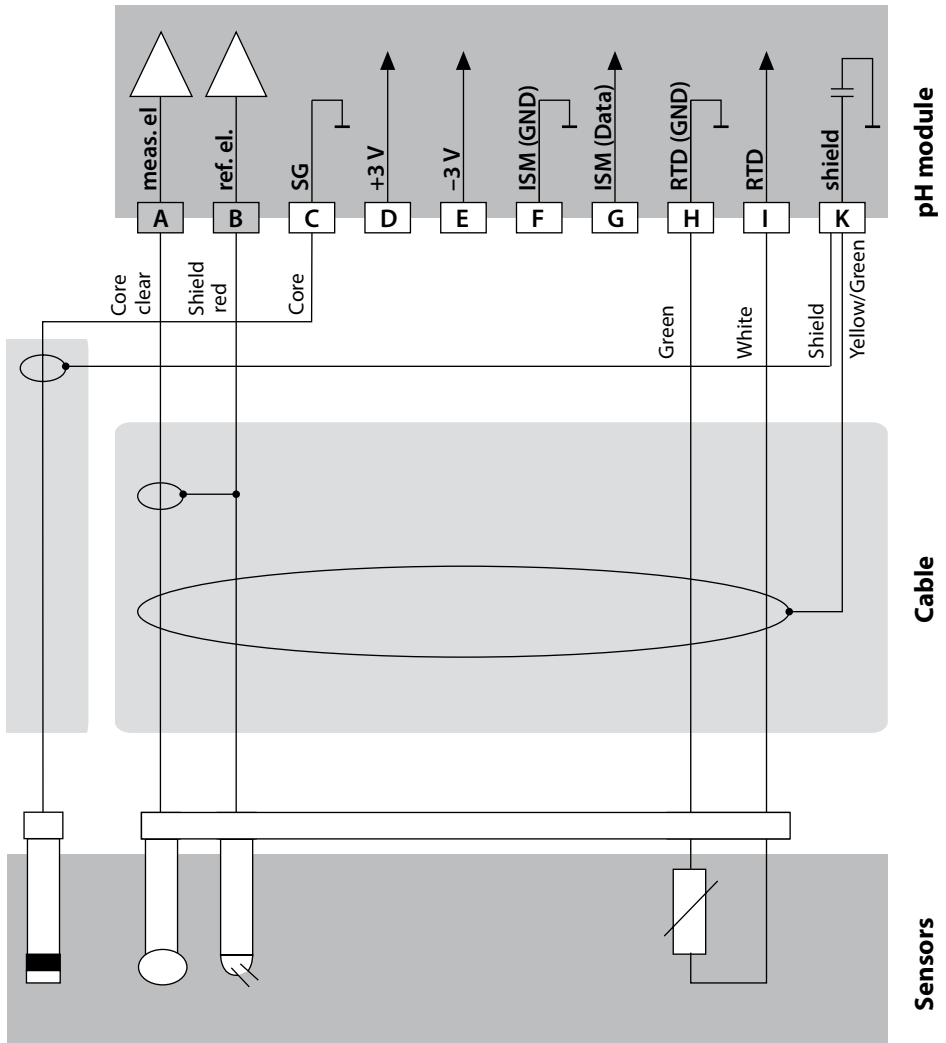

Example 5:

Measuring task: pH/ORP, temp, glass impedance, ref. impedance
 Sensors (example): PL PETR-120VP (pH/ORP combo sensor, SI Analytics)
 Cable (example): CA/VP6ST-003A

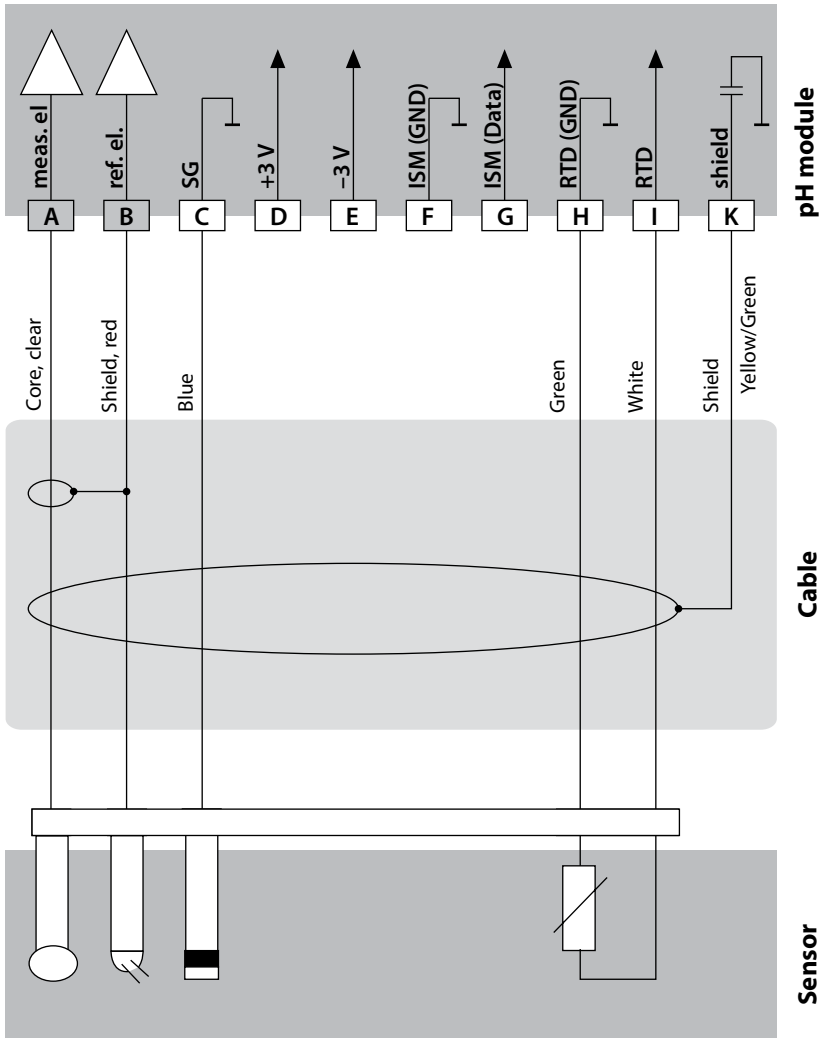

Example 7:

NOTICE!

Do not connect an additional analog sensor!

Measuring task: pH/ORP, temp, glass impedance, ref. impedance

Sensors (example): InPro 4260i (ISM sensor, Mettler-Toledo)

Cable (example): AK9 (Mettler-Toledo)

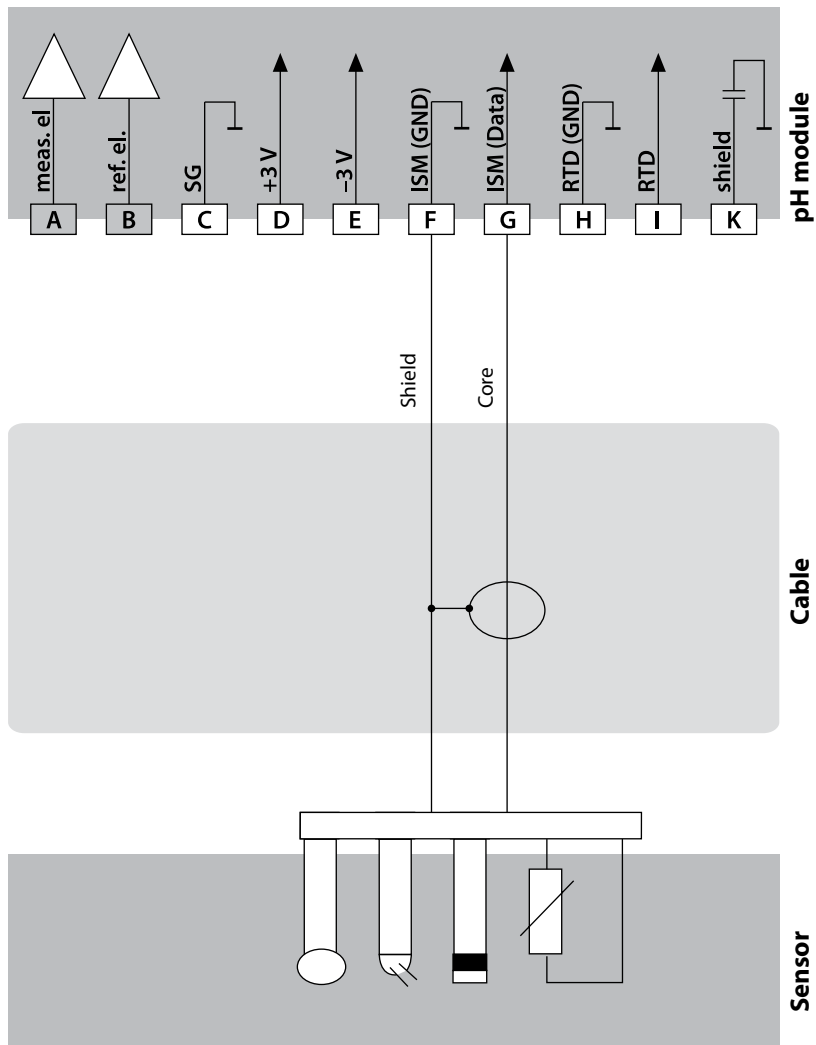

Example 8 - Note: Switch off Sensocheck!

Measuring task: ORP, temp, glass impedance, ref. impedance
 Sensors (example): ORP: SE 564X/1-NS8N
 Cable (example): ZU 0318

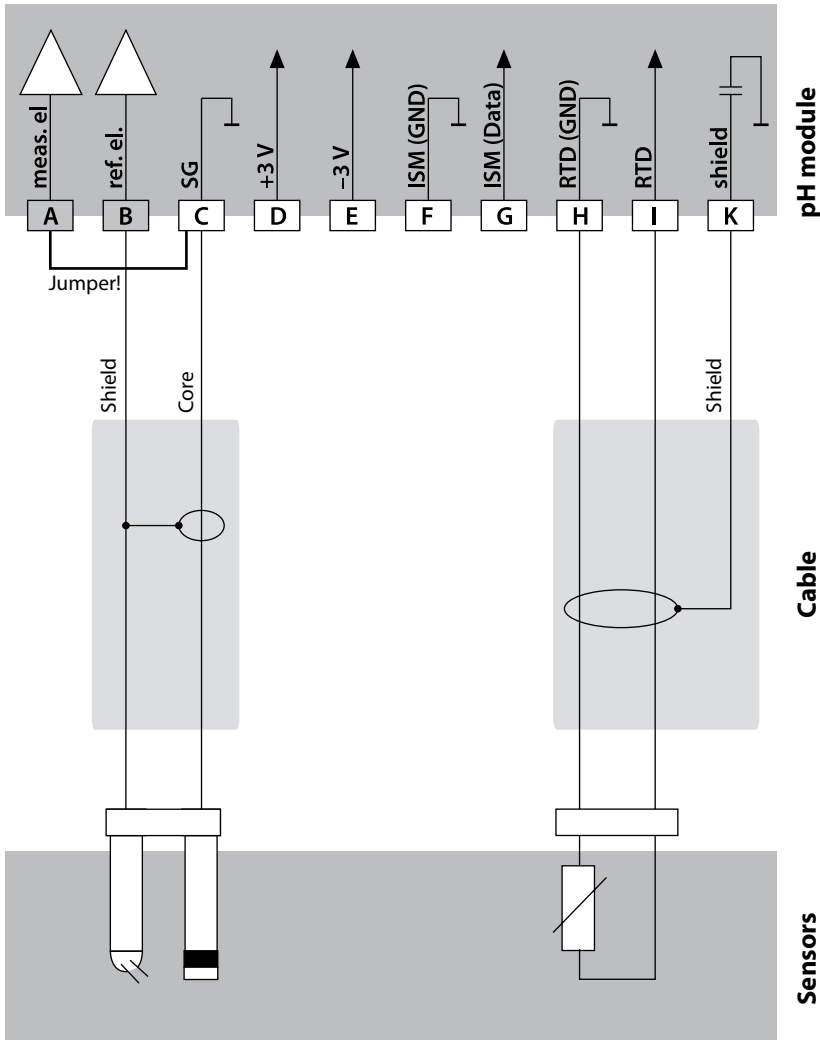

Example 9:

Connecting a Pfaudler probe (requires TAN SW-A007):

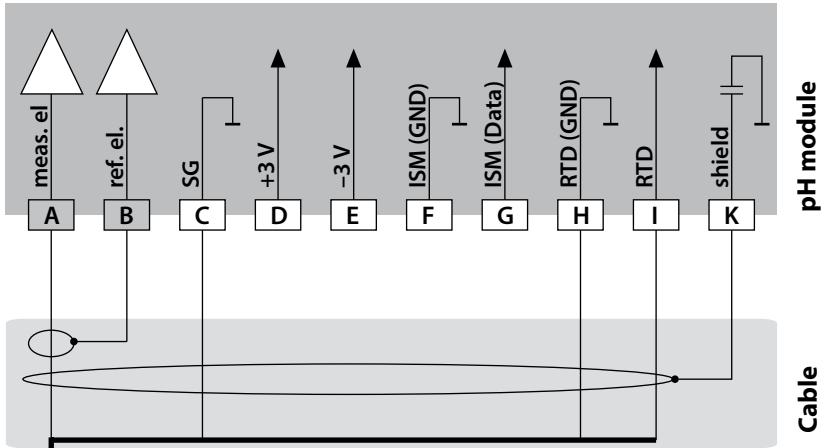

Pfaudler probe

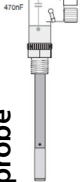

| Module | pH Reiner with equip.bond., VP screw cap | Differential Models 18/40 with equip.bond. | Models 03/04 with equip. bond. | Models 03/04 without equip. bond. |
|--------|--|--|--------------------------------|-----------------------------------|
| A | meas Coax core | Coax white | Coax white | Coax white |
| B | ref Coax shield | Coax brown | Coax brown | Coax brown |
| C | SG Blue | Blue | Blue | Jumper B/C |
| D | | | | |
| E | | | | |
| F | | | | |
| G | | | | |
| H | RTD (GND) Green | Brown | Brown | Brown |
| I | RTD White | Green, Black | Green, Black | Green, Black |
| K | Shield Green/Yellow, Gray | Orange, Violet | Orange, Violet | Orange, Violet |

Start-Up

When you start up the analyzer for the first time, you will be prompted to select the desired measurement procedure (a connected Memosens sensor will not be identified automatically).

Changing the Measuring Function

In the "Service" menu you can select another measuring function at any time.

Calibration and Maintenance in the Lab

The "MemoSuite" software allows calibrating Memosens sensors under reproducible conditions at a PC in the lab. The sensor parameters are registered in a database. Documenting and archiving meet the demands of FDA CFR 21 Part 11. Detailed reports can be output as csv export for Excel. MemoSuite is available as accessory and comes in the versions "Basic" and "Advanced": www.knick.de.

Settings and specifications

Connected sensor: sensor type, manufacturer, order code and serial number

Function selection:
The selected function is highlighted.

Connected sensor: sensor type, manufacturer, order code and serial number, measuring point and tag number

Last adjustment

You can magnify a measured-value display at a click of the mouse.

The screenshot displays the MemoSuite Advanced software interface. The top navigation bar includes 'StartCenter', 'Calibration', 'Table View', 'History', 'Statistics', and 'pH Buffers'. The 'pH Buffers' tab is selected and highlighted. The main display area is divided into three sections: 'Measured values', 'Sensor data', and 'Adjustment data'. The 'Measured values' section shows a pH value of 7.09 pH, pH voltage of 49.2 mV, and Temperature of 25.1 °C. The 'Sensor data' section lists: Sensor type: pH (glass), Manufacturer: KNICK, Order code: SE 533X/1-NMSN, Serial number: 1030550, Measuring point: 1030550, and Tag number: 0. The 'Adjustment data' section shows: Date: 6/27/2011 20:09:12, Slope: 58.5 mV/pH, and Zero point: 7.06 pH. A red circle highlights the '7.09 pH' value in the 'Measured values' section, and a red box highlights the 'pH Buffers' tab in the navigation bar. A red circle also highlights the '7.09 pH' value in a magnified view at the bottom of the page.

| Measured values | Sensor data | Adjustment data |
|--------------------------|----------------------------|--------------------------|
| pH value: 7.09 pH | Sensor type: pH (glass) | Date: 6/27/2011 20:09:12 |
| pH voltage: 49.2 mV | Manufacturer: KNICK | Slope: 58.5 mV/pH |
| Temperature: 25.1 °C | Order code: SE 533X/1-NMSN | Zero point: 7.06 pH |
| | Serial number: 1030550 | |
| | Measuring point: 1030550 | |
| | Tag number: 0 | |

Standard connection (sensor A)

| | | |
|---|---------------|------------|
| 1 | Brown | +3 V |
| 2 | Green | RS 485 A |
| 3 | Yellow | RS 485 B |
| 4 | White/Transp. | GND/shield |

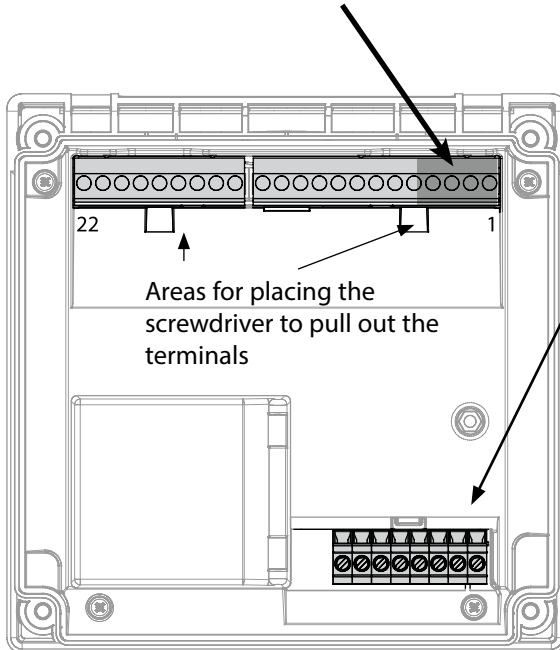

**For dual devices
(2 measuring
channels):
(MK-MS095 module)
Connection of sensor B**

| | | |
|---|---------|----------|
| A | Brown | +3 V |
| B | Green | RS 485 A |
| C | Yellow | RS 485 B |
| D | White | GND |
| E | Transp. | SHIELD |

Memosens Cable

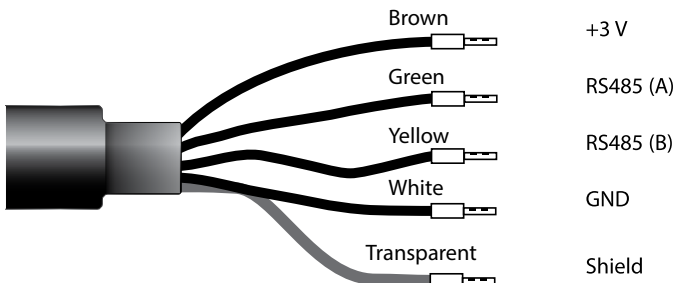

Connecting cable for non-contact inductive digital transmission of measured signals (Memosens).

By providing perfect galvanic isolation between sensor and analyzer/transmitter, the Memosens cable prevents measurement interferences. Any effects of humidity and corrosion are prevented.

Specifications

| | |
|---------------------|-------------------------------------|
| Material | TPE |
| Cable diameter | 6.3 mm |
| Length | up to 100 m |
| Process temperature | -20 °C ... +135 °C / -4 ... +275 °F |
| Ingress protection | IP 68 |

Order Codes

| | Cable type | Cable length | Order code |
|---------------------|-----------------|--------------|--------------|
| Memosens | Ferrules | 3 m | CA/MS-003NAA |
| | | 5 m | CA/MS-005NAA |
| | | 10 m | CA/MS-010NAA |
| | | 20 m | CA/MS-020NAA |
| | M12 plug, 8-pin | 3 m | CA/MS-003NCA |
| | | 5 m | CA/MS-005NCA |
| Memosens Ex* | Ferrules | 3 m | CA/MS-003XAA |
| | | 5 m | CA/MS-005XAA |
| | | 10 m | CA/MS-010XAA |
| | | 20 m | CA/MS-020XAA |
| | M12 plug, 8-pin | 3 m | CA/MS-003XCA |
| | | 5 m | CA/MS-005XCA |

Other cable lengths or cable types are available on request.

* Ex-certified ATEX II 1G Ex ia IIC T3/T4/T6 Ga

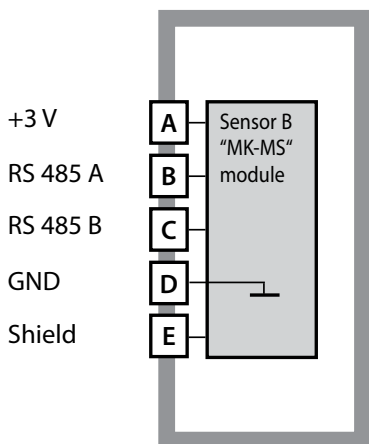

Module for 2nd Memosens channel

Order code MK-MS095...

See the following pages for wiring examples.

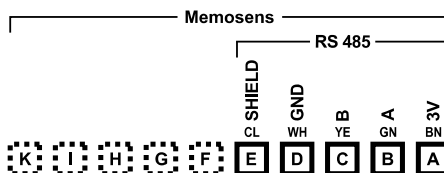

Terminal plate of module for 2nd Memosens channel

The terminals are suitable for single or stranded wires up to 2.5 mm² (AWG 14).

The measuring module comes with a self-adhesive label.

Stick the label to the module slot on the device front. This way, you have the wiring "under control".

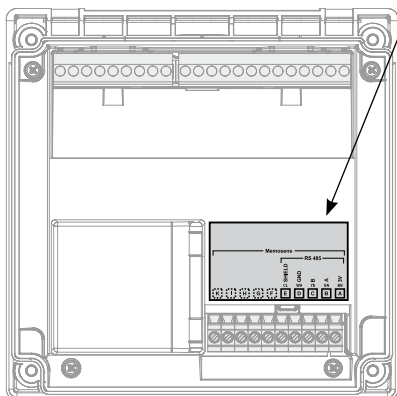

Example 1:

Measuring task: pH/ORP, temp, glass impedance, ref. impedance
Sensors (example): SE 554X/1-AMSN (Memosens combo sensor)
Cable (example): CA/MS-003NAA

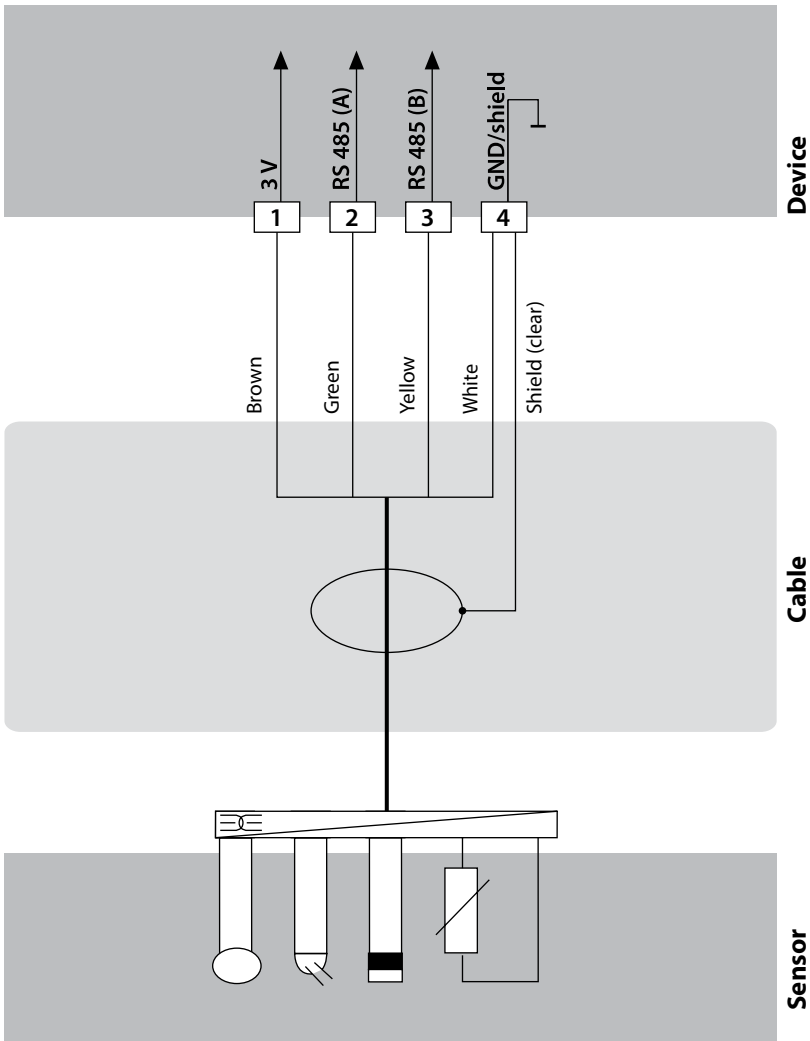

Example 2:

Measuring task: pH, temp, glass impedance

Sensors (example): SE 555X/1-NMSN

Cable (example): CA/MS-003NAA

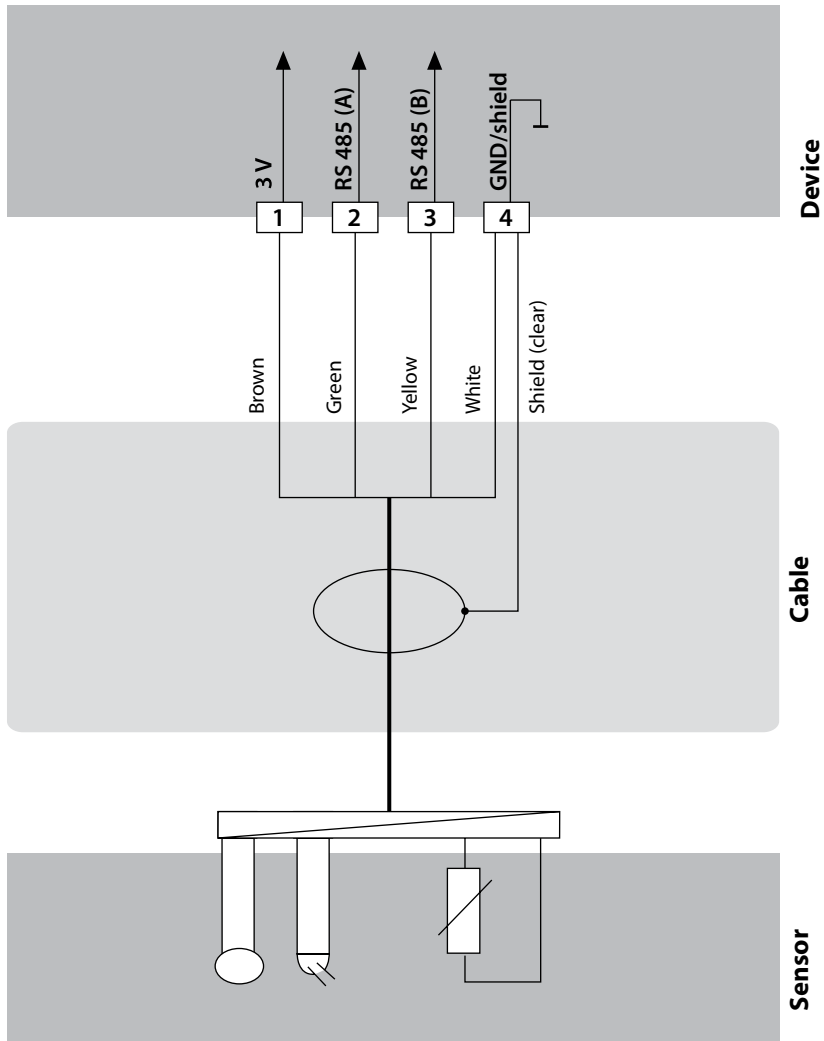

Measuring Mode

Prerequisite: A Memosens sensor is connected or a measuring module is installed with a corresponding analog sensor connected.

After the operating voltage has been connected, the analyzer automatically goes to "Measuring" mode. To call the measuring mode from another operating mode (e.g., Diagnostics, Service): Hold **meas** key depressed (> 2 s).

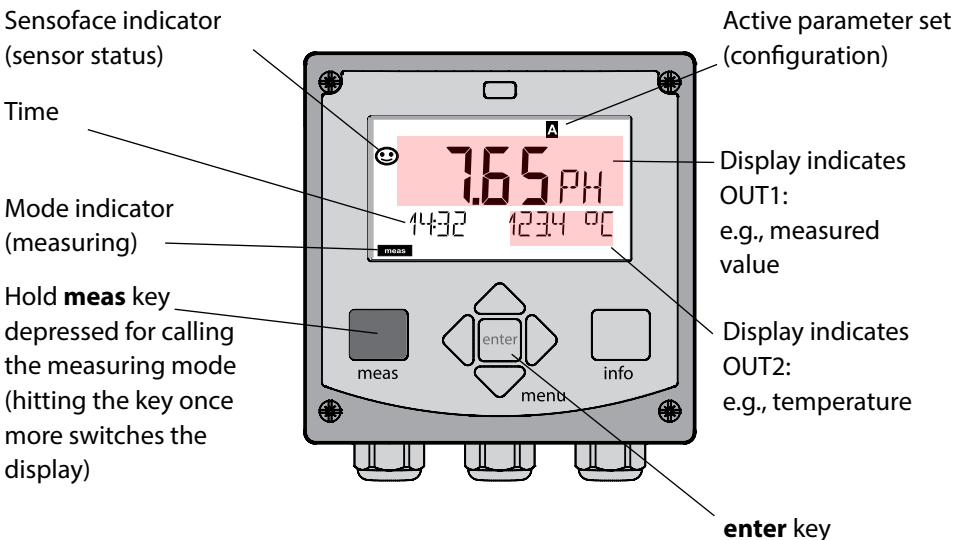

Depending on the configuration, you can set various displays as standard display for the measuring mode (see page 43).

Note: By pressing the **meas** key in measuring mode you can view the displays for approx. 60 sec.



NOTICE:

You must configure the analyzer for the respective measurement task.

Up / Down arrows

- Menu: Increase/decrease a numeral
- Menu: Selection

Left / Right arrows

- Menu: Previous/next menu group
- Number entry: Move between digits

meas

- Return to last menu level
- Directly to measuring mode (press > 2 s)
- Measuring mode: other display (temporarily for approx. 60 s)

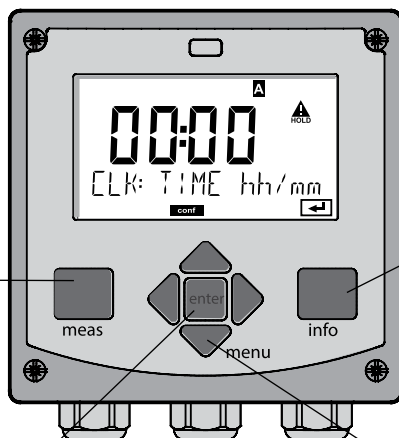

enter

- Configuration: Confirm entries, next configuration step
- Calibration: Continue program flow

info

- Retrieve information
- Show error messages

menu

- Measuring mode: Call menu

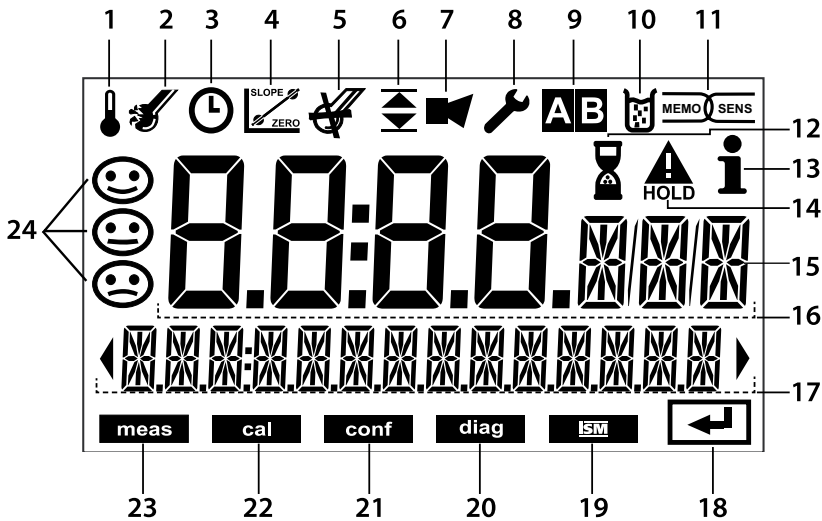

- | | | | |
|----|--|----|-----------------------|
| 1 | Temperature | 13 | Info available |
| 2 | Sensocheck | 14 | HOLD mode active |
| 3 | Interval/response time | 15 | Unit symbols |
| 4 | Sensor data | 16 | Primary process value |
| 5 | Sensocheck | 17 | Secondary display |
| 6 | Limit message: Limit 1 ▼ or Limit 2 ▲ | 18 | Proceed using enter |
| 7 | Alarm | 19 | ISM sensor |
| 8 | Service | 20 | Diagnostics |
| 9 | Parameter set | 21 | Configuration mode |
| 10 | Calibration | 22 | Calibration mode |
| 11 | Memosens sensor | 23 | Measuring mode |
| 12 | Waiting time running | 24 | Sensoface |

Signal Colors (Display Backlighting)

- | | |
|--------------|---|
| Red | Alarm (in case of fault: display values blink) |
| Red blinking | Input error: illegal value or wrong passcode |
| Orange | HOLD mode (Calibration, Configuration, Service) |
| Turquoise | Diagnostics |
| Green | Info |
| Magenta | Sensoface message (pre-alarm) |

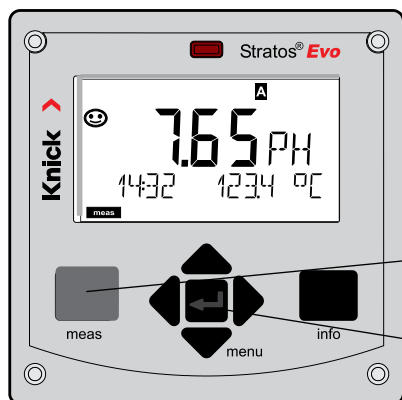

The MAIN DISPLAY is the display which is shown in measuring mode. To call the measuring mode from any other mode, hold the **meas** key depressed for at least 2 sec.

meas key

enter key



By pressing **meas** briefly you can step through further displays such as tag number (TAG) or flow (L/h).

These displays are turquoise. After 60 sec they switch back to the main display.

Press **enter** to select a display as MAIN DISPLAY.

The secondary display shows "MAIN DISPLAY – NO". Use the **UP / DOWN** arrows to select "MAIN DISPLAY – YES" and confirm by pressing **enter**.

The display color changes to white. This display is now shown in measuring mode.

The color-coded user interface guarantees increased operating safety.

Operating modes are clearly signaled.

The normal measuring mode is white. Information text appears on a green screen and the diagnostic menu appears on turquoise. The orange HOLD mode (e.g., during calibration) is quickly visible as is the magenta screen which indicates asset management messages for predictive diagnostics – such as maintenance request, pre-alarm and sensor wear.

The alarm status has a particularly noticeable red display color and is also signaled by flashing display values. Invalid inputs or false passcodes cause the entire display to blink red so that operating errors are significantly reduced.

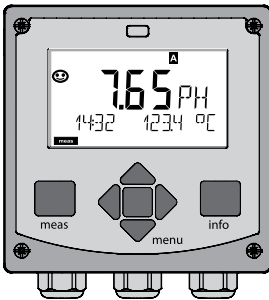

White:
Measuring mode

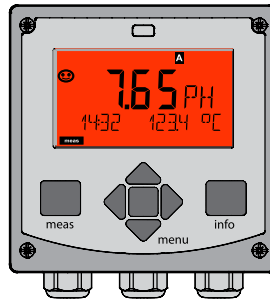

Red blinking:
Alarm, error

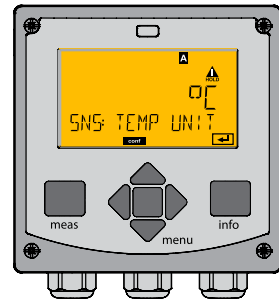

Orange:
HOLD mode

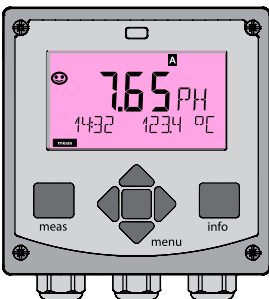

Magenta:
Maintenance request

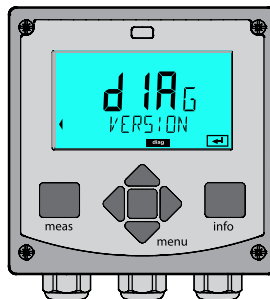

Turquoise:
Diagnostics

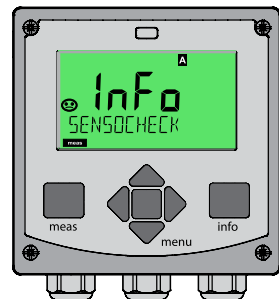

Green:
Info texts

To select the operating mode:

- 1) Hold **meas** key depressed (> 2 s) (measuring mode)
- 2) Press **menu** key: the selection menu appears
- 3) Select operating mode using left / right arrow key
- 4) Press **enter** to confirm the selected mode

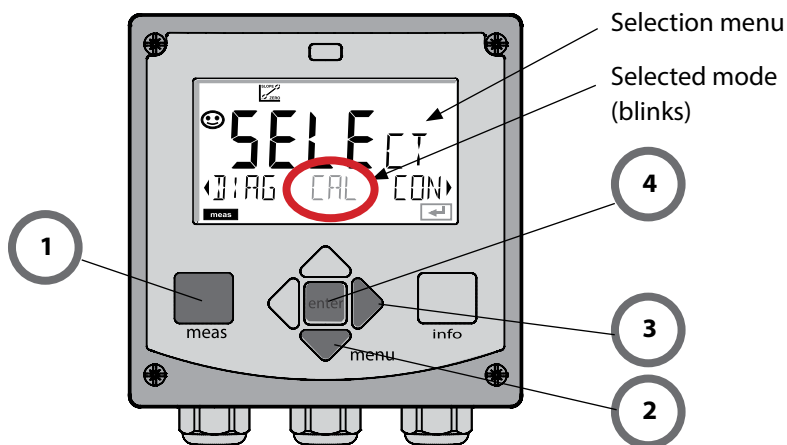

To enter a value:

- 5) Select numeral: left / right arrow
- 6) Change numeral: up / down arrow
- 7) Confirm entry by pressing **enter**

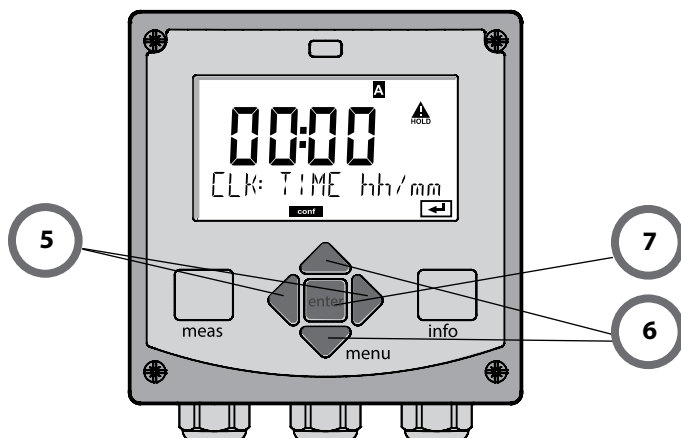

Diagnostics

Display of calibration data, display of sensor data, sensor monitor, performing a device self-test, viewing the logbook entries, display of hardware/software versions of the individual components. The logbook can store 100 events (00...99). They can be displayed directly on the device. The logbook can be extended to 200 entries using a TAN (Option).

HOLD

Manual activation of HOLD mode, e.g., for replacing a sensor. The signal outputs adopt a defined state.

Calibration

Every sensor has typical characteristic values, which change in the course of the operating time. Calibration is required to supply a correct measured value. The device checks which value the sensor delivers when measuring in a known solution. When there is a deviation, the device can be "adjusted". In that case, the device displays the "actual" value and internally corrects the measurement error of the sensor. Calibration must be repeated at regular intervals. The time between the calibration cycles depends on the load on the sensor. During calibration the device is in HOLD mode.

During calibration the device remains in the HOLD mode until it is stopped by the operator.

Configuration

You must configure the analyzer for the respective measurement task. In the "Configuration" mode you select the adjusted measuring function, the connected sensor, the measuring range to be transmitted, and the conditions for warning and alarm messages. During configuration the device is in HOLD mode.

Configuration mode is automatically exited 20 minutes after the last keystroke. The device returns to measuring mode.

Service

Maintenance functions (current source, relay test, controller test), passcode assignment, device type selection, reset to factory settings, enabling of options (TAN).

The HOLD mode is a safety state during configuration and calibration. Output current is frozen (LAST) or set to a fixed value (FIX). Alarm and limit contacts are disabled.

The display backlighting turns orange, display icon:



Output signal response

- **LAST:** The output current is frozen at its last value. Recommended for short configuration procedures. The process should not change decisively during configuration. Changes are not noticed with this setting!
- **Fix:** The output current is set to a value that is noticeably different from the process value to signal the control system that the device is being worked at.

Output signal during HOLD:

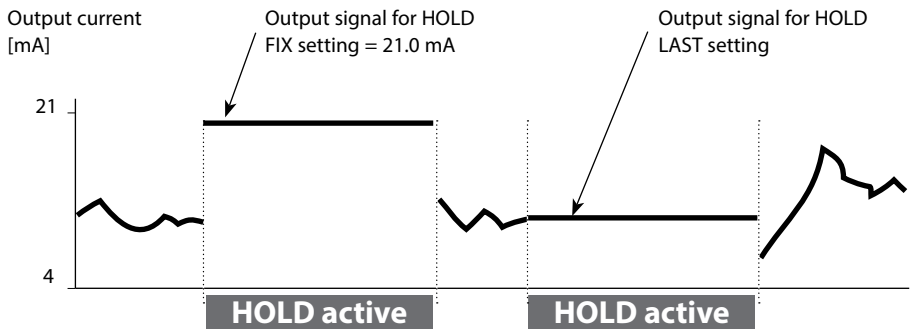

Terminating the HOLD mode

The HOLD mode is exited by switching to measuring mode (hold **meas** key depressed). The display reads "Good Bye". After that, the HOLD mode is exited. When the calibration mode is exited, a confirmation prompt ensures that the installation is ready for operation (e.g.: sensor reinstalled, located in process).

External activation of HOLD

The HOLD mode can be activated from outside by sending a signal to the HOLD input (e.g., from the process control system).

| | |
|---------------|-----------------|
| HOLD inactive | 0...2 V AC/DC |
| HOLD active | 10...30 V AC/DC |

Alarm

When an error has occurred, **Err xx** is displayed immediately.

Only after expiry of a user-defined delay time will the alarm be registered and entered in the logbook.

During an alarm the display blinks, the display backlighting turns **red**.

Error messages can also be signaled by a 22 mA output current (when configured correspondingly).

The alarm contact is activated by alarm or power failure. 2 sec after the failure event is corrected, the alarm status will be deleted.

The 22-mA signal can also be triggered by Sensoface messages (configurable).

Generating a message via the CONTROL input

(min. flow / max. flow)

The CONTROL input can be used for parameter set selection or for flow measurement (pulse principle), depending on its assignment in the "Configuration" menu.

First, the flow transmitter must be calibrated in the CONTROL menu: ADJUST FLOW

When preset to flow measurement

CONF/CNTR_IN/CONTROL = FLOW

an alarm can be generated when the measured flow exceeds a specified range:

CONF/ALA/FLOW CNTR = ON

CONF/ALA/FLOW min (specify value, default: 5 liters/h)

CONF/ALA/FLOW max (specify value, default: 25 liters/h)

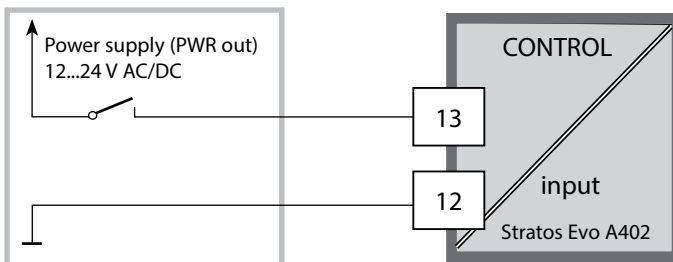

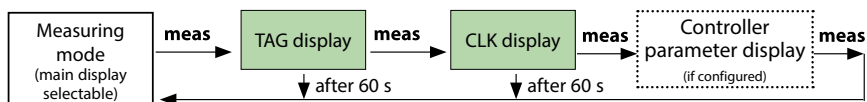

Pressing the **menu** key (down arrow) opens the selection menu.
 Select the menu group using the left/right arrow keys.
 Pressing **enter** opens a menu item. Press **meas** to return.



| | | |
|--|---|--|
| DIAG | CALDATA | Display of calibration data |
| | SENSOR | Display of sensor data |
| | SELFTEST | Self test: RAM, ROM, EEPROM, module |
| | LOGBOOK | 100 events with date and time |
| | MONITOR | Display of direct sensor values |
| | VERSION | Display of software version, model designation, serial no. |
| HOLD | Manual activation of HOLD mode, e.g., for sensor replacement. The signal outputs behave as configured (e.g., last measured value, 21 mA) | |
| CAL | pH | pH adjustment / ORP adjustment / product calibration |
| | Oxy | Adjustment (WTR/AIR) / zero adjustment / prod. cal. |
| | COND(I) | Adjustment with solution / cell factor input / prod. cal. |
| | CAL_RTDT | Adjustment of temperature probe |
| CONF | PARSET A | For configuring parameter set A / B see "Overview of Configuration" on next page. |
| | PARSET B | |
| SERVICE (Access via code, factory setting: 5555) | MONITOR | Display of measured values for validation (simulators) |
| | SENSOR | Sensor (resetting diagnostics messages) |
| | POWER OUT | Selecting the output voltage (3.1 V / 12 V / 15 V / 24 V) |
| | OUT1 | Current source, output 1 |
| | OUT2 | Current source, output 2 |
| | RELAIS | Relay test |
| | CONTROL | Controller: manual specification of controller output |
| | CODES | Specifying access codes for operating modes |
| | DEVICE TYPE | Selecting the device type |
| | DEFAULT | Reset to factory setting |
| | OPTION | Enabling an option via TAN |

The configuration steps are assigned to different menu groups. Using the left/right arrow keys, you can jump between the individual menu groups. Each menu group contains menu items for setting the parameters. Pressing **enter** opens a menu item. Use the arrow keys to edit a value. Press **enter** to confirm/save the settings. Return to measurement: Hold **meas** key depressed (> 2 s).

| Select menu group | Menu group | Code | Display | Select menu item |
|-------------------|---|---------------------|--------------------------|------------------|
| | Sensor selection (multi-channel device: select sensor A / sensor B) | SNS: (S_A / S_B) | Conf SENSOR | |
| | | Menu item 1 | | |
| | | : | | |
| | | Menu item ... | | |
| ▶ | Current output 1 | OT1: | Conf OUT 1 | |
| ▶ | Current output 2 | OT2: | Conf OUT 2 | |
| ▶ | Compensation | COR: | Conf CORRECTION | |
| ▶ | Control input (parameter set or flow measurement) | IN: | 0000 COR: TC L: BU: 1 | |
| ▶ | Alarm mode | ALA: | Conf ALARM | |
| ▶ | Relay outputs | REL: | Conf REL 1/REL 2 | |
| ▶ | Cleaning | WSH: | Conf WASH | |
| ▶ | Setting the clock | CLK: | Conf CLOCK | |
| ▶ | Tag number | TAG: | Conf TAG | |

Note: With MSPH-MSPH or MSPH-MSOXY dual devices, the two parameter sets are replaced by the two sensors A and B.

Parameter Set A/B: Configurable Menu Groups

The device provides 2 parameter sets "A" and "B". By switching between the parameter sets you can adapt the device to different measurement situations, for example. Parameter set "B" only permits setting of process-related parameters.

| Menu group | Parameter set A | Parameter set B |
|-------------|---|------------------|
| SENSOR | Sensor selection | --- |
| OUT1 | Current output 1 | Current output 1 |
| OUT2 | Current output 2 | Current output 2 |
| CORRECTION | Compensation | Compensation |
| CNTR_IN | Control input | --- |
| ALARM | Alarm mode | Alarm mode |
| REL 1/REL 2 | Relay outputs | Relay outputs |
| WASH | Cleaning | --- |
| PARSET | Parameter set selection (not for dual devices) | --- |
| CLOCK | Setting the clock | --- |
| TAG | TAG of measuring point | --- |
| GROUP | GROUP of measuring points | --- |

External switchover of parameter sets A/B

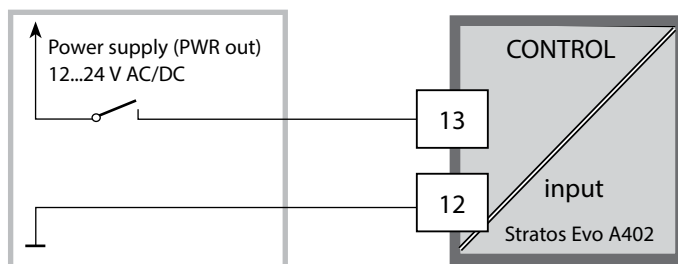

You can switch between parameter sets A and B by applying a signal to the CONTROL input (setting: CNTR-IN – PARSET).



Parameter set A active 0...2 V AC/DC

Parameter set B active 10...30 V AC/DC

Parameter Set A/B: Manual Switchover

| Display | Action | Remark |
|--|--|--|
| | To switch between parameter sets: Press meas | Manual selection of parameter sets must have been preset in CONFIG mode. Default setting is a fixed parameter set A. Wrong settings change the measurement properties! |
|  | PARSET blinks in the lower line. Select parameter set using ◀ and ▶ keys. | |
|  | Select PARSET A / PARSET B | The currently active parameter set is read on the display:  |
| | Press enter to confirm. Cancel by pressing meas | |

Parameter Set A/B: Signaling via WASH Contact

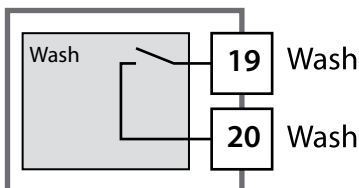





The active parameter set can be signaled using the WASH contact:

If configured correspondingly, the WASH contact signals:

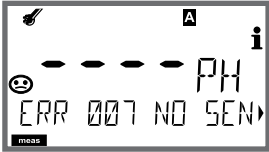
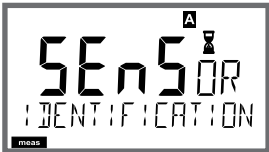
Parameter set A: Contact open

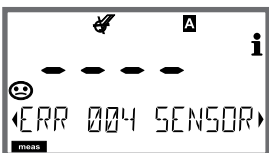
Parameter set B: Contact closed

| Step | Action/Display | Remark |
|---|--|--|
| Connect sensor |  | Before a Memosens sensor is connected, the error message "NO SENSOR" is displayed. |
| Wait until the sensor data are displayed. |  | The hourglass in the display blinks. |
| Check sensor data |  <p>View sensor information using ◀ ▶ keys, confirm using enter.</p> | Sensoface is friendly when the sensor data are okay. |
| Go to measuring mode | Press meas , info or enter | After 60 sec the device automatically returns to measuring mode (timeout). |
| Possible error message | | |
| Sensor defective. Replace sensor |  | When this error message appears, the sensor cannot be used. Sensoface is sad. |

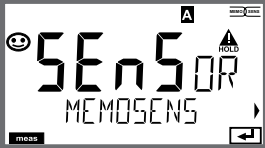
| Step | Action/Display | Remark |
|---|---|--|
| Select HOLD mode A sensor should only be replaced during HOLD mode to prevent unintended reactions of the outputs or contacts. | Press menu key to call the selection menu, select HOLD using the ◀ ▶ keys, press enter to confirm. | Now the device is in HOLD mode. The HOLD mode can also be activated externally via the HOLD input. During HOLD the output current is frozen at its last value or set to a fixed value. |
| Disconnect and remove old sensor | | |
| Install and connect new sensor. | | Temporary messages which are activated during the replacement are indicated but not output to the alarm contact and not entered in the logbook. |
| Wait until the sensor data are displayed. |  | |
| Check sensor data |  <p>View sensor information using ◀ ▶ keys, confirm using enter.</p> | You can view the sensor manufacturer and type, serial number and last calibration date. |
| Check measured values | | |
| Exit HOLD | Hit meas key: Return to the selection menu. Hold meas key depressed: Device switches to measuring mode. | |

Overview of pH Sensor Configuration

| pH sensor | | Choices | Default |
|--|---|--|------------------------|
| SNS: | | STANDARD, ISFET INDUCON, ISM MEMOSENS | STANDARD |
| RTD TYPE (omitted for MEMOSENS and ISM) | | 100 PT, 1000 PT, 30 NTC, 8.55 NTC, Balco 3kOhm | 100 PT |
| TEMP UNIT | | °C / °F | °C |
| TEMP MEAS *) | | AUTO, MAN, EXT (EXT only with I-input enabled via TAN) | AUTO |
| | MAN | -20...200 °C (-4...392 °F) | 025.0 °C (077.0 °F) |
| TEMP CAL | | AUTO, MAN, EXT | AUTO |
| | MAN | -20...200 °C (-4...392 °F) | 025.0 °C (077.0 °F) |
| NOM ZERO **) | | 0.00 ... 14.00 PH | 07.00 PH |
| NOM SLOPE **) | | 30.0 ... 60.0 mV | 059.2 mV |
| PH_ISO **) | | 0.00 ... 14.00 PH | 07.00 PH |
| CAL MODE | | AUTO, MAN, DAT | AUTO |
| | AUTO BUFFER SET | -01-...-10-, -U1- Note: Pressing info displays nominal buffer values + manufacturer | -02- |
| | U1 (For specifiable buffer set, see Appendix: "Buffer Tables") | EDIT BUFFER 1 (NO, YES) Enter values for buffer 1 | NO |
| | | EDIT BUFFER 2 (NO, YES) Enter values for buffer 2 | NO |
| CAL TIMER (omitted for ISM) | | OFF, FIX, ADAPT | OFF |
| ON | CAL-CYCLE | 0...9999 h | 0168 h |

* The setting: TEMP MEAS: AUTO/MAN/EXT applies to all outputs: OUT1/OUT2/limit values/controller/display; Sensors with deviating zero/slope require the "Pfaudler" option (TAN).

Settings with "Sensor: STANDARD" selected (not required for Memosens Pfaudler sensor).

** only with STANDARD and Pfaudler option (TAN), not with Memosens Pfaudler.

Overview of pH Sensor Configuration

| pH sensor | | Choices | Default |
|-----------|------------------------|--|-------------------|
| SNS: | ACT (ISM only) | OFF, AUTO, MAN | OFF |
| | | ACT CYCLES | 0000 ... 2000 DAY |
| | TTM (ISM only) | OFF, AUTO, MAN | OFF |
| | | TTM CYCLES | 0000 ... 2000 DAY |
| | CIP COUNT | ON, OFF | OFF |
| | | CIP CYCLES (Memosens and ISM) | 0000 ... 9999 CYC |
| | SIP COUNT | ON, OFF | OFF |
| | | SIP CYCLES (Memosens and ISM) | 0000 ... 9999 CYC |
| | AUTOCLAVE | ON, OFF | OFF |
| | | AUTOCLAVE CYCLES (Memosens and ISM) | 0000 ... 9999 CYC |
| | CHECK TAG (Memosens) | ON, OFF | OFF |
| | CHECK GROUP (Memosens) | ON, OFF | OFF |

Sensor Verification (TAG, GROUP)

When Memosens sensors are calibrated in the lab, it is often useful and sometimes even mandatory that these sensors will be operated again at the same measuring points or at a defined group of measuring points. To ensure this, you can save the respective measuring point (TAG) or group of measuring points (GROUP) in the sensor. TAG and GROUP can be specified by the calibration tool or automatically entered by the transmitter. When connecting an MS sensor to the transmitter, it can be checked if the sensor contains the correct TAG or belongs to the correct GROUP. If not, a message will be generated, Sensoface gets "sad", and the display backlighting turns magenta (purple). The "sad" Sensoface icon can also be signaled by a 22 mA error current. Sensor verification can be switched on in the Configuration in two steps as TAG and GROUP if required.

When no measuring point or group of measuring points is saved in the sensor, e.g., when using a new sensor, Stratos enters its own TAG and GROUP. When sensor verification is switched off, Stratos always enters its own measuring point and group. A possibly existing TAG/GROUP will be overwritten.

Support of Pfaudler Sensors

or pH sensors with a zero point other than pH 7 and/or deviating slope, e.g., pH sensors with a zero point at pH 4.6

This requires an additional function (TAN).

The option is enabled in the SERVICE / OPT: PFAUDLER menu.

For Pfaudler standard pH sensors, you can specify a nominal zero point and a nominal slope. In addition, you can enter a pHiso value.

The additional entries appear in the CONFIGURATION / SENSOR menu:

SNS: NOM ZERO (default: 07.00 pH)

SNS: NOM SLOPE (default: 59.2 mV)

SNS: PH_ISO (default: 07.00 pH)

Prior to measurement, you must enter the values for nominal zero and slope and the isothermal intersection point pHiso as provided by the manufacturer and perform a calibration using suitable buffer solutions.

When you use a Memosens Pfaudler sensor, the data will be read from the sensor or will be set to standard values. Here, you do not have to make entries. The respective menu items will be suppressed.

The nominal ZERO/SLOPE values are required for the proper functioning of the sensor monitoring and calibration functions (Sensoface, Calimatic), they do not replace an adjustment (calibration)!

Typical values

| Probe | Pfaudler enamel probes (Pfaudler specifications) | Probes with absolute pH measurement and Ag/AgCl reference system | Probes with absolute pH measurement and Ag/A (silver acetate) reference system | Differential pH probe |
|------------|--|--|--|-----------------------|
| Nom. slope | 55 mV/pH | 55 mV/pH | 55 mV/pH | 55 mV/pH |
| Nom. zero | pH 8.65 | pH 8.65 | pH 1.35 | pH 7 ... 12 |
| pHiso | pH 1.35 | pH 1.35 | pH 1.35 | pH 3.00 |

Note:

Please refer to the operating instructions of the respective sensor for more information on functioning, installation, calibration and configuration.

Device Type: pH

Connected modules are automatically recognized. When no module is installed, but a Memosens sensor is connected at initial start-up, it is recognized and the corresponding process variable is automatically selected. In the SERVICE menu you can change the device type. Afterwards, you must select the corresponding calibration mode in the CONF menu.

- 1 Press **menu**.
- 2 Select **CONF** using ◀ ▶, press **enter**.
- 3 Select parameter set using ◀ ▶ keys, press **enter**.
- 4 Select **SENSOR** menu using ◀ ▶ keys, press **enter**.
- 5 All items of this menu group are indicated by the "SNS:" code. Press **enter** to select menu, edit using arrow keys (see next page). Confirm (and proceed) by pressing **enter**.
- 6 Exit: Press **meas** key until the [meas] mode indicator is displayed.

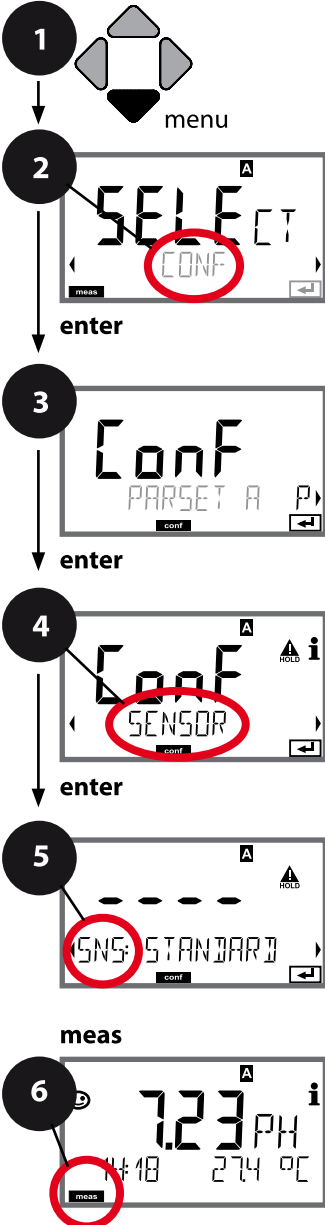

5

| | |
|-----------------------------------|--------------|
| Select sensor type | enter |
| Select type of temp probe | enter |
| Temperature unit | enter |
| Temp detection during measurement | |
| (Manual temperature) | |
| Temp detection during calibration | |
| (Manual temperature) | |
| Calibration mode | |
| Calibration timer | |
| Calibration cycle | |
| CIP/SIP cycles | |
| Autoclaving counter | |
| CHECK TAG | |
| CHECK GROUP | |

5

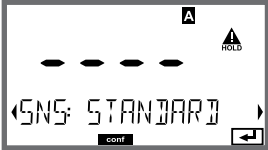
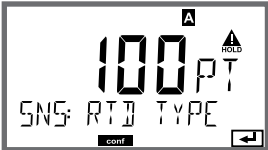
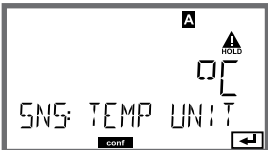
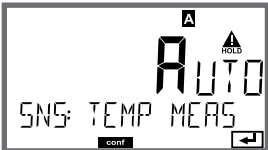
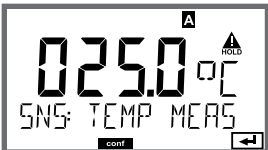

| Menu item | Action | Choices |
|--|---|--|
| Select sensor type  | Select sensor type using ▲ ▼ keys. Press enter to confirm. | STANDARD ISFET Digital sensors: INDUCON ISM MEMOSENS |
| Select type of temp probe  | (not for digital sensors) Select type of temperature probe using ▲ ▼ keys. Press enter to confirm. | 100 PT 1000 PT 30 NTC 8.55 NTC Balco 3 kOhm |
| Temperature unit  | Select °C or °F using ▲ ▼ keys. Press enter to confirm. | °C / °F |
| Temp detection during measurement  | Select mode using ▲ ▼ keys: AUTO: Measured by sensor MAN: direct input of temperature, no measurement (see next step) EXT: Temperature specified via current input (only if enabled via TAN) Press enter to confirm. | AUTO MAN EXT |
| (Manual temperature)  | Modify digit using ▲ ▼ keys, select next digit using ◀ ▶ keys. Press enter to confirm. | -20...200 °C (-4...+392 °F) |

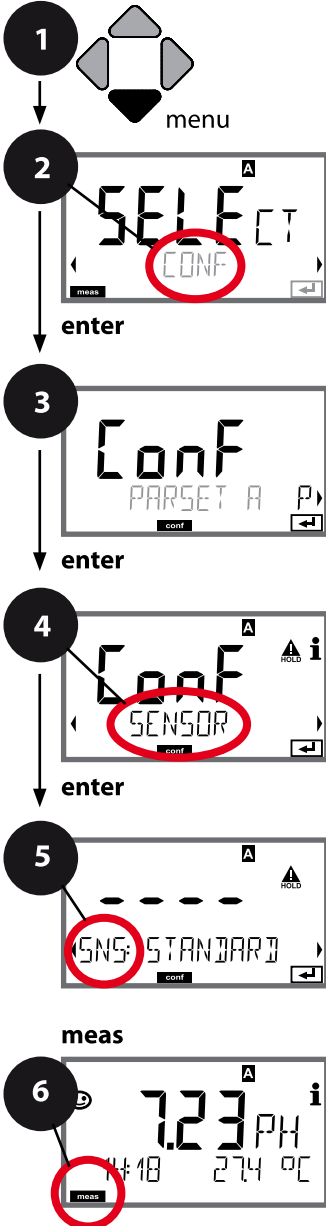
SENSOR, Temp Detection during Calibration, Calibration Mode

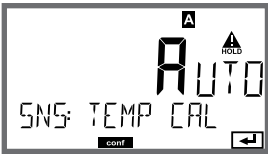
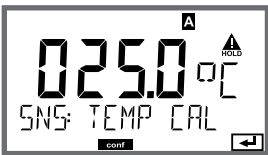

- 1 Press **menu** key.
- 2 Select **CONF** using ◀ ▶, press **enter**.
- 3 Select parameter set using ◀ ▶ keys, press **enter**.
- 4 Select **SENSOR** menu using ◀ ▶ keys, press **enter**.
- 5 All items of this menu group are indicated by the "SNS:" code. Press **enter** to select menu, edit using arrow keys (see next page). Confirm (and proceed) by pressing **enter**.
- 6 Exit: Press **meas** key until the [meas] mode indicator is displayed.

| | | |
|-----------------------------------|---|-------|
| Select sensor type | 5 | enter |
| Select type of temp probe | | enter |
| Temperature unit | | enter |
| Temp detection during measurement | | |
| (Manual temperature) | | |
| Temp detection during calibration | | |
| (Manual temperature) | | |
| Calibration mode | | |
| (AUTO: Buffer set) | | |
| Calibration timer | | |
| Calibration cycle | | |
| CIP/SIP cycles | | |
| Autoclaving counter | | |
| CHECK TAG | | |
| CHECK GROUP | | |

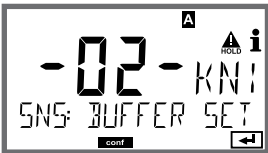
| Menu item | Action | Choices |
|--|--|--|
| <p>Temp detection during calibration</p>  | <p>Select mode using ▲ ▼ keys: AUTO: Measured by sensor MAN: direct input of temperature, no measurement (see next step) EXT: Temperature specified via current input (only if enabled via TAN) Press enter to confirm.</p> | <p>AUTO MAN EXT</p> |
| <p>(Manual temperature)</p>  | <p>Modify digit using ▲ ▼ keys, select next digit using ◀ ▶ keys. Press enter to confirm.</p> | <p>-20...200 °C (-4...+392 °F)</p> |
| <p>Calibration mode</p>  | <p>Select CALMODE using ▲ ▼ keys: AUTO: Calibration with Calimatic buffer set recognition MAN: Manual entry of buffer solutions DAT: Input of adjustment data of premeasured sensors Press enter to confirm.</p> | <p>AUTO MAN DAT</p> |
| <p>(AUTO: Buffer set)</p>  | <p>Select buffer set using ▲ ▼ keys (see buffer tables for nominal values) Press enter to confirm.</p> | <p>-01-...-10-, -U1- (see Appendix)</p> <p>Pressing the info key displays the manufacturer and nominal values in the lower line.</p> |

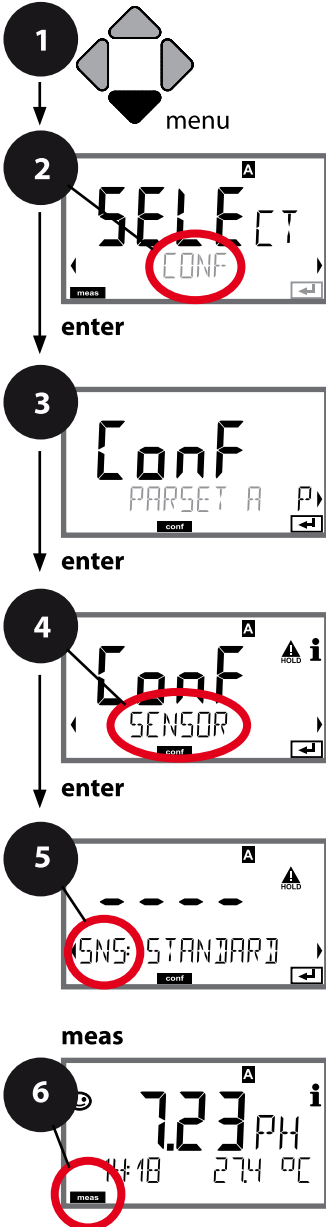

Sensor, Calibration Timer, Calibration Cycle



- 1 Press **menu** key.
- 2 Select **CONF** using ◀ ▶, press **enter**.
- 3 Select parameter set using ◀ ▶ keys, press **enter**.
- 4 Select **SENSOR** menu using ◀ ▶ keys, press **enter**.
- 5 All items of this menu group are indicated by the "SNS:" code. Press **enter** to select menu, edit using arrow keys (see next page). Confirm (and proceed) by pressing **enter**.
- 6 Exit: Press **meas** key until the [meas] mode indicator is displayed.



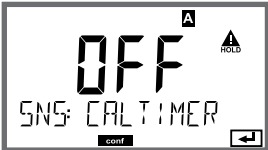

| | | |
|-----------------------------------|---|-------|
| Select sensor type | 5 | enter |
| Select type of temp probe | | enter |
| Temperature unit | | enter |
| Temp detection during measurement | | |
| (Manual temperature) | | |
| Temp detection during calibration | | |
| (Manual temperature) | | |
| Calibration mode | | |
| (AUTO: Buffer set) | | |
| Calibration timer | | |
| Calibration cycle | | |
| CIP/SIP cycles | | |
| Autoclaving counter | | |
| CHECK TAG | | |
| CHECK GROUP | | |

5

| Menu item | Action | Choices |
|--|--|---|
| Calibration timer  | Adjust CALTIMER using ▲ ▼ : OFF: No timer ADAPT: Maximum cal cycle (adjust in the next step) FIX: Fixed cal cycle (adjust in the next step) Press enter to confirm. | OFF/ADAPT/FIX With ADAPT, the calibration cycle is automatically reduced depending on the sensor load (high temperatures and pH values) and for digital sensors also depending on the sensor wear |
| Calibration cycle  | Only with FIX/ADAPT: Modify digit using ▲ ▼ keys, select next digit using ◀ ▶ keys. Press enter to confirm. | 0...9999 h |

Note for the calibration timer:

When Sensocheck has been activated in the Configuration / Alarm menu, the expiration of the calibration interval is indicated by Sensoface:

| Display | Status |
|---|---|
|  +  | Over 80 % of the calibration interval has already passed. |
|  +  | The calibration interval has been exceeded. |

The calibration timer settings apply to both parameter sets A and B.

The time remaining until the next due calibration can be seen in the diagnostics menu (see Diagnostics chapter).

ISM Sensor, Adaptive Cal Timer (ACT)

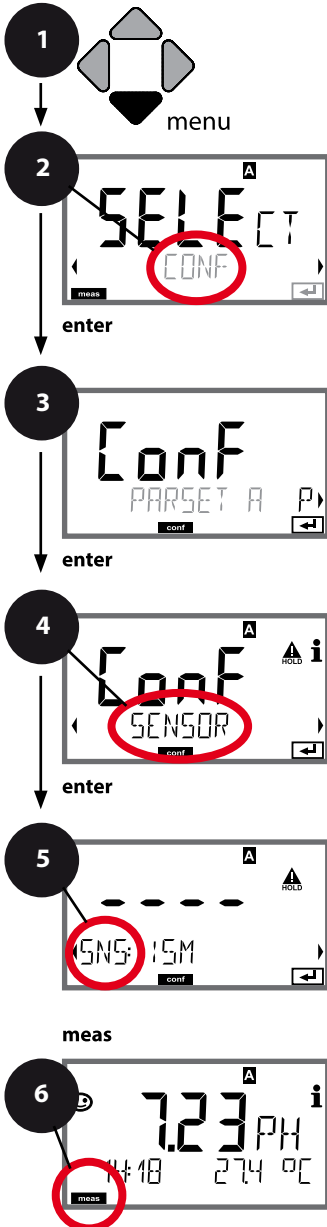

- 1 Press **menu** key.
- 2 Select **CONF** using ◀ ▶, press **enter**.
- 3 Select parameter set using ◀ ▶ keys, press **enter**.
- 4 Select **SENSOR** menu using ◀ ▶ keys, press **enter**.
- 5 All items of this menu group are indicated by the "SNS:" code. Press **enter** to select menu, edit using arrow keys (see next page). Confirm (and proceed) by pressing **enter**.
- 6 Exit: Press **meas** key until the [meas] mode indicator is displayed.

| | | |
|-----------------------------------|---|-------|
| Select sensor type | 5 | enter |
| Temperature unit | | enter |
| Temp detection during measurement | | enter |
| (Manual temperature) | | |
| Temp detection during calibration | | |
| (Manual temperature) | | |
| Calibration mode | | |
| (AUTO: Buffer set) | | |
| ACT - Adaptive calibration timer | | |
| TTM - Adaptive maintenance timer | | |
| CIP/SIP cycles | | |
| Autoclaving counter | | |

Adaptive Cal Timer (ACT)

By issuing a Sensoface message, the adaptive calibration timer reminds you to calibrate the sensor. After expiration of the interval, Sensoface is getting “sad”. Pressing the info key shows the text “OUT OF CAL TIME CALIBRATE SENSOR” which reminds you that a calibration is due. The ACT interval is either read automatically from the sensor settings or can be specified manually (max. 9999 days). Stressing influences (temperature, measurement in extreme ranges) shorten the timer interval.

The adaptive cal timer is reset after each calibration.

You can configure the current outputs so that a Sensoface message generates a 22-mA error signal, see page 91.

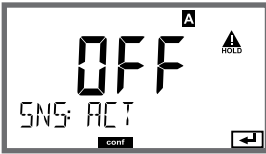
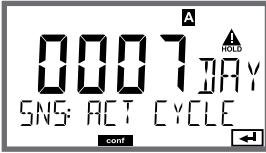
| Menu item | Action | Choices |
|--|--|---------------------|
| Adaptive cal timer (ACT)   | Select using ▲ ▼ : AUTO: The interval stored in the ISM sensor is used (default) MAN: The interval is specified manually (0 ... 9999 days) Confirm by pressing enter | OFF/AUTO/MAN |

ISM Sensor, Adaptive Maintenance Timer (TTM)

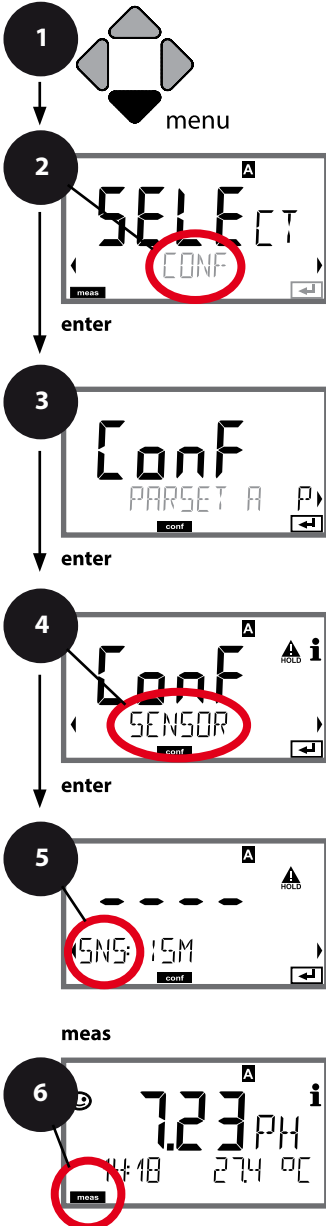

- 1 Press **menu** key.
- 2 Select **CONF** using ◀ ▶, press **enter**.
- 3 Select parameter set using ◀ ▶ keys, press **enter**.
- 4 Select **SENSOR** menu using ◀ ▶ keys, press **enter**.
- 5 All items of this menu group are indicated by the "SNS:" code.
Press **enter** to select menu, edit using arrow keys (see next page). Confirm (and proceed) by pressing **enter**.
- 6 Exit: Press **meas** key until the [meas] mode indicator is displayed.



| | | |
|---|---|-------|
| Select sensor type | 5 | enter |
| Temperature unit | | enter |
| Temp detection during measurement (Manual temperature) | | enter |
| Temp detection during calibration (Manual temperature) | | enter |
| Calibration mode (AUTO: Buffer set) | | |
| ACT - Adaptive calibration timer | | |
| TTM - Adaptive maintenance timer | | |
| CIP/SIP cycles | | |
| Autoclaving counter | | |

Adaptive Maintenance Timer (TTM, Time to Maintenance)

By issuing a Sensoface message, the adaptive maintenance timer reminds you to service the sensor. After expiration of the interval, Sensoface is getting “sad”. Pressing the info key shows the text “OUT OF MAINTENANCE CLEAN SENSOR” which reminds you that a sensor maintenance is due. The TTM interval is either read automatically from the sensor settings or can be specified manually (max. 9999 days).

Stressing influences (temperature, measurement in extreme ranges) shorten the timer interval.

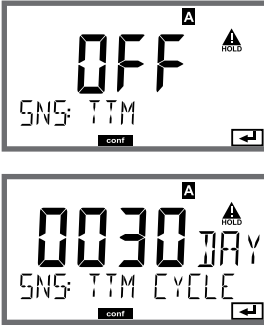
You can configure the current outputs so that a Sensoface message generates a 22-mA error signal, see page 91.

| Menu item | Action | Choices |
|--|---|----------------------------|
| <p>Adaptive maintenance timer (TTM)</p>  | <p>Select using ▲ ▼ keys: AUTO: The interval stored in the ISM sensor is used (default) MAN: The interval is specified manually (0 ... 9999 days)</p> <p>Confirm by pressing enter</p> | <p>OFF/AUTO/MAN</p> |
| <p>The adaptive maintenance timer can be reset in the SERVICE / SENSOR / TTM menu. Here, the interval is reset to its initial value.</p> | | |
|  | <p>To do so, select “TTM RESET = YES” and confirm by pressing enter.</p> | <p>NO / YES</p> |

Sensor, CIP Cleaning Cycles, SIP Sterilization Cycles

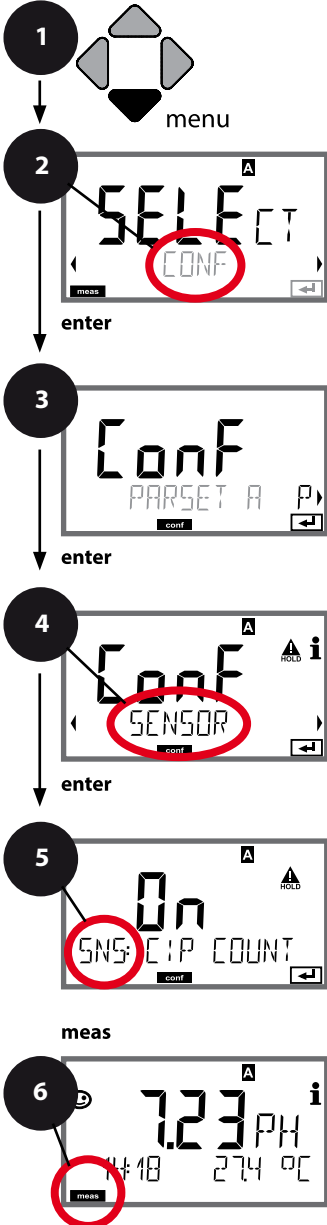

- 1 Press **menu** key.
- 2 Select **CONF** using ◀ ▶ , press **enter**.
- 3 Select parameter set using ◀ ▶ keys, press **enter**.
- 4 Select **SENSOR** menu using ◀ ▶ keys, press **enter**.
- 5 All items of this menu group are indicated by the "SNS:" code.
Press **enter** to select menu, edit using arrow keys (see next page). Confirm (and proceed) by pressing **enter**.
- 6 Exit: Press **meas** key until the [meas] mode indicator is displayed.

| | | |
|---|-----------------------------------|-------|
| 5 | Select sensor type | enter |
| | Temperature unit | ↻ |
| | Temp detection during measurement | ↻ |
| | (Manual temperature) | |
| | Temp detection during calibration | |
| | (Manual temperature) | |
| | Calibration mode | |
| | (AUTO: Buffer set) | |
| | ACT - Adaptive calibration timer | |
| | TTM - Adaptive maintenance timer | |
| | Cleaning cycle counter | |
| | Cleaning cycles | |
| | Sterilization cycle counter | |
| | Sterilization cycles | |
| | Autoclaving counter | |
| | CHECK TAG | |
| | CHECK GROUP | |

5

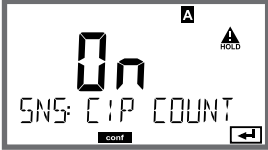
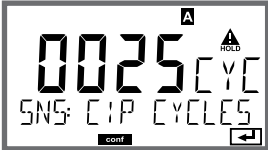
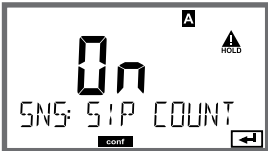
| Menu item | Action | Choices |
|--|---|--|
| <p>CIP counter</p>  | <p>Adjust CIP counter using ▲ ▼ : OFF: No counter ON: Fixed cleaning cycle (adjust in the next step) Press enter to confirm.</p> | <p>OFF/ON</p> |
| <p>CIP cycles</p>  | <p>Only with CIP COUNT ON: Enter max. number of cleaning cycles using ▲ ▼ ◀ ▶ keys Press enter to confirm.</p> | <p>0...9999 CYC (0000 CYC)</p> |
| <p>SIP counter</p>  | <p>Adjust SIP counter using ▲ ▼ : OFF: No counter ON: Max. sterilization cycles (adjust as for CIP counter) Press enter to confirm.</p> | <p>OFF/ON</p> |

The cleaning and sterilization cycles are counted to measure the load on the sensor. Suitable for biochemical applications (process temperature approx. 0 ... +50 °C / +32 ... +122 °F, CIP temperature > +55 °C / +131 °F, SIP temperature > +115 °C / +239 °F).

ISM Sensor, Autoclaving Counter

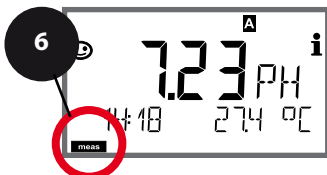
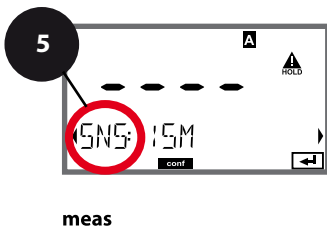
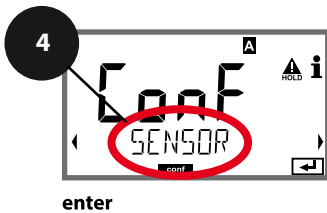
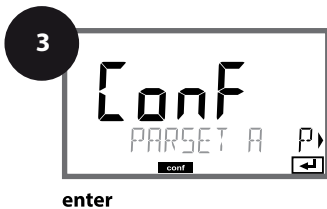
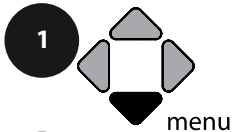

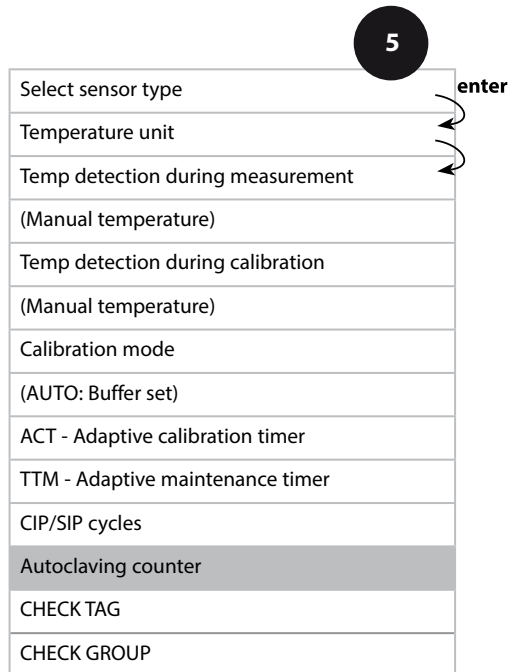

- 1 Press **menu** key.
- 2 Select **CONF** using ◀ ▶, press **enter**.
- 3 Select parameter set using ◀ ▶ keys, press **enter**.
- 4 Select **SENSOR** menu using ◀ ▶ keys, press **enter**.
- 5 All items of this menu group are indicated by the "SNS:" code. Press **enter** to select menu, edit using arrow keys (see next page). Confirm (and proceed) by pressing **enter**.
- 6 Exit: Press **meas** key until the [meas] mode indicator is displayed.



Autoclaving Counter

After reaching a specified limit value the autoclaving counter generates a Sensoface message. As soon as the counter has reached the specified value, Sensoface is getting "sad". Pressing the info key shows the text "AUTOCLAVE CYCLES OVERRUN" which reminds you that the maximum number of autoclaving cycles has been reached. After each autoclaving process, you must manually increment the auto-claving counter in the SENSOR service menu. The transmitter displays "INCREMENT AUTOCLAVE CYCLE" as confirmation. You can configure the current outputs so that a Sensoface message generates a 22-mA error signal, see page 91.

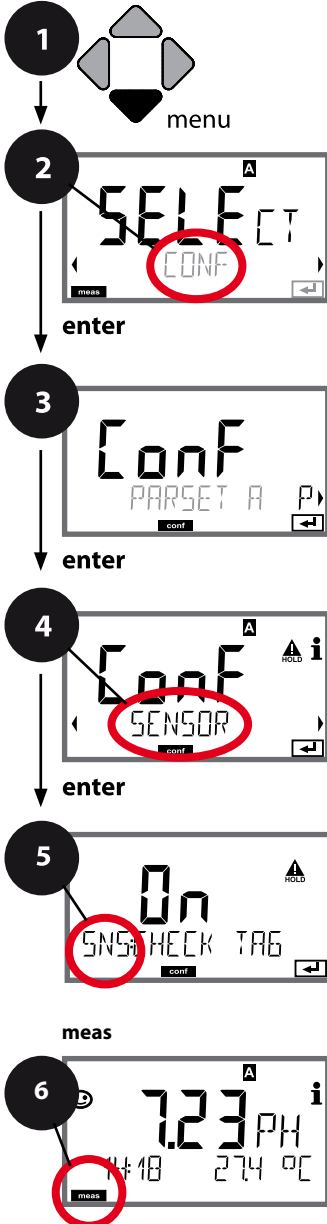

| Menu item | Action | Choices |
|---|--|---------------|
| Autoclaving counter | Select using ▲ ▼ : ON: Enter the number of cycles (0 ... 9999) Press enter to confirm. | OFF/ON |
|  | | |
| With the autoclaving counter switched on, you must increment the count after each autoclaving process in the SERVICE/SENSOR/AUTOCLAVE ... menu: | | |
| Incrementing the autoclaving counter (SERVICE menu) | After having completed an autoclaving process, open the SERVICE menu SENSOR / AUTOCLAVE to increment the autoclaving count. To do so, select "YES" and confirm by pressing enter . | NO/YES |
|  | | |

Sensor, Sensor Verification (TAG, GROUP)

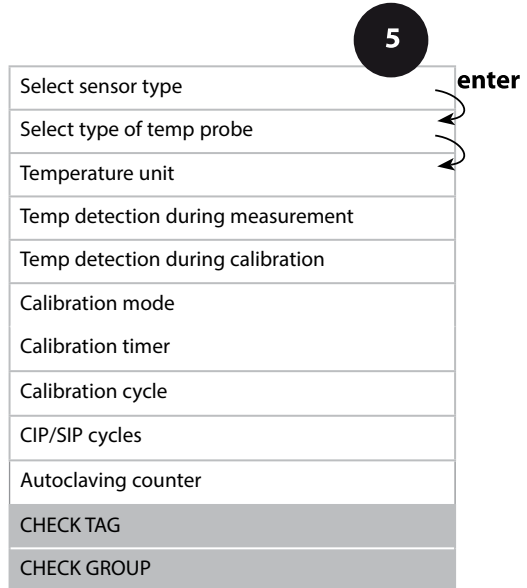

- 1 Press **menu** key.
- 2 Select **CONF** using ◀ ▶ , press **enter**.
- 3 Select parameter set using ◀ ▶ keys, press **enter**.
- 4 Select **SENSOR** menu using ◀ ▶ keys, press **enter**.
- 5 All items of this menu group are indicated by the "SNS:" code.
Press **enter** to select menu, edit using arrow keys (see next page). Confirm (and proceed) by pressing **enter**.
- 6 Exit: Press **meas** key until the [meas] mode indicator is displayed.



| Menu item | Action | Choices |
|--|--|---------------|
| <p>TAG</p>  | <p>Select ON or OFF using ▲ ▼ keys. Press enter to confirm.</p> <p>When switched on, the entry for "TAG" in the Memosens sensor is compared to the entry in the analyzer. If the entries differ, a message will be generated.</p> | <p>ON/OFF</p> |
| <p>GROUP</p>  | <p>Select ON or OFF using ▲ ▼ keys. Press enter to confirm.</p> <p>Function as described above</p> | <p>ON/OFF</p> |

Sensor Verification (TAG, GROUP)

When Memosens sensors are calibrated in the lab, it is often useful and sometimes even mandatory that these sensors will be operated again at the same measuring points or at a defined group of measuring points. To ensure this, you can save the respective measuring point (TAG) or group of measuring points (GROUP) in the sensor. TAG and GROUP can be specified by the calibration tool or automatically entered by the transmitter. When connecting an MS sensor to the transmitter, it can be checked if the sensor contains the correct TAG or belongs to the correct GROUP. If not, a message will be generated, Sensoface gets "sad", and the display backlighting turns magenta (purple). The "sad" Sensoface icon can also be signaled by a 22 mA error current. Sensor verification can be switched on in the Configuration in two steps as TAG and GROUP if required.

When no measuring point or group of measuring points is saved in the sensor, e.g., when using a new sensor, Stratos enters its own TAG and GROUP. When sensor verification is switched off, Stratos always enters its own measuring point and group. A possibly existing TAG/GROUP will be overwritten.

74

pH

MSPH

MSOXY

MSPH

MSPH

Connection of sensor A

| | | |
|---|---------------|------------|
| 1 | Brown | +3 V |
| 2 | Green | RS 485 A |
| 3 | Yellow | RS 485 B |
| 4 | White/Transp. | GND/shield |

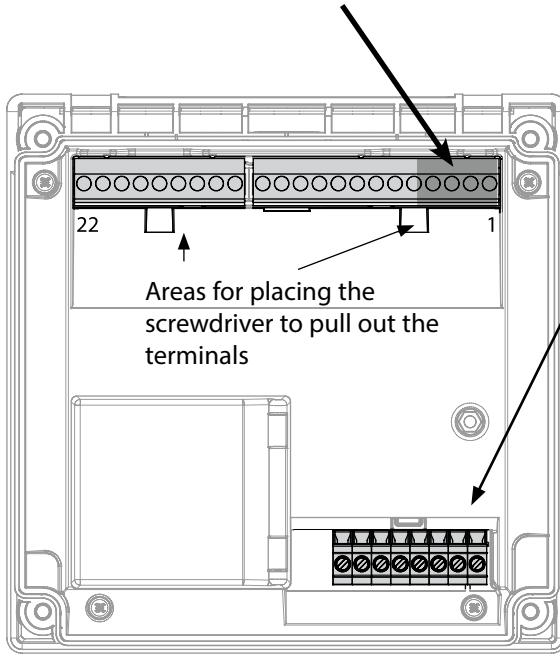

Connection of sensor B (2nd channel): (MK-MS095 module)

| | | |
|---|---------|----------|
| A | Brown | +3 V |
| B | Green | RS 485 A |
| C | Yellow | RS 485 B |
| D | White | GND |
| E | Transp. | SHIELD |

Memosens cable

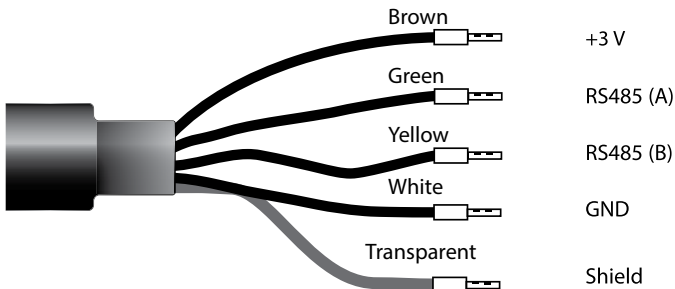

MSPH

MSPH

Sensors A and B – Typical Arrangement

(Connection of Memosens sensors: channel A via terminals on the device, channel B via MK-MS095 module)

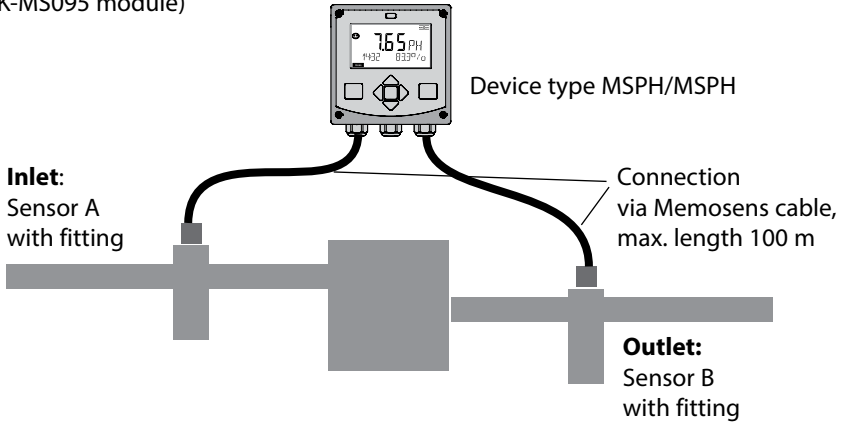

Channel selection and display assignment (example)

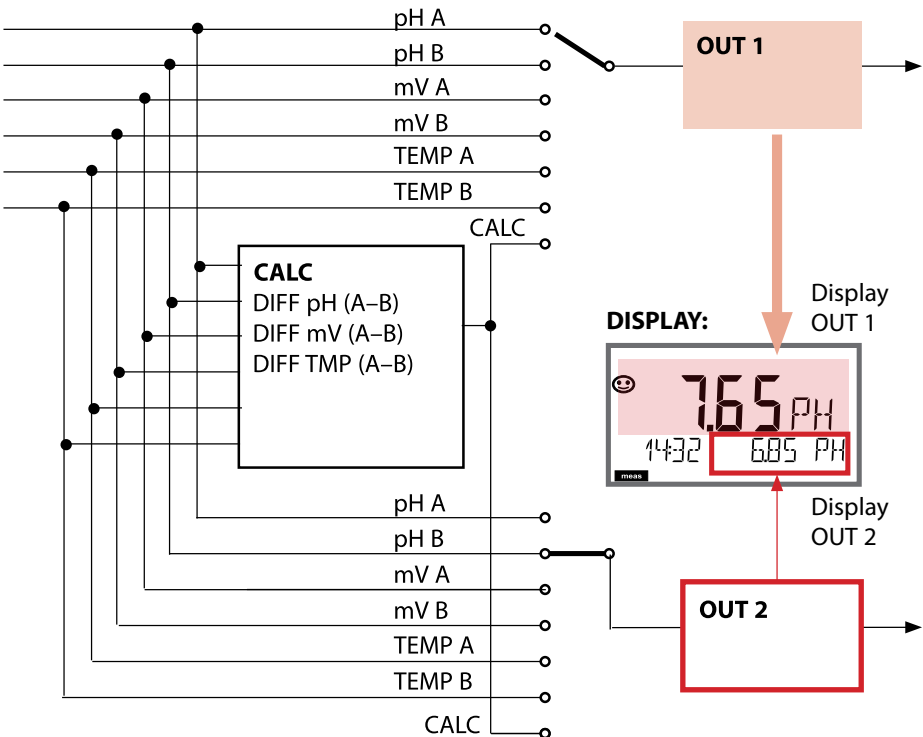

| Configuration | | Choices | Default |
|---|---|--|---------------------|
| Sensor A (see page 55 for details) | | | |
| S_A: | SENSOR | ON / OFF | ON |
| | CALMODE | AUTO / MAN / DAT | AUTO |
| | AUTO | BUFFER SET | -01- ... -10-, -U1- |
| | | Note: Pressing info displays nominal values and type of buffer set | |
| | U1 (For specifiable buffer set, see Appendix: "Buffer Tables") | EDIT BUFFER 1 (NO, YES) Enter values for buffer 1 | NO |
| | | EDIT BUFFER 2 (NO, YES) Enter values for buffer 2 | NO |
| | CAL TIMER | OFF, FIX, ADAPT | OFF |
| | ON | CAL-CYCLE | 0...9999 h |
| | CIP COUNT | ON/OFF | OFF |
| | SIP COUNT | ON/OFF | OFF |
| | AUTOCLAVE | ON/OFF | OFF |
| | CHECK TAG | ON/OFF | OFF |
| | CHECK GROUP | ON/OFF | OFF |
| Sensor B (see page 55 for details) | | | |
| S_B: | SENSOR | ON / OFF | OFF |
| | CALMODE | AUTO / MAN / DAT | AUTO |
| | AUTO | BUFFER SET | -01- ... -10-, -U1- |
| | | Note: Pressing info displays nominal values and type of buffer set | |
| | U1 (For specifiable buffer set, see Appendix: "Buffer Tables") | EDIT BUFFER 1 (NO, YES) Enter values for buffer 1 | NO |
| | | EDIT BUFFER 2 (NO, YES) Enter values for buffer 2 | NO |
| | CAL TIMER | OFF, FIX, ADAPT | OFF |
| | ON | CAL-CYCLE | 0...9999 h |
| | CIP COUNT | ON/OFF | OFF |
| | SIP COUNT | ON/OFF | OFF |
| | AUTOCLAVE | ON/OFF | OFF |
| | CHECK TAG | ON/OFF | OFF |
| | CHECK GROUP | ON/OFF | OFF |

MSPH

MSPH

| Configuration | | Choices | Default |
|------------------|----------------------------|---|-----------------------|
| MEAS_MODE | | | |
| MES: | TEMP UNIT | °C / °F | °C |
| | CALCULATION | ON/OFF | OFF |
| | ON (Selected in text line) | -C1- Difference PH -C2- Difference mV -C3- Difference TMP | -C1- Difference PH |

Calculations (CALC)

| CONF | Calculation | Formula | Display |
|------|-----------------|---------------|-----------|
| -C1- | pH difference | pH A – pH B | dPH |
| -C2- | mV difference | mV A – mV B | dmV |
| -C3- | Temp difference | TMP A – TMP B | d°C (d°F) |

MSPH

MSOXY

pH and Oxy measuring point (example)

(Connection of Memosens sensors: channel A (PH) via terminals on the device, channel B (OXY) via MK-MS module)

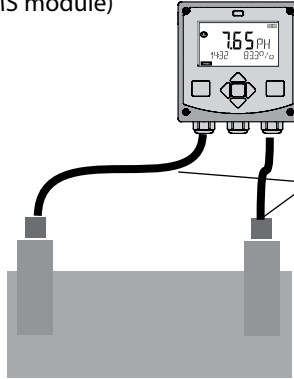

Device type MSPH/MSOXY

Connection via Memosens cable
Length max. 100 m

pH measurement:
pH sensor with fitting

Oxy measurement:
Oxy sensor with fitting

Channel selection and display assignment (example)

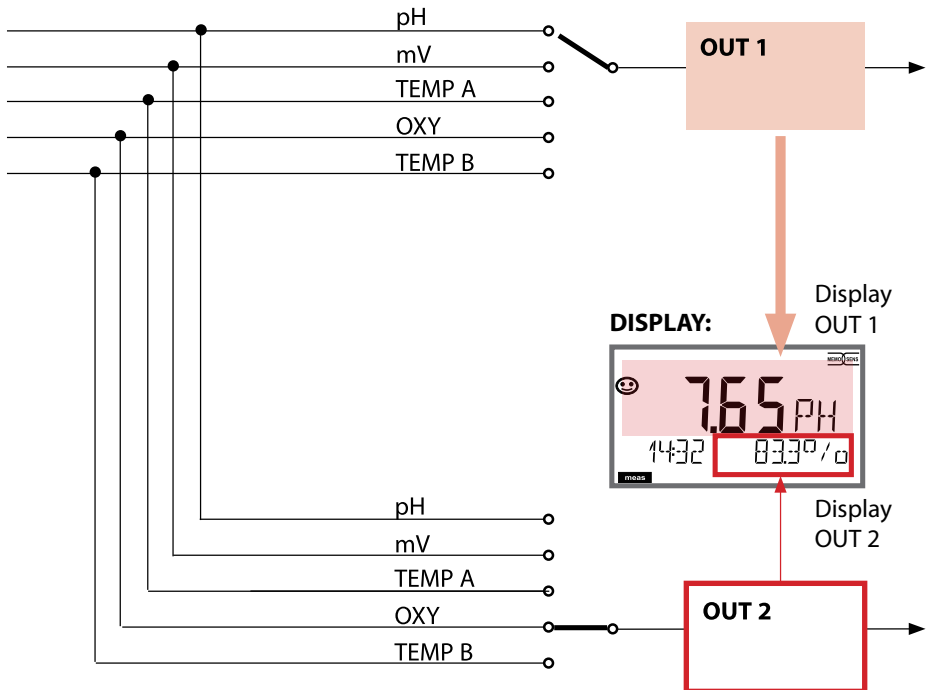

MSPH

MSOXY

Configuration (default in bold print)

| Sensor (see page 55/56 for details) | | pH | Oxy | |
|-------------------------------------|----------------|---------------------------|---|------------------------------------|
| SNS: | CALMODE | AUTO MAN DAT | | |
| | AUTO | BUFFER SET | | |
| | MEAS MODE* | | -01- MT -02- KNC ... -U1- USR ("info" shows nominal buffer values) | |
| | U-POL MEAS | | | dO % dO mg/l dO ppm GAS % |
| | U-POL CAL | | | -xxxx mV |
| | MEMBRANE COMP. | | | -xxxx mV |
| | TEMP UNIT | | °C / °F | xx.xx |
| Sensor | | pH | Oxy | |
| SNS: | CALTIMER | OFF / ON | | |
| | ON | CAL-CYCLE | 0 ... 9999 h (168 h) | |
| | ACT | | OFF / AUTO / MAN | |
| | MAN | ACT CYCLE | 0 ... 2000 DAY (0030 DAY) | |
| | TTM | | OFF / AUTO / MAN | |
| | MAN | TTM CYCLE | 0 ... 2000 DAY (0365 DAY) | |
| | CIP COUNT | | OFF / ON | |
| | ON | CIP CYCLES | 0 ... 9999 | |
| | SIP COUNT | | OFF / ON | |
| | ON | SIP CYCLES | 0 ... 9999 | |
| | AUTOCLAVE | | OFF / ON | |
| | ON | AC CYCLES | 0 ... 9999 | |
| | CHECK TAG | | OFF / ON | |
| | CHECK GROUP | | OFF / ON | |

* When the channel is disabled, MEAS_MODE = OFF, the sensor values will be set in such a way that no error message is generated.

MSPH

MSOXY

| Device Type: Oxy | | | |
|------------------------|---|------------|--|
| Oxy sensor | | Choices | Default |
| SNS: | SENSOR TYPE | | Memosens, LDO |
| | MEAS MODE | | dO %, dO mg/l dO ppm, GAS % |
| | U-POL | | -400...-1000 mV (0000...-1000 mV for traces) |
| | U-POL CAL | | |
| | MEMBR. COMP. | | 00.50...03.00 |
| | RTD TYPE | | 22 NTC 30 NTC |
| | TEMP UNIT | | °C / °F |
| | CAL MODE | | CAL AIR CAL WTR |
| | CAL TIMER | | ON/OFF |
| | ON | CAL-CYCLE | |
| Memosens LDO ISM | ACT (Adaptive Calibration Timer) (for ISM only) | | OFF / AUTO / MAN |
| | MAN | ACT CYCLE | 0...9999 DAY |
| | TTM (Time To Maintenance) (for ISM only) | | OFF / AUTO / MAN |
| | MAN | TTM CYCLE | 0...9999 DAY |
| | CIP COUNT | | ON/OFF |
| | ON | CIP CYCLES | 0...9999 CYC |
| | SIP COUNT | | ON/OFF |
| | ON | SIP CYCLES | 0...9999 CYC |
| | AUTOCLAVE | | ON/OFF |
| | ON | AC CYCLES | 0...9999 CYC |
| | CHECK TAG | | ON/OFF |
| | CHECK GROUP | | ON/OFF |

Oxy

Configuration (default in bold print)

| Current output 1 | | e.g., Oxy (if assigned as measured variable) | |
|------------------|-------------------------------|--|-----------------------------------|
| OT1: | RANGE | 4 ... 20 mA / 0 ... 20 mA | |
| | CHANNEL | OXY / TMP | |
| | OXY dO % | BEGIN 4 mA (0 mA) | 000.0 ... 600.0 % |
| | | END 20 mA | 000.0 ... 600.0 % |
| | OXY dO mg/l | BEGIN 4 mA (0 mA) | 0000 µg/l ... 99.99 mg/l |
| | | END 20 mA | 0000 µg/l ... 99.99 mg/l |
| | OXY dO ppm | BEGIN 4 mA (0 mA) | 0000 ppb ... 99.99 ppm |
| | | END 20 mA | 0000 ppb ... 99.99 ppm |
| | OXY GAS % | BEGIN 4 mA (0 mA) | 0000 ppm ... 99.99 % |
| | | END 20 mA | 0000 ppm ... 99.99 % |
| | TMP °C | BEGIN 4 mA (0 mA) | - 20 ... 150 °C / 000.0 °C |
| | | END 20 mA | - 20 ... 150 °C / 100.0 °C |
| | TMP °F | BEGIN 4 mA (0 mA) | - 4 ... 302 °C / 032.0 °F |
| | | END 20 mA | - 4 ... 302 °C / 212.0 °F |
| | FILTERTIME | 0...120 SEC / 120 SEC | |
| FAIL 22 mA | ON / OFF | | |
| FACE 22 mA | ON / OFF | | |
| HOLD MODE | LAST / FIX | | |
| FIX HOLD-FIX | 4 ... 22 mA / 021.0 mA | | |

Correction

Oxy

| | | |
|------|-----------------|--|
| COR: | SALINITY | 00.00 ... 45.00 ppt (00.00 ppt) |
| | PRESSURE UNIT | BAR / KPA / PSI |
| | PRESSURE | MAN / EXT. (with SW-A005 "External current input" option only) |
| | BAR PRESSURE | 0.000 ... 9.999 BAR (1.013 BAR) |
| | KPA PRESSURE | 000.0 ... 999.9 KPA (100 KPA) |
| | PSI PRESSURE | 000.0 ... 145.0 PSI (14.5 PSI) |

| Configuration (default in bold print) | | | |
|---------------------------------------|-----------------------|---|---------------------------------------|
| Current output 2 | | e.g., pH (if assigned as measured variable) | |
| OT2: | RANGE | 4 ... 20 mA 0 ... 20 mA | |
| | CHANNEL | PH ORP TEMP rH | |
| | PH | BEGIN (0)4 mA | - 2.00 ... 16.00 pH / 00.00 pH |
| | | END 20 mA | - 2.00 ... 16.00 pH / 14.00 pH |
| | ORP (Redox-Sensor) | BEGIN (0)4 mA | - 1999 ... 1999 mV / - 1000 mV |
| | | END 20 mA | - 1999 ... 1999 mV / 1000 mV |
| | TMP °C | BEGIN (0)4 mA | - 20 ... 300 °C / 000.0 °C |
| | | END 20 mA | - 20 ... 300 °C / 100.0 °C |
| | TMP °F | BEGIN (0)4 mA | - 4 ... 572 °C / 032.0 °F |
| | | END 20 mA | - 4 ... 572 °C / 212.0 °F |
| | rH | BEGIN (0)4 mA | 000.0 ... 200.0 rH |
| | | END 20 mA | 000.0 ... 200.0 rH |
| | FILTRTIME | | 0 ... 120 SEC |
| | FAIL 22 mA | | ON / OFF |
| | FACE 22 mA | | ON / OFF |
| | HOLD MODE | LAST / FIX | Last measured value is maintained |
| FIX | | 0 ... 22 mA (021.0 mA) | |

| Correction | | pH |
|------------|-----------|--|
| COR: | TC SELECT | OFF LIN PURE WTR |
| | LIN | TC LIQUID - 19.99 ... 19.99 %/K 00.00 %/K |

Configuration (default in bold print)**CNTR_IN input**

| | | | |
|----|---------|-------------|--|
| IN | CONTROL | | PARSET / FLOW |
| | FLOW | FLOW ADJUST | 0 ... 20000 pulses/liter (12000 pulses/liter) |

Alarm

| | | | |
|-----|------------|---|---|
| ALA | DELAYTIME | | 0 ... 600 s (0010 SEC) |
| | SENSOCHECK | | ON / OFF |
| | FLOW CNTR | | ON / OFF |
| | ON | FLOW MIN | 0 ... 99.9 Liter/h (005.0 Liter/h) |
| | FLOW MAX | 0 ... 99.9 Liter/h (025.0 Liter/h) | |

Relay contacts REL1, REL2

| | | | | |
|-----|---|--|---|--|
| REL | LIMITS CONTROLLER | The following submenu depends on the selected setting. | | |
| RL1 | CHANNEL | PH / ORP / TMP | OXY / TMP / FLOW | |
| | FUNCTION | Lo LEVEL / Hi LEVEL | | |
| | CONTACT | N/O / N/C | | |
| | LEVEL | 00.00 pH -2.00 ... 16.00 pH (-1999 ... 1999 mV) (-20 ... 200 °C) | 000.0 % 000.0 ... 600.0 % 0000 µg/l ... 99.99 mg/l 0000 ppb ... 99.99 ppm 0000 ppm ... 99.99 % (-20 ... 150 °C) | |
| | HYSTERESIS | 00.50 pH 0.00 ... 10.00 pH (0 ... 2000 mV) (0 ... 100 °C / 0 ... 180 °F) | 000.0 % 0 ... 50 % full scale | |
| | DELAYTIME | 0010 SEC 0000 ... 9999 s | | |
| RL2 | See RL1 for configuration; default setting: CHANNEL = TMP | | | |

Configuration (default in bold print)

| PID controller | | pH |
|----------------|-----------|--|
| CTR | CHANNEL | PH / ORP / TMP |
| | TYPE | PLC / PFC |
| | PLC | 00001 ... 0600 s (0010 s) |
| | PFC | 0001 ... 0180 min ⁻¹ (0060 min⁻¹) |
| | SETPOINT | within measuring range |
| | DEAD BAND | 0 ... 50 % full scale |
| | P-GAIN | 10 ... 999 % (0100 %) |
| | I-TIME | 0 ... 9999 s (0000 s) |
| | D-TIME | 0 ... 9999 s (0000 s) |
| | HOLD MODE | Y LAST / Y OFF |

Rinse contact WASH

| | | |
|-----|-----------------------------|---|
| WSH | WASH / PARSET A/B | Rinse contact / Signaling the active parameter set |
| | WASH CYCLE | 0.0 ... 999.9 h (000.0 h) |
| | WASH TIME | 0 ... 1999 s (0060 s) |
| | RELAX TIME | 0000 ... 1999 s (0030 s) |
| | CONTACT | N/O / N/C |

Selecting the parameter set PARSET

| | | |
|-----|--------------------------------------|---|
| PAR | PARSET FIX A MANUAL CNTR INPUT | (no switchover, parameter set A) (manual selection in the "Configuration" menu) (switchover via CNTR control input) |
|-----|--------------------------------------|---|

Time/date

| | | |
|-----|-------------|---|
| CLK | FORMAT | 24 h / 12 h |
| | 24 h | hh:mm |
| | 12 h | hh:mm (AM / PM) 00 ... 12:59 AM / 1 ... 11:59 PM |
| | DAY / MONTH | dd.mm |
| | YEAR | 2000 ... 2099 |

Measuring points (TAG / GROUP)

| | | |
|-------|--|-----------------------------|
| TAG | The entries are made in the text line. | A...Z, 0...9, - + < > ? / @ |
| GROUP | The entries are made in the text line. | 0000...9999 |

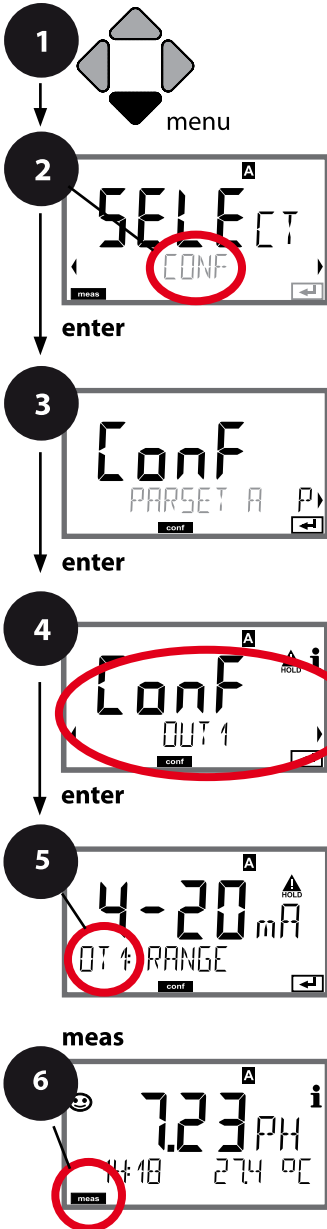

Output Current, Range, Current Start, Current End



- 1 Press **menu** key.
- 2 Select **CONF** using $\leftarrow \rightarrow$, press **enter**.
- 3 Select parameter set using $\leftarrow \rightarrow$ keys, press **enter**.
- 4 Select **OUT1** menu using $\leftarrow \rightarrow$ keys, press **enter**.
- 5 All items of this menu group are indicated by the "OT1:" code. Press **enter** to select menu, edit using arrow keys (see next page). Confirm (and proceed) by pressing **enter**.
- 6 Exit: Press **meas** key until the [meas] mode indicator is displayed.

| | | |
|---|--------------------------------------|-------|
| 5 | Current range | enter |
| | Process variable | ↔ |
| | Current start | ↔ |
| | Current end | |
| | Time averaging filter | |
| | Output current during error message | |
| | Output current for Sensoface message | |
| | Output current during HOLD | |
| | Output current for HOLD FIX | |

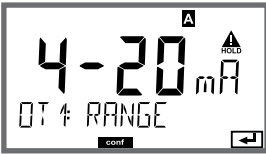
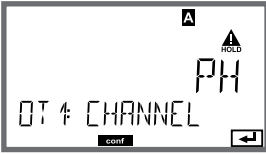
5

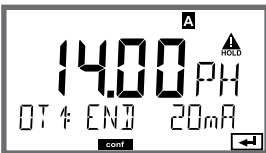
| Menu item | Action | Choices |
|---|---|--|
| <p>Current range</p>  | <p>Select 4-20 mA or 0-20 mA range using \blacktriangle \blacktriangledown keys.</p> <p>Press enter to confirm.</p> | <p>4-20 mA / 0-20 mA</p> |
| <p>Process variable</p>  | <p>Example: current output 1, device type pH</p> <p>Select using \blacktriangle \blacktriangledown keys:</p> <p>PH: pH value ORP: ORP value TMP: Temperature</p> <p>Press enter to confirm.</p> | <p>PH/ORP/TMP</p> |
| <p>Current start</p>  | <p>Modify digit using \blacktriangle \blacktriangledown keys, select next digit using \blacktriangleleft \blacktriangleright keys.</p> <p>Press enter to confirm.</p> | <p>-2...16 pH (PH) -1999...1999 mV (ORP) -20...300 °C / -4...572 °F (TMP)</p> |
| <p>Current end</p>  | <p>Enter value using \blacktriangle \blacktriangledown \blacktriangleleft \blacktriangleright keys.</p> <p>Press enter to confirm.</p> | <p>-2...16 pH (PH) -1999...1999 mV (ORP) -20...300 °C / -4...572 °F (TMP)</p> |

Assignment of measured values: Current start and current end

Example 1: Range pH 0...14

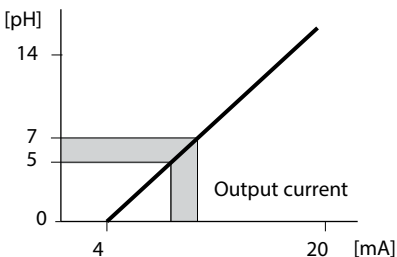

Example 2: Range pH 5...7

Advantage: Higher resolution in range of interest

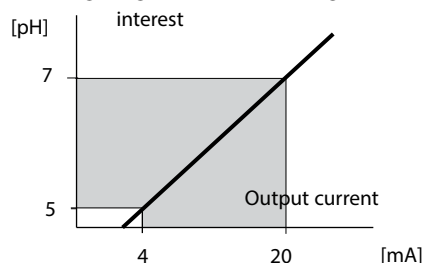

Output Current, Time Averaging Filter

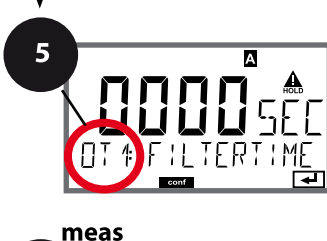
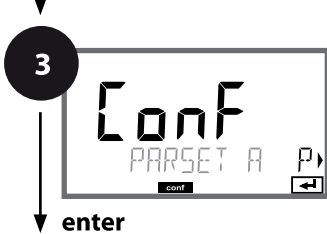

- 1 Press **menu** key.
- 2 Select **CONF** using $\leftarrow \rightarrow$, press **enter**.
- 3 Select parameter set using $\leftarrow \rightarrow$ keys, press **enter**.
- 4 Select **OUT1** menu using $\leftarrow \rightarrow$ keys, press **enter**.
- 5 All items of this menu group are indicated by the "OT1:" code. Press **enter** to select menu, edit using arrow keys (see next page). Confirm (and proceed) by pressing **enter**.
- 6 Exit: Press **meas** key until the [meas] mode indicator is displayed.

5

| | |
|--------------------------------------|-------|
| Current range | enter |
| Process variable | enter |
| Current start | enter |
| Current end | |
| Time averaging filter | |
| Output current during error message | |
| Output current for Sensoface message | |
| Output current during HOLD | |
| Output current for HOLD FIX | |

5

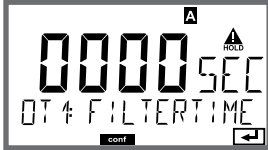
| Menu item | Action | Choices |
|--|---|---------------------------|
| Time averaging filter  | Enter value using ▲ ▼ ◀ ▶ keys. Press enter to confirm. | 0...120 SEC (0000 SEC) |

Time averaging filter

To smoothen the current output, a low-pass filter with adjustable filter time constant can be switched on. When there is a jump at the input (100 %), the output level is at 63 % after the time interval has been reached. The time interval can be set from 0 to 120 sec. If the time interval is set to 0 sec, the current output directly follows the input.

Note:

The filter only acts on the current output, not on the display, the limit values, or the controller!

During HOLD the filter is not applied. This prevents a jump at the output.

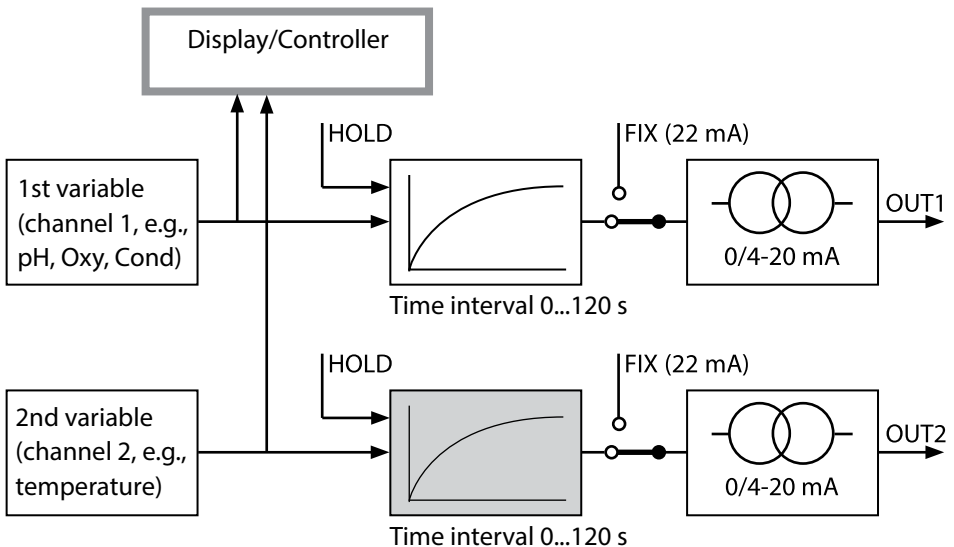

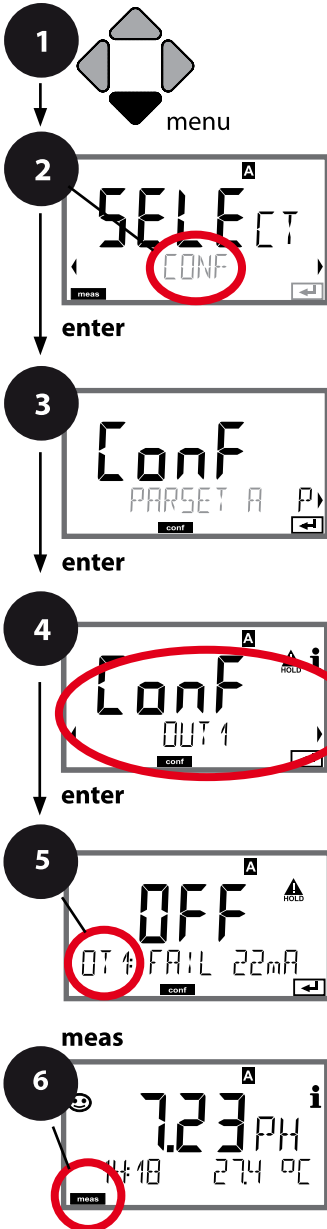

Output Current, Error and HOLD



- 1 Press **menu** key.
- 2 Select **CONF** using $\leftarrow \rightarrow$, press **enter**.
- 3 Select parameter set using $\leftarrow \rightarrow$ keys, press **enter**.
- 4 Select **OUT1** menu using $\leftarrow \rightarrow$ keys, press **enter**.
- 5 All items of this menu group are indicated by the "OT1:" code.
Press **enter** to select menu, edit using arrow keys (see next page). Confirm (and proceed) by pressing **enter**.
- 6 Exit: Press **meas** key until the [meas] mode indicator is displayed.

| | | |
|---|--------------------------------------|-------|
| 5 | Current range | enter |
| | Process variable | ↻ |
| | Current start | ↻ |
| | Current end | |
| | Time averaging filter | |
| | Output current during error message | |
| | Output current for Sensoface message | |
| | Output current during HOLD | |
| | Output current for HOLD FIX | |

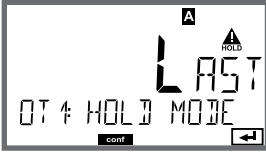
5

| Menu item | Action | Choices |
|--|---|---------------------------------------|
| Output current during error message  | The output current can be set to 22 mA in the case of error messages. Select ON or OFF using \blacktriangle \blacktriangledown . Press enter to confirm. | OFF / ON |
| Output current during Sensoface messages OT1: FACE 22 mA | The output current can be set to 22 mA in the case of Sensoface messages. Select ON or OFF using \blacktriangle \blacktriangledown . Press enter to confirm. | OFF / ON |
| Output current during HOLD  | LAST: During HOLD the last measured value is maintained at the output. FIX: During HOLD a value (to be entered) is maintained at the output. Select using \blacktriangle \blacktriangledown . Press enter to confirm. | LAST/FIX |
| Output current for HOLD FIX  | Only with FIX selected: Enter current which is to flow at the output during HOLD Enter value using \blacktriangle \blacktriangledown \blacktriangleleft \blacktriangleright . Press enter to confirm. | 00.00...22.00 mA (21.00 mA) |

Output signal during HOLD:

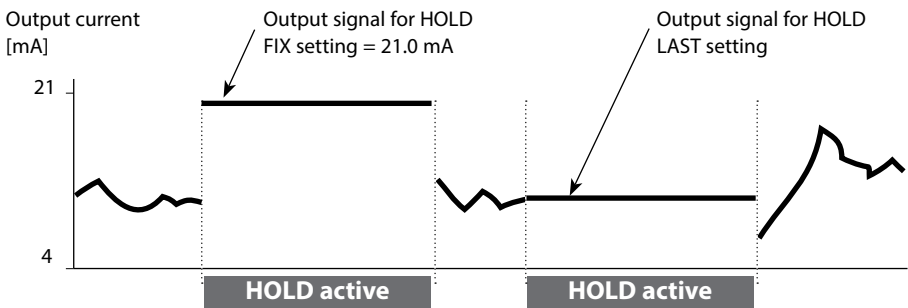

Temperature Compensation of Process Medium (pH)

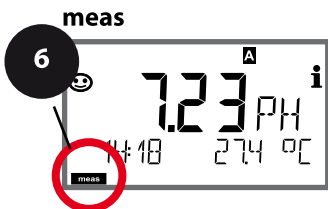

- 1 Press **menu** key.
- 2 Select **CONF** using **◀ ▶**, press **enter**.
- 3 Select parameter set using **◀ ▶** keys, press **enter**.
- 4 Select **CORRECTION** menu using **◀ ▶** keys, press **enter**.
- 5 All items of this menu group are indicated by the "COR:" code. Confirm (and proceed) by pressing **enter**.
- 6 Exit: Press **meas** key until the [meas] mode indicator is displayed.

5

pH temp compensation
Process medium (linear)

5

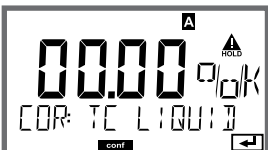
| Menu item | Action | Choices |
|---|--|----------------------------|
| <p>Temperature compensation of process medium</p>  | <p>For pH measurement only: Select temperature compensation of the process medium. Linear: LIN Select using \leftarrow \rightarrow, press enter to confirm.</p> | <p>OFF / LIN</p> |
| <p>Temperature compensation, linear</p>  | <p>Enter the linear temperature compensation of the process medium. Enter value using \uparrow \downarrow \leftarrow \rightarrow keys Press enter to confirm.</p> | <p>-19.99...+19.99 %/K</p> |

Parameter Set Selection (External Signal)*

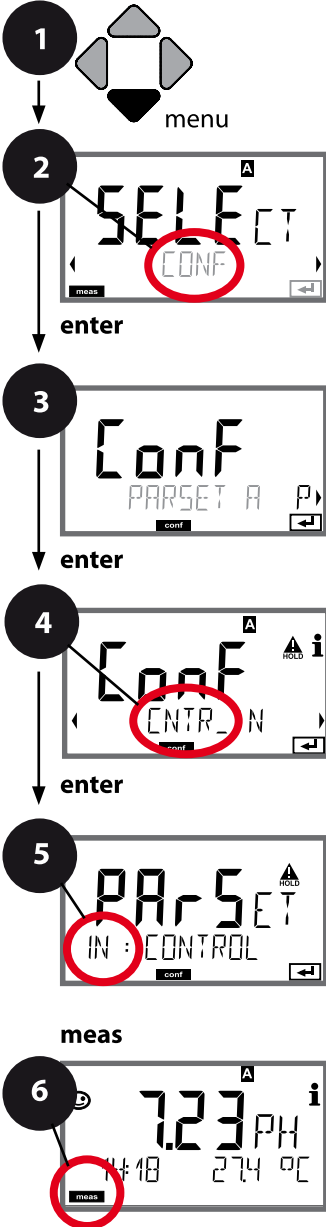

- 1 Press **menu** key.
- 2 Select **CONF** using ◀ ▶, press **enter**.
- 3 Select parameter set A using ◀ ▶ keys, press **enter**.
- 4 Select **CNTR_IN** menu using ◀ ▶ keys, press **enter**.
- 5 All items of this menu group are indicated by the "IN:" code.
Press **enter** to select menu, edit using arrow keys (see next page). Confirm (and proceed) by pressing **enter**.
- 6 Exit: Press **meas** key until the [meas] mode indicator is displayed.

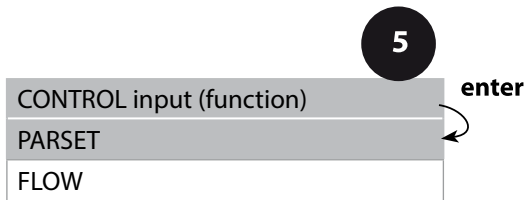

*) not for MSPH/MSPH and MSPH/MOXY devices

5

| Menu item | Action | Choices |
|---|---|--|
| Select function of CONTROL input  | Select using ◀ ▶ keys, confirm by pressing enter | PARSET FIX A / MANUAL / CNTR INPUT (selecting parameter set A/B via signal at CONTROL input) |

External switchover of parameter sets

The parameter set A/B can be activated from outside by sending a signal to the CONTROL input (e.g., from the process control system).

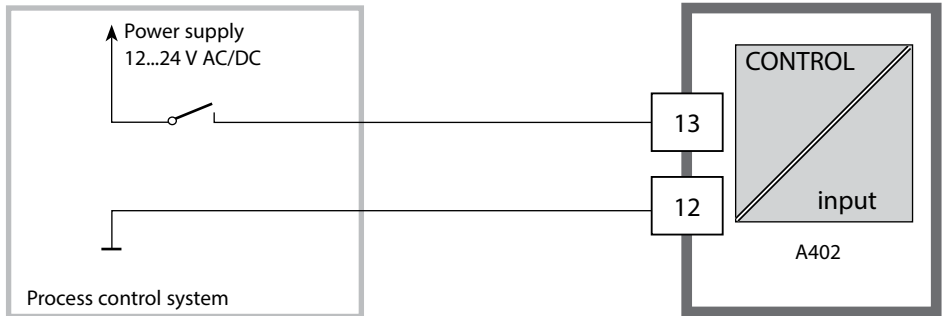

| | |
|-----------------|-----------------|
| Parameter set A | 0...2 V AC/DC |
| Parameter set B | 10...30 V AC/DC |

Flow Measurement

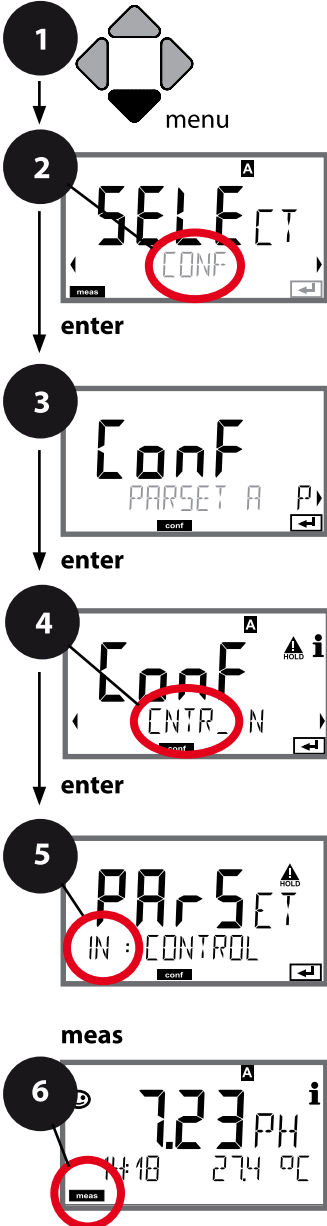



- 1 Press **menu** key.
- 2 Select **CONF** using ◀ ▶ , press **enter**.
- 3 Select parameter set A using ◀ ▶ keys, press **enter**.
- 4 Select **CNTR_IN** menu using ◀ ▶ keys, press **enter**.
- 5 All items of this menu group are indicated by the "IN:" code. Press **enter** to select menu, edit using arrow keys (see next page). Confirm (and proceed) by pressing **enter**.
- 6 Exit: Press **meas** key until the [meas] mode indicator is displayed.

5

| | |
|--------------------------|------------|
| CONTROL input (function) | enter ↻ |
| PARSET / FLOW | |
| FLOW: ADJUST | |

5

| Menu item | Action | Choices |
|---|---|--|
| Select function of CONTROL input  | Select using ▲ ▼ keys, confirm by pressing enter | PARSET (selecting parameter set A/B via signal at CONTROL input) |
|  | | Flow (for connecting a pulse-output flow meter) |
| Adjust to flow meter:  | With "Flow" selected, you must adjust the device to the flow meter used. Enter value using arrow keys, confirm by pressing enter | 12000 pulses/liter |

In the alarm menu you can configure flow monitoring. When you have set CONTROL to FLOW, you can specify 2 additional limit values for maximum and minimum flow. If the measured value lies outside this range, an alarm message and a 22-mA error signal (if configured) will be generated.

Note: The response speed may be reduced because the values are averaged.

Display

Flow measurement in measuring mode



Display

Flow measurement (sensor monitor)



Alarm, Alarm Delay, Sensocheck

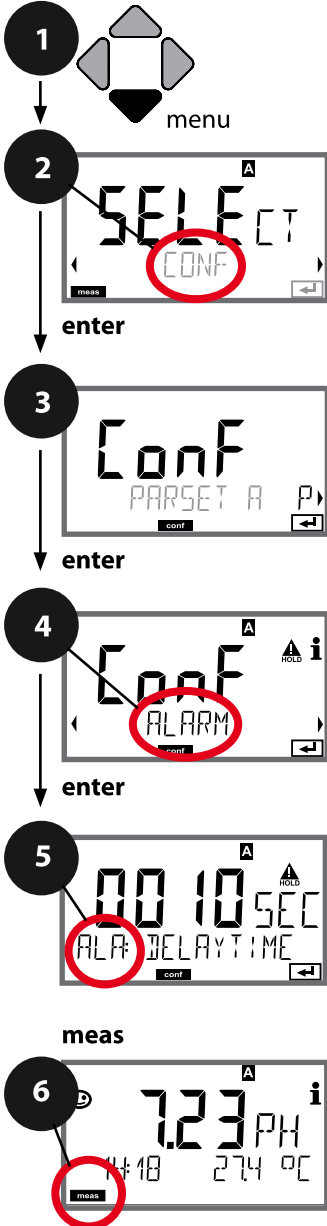



- 1 Press **menu** key.
- 2 Select **CONF** using ◀ ▶ , press **enter**.
- 3 Select parameter set using ◀ ▶ keys, press **enter**.
- 4 Select **ALARM** menu using ◀ ▶ keys, press **enter**.
- 5 All items of this menu group are indicated by the "ALA:" code. Press **enter** to select menu, edit using arrow keys (see next page). Confirm (and proceed) by pressing **enter**.
- 6 Exit: Press **meas** key until the [meas] mode indicator is displayed.

5

| | |
|-----------------------|-------|
| Delay | enter |
| Sensocheck | enter |
| Alarm: CONTROL input | |
| With flow monitoring: | |
| Max. flow alarm | |
| With flow monitoring: | |
| Min. flow alarm | |

5

| Menu item | Action | Choices |
|--|--|--------------------------|
| Alarm delay  | Enter alarm delay using ▲ ▼ ◀ ▶ keys. Press enter to confirm. | 0...600 SEC (010 SEC) |
| Sensocheck  | Select Sensocheck (continuous monitoring of sensor membrane and lines). Select ON or OFF using ▲ ▼ keys. Press enter to confirm. (At the same time, Sensoface is activated. With OFF, Sensoface is also switched off.) | ON/OFF |

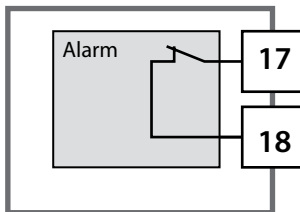

Alarm contact

The alarm contact is closed during normal operation (N/C). It opens in the case of alarm or power outage. As a result, a failure message is output even in the case of line breakage (fail-safe behavior). For contact ratings, see Specifications.

Error messages can also be signaled by a 22-mA output current (see Error messages and Configuration Output 1/Output 2).

Operating behavior of the alarm contact: see Operating States table.

The alarm delay time delays the color change of the display backlighting to red, the 22-mA signal (if configured), and the alarm contact switching.

Alarm, CONTROL Input (FLOW MIN, FLOW MAX)

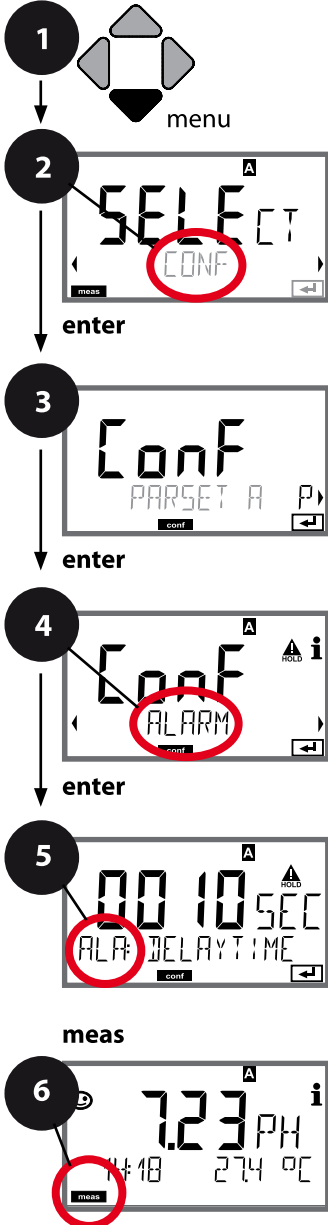

- 1 Press **menu** key.
- 2 Select **CONF** using ◀ ▶, press **enter**.
- 3 Select parameter set using ◀ ▶ keys, press **enter**.
- 4 Select **ALARM** menu using ◀ ▶ keys, press **enter**.
- 5 All items of this menu group are indicated by the "ALA:" code. Press **enter** to select menu, edit using arrow keys (see next page). Confirm (and proceed) by pressing **enter**.
- 6 Exit: Press **meas** key until the [meas] mode indicator is displayed.

5

| | |
|--|-------|
| Alarm: Delay | enter |
| Alarm: Sensocheck | |
| Alarm: CONTROL input | |
| With flow monitoring: Max. flow alarm | |
| With flow monitoring: Min. flow alarm | |

5

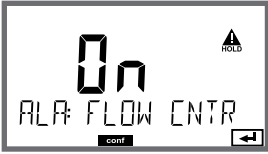
| Menu item | Action | Choices |
|--|--|--|
| CONTROL input  | The CONTROL input can generate an alarm when assigned to "FLOW" (flow monitoring) in the CONF menu: FLOW CNTR Flow measurement: allows monitoring the minimum and maximum flow (pulse counter) | ON/OFF (FLOW MIN, FLOW MAX.) |
| Alarm Minimum flow FLOW MIN | Specify value | Default: 05.00 liters/h |
| Alarm Maximum flow FLOW MAX | Specify value | Default: 25.00 liters/h |

Limit Function, Relay 1

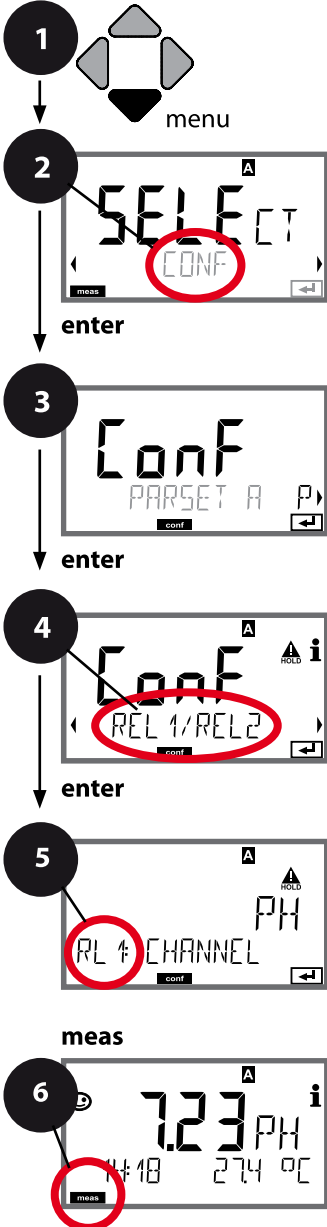





- 1 Press **menu** key.
- 2 Select **CONF** using ◀ ▶, press **enter**.
- 3 Select parameter set using ◀ ▶, press **enter**.
- 4 Select **REL1/REL2** menu using ◀ ▶ keys, press **enter**.
- 5 All items of this menu group are indicated by the "RL1:" code.
Press **enter** to select menu, edit using arrow keys (see next page). Confirm (and proceed) by pressing **enter**.
- 6 Exit: Press **meas** key until the [meas] mode indicator is displayed.

5

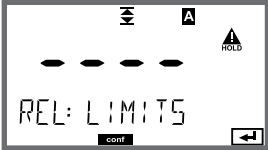
| | |
|--|-------|
| Use of relays | enter |
| Select process variable | enter |
| Limit 1 switching characteristics (function) | enter |
| Limit 1 contact type | |
| Limit 1 setpoint | |
| Limit 1 hysteresis | |
| Limit 1 delay | |

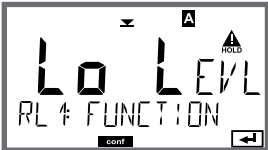
5

| Menu item | Action | Choices |
|---|---|--|
| <p>Use of relays</p>  | <p>Select in the text line using ▲ ▼ keys:</p> <ul style="list-style-type: none"> • Limit function (LIMITS) • Controller (CONTROLLER) <p>Press enter to confirm.</p> | <p>LIMITS / CONTROLLER</p> <p>Note: Selecting CONTROLLER leads to Controller menu group CTR.</p> |
| <p>Select process variable</p>  | <p>Select desired process variable using ▲ ▼ keys.</p> <p>Press enter to confirm.</p> | <p>Depending on module or Memosens sensor</p> |
| <p>Limit 1 function</p>  | <p>Select desired function using arrow keys.</p> <p>LoLevel: active if value falls below setpoint LoLevel: active if value exceeds setpoint</p> <p>Press enter to confirm.</p> | <p>Lo LEVEL / Hi LEVEL</p> <p>Limit 1 icon: ▼</p> |
| <p>Limit 1 contact response</p>  | <p>N/O: normally open contact N/C: normally closed contact</p> <p>Select using ▲ ▼ keys.</p> <p>Press enter to confirm.</p> | <p>N/O / N/C</p> |
| <p>Limit 1 setpoint</p>  | <p>Enter setpoint using ▲ ▼ ◀ ▶ keys.</p> <p>Press enter to confirm.</p> | <p>Depending on module or Memosens sensor</p> |

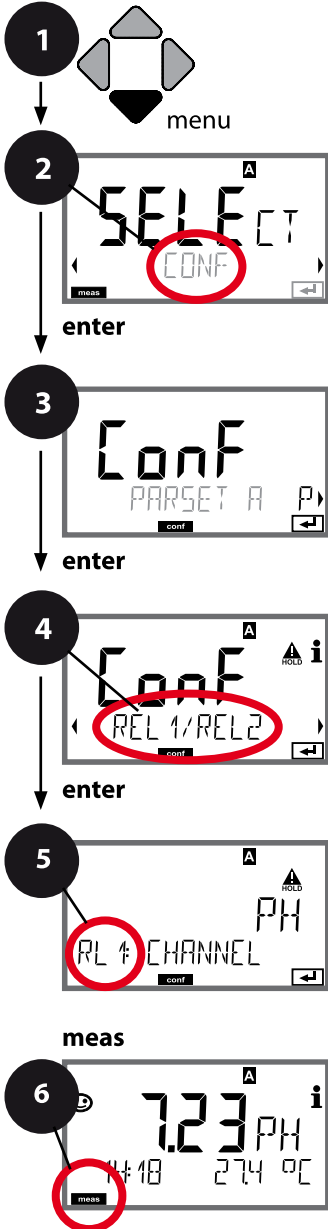

Limit Function, Relay 1

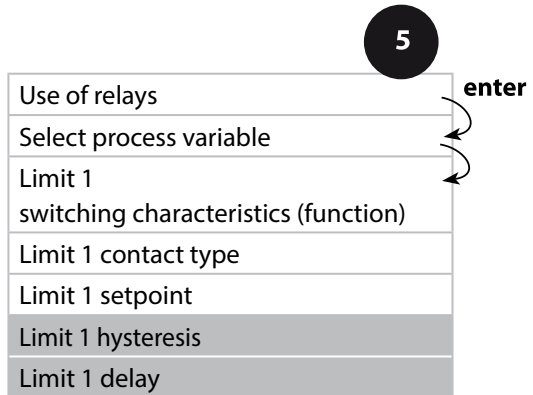

- 1 Press **menu** key.
- 2 Select **CONF** using ◀ ▶, press **enter**.
- 3 Select parameter set using ◀ ▶ keys, press **enter**.
- 4 Select **REL1/REL2** menu using ◀ ▶ keys, press **enter**.
- 5 All items of this menu group are indicated by the "RL1:" code. Press **enter** to select menu, edit using arrow keys (see next page). Confirm (and proceed) by pressing **enter**.
- 6 Exit: Press **meas** key until the [meas] mode indicator is displayed.

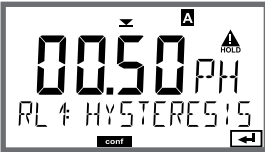

5

| Menu item | Action | Choices |
|---|--|--|
| Limit 1 hysteresis  | Select hysteresis using \uparrow \downarrow \leftarrow \rightarrow keys. Press enter to confirm. | Depending on module or Memosens sensor |
| Limit 1 delay  | The contact is activated with delay (deactivated without delay) Adjust delay using \uparrow \downarrow \leftarrow \rightarrow keys. Press enter to confirm. | 0...9999 SEC (0010 SEC) |

Application of Hysteresis:

Limit Lo

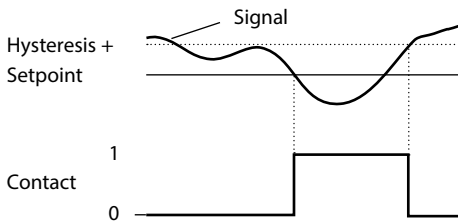

Limit Hi

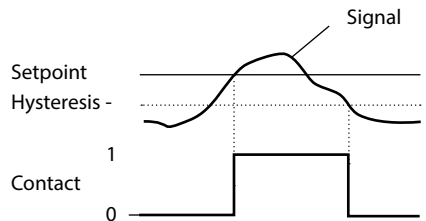

Limit Function, Relay 2

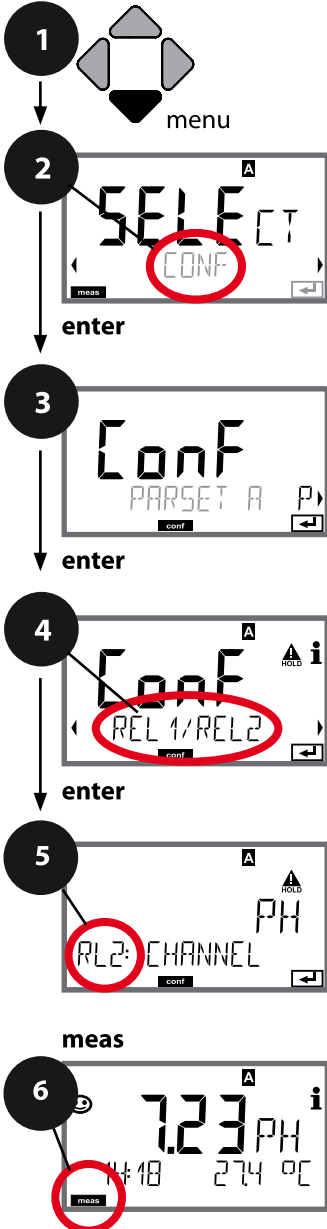

- 1 Press **menu** key.
- 2 Select **CONF** using ◀ ▶ , press **enter**.
- 3 Select parameter set using ◀ ▶ keys, press **enter**.
- 4 Select **REL1/REL2** menu using ◀ ▶ keys, press **enter**.
- 5 All items of this menu group are indicated by the "RL2:" code.
Press **enter** to select menu, edit using arrow keys (see next page). Confirm (and proceed) by pressing **enter**.
- 6 Exit: Press **meas** key until the [meas] mode indicator is displayed.

5 Use of relays

Select process variable

Limit 2 switching characteristics (function)

Limit 2 contact type

Limit 2 setpoint

Limit 2 hysteresis

Limit 2 delay

enter

5

| Menu item | Action | Choices |
|-----------------------------------|---|---|
| Select process variable (CHANNEL) | Select desired process variable using \blacktriangle \blacktriangledown keys. Press enter to confirm. | Depending on module or Memosens sensor |
| Limit 2 function (FUNCTION) | Select desired function using arrow keys. Press enter to confirm. | Lo LEVEL / Hi LEVEL Limit 2 icon: \blacktriangle |
| Limit 2 contact type (CONTACT) | N/O: normally open contact N/C: normally closed contact Select using \blacktriangle \blacktriangledown keys. Press enter to confirm. | N/O / N/C |
| Limit 2 setpoint (LEVEL) | Enter setpoint using \blacktriangle \blacktriangledown \blacktriangleleft \blacktriangleright keys. Press enter to confirm. | Depending on module or Memosens sensor |
| Limit 2 hysteresis (HYSTERESIS) | Select hysteresis using \blacktriangle \blacktriangledown \blacktriangleleft \blacktriangleright keys. Press enter to confirm. | Depending on module or Memosens sensor |
| Limit 2 delay (DELAYTIME) | The contact is activated with delay (deactivated without delay) Adjust delay using \blacktriangle \blacktriangledown \blacktriangleleft \blacktriangleright keys. Press enter to confirm. | 0...9999 SEC (0010 SEC) |

Application of Hysteresis:

Limit Lo

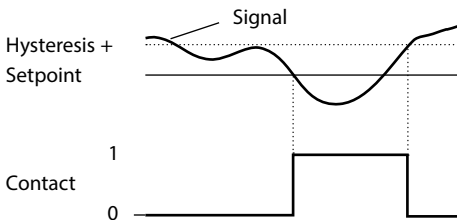

Limit Hi

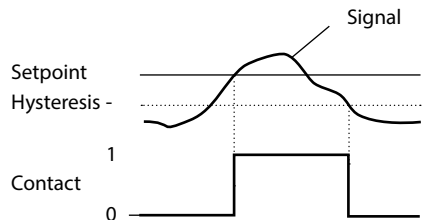

Protective Wiring of Relay Contacts

Relay contacts are subject to electrical erosion. Especially with inductive and capacitive loads, the service life of the contacts will be reduced. For suppression of sparks and arcing, components such as RC combinations, nonlinear resistors, series resistors and diodes should be used.

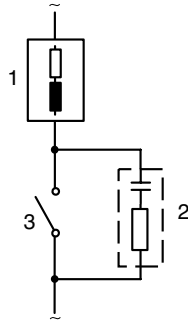
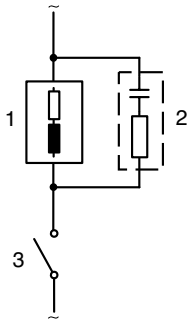

Typical AC applications with inductive load

- 1 Load
- 2 RC combination,
e.g., RIFA PMR 209
Typical RC combinations for
230 V AC:
capacitor 0.1 μF / 630 V,
resistor 100 Ω / 1 W
- 3 Contact

Typical Protective Wiring Measures

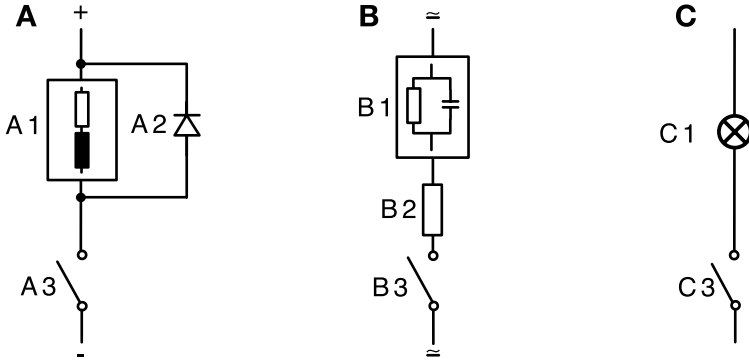

- A:** DC application with inductive load
- B:** AC/DC applications with capacitive load
- C:** Connection of incandescent lamps

- A1 Inductive load
- A2 Free-wheeling diode, e.g., 1N4007 (Observe polarity)
- A3 Contact
- B1 Capacitive load
- B1 Resistor, e.g., $8\ \Omega / 1\ \text{W}$ at $24\ \text{V} / 0.3\ \text{A}$
- B3 Contact
- C1 Incandescent lamp, max. $60\ \text{W} / 230\ \text{V}$, $30\ \text{W} / 115\ \text{V}$
- C3 Contact



WARNING!

Make sure that the maximum ratings of the relay contacts are not exceeded even during switching!

Typical Applications

P controller

Application for integrating control systems (e.g., closed tank, batch processes).

PI controller

Application for non-integrating control systems (e.g., drains).

PID controller

The additional derivative action compensates for measurement peaks.

Controller Characteristic

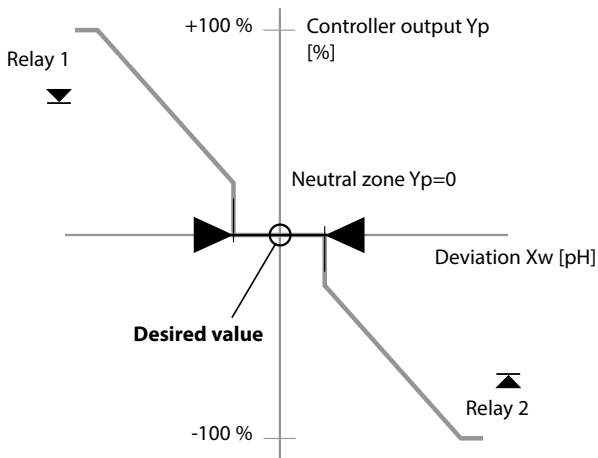

Controller Equations

$$\text{Controller output } Y = \underbrace{Y_P}_{\text{P action}} + \underbrace{\frac{1}{T_R} \int Y_P dt}_{\text{I action}} + \underbrace{T_D \frac{dY_P}{dt}}_{\text{D action}}$$

with:

| | |
|----------|--------------------------------|
| Y_P | Proportional action |
| T_N | Reset time [s] |
| T_D | Rate time [s] |
| K_C | Controller gain [%] |
| Constant | 5 (for pH) 500 mV (for ORP) |

Proportional action Y_P

$$Y_P = \frac{\text{Setpoint} - \text{Meas. value}}{\text{Constant}} * K_C$$

Neutral Zone

Tolerated deviation from desired value.
 With the setting "1 pH", for example, a deviation of ± 0.5 pH from the desired value is tolerated.

Proportional Action (Gradient K_C [%])

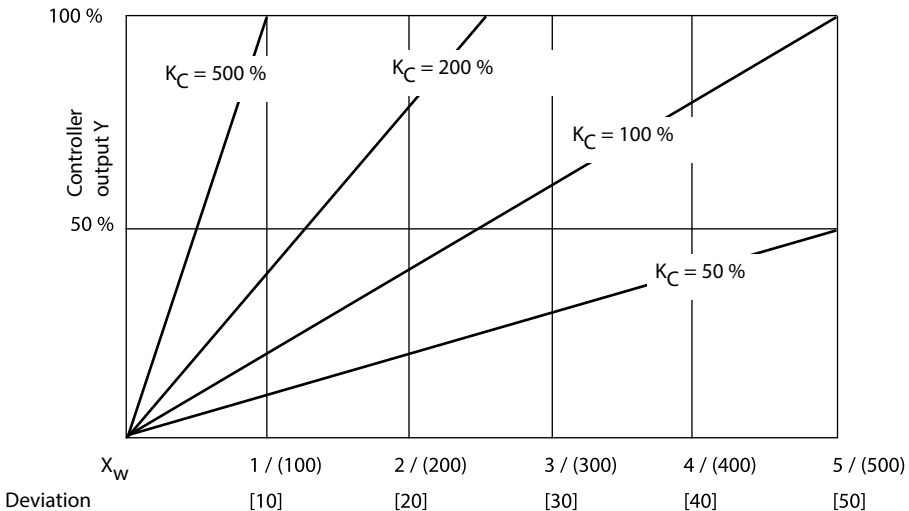

Process variables: pH/ (mV),
 underneath: temp [K]

Pulse Length / Pulse Frequency Controller

Pulse Length Controller (PLC)

The pulse length controller is used to operate a valve as an actuator. It switches the contact on for a time that depends on the controller output. The period is constant. A minimum ON time of 0.5 sec is maintained even if the controller output takes corresponding values.

Output signal (relay contact) of pulse length controller

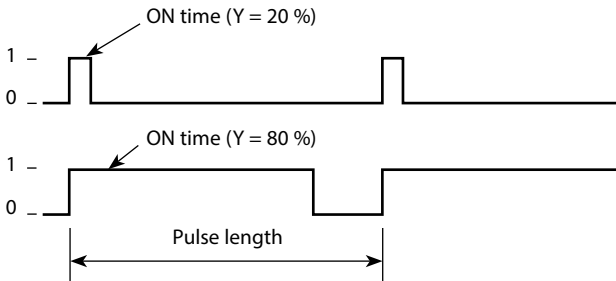

Pulse Frequency Controller (PFC)

The pulse frequency controller is used to operate a frequency-controlled actuator (metering pump). It varies the frequency with which the contacts are switched on. The maximum pulse frequency [pulses/min] can be defined. It depends on the actuator. The contact ON time is constant. It is automatically calculated from the user-defined maximum pulse frequency:

Output signal (relay contact) of pulse frequency controller

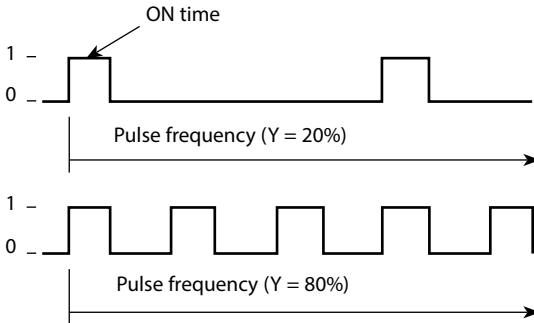

PID controller and behavior during HOLD

The following setting can be made for the controller: HOLD MODE = Y LAST/Y OFF.

Y LAST: The controller output Y is maintained during HOLD

Y OFF: Y = 0 during HOLD (no control)

For a continuous (non-integrating) process, you should use the Y LAST setting.

For an integrating process (closed boiler), you should use Y OFF.

Controller, Process Variable, Controller Type, Setpoint

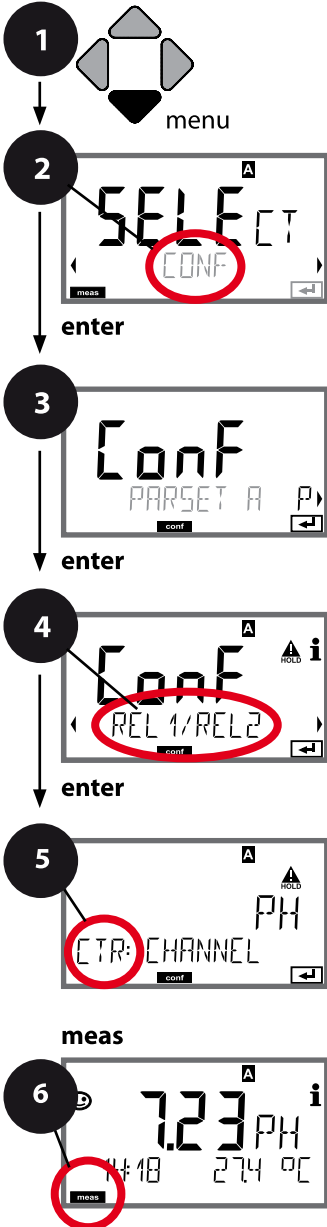

- 1 Press **menu** key.
- 2 Select **CONF** using ◀ ▶, press **enter**.
- 3 Select parameter set using ◀ ▶ keys, press **enter**.
- 4 Select **REL1/REL2** menu using ◀ ▶ keys, press **enter**.
- 5 All items of this menu group are indicated by the “CTR:” code.
Press **enter** to select menu, edit using arrow keys (see next page). Confirm (and proceed) by pressing **enter**.
- 6 Exit: Press **meas** key until the [meas] mode indicator is displayed.

| | | |
|---|-------------------------|-------|
| 5 | Use of relays | enter |
| | Select process variable | ↩ |
| | Controller type | ↩ |
| | Pulse length | |
| | Pulse frequency | |
| | Desired value | |
| | Neutral zone | |
| | Controller: P action | |
| | Controller: I action | |
| | Controller: D action | |
| | Behavior during HOLD | |

5

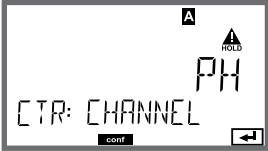
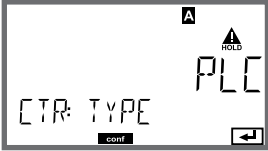
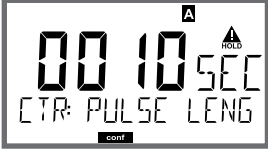
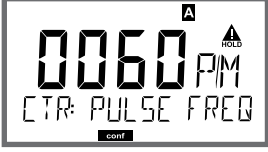
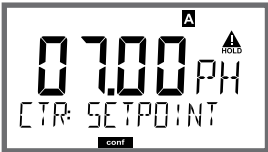
| Menu item | Action | Choices |
|--|---|--|
| Use of relays | Select in the text line using ▲ ▼ keys: • Controller (CONTROLLER) Press enter to confirm. | LIMITS / CONTROLLER Selecting CONTROLLER leads to Controller menu group CTR. |
| Select process variable  | Select desired process variable using ▲ ▼ keys. Press enter to confirm. | Depending on module or Memosens sensor |
| Controller type  | Pulse length controller (PLC) or pulse frequency controller (PFC) Select using ▲ ▼ keys. Press enter to confirm. | PLC/PFC |
| Pulse length  | Only with PLC: Pulse length Adjust using ▲ ▼ ◀ ▶ keys. Press enter to confirm. | 0...0600 SEC (0010 SEC) |
| Pulse frequency  | Only with PFC: Pulse frequency Adjust using ▲ ▼ ◀ ▶ keys. Press enter to confirm. | 0...0180 P/M (0060 P/M) (pulses per minute) |
| Desired value  | Adjust setpoint using ▲ ▼ ◀ ▶ keys. Press enter to confirm. | Depending on module or Memosens sensor |

Controller, Neutral Zone, P, I, D Action Components, Behavior during HOLD

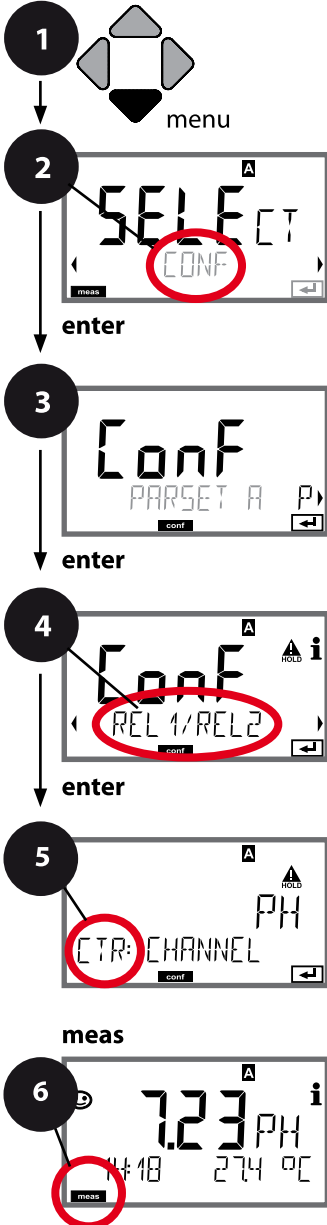



- 1 Press **menu** key.
- 2 Select **CONF** using ◀ ▶ , press **enter**.
- 3 Select parameter set using ◀ ▶ keys, press **enter**.
- 4 Select **REL1/REL2** menu using ◀ ▶ keys, press **enter**.
- 5 All items of this menu group are indicated by the "CTR:" code.
Press **enter** to select menu, edit using arrow keys (see next page). Confirm (and proceed) by pressing **enter**.
- 6 Exit: Press **meas** key until the [meas] mode indicator is displayed.

5

| | |
|-------------------------|-------|
| Use of relays | enter |
| Select process variable | |
| Controller type | |
| Pulse length | |
| Pulse frequency | |
| Desired value | |
| Neutral zone | |
| Controller: P action | |
| Controller: I action | |
| Controller: D action | |
| Behavior during HOLD | |

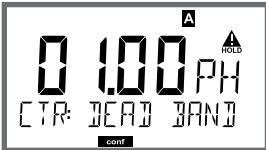
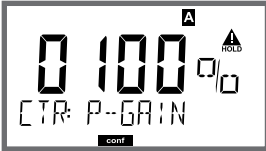
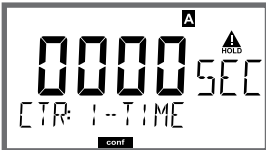
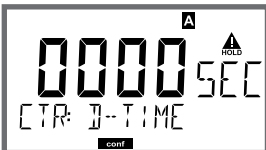
5

| Menu item | Action | Choices |
|--|--|--|
| <p>Neutral zone</p>  | <p>Adjust neutral zone using ▲ ▼ ◀ ▶ keys.</p> <p>Press enter to confirm.</p> | <p>Depending on module or Memosens sensor</p> |
| <p>Controller: P action</p>  | <p>Adjust P action using ▲ ▼ ◀ ▶ keys.</p> <p>Press enter to confirm.</p> | <p>10...9999% (0100%)</p> |
| <p>Controller: I action</p>  | <p>Adjust I action using ▲ ▼ ◀ ▶ keys.</p> <p>Press enter to confirm.</p> | <p>0...9999 SEC (0000 SEC)</p> |
| <p>Controller: D action</p>  | <p>Adjust D action using ▲ ▼ ◀ ▶ keys.</p> <p>Press enter to confirm.</p> | <p>0...9999 SEC (0000 SEC)</p> |
| <p>Behavior during HOLD*</p>  | <p>Select response using ▲ ▼ keys.</p> <p>Press enter to confirm.</p> | <p>Y LAST / Y OFF Y LAST: The controller output Y is maintained during HOLD Y OFF: Y = 0 during HOLD (no control)</p> |

***) PID controller and behavior during HOLD**

For a continuous (non-integrating) process, you should use the Y LAST setting.

For an integrating process (closed boiler), you should use Y OFF.

WASH Contact, Controlling a Rinsing Probe or Signaling the Parameter Set

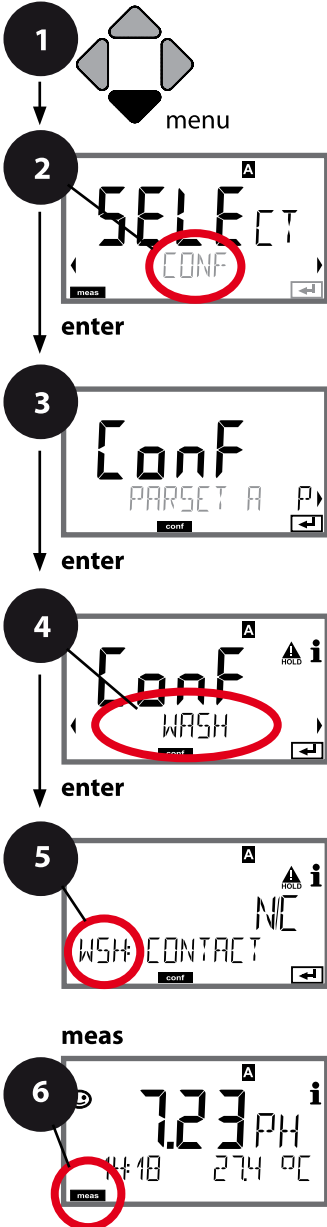



- 1 Press **menu** key.
- 2 Select **CONF** using ◀ ▶ , press **enter**.
- 3 Select parameter set A using ◀ ▶ keys, press **enter**.
- 4 Select **WASH** menu using ◀ ▶ keys, press **enter**.
- 5 All items of this menu group are indicated by the "WSH:" code. Press **enter** to select menu, edit using arrow keys (see next page). Confirm (and proceed) by pressing **enter**.
- 6 Exit: Press **meas** key until the [meas] mode indicator is displayed.

5

| | |
|-------------------|-------|
| Function | enter |
| Cleaning interval | ↻ |
| Cleaning duration | ↻ |
| Relax time | |
| Contact type | |

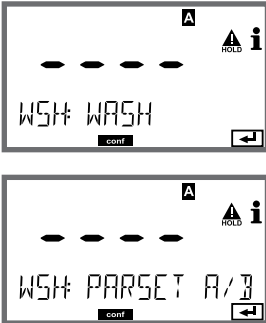
5

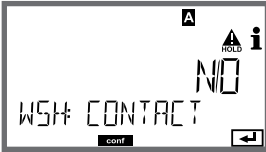
| Menu item | Action | Choices |
|---|--|--|
| <p>Function</p>  | <p>Select WASH contact function using ▲ ▼ keys.</p> <p>Press enter to confirm.</p> | <p>WASH / PARSET A/B</p> <p>WASH: Controlling a rinsing probe</p> <p>With PARSET A/B selected, the contact signals: "Parameter set A" (open contact) "Parameter set B" (closed contact)</p> |
| <p>Cleaning interval</p>  | <p>Only with WASH: Adjust value using ▲ ▼ ◀ ▶ keys.</p> <p>Press enter to confirm.</p> | <p>0.0...999.9 h (000.0 h)</p> |
| <p>Cleaning duration</p>  | <p>Only with WASH: Adjust value using ▲ ▼ ◀ ▶ keys.</p> <p>Press enter to confirm.</p> | <p>0...9999 SEC (0060 SEC)</p> <p>Relax time: 0000...1999 SEC (0030 SEC)</p> |
| <p>Contact type</p>  | <p>Only with WASH: N/O: normally open contact N/C: normally closed contact Select using ▲ ▼ keys. Press enter to confirm.</p> | <p>N/O / N/C</p> |

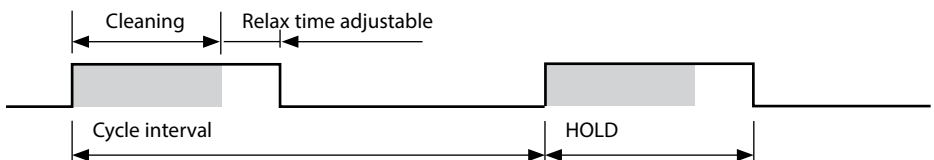

Time and Date, Measuring Point

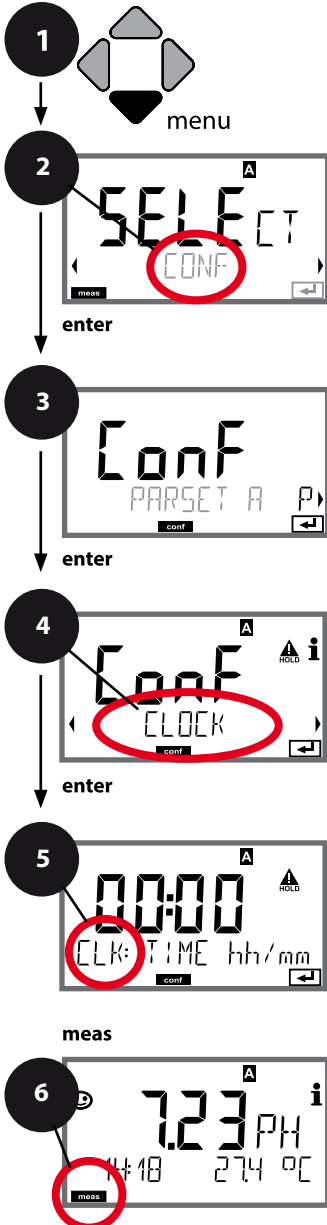

- 1 Press **menu** key.
- 2 Select **CONF** using **◀ ▶**, press **enter**.
- 3 Select parameter set A using **◀ ▶** keys, press **enter**.
- 4 Select **CLOCK** or **TAG** using **◀ ▶** keys, press **enter**.
- 5 All items of this menu group are indicated by the "CLK:" or "TAG" code.
Press **enter** to select menu, edit using arrow keys (see next page). Confirm (and proceed) by pressing **enter**.
- 6 Exit: Press **meas** key until the [meas] mode indicator is displayed.

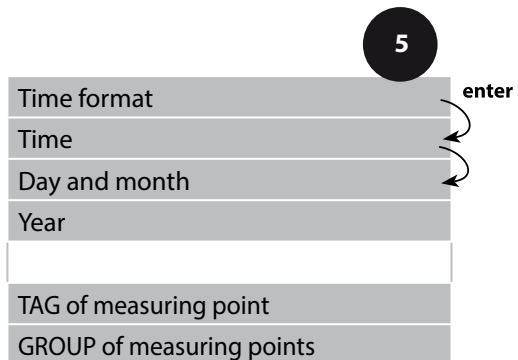

Time and Date

Control of the calibration and cleaning cycles is based on the time and date of the integrated real-time clock.

In measuring mode the time is shown in the lower display. When using digital sensors, the calibration data is written in the sensor head. In addition, the logbook entries (cf Diagnostics) are provided with a time stamp.

Note:

There is no automatic switchover from winter to summer time!

Be sure to manually adjust the time!

Sensor Verification (TAG, GROUP)

When Memosens sensors are calibrated in the lab, it is often useful and sometimes even mandatory that these sensors will be operated again at the same measuring points or at a defined group of measuring points. To ensure this, you can save the respective measuring point (TAG) or group of measuring points (GROUP) in the sensor. TAG and GROUP can be specified by the calibration tool or automatically entered by the transmitter. When connecting an MS sensor to the transmitter, it can be checked if the sensor contains the correct TAG or belongs to the correct GROUP. If not, a message will be generated, Sensoface gets "sad", and the display backlighting turns magenta (purple). The "sad" Sensoface icon can also be signaled by a 22 mA error current. Sensor verification can be switched on in the Configuration in two steps as TAG and GROUP if required.

When no measuring point or group of measuring points is saved in the sensor, e.g., when using a new sensor, Stratos enters its own TAG and GROUP. When sensor verification is switched off, Stratos always enters its own measuring point and group. A possibly existing TAG/GROUP will be overwritten.

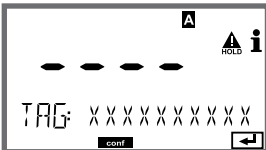
| Menu item | Action | Choices |
|---|---|--|
| <p>TAG of measuring point</p>  | <p>In the lower display line you can enter a designation for the measuring point (TAG) and for a group of measuring points (GROUP) if applicable. Up to 32 digits are possible. By pressing meas (repeatedly) in the measuring mode you can view the tag number. Select character using ▲ ▼ keys, select next digit using ◀ ▶ keys. Press enter to confirm.</p> | <p>A...Z, 0...9, - + < > ? / @</p> <p>The first 10 characters are seen in the display without scrolling.</p> |
| <p>GROUP of measuring points</p> | <p>Select number using ▲ ▼ keys, select next digit using ◀ ▶ keys. Confirm by pressing enter</p> | <p>0000 ... 9999 (0000)</p> |

pH

Note:

- All calibration procedures must be performed by trained personnel. Incorrectly set parameters may go unnoticed, but change the measuring properties.
- The response time of the sensor and temperature probe is considerably reduced when the sensor is first moved about in the buffer solution and then held still.

The device can only operate properly when the buffer solutions used correspond to the configured set. Other buffer solutions, even those with the same nominal values, may demonstrate a different temperature response.

This leads to measurement errors.

When using ISFET sensors or sensors with a zero point other than pH 7, the nominal zero point must be adjusted each time a new sensor is connected. This is important if you want to obtain reliable Sensoface messages. The Sensoface messages issued during all further calibrations are based on this basic calibration.

Calibration is used to adapt the device to the individual sensor characteristics, namely asymmetry potential and slope.

Access to calibration can be protected with a passcode (SERVICE menu).

First, you open the calibration menu and select the calibration mode:

(With MSPH-MSPH multichannel operation, you have to select the sensor first.)

| | | | | | | | |
|------------|---|------|--|-----|---------------------|-----|-------------------------------------|
| CAL_PH | Depending on configuration setting: <table border="1"> <tr> <td>AUTO</td> <td>Automatic buffer recognition (Calimatic)</td> </tr> <tr> <td>MAN</td> <td>Manual buffer input</td> </tr> <tr> <td>DAT</td> <td>Input of premeasured electrode data</td> </tr> </table> | AUTO | Automatic buffer recognition (Calimatic) | MAN | Manual buffer input | DAT | Input of premeasured electrode data |
| AUTO | Automatic buffer recognition (Calimatic) | | | | | | |
| MAN | Manual buffer input | | | | | | |
| DAT | Input of premeasured electrode data | | | | | | |
| CAL_ORP | ORP calibration | | | | | | |
| P_CAL | Product calibration (calibration with sampling) | | | | | | |
| ISFET-ZERO | Zero adjustment. Required for ISFET sensors. Subsequently you can conduct either a one or a two-point calibration. | | | | | | |
| CAL_RTD | Temperature probe adjustment | | | | | | |

To preset CAL_PH (CONF menu / configuration):

- 1) Hold **meas** key depressed (> 2 sec) (measuring mode)
- 2) Press **menu** key: the selection menu appears
- 3) Select CONF mode using left / right arrow key
- 4) Select "SENSOR" – "CALMODE": AUTO, MAN, or DAT.

Press **enter** to confirm.

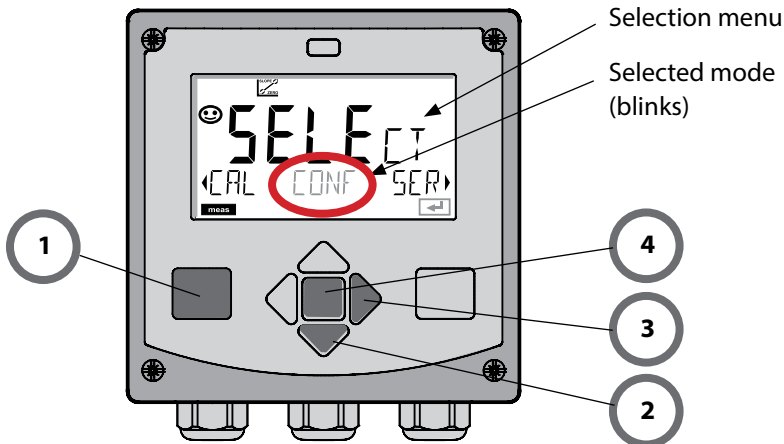





pH



This adjustment allows the use of ISFET sensors with differing nominal zero (pH only). The function is available when ISFET has been select during configuration. Zero adjustment is disabled for any other sensors.

The adjustment is made using a zero buffer (pH 7.00).

Permitted range for buffer value: pH 6.5 ... 7.5. Temperature-corrected input.

Maximum zero offset: ± 200 mV.

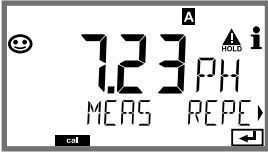
| Display | Action | Remark |
|--|---|--|
|  The display shows 'CAL' in large characters, 'ISFET-ZERO' below it, and a small icon in the top right corner. Navigation arrows are visible at the bottom. | Select Calibration. Press enter to proceed. | |
|  The display shows 'CAL' in large characters, 'ISFET-ZERO' below it, and a 'HOLD' icon (hourglass) in the top right corner. Navigation arrows are visible at the bottom. | Ready for calibration. Hourglass blinks. | Display (3 sec) Now the device is in HOLD mode. |
|  The display shows '7.00' in large characters, 'BUF' to the right, '127mV' and '27.3°C' below. A 'HOLD' icon is in the top right. Navigation arrows are visible at the bottom. | Immerse sensor in a pH 7.00 buffer. Enter the temperature-corrected pH value in the range 6.50 to 7.50 using the arrow keys (see buffer table). Press enter to confirm. | If the zero offset of the sensor is too large ($> \pm 200$ mV), a CAL ERR error message is generated. In that case the sensor cannot be calibrated. |
|  The display shows '7.00' in large characters, 'BUF' to the right, '128mV' and '27.3°C' below. A 'HOLD' icon (hourglass) is in the top right and is blinking. Navigation arrows are visible at the bottom. | Stability check. The measured value [mV] is displayed. The "hourglass" icon is blinking. | Note: Stability check can be stopped (by pressing enter). However, this reduces calibration accuracy. |





| Display | Action | Remark |
|--|--|--|
|  The display shows a smiley face icon on the left, the number '129' in large digits, 'mV' to its right, and '15FET-ZERO' below. There are 'cal' and 'hold' indicators and arrow keys at the bottom. | At the end of the adjustment procedure the zero offset [mV] of the sensor is displayed (based on 25 °C). Sensoface is active. Press enter to proceed. | This is not the final calibration value of the sensor! Asymmetry potential and slope must be determined with a complete 2-point calibration. |
|  The display shows a smiley face icon on the left, the number '7.23' in large digits, 'pH' to its right, and 'MEAS REPE' below. There are 'cal' and 'hold' indicators and arrow keys at the bottom. | Use the arrow keys to select: <ul style="list-style-type: none"> • Repeat (repeat calibration) or • Measure Press enter to confirm. | |
|  The display shows a smiley face icon on the left, the number '7.23' in large digits, 'pH' to its right, and 'GOOD BYE' below. There are 'cal' and 'hold' indicators and arrow keys at the bottom. | Place sensor in process. Press enter to exit zero calibration. | After end of calibration, the outputs remain in HOLD mode for a short time. |





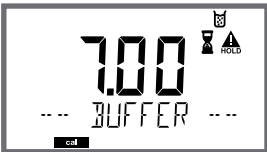

Note for Zero Adjustment

After having adjusted the zero offset, be sure to calibrate the sensor following one of the procedures as described on the next pages.

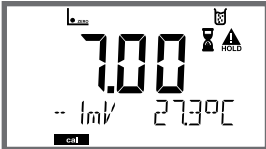
pH

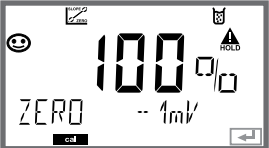

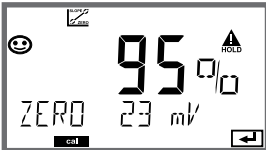

The AUTO calibration mode must have been preset during **configuration**. Make sure that the buffer solutions used correspond to the configured buffer set. Other buffer solutions, even those with the same nominal values, may demonstrate a different temperature response. This leads to measurement errors.





| Display | Action | Remark |
|--|--|--|
|  | Select Calibration. Press enter to proceed. | |
|  | Ready for calibration. Hourglass blinks. Select calibration method: CAL_PH Press enter to proceed. | Display (3 sec) Now the device is in HOLD mode. |
|  | Remove the sensor, clean it, and immerse it in the first buffer solution (it does not matter which solution is taken first). Press enter to start. | |
|  | Buffer recognition. While the "hourglass" icon is blinking, the sensor remains in the first buffer solution. | To reduce the sensor response time, first move it about in the buffer solution and then hold it still. |
|  | Buffer recognition termi- nated, the nominal buffer value is displayed, then zero point and temperature. | |

| Display | Action | Remark |
|---|--|--|
|  | <p>Stability check. The measured value [mV] is displayed, "CAL2" and "enter" are blinking.</p> <p>Calibration with the first buffer is terminated. Remove the sensor from the first buffer solution and rinse it thoroughly.</p> | <p>Note: Stability check can be stopped after 10 sec (by pressing enter). However, this reduces calibration accuracy. Display for 1-point cal:</p> |
|  | <p>Use the arrow keys to select:</p> <ul style="list-style-type: none"> • END (1-point cal) • CAL2 (2-point cal) • REPEAT <p>Press enter to proceed.</p> |  <p>Sensoface is active. Exit by pressing enter</p> |
|  | <p>2-point calibration: Immerse sensor in second buffer solution. Press enter to start.</p> | <p>The calibration process runs as for the first buffer.</p> |
|  | <p>Retract sensor out of second buffer, rinse off, re-install. Press enter to proceed.</p> | <p>The slope and asymmetry potential of the sensor (based on 25 °C) are displayed.</p> |
|  | <p>Use the arrow keys to select:</p> <ul style="list-style-type: none"> • MEAS (exit) • REPEAT <p>Press enter to proceed. Exit: HOLD is deactivated with delay.</p> | <p>When 2-point cal is exited:</p>  |

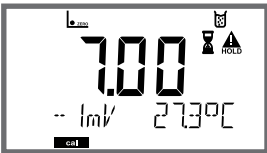
pH

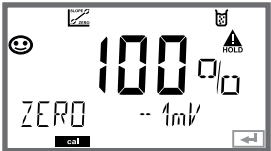

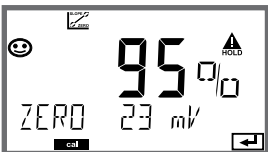
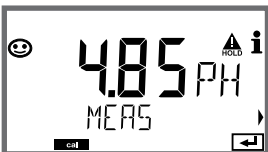

The MAN calibration mode and the type of temperature detection are selected during **configuration**. For calibration with manual buffer specification, you must enter the pH value of the buffer solution used in the device for the proper temperature. Any desired buffer solution can be used for calibration.

| Display | Action | Remark |
|---|--|--|
|  The display shows 'CAL' in large digits, 'CAL_PH' below it, and a 'HOLD' icon with a triangle. A 'cal' indicator is at the bottom left, and arrow keys are at the bottom. | Select Calibration. Press enter to proceed. | |
|  The display shows 'CAL' in large digits, 'BUFFER MANUAL' below it, and a 'HOLD' icon with a triangle. A 'cal' indicator is at the bottom left, and arrow keys are at the bottom. | Ready for calibration. Hourglass blinks. | Display (3 sec) Now the device is in HOLD mode. |
|  The display shows 'CAL M 1' in large digits, '702PH' and '274°C' below it, and a 'HOLD' icon with a triangle. A 'cal' indicator is at the bottom left, and arrow keys are at the bottom. | Remove the sensor and temperature probe, clean them, and immerse them in the first buffer solution. Press enter to start. | When manual input of temperature has been configured, the temp value in the display blinks and can be edited using the arrow keys. |
|  The display shows '07.00' in large digits, '1431' and '274°C' below it, and a 'HOLD' icon with a triangle. A 'cal' indicator is at the bottom left, and arrow keys are at the bottom. | Enter the pH value of your buffer solution for the proper temperature. While the "hourglass" icon is blinking, the sensor and temperature probe remain in the buffer solution. | The response time of the sensor and temperature probe is considerably reduced when the sensor is first moved about in the buffer solution and then held still. |
|  The display shows '7.00' in large digits, '-1mV' and '273°C' below it, and a 'HOLD' icon with a triangle. A 'cal' indicator is at the bottom left, and arrow keys are at the bottom. | | |

| Display | Action | Remark |
|---|--|---|
|  | <p>At the end of the stability check, the value will be saved and the asymmetry potential will be displayed. Calibration with the first buffer is terminated. Remove the sensor and temp probe from the first buffer solution and rinse them thoroughly.</p> <p>Use the arrow keys to select:</p> <ul style="list-style-type: none"> • END (1-point cal) • CAL2 (2-point cal) • REPEAT <p>Press enter to proceed.</p> | <p>Note: Stability check can be stopped after 10 sec (by pressing enter). However, this reduces calibration accuracy. Display for 1-point cal:</p>  <p>Sensoface is active. Exit by pressing enter</p> |
|  | <p>2-point calibration: Immerse sensor and temperature probe in the second buffer solution. Enter pH value. Press enter to start.</p> | <p>The calibration process runs as for the first buffer.</p> |
|  | <p>Rinse sensor and temperature probe and reinstall them. Press enter to proceed.</p> | <p>Display of slope and asymmetry potential of the sensor (based on 25 °C).</p> |
|  | <p>Use the arrow keys to select:</p> <ul style="list-style-type: none"> • MEAS (exit) • REPEAT <p>Press enter to proceed. Exit: HOLD is deactivated with delay.</p> | <p>When 2-point cal is exited:</p>  |

pH

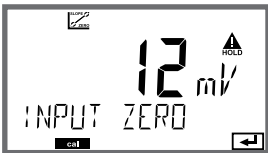
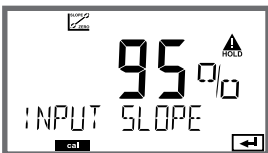
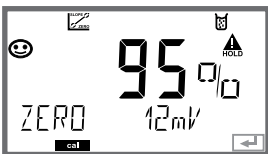
The DAT calibration mode must have been preset during configuration. You can directly enter the values for slope and asymmetry potential of a sensor. The values must be known, e.g., determined beforehand in the laboratory.

| Display | Action | Remark |
|--|---|---|
|  The display shows 'CAL' in large digits, 'CAL_PH' below it, and 'cal' at the bottom left. There are navigation arrows and a 'HOLD' indicator. | Select Calibration. Press enter to proceed. | |
|  The display shows 'CAL' in large digits, 'DATA INPUT' below it, and 'cal' at the bottom left. There are navigation arrows and a 'HOLD' indicator. | "Data Input" Ready for calibration. Hourglass blinks. | Display (3 sec) Now the device is in HOLD mode. |
|  The display shows '12 mV' in large digits, 'INPUT ZERO' below it, and 'cal' at the bottom left. There are navigation arrows and a 'HOLD' indicator. | Enter asymmetry potential [mV]. Press enter to proceed. | |
|  The display shows '95 %' in large digits, 'INPUT SLOPE' below it, and 'cal' at the bottom left. There are navigation arrows and a 'HOLD' indicator. | Enter slope [%]. | |
|  The display shows '95 %' in large digits, 'ZERO' and '12mV' below it, and 'cal' at the bottom left. There are navigation arrows and a 'HOLD' indicator. | The device displays the new slope and asymmetry poten- tial (at 25 °C). Sensoface is active. | |
|  The display shows '7.23 pH' in large digits, 'MEAS' below it, and 'cal' at the bottom left. There are navigation arrows and a 'HOLD' indicator. | Use the arrow keys to select: • MEAS (exit) • REPEAT Press enter to proceed. | Exit: HOLD is deactivated with delay. |

Converting slope [%] to slope [mV/pH] at 25 °C

| % | mV |
|------------|-------------|
| 78 | 46,2 |
| 80 | 47,4 |
| 82 | 48,5 |
| 84 | 49,7 |
| 86 | 50,9 |
| 88 | 52,1 |
| 90 | 53,3 |
| 92 | 54,5 |
| 94 | 55,6 |
| 96 | 56,8 |
| 98 | 58,0 |
| 100 | 59,2 |
| 102 | 60,4 |

Converting asymmetry potential to sensor zero point

$$\text{ZERO} = 7 - \frac{V_{AS} [\text{mV}]}{S [\text{mV}]}$$

ZERO = Sensor zero

V_{AS} = Asymmetry potential

S = Slope

pH

The potential of a redox sensor is calibrated using a **redox (ORP) buffer solution**. In the course of that, the difference between the measured potential and the potential of the calibration solution is determined according to the following equation. During measurement this difference is added to the measured potential.

$$mV_{\text{ORP}} = mV_{\text{meas}} - \Delta mV$$

mV_{ORP} = displayed ORP

mV_{meas} = direct sensor potential

ΔmV = delta value, determined during calibration

The sensor potential can also be related to another reference system – e.g., the standard hydrogen electrode. In that case the temperature-corrected potential (see table) of the reference electrode used must be entered during calibration. During measurement, this value is then added to the ORP measured. Please make sure that measurement and calibration temperature are the same since the temperature behavior of the reference electrode is not automatically taken into account.

Temperature dependence of reference systems measured against SHE

| Temperature [°C] | Ag/AgCl/KCl 1 mol/l [ΔmV] | Ag/AgCl/KCl 3 mol/l [ΔmV] | Thalamid [ΔmV] | Mercury sulfate [ΔmV] |
|---------------------|---------------------------------|---------------------------------|-------------------|--------------------------|
| 0 | 249 | 224 | -559 | 672 |
| 10 | 244 | 217 | -564 | 664 |
| 20 | 240 | 211 | -569 | 655 |
| 25 | 236 | 207 | -571 | 651 |
| 30 | 233 | 203 | -574 | 647 |
| 40 | 227 | 196 | -580 | 639 |
| 50 | 221 | 188 | -585 | 631 |
| 60 | 214 | 180 | -592 | 623 |
| 70 | 207 | 172 | -598 | 613 |
| 80 | 200 | 163 | -605 | 603 |

Calculating the rH (reference system: Ag/AgCl/KCl 3 mol/l)





$$rH = 2 \left(\frac{((\text{ORP} + E_{\text{REF}})/E_{\text{N}}) + \text{pH}}{2} \right)$$

ORP oxidation-reduction potential measured between the platinum electrode and the reference electrode

E_{REF} temperature-dependent potential of the reference electrode measured relative to SHE (standard hydrogen electrode)

E_{N} Nernst potential (temperature dependent)

pH currently measured pH value

| Display | Action | Remark |
|--|---|--|
|  <p>The display shows 'CAL' in large digits at the top. Below it, 'CAL_ORP' is displayed. There are navigation arrows on the left and right sides, and a 'CAL' label at the bottom left.</p> | <p>Select ORP calibration. Press enter to proceed.</p> | |
|  <p>The display shows 'CAL' in large digits at the top. Below it, 'ORP ADJUST' is displayed. There is a 'HOLD' icon and a 'CAL' label at the bottom left.</p> | <p>Remove the sensor and temperature probe, clean them, and immerse them in the redox buffer.</p> | <p>Display (3 sec) Now the device is in HOLD mode.</p> |
|  <p>The display shows '220' in large digits with 'mV' to the right. Below it, 'SOLUTION 275°C' is displayed. There is a 'HOLD' icon and a 'CAL' label at the bottom left.</p> | <p>Enter setpoint value for redox buffer. Press enter to proceed.</p> | |
|  <p>The display shows '213' in large digits with 'mV' to the right. Below it, 'ORP DELTA' is displayed. There is a smiley face icon on the left, a 'HOLD' icon on the right, and a 'CAL' label at the bottom left.</p> | <p>The ORP delta value is displayed (based on 25 °C). Sensoface is active. Press enter to proceed.</p> | |
|  <p>The display shows '223' in large digits with 'mV' to the right. Below it, 'MEAS' is displayed. There is a 'HOLD' icon and a 'CAL' label at the bottom left.</p> | <p>To repeat calibration: Select REPEAT. To exit calibration: Select MEAS, then enter</p> | <p>After end of calibration, the outputs remain in HOLD mode for a short time.</p> |



pH



Calibration by sampling (one-point calibration).
 During product calibration the sensor remains in the process.
 The measurement process is only interrupted briefly.

Procedure:

- 1) The sample is measured in the lab or directly on the site using a portable meter.
 To ensure an exact calibration, the sample temperature must correspond to the measured process temperature.
 During sampling the device saves the currently measured value and then returns to measuring mode. The "calibration" mode indicator blinks.
- 2) In the second step you enter the measured sample value in the device. From the difference between the stored measured value and entered sample value, the device calculates the new asymmetry potential.

If the sample is invalid, you can take over the value stored during sampling. In that case, the old calibration values are stored. Afterwards, you can start a new product calibration.

| Display | Action | Remark |
|--|---|--|
|  | Select product calibration: P_CAL Press enter to proceed. | If you have protected the calibration with a passcode (in the Service menu), the device will return to measuring mode when an invalid code is entered. |
|  | Ready for calibration. Hourglass blinks. Press enter to proceed. | Display (3 sec) |
|  | Take sample and save value. Press enter to proceed. | Now the sample can be measured in the lab. |

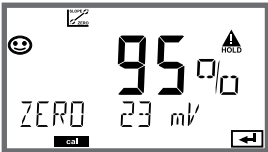
| Display | Action | Remark |
|--|---|---|
|  | The device returns to measuring mode. | From the blinking CAL mode indicator, you see that product calibration has not been terminated. |
|  | Product calibration step 2: When the sample value has been determined, open the product calibration once more (P_CAL). | Display (3 sec) Now the device is in HOLD mode. |
|  | The stored value is displayed (blinking) and can be overwritten with the measured sample value. Press enter to proceed. | |
|  | Display of new asymmetry potential (based on 25 °C). Sensoface is active. To exit calibration: Select MEAS, then enter | To repeat calibration: Select REPEAT, then enter |
| End of calibration | After end of calibration, the outputs remain in HOLD mode for a short time. | |

Display



or AM/PM and °F:

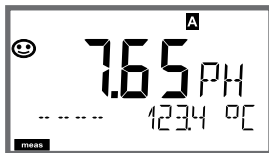
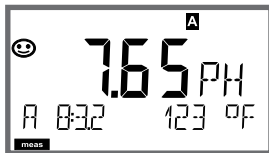

By pressing the **meas** key you can step through the different displays. When no key has been pressed for 60 sec, the device returns to MAIN DISPLAY.

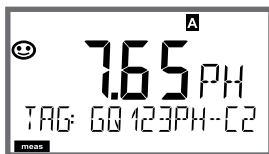

Remark

From the configuration or calibration menus, you can switch the device to measuring mode by pressing the **meas** key.

In the measuring mode the upper display line shows the configured process variable (pH, ORP [mV] or temperature), the lower display line shows the time and the second configured process variable (pH, ORP [mV] or temperature). The [meas] mode indicator lights and the active parameter set (A/B) is indicated.

Note:

- After prolonged power outage (> 5 days), the time display is replaced by dashes and cannot be used for processing. In that case, enter the correct time and the correct date.

1) Selecting the parameter set (if set to “manual” in the configuration).

Select the desired parameter set using the ◀ ▶ arrow keys (PARSET A or PARSET B blinks in the lower display line). Press **enter** to confirm.

Further displays
(each by pressing **meas**).

- 2) Display of tag number (“TAG”)
- 3) Display of time and date
- 4) Display of output currents

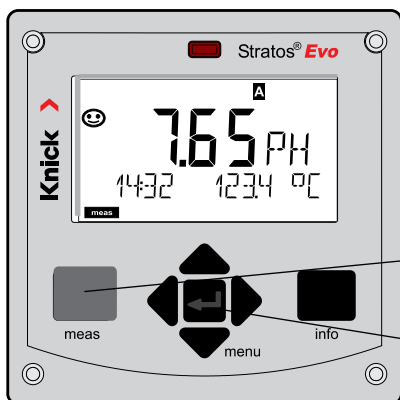

The MAIN DISPLAY is the display which is shown in measuring mode. To call the measuring mode from any other mode, hold the **meas** key depressed for at least 2 sec.

meas key

enter key



By pressing **meas** briefly you can step through further displays such as tag number (TAG) or flow (L/h).

These displays are turquoise. After 60 sec they switch back to the main display.

Press **enter** to select a display as MAIN DISPLAY.

The secondary display shows "MAIN DISPLAY – NO". Use the **UP / DOWN** arrows to select "MAIN DISPLAY – YES" and confirm by pressing **enter**.

The display color changes to white. This display is now shown in measuring mode.

The color-coded user interface guarantees increased operating safety. Operating modes are clearly signaled.

The normal measuring mode is white. Information text appears on a green screen and the diagnostic menu appears on turquoise. The orange HOLD mode (e.g., during calibration) is quickly visible as is the magenta screen which indicates asset management messages for predictive diagnostics – such as maintenance request, pre-alarm and sensor wear.

The alarm status has a particularly noticeable red display color and is also signaled by flashing display values. Invalid inputs or false passcodes cause the entire display to blink red so that operating errors are significantly reduced.

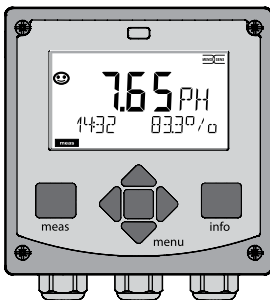

White:
Measuring mode

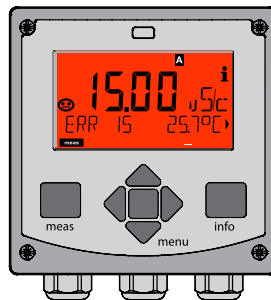

Red blinking:
Alarm, error

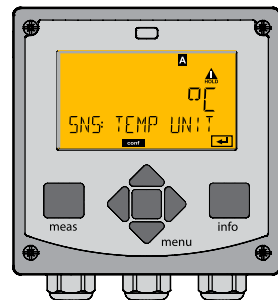

Orange:
HOLD mode

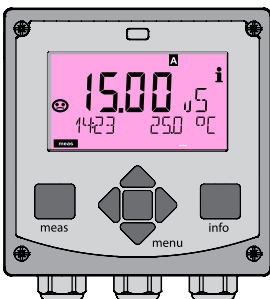

Magenta:
Maintenance request

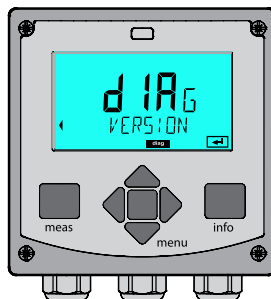

Turquoise:
Diagnostics

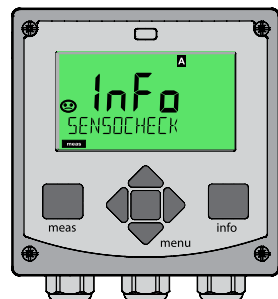

Green:
Info texts

Display**Remark****With activated controller**

you can also step through the following displays by pressing the **meas** key. When no key has been pressed for 60 sec, the device returns to the standard display.

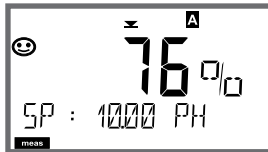

Upper display: Controller output Y

The controller output can be modified using ▲ ▼ .

This allows control systems to be tested and, above all, started smoothly.

Lower display: Setpoint

Depending on configuration setting:

pH, mV, or temperature.

In the Diagnostics mode you can access the following menus without interrupting the measurement:

| | |
|----------|---|
| CALDATA | Viewing the calibration data |
| SENSOR | Viewing the sensor data |
| SELFTEST | Starting a device self-test |
| LOGBOOK | Viewing the logbook entries |
| MONITOR | Displaying currently measured values |
| VERSION | Displaying device type, software version, serial number |

Access to diagnostics can be protected with a passcode (SERVICE menu).

Note:

HOLD is not active during Diagnostics mode!

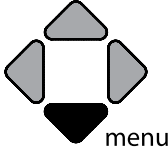
| Action | Key | Remark |
|---------------------------|---|---|
| Activate diagnostics |  | Press menu key to call the selection menu. (Display color changes to turquoise.) Select DIAG using ◀ ▶ keys, confirm by pressing enter |
| Select diagnostics option | | Use ◀ ▶ keys to select from: CALDATA SENSOR SELFTEST LOGBOOK MONITOR VERSION See next pages for further proceeding. |
| Exit | meas | Exit by pressing meas . |

Display

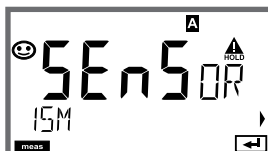

Menu item

Displaying the calibration data

(Example: pH)

Select CALDATA using ◀ ▶, confirm by pressing **enter**.

Use the ◀ ▶ keys to select the desired parameter from the bottom line of the display:

The selected parameter is shown in the upper display line.

Press **meas** to return to measurement.

Displaying the sensor data

For analog sensors, the type is displayed (STANDARD / ISFET). Cannot be operated with digital transmitters.

For digital sensors, the manufacturer, type, serial number and last calibration date are displayed.

In each case Sensoface is active.

Display data using ◀ ▶ keys, return by pressing **enter** or **meas**.

Display

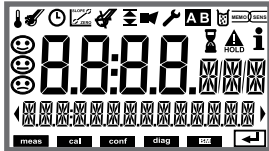

Menu item

Device self-test

(To abort, you can press **meas**.)

- 1) **Display test:** Display of all segments with changing background colors (white/green/red). Proceed by pressing **enter**
- 2) **RAM test:** Hourglass blinks, then display of --PASS-- or --FAIL-- Proceed by pressing **enter**
- 3) **EEPROM test:** Hourglass blinks, then display of --PASS-- or --FAIL-- Proceed by pressing **enter**
- 4) **FLASH test:** Hourglass blinks, then display of --PASS-- or --FAIL-- Proceed by pressing **enter**
- 5) **Module test:** Hourglass blinks, then display of --PASS-- or --FAIL-- Return to measuring mode by pressing **enter** or **meas**

Display



Menu item

Displaying the logbook entries

Select LOGBOOK using ◀ ▶ , press **enter** to confirm.

With the ▲ ▼ keys, you can scroll backwards and forwards through the logbook (entries -00-...-99-), -00- being the last entry.

If the display is set to date/time, you can search for a particular date using the ▲ ▼ keys.

Press ◀ ▶ to view the corresponding message text.

If the display is set to the message text, you can search for a particular message using the ▲ ▼ keys.

Press ◀ ▶ to display the date and time.

Press **meas** to return to measurement.

Extended logbook / Audit Trail (via TAN)

With the ▲ ▼ keys, you can scroll backwards and forwards through the extended logbook (entries -000-...-99-), -000- being the last entry.

Display: CFR

Audit Trail also records function activations (CAL CONFIG SERVICE), some Sensoface messages (cal timer, wear), and opening of the enclosure.

Display



Display examples:



Menu item

Displaying the currently measured values (sensor monitor – example: pH)

Select MONITOR using ◀ ▶, press **enter** to confirm. Use the ◀ ▶ keys to select the desired parameter from the bottom line of the display: mV_PH mV_ORP RTD R_GLASS R_REF I-INPUT (for digital sensors also: OPERATION TIME SENSOR WEAR LIFETIME CIP SIP AUTOCLAVE, for ISM sensors in addition: ACT (adaptive cal timer), TTM (adaptive maintenance timer), DLI (Dynamic Life Time Indicator)). The selected parameter is shown in the upper display line. Press **meas** to return to measurement.

Display of mV_pH
(for validation, sensor can be immersed in a calibration solution, for example, or the device is checked by using a simulator)

Display of remaining dynamic lifetime
(only for digital sensors, however not for MEMOSENS)

Display of sensor operating time
(for digital sensors only)

Version

Display of **device type, software/hardware/ boot-loader version** and **serial number** for all device components.



Use the ▲ ▼ keys to switch between software and hardware version. Press **enter** to proceed to next device component.



In the Service mode you can access the following menus:

| | |
|-------------|--|
| MONITOR | Displaying currently measured values |
| SENSOR | Displaying the sensor data; ISM only: resetting TTM; ISM, Memosens, InduCon: incrementing the autoclaving counter |
| POWER OUT | Power output (adjustable: 3.1/12/15/24 V) |
| OUT1 | Testing current output 1 |
| OUT2 | testing current output 2 |
| RELAIS | Testing the function of the 4 relays |
| CONTROL | Testing the controller function |
| CODES | Assigning and editing passcodes |
| DEVICE TYPE | Selecting the measuring function |
| DEFAULT | Resetting the device to factory settings |
| OPTION | enabling options via TAN |

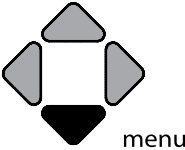

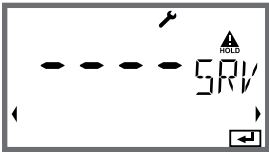

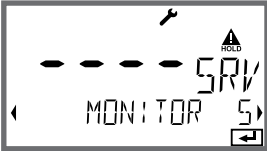
Note:

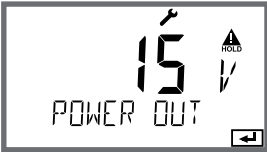
HOLD is active during Service mode!

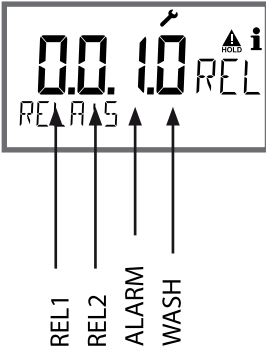
| Action | Key/Display | Remark |
|------------------|---|--|
| Activate Service |  | Press menu key to call the selection menu. Select SERVICE using ◀ ▶ keys, press enter to confirm. |
| Passcode |  | Enter passcode "5555" for service mode using the ▲ ▼ ◀ ▶ keys. Press enter to confirm. |
| Display |  | In service mode the following icons are displayed: <ul style="list-style-type: none"> • HOLD triangle • Service (wrench) |
| Exit | meas | Exit by pressing meas . |

| Menu item | Remark |
|---|--|
|  | <p>Displaying currently measured values (sensor monitor) with HOLD mode activated:</p> <p>Select MONITOR using ◀ ▶, press enter to confirm. Select variable in the bottom text line using ◀ ▶. The selected parameter is shown in the upper display line.</p> <p>As the device is in HOLD mode, you can perform validations using simulators without influencing the signal outputs.</p> <p>Hold meas depressed for longer than 2 sec to return to Service menu.</p> <p>Press meas once more to return to measurement.</p> |
| <p>SENSOR / TTM</p>  | <p>Resetting the adaptive maintenance timer</p> <p>Here, the interval is reset to its initial value. To do so, select "TTM RESET = YES" and confirm by pressing enter.</p> |
| <p>SENSOR / AUTOCLAVE</p>  | <p>Incrementing the autoclaving counter</p> <p>After having completed an autoclaving process, you must increment the autoclaving count. To do so, select "YES" and confirm by pressing enter. The device confirms with "INCREMENT AUTOCLAVE CYCLE".</p> |
| <p>POWER OUT</p>  | <p>POWER OUT, adjusting the output voltage</p> <p>Here, you can select an output voltage of 3.1/12/15/24 V. When the SE 740 optical oxygen sensor has been selected, the output voltage will be automatically set to 15 V, regardless of the setting in the SERVICE menu.</p> |





| Menu item | Remark |
|---|--|
|  <p>The screenshot shows a digital display with '12.2 mA' in the center. Below it, 'OUT 1' is on the left and '12.2 mA' is on the right. There are also some icons like a triangle with 'i' and a square with a left arrow.</p> | <p>Specifying the current for outputs 1 and 2: Select OUT1 or OUT2 using the ◀ ▶ keys, press enter to confirm. Enter a valid current value for the respective output using ▲ ▼ ◀ ▶ keys. Confirm by pressing enter. For checking purposes, the actual output current is shown in the bottom right corner of the display. Exit by pressing enter or meas.</p> |
|  <p>The screenshot shows a digital display with '0.0. 1.0 REL' in the center. Below the display, there are four labels: 'REL1', 'REL2', 'ALARM', and 'WASH'. Arrows point from each label to a specific digit in the display: REL1 to the first '0', REL2 to the second '0', ALARM to the first '1', and WASH to the second '1'.</p> | <p>Relay test (manual test of contacts): Select RELAIS using ◀ ▶, press enter to confirm. Now the status of the 4 relays is "frozen". The 4 digits of the main display represent the respective states (from left to right: REL1, REL2, ALARM, WASH). The digit for the selected relay blinks. Select one of the 4 relays using the ◀ ▶ keys, close (1) or open (0) using the ▲ ▼ keys. Exit by pressing enter. The relays will be re-set corresponding to the measured value. Press meas to return to measurement.</p> |



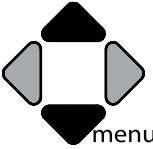

| Menu item | Remark |
|--|---|
|  | <p>Assigning passcodes: In the "SERVICE - CODES" menu you can assign passcodes to DIAG, HOLD, CAL, CONF and SERVICE modes (Service preset to 5555).</p> <p>When you have lost the Service passcode, you have to request an "Ambulance TAN" from the manufacturer specifying the serial number and hardware version of your device. To enter the "Ambulance TAN", call the Service function and enter passcode 7321. After correct input of the ambulance TAN the device signals "PASS" for 4 sec and resets the Service passcode to 5555.</p> |
|  | <p>Reset to factory settings: In the "SERVICE - DEFAULT" menu you can reset the device to factory settings.</p> <p>NOTICE! After a reset to factory setting the device must be reconfigured completely, including the sensor parameters!</p> |
|  | <p>Option request: Communicate the serial number and hardware/software version of your device to the manufacturer. These data can be viewed in the Diagnostics/Version menu. The "transaction number" (TAN) you will then receive is only valid for the device with the corresponding serial number.</p> <p>Releasing an option: Options come with a "transaction number" (TAN). To release the option, enter this TAN and confirm by pressing enter.</p> |
|  | <p>Device type: Changing the measuring function, e.g., after having replaced a Memosens sensor. Not possible with a measuring module installed.</p> |

Power Disruption while Loading the Process Variable

In very rare cases it seems that the analyzer cannot be operated because it remains in “Firmware Update” mode – indicated by the --FIRMW UPDATE-- message. This occurs when the power is disrupted while the process variable is loaded. Follow the instructions below to fix the error.



| Action | Key/Display | Remark |
|--------------------------------|---|---|
| Device start |  | If the power supply is disrupted while the process variable is loaded (e.g., during initial start-up or when changing the process variable), the following can occur: |
| Reconnecting the power supply |  | After the power supply has been reconnected, the analyzer starts and then remains in --FIRMW UPDATE-- mode. If this occurs, disconnect the power supply. |
| Restoring the factory settings |  | Press the ▲ ▼ keys simultaneously and hold them depressed while the analyzer is reconnected to the power supply. |
| Device start |  | Release the keys when the display shows LOADING BASE. The analyzer will restart with the BASE software when 100 % is reached. |

| Action | Key/Display | Remark |
|---|--|---|
| Searching for the process variable |  | Then the analyzer searches for a measuring module or Memosens sensor. |
| Loading the process variable, automatic |  | When a module or a sensor has been found, the loading progress is shown in percentages. |
| Loading the process variable, manual |  | If neither module nor sensor are found, the display shows DEVICE TYPE. The selected process variable blinks. You can modify it using the \blacktriangle \blacktriangledown keys. Press enter to load the process variable displayed. |
| Loading ... |  | Make sure that the power supply is not interrupted before the process variable is fully loaded (100%) . |

| Error | Info text (is displayed in case of fault when the Info key is pressed) | Problem Possible causes |
|---------------|--|--|
| ERR 01 | NO SENSOR | Sensor error Device type not assigned Defective sensor Sensor not connected Break in sensor cable |
| ERR 02 | WRONG SENSOR | Wrong sensor |
| ERR 04 | SENSOR FAILURE | Failure in sensor |
| ERR 05 | CAL DATA | Error in cal data |
| ERR 10 | ORP RANGE | Display range violation ORP: < -1999 mV or > 1999 mV |
| ERR 11 | RANGE | Display range violation |
| ERR 12 | MV RANGE | mV range |
| ERR 13 | TEMPERATURE RANGE | Temperature range violation (See "Measuring range" on page 160) |
| ERR 14 | rH RANGE | Range error (rH) |
| ERR 15 | SENSOCHECK GLASS-EL | Glass Sensocheck (pH) |
| ERR 60 | OUTPUT LOAD | Load error |
| ERR 61 | OUTPUT 1 TOO LOW | Output current 1 < 0 (3.8) mA |
| ERR 62 | OUTPUT 1 TOO HIGH | Output current 1 > 20.5 mA |
| ERR 63 | OUTPUT 2 TOO LOW | Output current 2 < 0 (3.8) mA |
| ERR 64 | OUTPUT 2 TOO HIGH | Output current 2 > 20.5 mA |

| Error | Info text (is displayed in case of fault when the Info key is pressed) | Problem Possible causes |
|----------------|--|--|
| ERR 95 | SYSTEM ERROR | System error Restart required. If error still persists, send in the device for repair. |
| ERR 97 | WRONG MODULE | Module does not correspond to measuring function Correct the setting in the SERVICE / DEVICE TYPE menu. Afterwards, configure and calibrate the device. |
| ERR 98 | CONFIGURATION ERROR | Error in configuration or calibration data Configuration or calibration data defective; completely reconfigure and recalibrate the device. |
| ERR 99 | DEVICE FAILURE | Error in factory settings EEPROM or RAM defective This error message only occurs in the case of a total defect. The device must be repaired and recalibrated at the factory. |
| ERR 100 | INVALID SPAN OUT1 | Span Out1 configuration error Selected span too small |
| ERR 101 | INVALID SPAN OUT2 | Span Out2 configuration error Selected span too small |

| Error | Info text (is displayed in case of fault when the Info key is pressed) | Problem Possible causes |
|----------------|--|--|
| ERR 102 | pH: FAILURE BUFFERSET -U1- | Parameter error Specifiable buffer set U1 |
| | Multichannel operation: MSPH/MSPH, MSPH/MSOXY: A FAILURE BUFFERSET -U1- | Parameter error Specifiable buffer set U1, sensor A |
| ERR 104 | INVALID PARAMETER CONTROLLER | Parameter error Controller |
| ERR 105 | INVALID SPAN I-INPUT | Parameter error Current input |
| ERR 106 | INVALID CHANNEL SELECTION OUT1/2 | Multichannel operation: MSPH/MSPH, MSPH/MSOXY: Currents not assigned |
| ERR 107 | INVALID CHANNEL SELECTION RELAYS | Multichannel operation: MSPH/MSPH, MSPH/MSOXY: Limit values not assigned |
| ERR 108 | Multichannel operation: MSPH/MSPH, MSPH/MSOXY: INVALID CHANNEL SELECTION CONTROL | Controller not assigned |

Sensoface messages:

| | |
|---|---|
| Calibration timer expired: | OUT OF CAL TIME CALIBRATE OR CHANGE SENSOR |
| TTM for ISM (pH): | OUT OF MAINTENANCE CLEAN SENSOR |
| TTM for ISM (Oxy): | OUT OF MAINTENANCE CHECK ELECTROLYTE AND MEMBRANE |
| DLI for ISM: | END OF LIFETIME CHANGE SENSOR OR INNERBODY |
| ISFET sensor offset: | SENSOR ISFET-ZERO CALIBRATE OR CHANGE SENSOR |
| Sensor zero/slope: | SENSOR ZERO/SLOPE CALIBRATE OR CHANGE SENSOR |
| Sensor response: | SENSOR DRIFT CALIBRATE OR CHANGE SENSOR |
| Sensor wear (pH): | SENSOR WEAR CHANGE SENSOR |
| Sensor wear (Oxy MS): | SENSOR WEAR CHECK ELECTROLYTE AND MEMBRANE |
| Sensor wear (LDO, SE 740): | SENSOR WEAR CHANGE SENSOR CAP |
| Autoclaving counter: | AUTOCLAVE CYCLES OVERRUN |
| CIP cycles exceeded: | CIP-CYCLES OVERRUN |
| SIP cycles exceeded: | SIP-CYCLES OVERRUN |
| Sensor TAG does not correspond to device entry. | WRONG SENSOR TAG |
| Sensor GROUP does not correspond to device entry. | WRONG SENSOR GROUP xxxx |

Sensocheck, Sensoface Sensor Monitoring



Sensocheck continuously monitors the sensor and its wiring. The three Sensoface indicators provide information on required maintenance of the sensor. Additional icons refer to the error cause. Pressing the **info** key shows an information text.

Note:

The worsening of a Sensoface criterion leads to the devaluation of the Sensoface indicator (Smiley gets “sad”). An improvement of the Sensoface indicator can only take place after calibration or removal of the sensor defect.

Sensoface message





























The Sensocheck message is also output as error message Err 15. The alarm contact is active, the display backlighting turns red (when configured correspondingly). Sensoface can be output as a 22-mA signal via the current outputs.

Disabling Sensocheck and Sensoface

Sensocheck can be switched off in the configuration menu (then Sensoface is also disabled).

Exception:

After a calibration, a smiley is always displayed for confirmation.

| Operating status | OUT 1 | OUT 2 | REL1/2 | Alarm | Time out |
|---|---|---|--|--|----------|
| Measure |  |  |  |  | - |
| DIAG |  |  |  |  | 60 s |
| HOLD |  |  | | | No |
| CAL |  |  | | | No |
| CONF |  |  | | | 20 min |
| SERVICE |  |  | | | 20 min |
| SERVICE OUT 1 |  |  | | | 20 min |
| SERVICE OUT 2 |  |  | | | 20 min |
| SERVICE RELAIS |  |  |  |  | 20 min |
| SERVICE (CODES, DEVICE TYPE; OPTION) |  |  | | | 20 min |
| Cleaning function |  |  | | | No |

Explanation:



as configured (Last/Fix or Last/Off)



active



manual

Devices (basic digital devices)

| | Order No. |
|--|------------------|
| Stratos Evo A402N | A402N |
| Stratos Evo A402B (operation in hazardous locations, Zone 2) | A402B |

Interchangeable modules for measurement with analog sensors or 2nd Memosens channel

| | |
|----------------------|--------------|
| pH | MK-PH015N |
| Oxy | MK-OXY045N |
| Cond | MK-COND025N |
| Condl | MK-CONDI035N |
| Cond-Cond | MK-CC065N |
| 2nd Memosens channel | MK-MS095N |

Interchangeable modules for measurement with analog sensors, hazardous area Zone 2

| | |
|------------------------------|--------------|
| pH, hazardous area Zone 2 | MK-PH015X |
| Oxy, hazardous area Zone 2 | MK-OXY045X |
| Cond, hazardous area Zone 2 | MK-COND025X |
| Condl, hazardous area Zone 2 | MK-CONDI035X |

TAN options

| | |
|-------------------------------|---------|
| HART | SW-A001 |
| Logbook | SW-A002 |
| Extended logbook (AuditTrail) | SW-A003 |
| Oxygen trace measurement | SW-A004 |
| Current input | SW-A005 |
| ISM digital | SW-A006 |
| Pfautler | SW-A007 |

Mounting accessories

Pipe-mount kit

Panel-mount kit

Protective hood

M12 socket for sensor connection
with Memosens cable / M12 connector**Order No.**

ZU 0274

ZU 0738

ZU 0737

ZU 0860

Up-to-date information:www.knick.de

Phone: +49 30 80191-0

Fax: +49 30 80191-200

Email: knick@knick.de

pH

| | | | |
|--|-------------------------|---------------------------------------|----------------|
| Display range (depending on sensor) | pH value | -2.00 ... 16.00 | |
| | ORP | -1999 ... 1999 mV | |
| | Temperature | -20.0 ... +200.0 °C (-4 ... + 392 °F) | |
| | rH value (combo sensor) | 000.0 ... 200.0 rH | |
| Measurement error ¹⁾ | pH value | < 0.02 | TC: 0.002 pH/K |
| | mV value | < 1 mV | TC: 0.1 mV/K |

pH sensor standardization *

| | | |
|-------------------------|---|---|
| | pH calibration | |
| Operating modes | AUTO | Calibration with Calimatic automatic buffer recognition |
| | MAN | Manual calibration with entry of individual buffer values |
| | DAT | Data entry of pre-measured electrodes |
| | Product calibration | |
| Calimatic buffer sets * | -01- Mettler-Toledo | 2.00/4.01/7.00/9.21 |
| | -02- Knick CaliMat | 2.00/4.00/7.00/9.00/12.00 |
| | -03- Ciba (94) | 2.06/4.00/7.00/10.00 |
| | -04- NIST technical | 1.68/4.00/7.00/10.01/12.46 |
| | -05- NIST standard | 1.679/4.006/6.865/9.180 |
| | -06- HACH | 4.01/7.00/10.01 |
| | -07- WTW techn. buffers | 2.00/4.01/7.00/10.00 |
| | -08- Hamilton | 4.01/7.00/10.01/12.00 |
| | -09- Reagecon | 2.00/4.00/7.00/9.00/12.00 |
| | -10- DIN 19267 | 1.09/4.65/6.79/9.23/12.75 |
| | -U1- | Specifiable buffer set with 2 buffer solutions |
| Max. calibration range | Asymmetry potential | ±60 mV (±750 mV for Memosens ISFET) |
| | Slope | 80 ... 103 % (47.5 ... 61 mV/pH) |
| | (possibly restricting notes from Sensoface) | |

ORP sensor standardization *

| | | |
|------------------------|--|--|
| | ORP calibration (zero adjustment) | |
| Max. calibration range | -700 ... +700 ΔmV | |
| Calibration timer | Interval 0000 ... 9999 h (Patent DE 101 41 408) | |
| Sensocheck | Automatic monitoring of glass electrode | |
| Delay | Approx. 30 s | |
| Sensoface | Provides information on the sensor condition (can be switched off) Evaluation of zero/slope, calibration interval, Sensocheck | |

^{*)} user-defined

¹⁾ according to IEC 746 Part 1, at normal operating conditions

pH

| | | |
|---------------------------------|---|---------------------------------------|
| TC of process medium | Linear -19.99 ... +19.99 %/K, ultrapure water | |
| Reference temperature | 25 °C | |
| Temperature input | Pt100 / Pt1000 / NTC / Balco * 2-wire connection, adjustable | |
| Measuring range | Pt100/Pt1000 | -20.0 ... +200.0 °C / -4 ... +392 °F |
| | NTC 30 kΩ | -20.0 ... +150.0 °C / -4 ... +302 °F |
| | NTC 8.55 kΩ (Mitsubishi) | -10.0 ... +130.0 °C / +14 ... +266 °F |
| | Balco 3 kΩ | -20.0 ... +130.0 °C / -4 ... +266 °F |
| Adjustment range | 10 K | |
| Resolution | 0.1 °C / 0.1 °F | |
| Measurement error ¹⁾ | < 0.5 K (± 1 K for Pt100; < 1 K for NTC > 100°C) | |
| MK-PH015... module | | |
| ISM input | "One wire" interface for operation with ISM (digital sensors) (6 V / Ri= approx. 1.2 kΩ) | |
| Power output | for operating an ISFET adapter | |
| | +3 V / 0.5 mA | |
| | -3 V / 0.5 mA | |

| | | | |
|---------------------------------|--|-------------------|-----------------|
| Input | for Memosens or optical sensors (SE 740) | | |
| Data In/Out | Asynchronous interface, RS-485, 9600/19200 Bd | | |
| Power supply | Terminal 1: +3.08 V/10 mA, Ri < 1 ohm, short-circuit-proof Terminal 5: 3.1 ... 24 V/1W in four discrete levels (3.1/12/15/24 V), short-circuit-proof (levels are software-selectable), 15 V automatic with SE 740 sensor selected | | |
| I input (TAN) | 4 ... 20 mA / 50 ohms | | |
| Function | Input of pressure or temperature values from external sensors | | |
| Resolution | Approx. 0.05 mA | | |
| Measurement error ¹⁾ | < 1% current value + 0.1 mA | | |
| Door contact | outputs a signal when the door is open Logbook entry (FDA) | | |
| HOLD input | Galvanically separated (optocoupler) | | |
| Function | Switches device to HOLD mode | | |
| Switching voltage | 0 ... 2 V AC/DC | HOLD inactive | |
| | 10 ... 30 V AC/DC | HOLD active | |
| CONTROL input * | Galvanically separated (optocoupler) | | |
| Function | Selecting parameter set A/B or flow measurement (FLOW) | | |
| Parameter set A/B | Control input | 0 ... 2 V AC/DC | Parameter set A |
| | | 10 ... 30 V AC/DC | Parameter set B |
| FLOW | Pulse input for flow measurement 0 ... 100 pulses/s | | |
| | Display: | 00.0 ... 99.9 l/h | |
| Output 1 | 0/4 ... 20 mA, max. 10 V, floating (terminals 8 / 9, galvanically connected to output 2) | | |
| Overrange * | 22 mA in the case of error messages | | |
| Characteristic | Linear, with conductivity measurement also bilinear or logarithmic | | |
| Output filter * | PT ₁ filter, time constant 0 ... 120 s | | |
| Measurement error ¹⁾ | < 0.25% current value + 0.025 mA | | |
| Output 2 | 0/4 ... 20 mA, max. 10 V, floating (terminals 9 / 10, galvanically connected to output 1) | | |
| Overrange * | 22 mA in the case of error messages | | |
| Characteristic | Linear, with conductivity measurement also bilinear or logarithmic | | |
| Output filter * | PT ₁ filter, time constant 0 ... 120 s | | |
| Measurement error ¹⁾ | < 0.25% current value + 0.025 mA | | |

^{*)} user-defined

¹⁾ according to IEC 746 Part 1, at normal operating conditions

| | |
|------------------------------|---|
| Power Out | |
| Power supply | Power supply output for operating optical sensors (SE 740), selectable between 3.1 V / 12 V / 15 V / 24 V, short-circuit-proof (for SE 740 fixed to 15 V), max. power 1 W |
| Alarm contact | Relay contact, floating |
| Contact ratings | AC < 250 V / < 3 A / < 750 VA DC < 30 V / < 3 A / < 90 W |
| Contact response * | N/C (fail-safe type) |
| Wash contact | Relay contact, floating |
| Contact ratings | AC < 250 V / < 3 A / < 750 VA DC < 30 V / < 3 A / < 90 W |
| Contact response * | N/C or N/O |
| Min/max limits | Min/max contacts, floating, but inter-connected |
| Contact ratings | AC < 250 V / < 3 A / < 750 VA DC < 30 V / < 3 A / < 90 W |
| Contact response * | N/C or N/O |
| Response delay * | 0000 ... 9999 s |
| Setpoints * | As desired within range |
| Hysteresis * | User-defined |
| Real-time clock | Different time and date formats selectable |
| Power reserve | > 5 days |
| Display | LC display, 7-segment with icons, colored backlighting |
| Primary display | Character height approx. 22 mm, unit symbols approx. 14 mm |
| Secondary display | Character height approx. 10 mm |
| Text line | 14 characters, 14 segments |
| Sensoface | 3 status indicators (friendly, neutral, sad face); provides information on the sensor condition. Evaluation of zero/slope, response, calibration interval, wear, Sensocheck (can be disabled), sensor verification (TAG, GROUP) |
| Mode indicators | meas, cal, conf, diag Further icons for configuration and messages |
| Alarm indication | Display blinks, red backlighting |
| Keypad | Keys: meas, info, 4 cursor keys, enter |
| 2 parameter sets | Parameter set A and B, switchover via CONTROL input or manually |
| Diagnostics functions | |
| Calibration data | Calibration date, zero, slope |
| Device self-test | Automatic memory test (RAM, FLASH, EEPROM) |
| Display test | Display of all segments |
| Logbook | 100 events with date and time 200 entries (Audit Trail) with extended logbook (TAN) |

*) user-defined

1) according to IEC 746 Part 1, at normal operating conditions

Service functions

| | |
|----------------|--|
| Current source | Current specifiable for output 1 and 2 (00.00 ... 22.00 mA) |
| Sensor monitor | Display of direct sensor signals (mV/temperature/operating time) |
| Relay test | Manual control of relay contacts |
| Device type | Selecting the measuring function |

Data retention Parameters, calibration data, logbook > 10 years (EEPROM)

Electrical safety Protection against electric shock by protective separation of all extra-low-voltage circuits against mains according to EN 61010-1

Explosion protection (A402B) see Control Drawing or www.knick.de

EMC EN 61326

Emitted interference Class B (residential environment)

Immunity to interference Industrial environment

RoHS conformity according to EC directive 2002/95/EC

Power supply 80 V (-15%) ... 230 (+10%) V AC ; ≤ 15 VA ; 45 ... 65 Hz
24 V (-15%) ... 60 (+10%) V DC ; 10 W
Overvoltage category II, protection class II

Nominal operating conditions

Ambient temperature -20 ... +55 °C / -4 ... +131 °F

Transport/Storage temperature -30 ... +70 °C / -22 ... +158 °F

Relative humidity 10 ... 95% not condensing

Enclosure Molded enclosure made of PBT/PC, glass fiber reinforced

Mounting Wall, pipe/post or panel mounting

Color Gray, RAL 7001

Ingress protection IP 67 / NEMA 4X outdoor (with pressure compensation)

Flammability UL 94 V-0

Dimensions H 148 mm, W 148 mm, D 117 mm

Control panel cutout 138 mm x 138 mm to DIN 43 700

Weight 1.2 kg (1.6 kg incl. accessories and packaging)

Cable glands 3 knockouts for M20 x 1.5 cable glands
2 knockouts for NPT 1/2" or rigid metallic conduit

Connections Terminals, conductor cross section max. 2.5 mm²

^{*)} user-defined

¹⁾ according to IEC 746 Part 1, at normal operating conditions

| | |
|---------------------------|---|
| HART communication | Digital communication via FSK modulation of output current ¹⁾ Device identification, measured values, status and messages, parameter setting, calibration, records |
| Conditions | Output current ≥ 3.8 mA and load resistance ≥ 250 ohms |

^{*)} user-defined

¹⁾ according to IEC 746 Part 1, at normal operating conditions

-01- Mettler-Toledo
(corresponds to former "Knick technical buffers")

| °C | pH | | | |
|-----------|-------------|-------------|-------------|-------------|
| 0 | 2.03 | 4.01 | 7.12 | 9.52 |
| 5 | 2.02 | 4.01 | 7.09 | 9.45 |
| 10 | 2.01 | 4.00 | 7.06 | 9.38 |
| 15 | 2.00 | 4.00 | 7.04 | 9.32 |
| 20 | 2.00 | 4.00 | 7.02 | 9.26 |
| 25 | 2.00 | 4.01 | 7.00 | 9.21 |
| 30 | 1.99 | 4.01 | 6.99 | 9.16 |
| 35 | 1.99 | 4.02 | 6.98 | 9.11 |
| 40 | 1.98 | 4.03 | 6.97 | 9.06 |
| 45 | 1.98 | 4.04 | 6.97 | 9.03 |
| 50 | 1.98 | 4.06 | 6.97 | 8.99 |
| 55 | 1.98 | 4.08 | 6.98 | 8.96 |
| 60 | 1.98 | 4.10 | 6.98 | 8.93 |
| 65 | 1.99 | 4.13 | 6.99 | 8.90 |
| 70 | 1.99 | 4.16 | 7.00 | 8.88 |
| 75 | 2.00 | 4.19 | 7.02 | 8.85 |
| 80 | 2.00 | 4.22 | 7.04 | 8.83 |
| 85 | 2.00 | 4.26 | 7.06 | 8.81 |
| 90 | 2.00 | 4.30 | 7.09 | 8.79 |
| 95 | 2.00 | 4.35 | 7.12 | 8.77 |

pH

-02- Knick CaliMat
(Values also apply to Merck-Titrisols, Riedel-de-Haen Fixanals.)

| °C | pH | | | | |
|-----------|---------------|---------------|---------------|---------------|---------------|
| Order No. | CS-P0200A/... | CS-P0400A/... | CS-P0700A/... | CS-P0900A/... | CS-P1200A/... |
| 0 | 2.01 | 4.05 | 7.09 | 9.24 | 12.58 |
| 5 | 2.01 | 4.04 | 7.07 | 9.16 | 12.39 |
| 10 | 2.01 | 4.02 | 7.04 | 9.11 | 12.26 |
| 15 | 2.00 | 4.01 | 7.02 | 9.05 | 12.13 |
| 20 | 2.00 | 4.00 | 7.00 | 9.00 | 12.00 |
| 25 | 2.00 | 4.01 | 6.99 | 8.95 | 11.87 |
| 30 | 2.00 | 4.01 | 6.98 | 8.91 | 11.75 |
| 35 | 2.00 | 4.01 | 6.96 | 8.88 | 11.64 |
| 40 | 2.00 | 4.01 | 6.96 | 8.85 | 11.53 |
| 50 | 2.00 | 4.01 | 6.96 | 8.79 | 11.31 |
| 60 | 2.00 | 4.00 | 6.96 | 8.73 | 11.09 |
| 70 | 2.00 | 4.00 | 6.96 | 8.70 | 10.88 |
| 80 | 2.00 | 4.00 | 6.98 | 8.66 | 10.68 |
| 90 | 2.00 | 4.00 | 7.00 | 8.64 | 10.48 |

-03- Ciba (94) buffers
Nominal values: 2.06 4.00 7.00 10.00

| °C | pH | | | |
|----|-------|-------|-------|-------|
| 0 | 2.04 | 4.00 | 7.10 | 10.30 |
| 5 | 2.09 | 4.02 | 7.08 | 10.21 |
| 10 | 2.07 | 4.00 | 7.05 | 10.14 |
| 15 | 2.08 | 4.00 | 7.02 | 10.06 |
| 20 | 2.09 | 4.01 | 6.98 | 9.99 |
| 25 | 2.08 | 4.02 | 6.98 | 9.95 |
| 30 | 2.06 | 4.00 | 6.96 | 9.89 |
| 35 | 2.06 | 4.01 | 6.95 | 9.85 |
| 40 | 2.07 | 4.02 | 6.94 | 9.81 |
| 45 | 2.06 | 4.03 | 6.93 | 9.77 |
| 50 | 2.06 | 4.04 | 6.93 | 9.73 |
| 55 | 2.05 | 4.05 | 6.91 | 9.68 |
| 60 | 2.08 | 4.10 | 6.93 | 9.66 |
| 65 | 2.07* | 4.10* | 6.92* | 9.61* |
| 70 | 2.07 | 4.11 | 6.92 | 9.57 |
| 75 | 2.04* | 4.13* | 6.92* | 9.54* |
| 80 | 2.02 | 4.15 | 6.93 | 9.52 |
| 85 | 2.03* | 4.17* | 6.95* | 9.47* |
| 90 | 2.04 | 4.20 | 6.97 | 9.43 |
| 95 | 2.05* | 4.22* | 6.99* | 9.38* |

* extrapolated

pH

-04- Technical buffers to NIST

| °C | pH | | | | |
|-----------|-------------|--------------|-------------|--------------|--------------|
| 0 | 1.67 | 4.00 | 7.115 | 10.32 | 13.42 |
| 5 | 1.67 | 4.00 | 7.085 | 10.25 | 13.21 |
| 10 | 1.67 | 4.00 | 7.06 | 10.18 | 13.01 |
| 15 | 1.67 | 4.00 | 7.04 | 10.12 | 12.80 |
| 20 | 1.675 | 4.00 | 7.015 | 10.06 | 12.64 |
| 25 | 1.68 | 4.005 | 7.00 | 10.01 | 12.46 |
| 30 | 1.68 | 4.015 | 6.985 | 9.97 | 12.30 |
| 35 | 1.69 | 4.025 | 6.98 | 9.93 | 12.13 |
| 40 | 1.69 | 4.03 | 6.975 | 9.89 | 11.99 |
| 45 | 1.70 | 4.045 | 6.975 | 9.86 | 11.84 |
| 50 | 1.705 | 4.06 | 6.97 | 9.83 | 11.71 |
| 55 | 1.715 | 4.075 | 6.97 | 9.83* | 11.57 |
| 60 | 1.72 | 4.085 | 6.97 | 9.83* | 11.45 |
| 65 | 1.73 | 4.10 | 6.98 | 9.83* | 11.45* |
| 70 | 1.74 | 4.13 | 6.99 | 9.83* | 11.45* |
| 75 | 1.75 | 4.14 | 7.01 | 9.83* | 11.45* |
| 80 | 1.765 | 4.16 | 7.03 | 9.83* | 11.45* |
| 85 | 1.78 | 4.18 | 7.05 | 9.83* | 11.45* |
| 90 | 1.79 | 4.21 | 7.08 | 9.83* | 11.45* |
| 95 | 1.805 | 4.23 | 7.11 | 9.83* | 11.45* |

* Values complemented

-05- NIST standard buffers
NIST Standard (DIN 19266 : 2015-05)

| °C | pH | | | | |
|-----------|--------------|--------------|--------------|--------------|---------------|
| 0 | 1.666 | 4.000 | 6.984 | 9.464 | |
| 5 | 1.668 | 3.998 | 6.951 | 9.395 | 13.207 |
| 10 | 1.670 | 3.997 | 6.923 | 9.332 | 13.003 |
| 15 | 1.672 | 3.998 | 6.900 | 9.276 | 12.810 |
| 20 | 1.675 | 4.000 | 6.881 | 9.225 | 12.627 |
| 25 | 1.679 | 4.005 | 6.865 | 9.180 | 12.454 |
| 30 | 1.683 | 4.011 | 6.853 | 9.139 | 12.289 |
| 35 | 1.688 | 4.018 | 6.844 | 9.102 | 12.133 |
| 37 | | 4.022 | 6.841 | 9.088 | |
| 38 | 1.691 | | | | 12.043 |
| 40 | 1.694 | 4.027 | 6.838 | 9.068 | 11.984 |
| 45 | | | | | 11.841 |
| 50 | 1.707 | 4.050 | 6.833 | 9.011 | 11.705 |
| 55 | 1.715 | 4.075 | 6.834 | 8.985 | 11.574 |
| 60 | 1.723 | 4.091 | 6.836 | 8.962 | 11.449 |
| 70 | 1.743 | 4.126 | 6.845 | 8.921 | |
| 80 | 1.766 | 4.164 | 6.859 | 8.885 | |
| 90 | 1.792 | 4.205 | 6.877 | 8.850 | |
| 95 | 1.806 | 4.227 | 6.886 | 8.833 | |

Note:

The actual pH values of the individual batches of the reference materials are documented in a certificate of an accredited laboratory. This certificate is supplied with the respective buffers. Only these pH(S) values shall be used as standard values for the secondary reference buffer materials. Correspondingly, this standard does not include a table with standard pH values for practical use. The table above only provides examples of pH(PS) values for orientation.

pH

-06- HACH buffers
Nominal values: 4.01 7.00 10.01 ($\pm 0,02$ at 25 °C)

| °C | pH | | |
|----|-------|-------|-------|
| 0 | 4.00 | 7.118 | 10.30 |
| 5 | 4.00 | 7.087 | 10.23 |
| 10 | 4.00 | 7.059 | 10.17 |
| 15 | 4.00 | 7.036 | 10.11 |
| 20 | 4.00 | 7.016 | 10.05 |
| 25 | 4.01 | 7.000 | 10.01 |
| 30 | 4.01 | 6.987 | 9.96 |
| 35 | 4.02 | 6.977 | 9.92 |
| 40 | 4.03 | 6.970 | 9.88 |
| 45 | 4.05 | 6.965 | 9.85 |
| 50 | 4.06 | 6.964 | 9.82 |
| 55 | 4.07 | 6.965 | 9.79 |
| 60 | 4.09 | 6.968 | 9.76 |
| 65 | 4.10* | 6.98* | 9.71* |
| 70 | 4.12* | 7.00* | 9.66* |
| 75 | 4.14* | 7.02* | 9.63* |
| 80 | 4.16* | 7.04* | 9.59* |
| 85 | 4.18* | 7.06* | 9.56* |
| 90 | 4.21* | 7.09* | 9.52* |
| 95 | 4.24* | 7.12* | 9.48* |

* Values complemented

-07- WTW techn. buffers

| °C | pH | | | |
|-----------|-------------|-------------|-------------|--------------|
| 0 | 2.03 | 4.01 | 7.12 | 10.65 |
| 5 | 2.02 | 4.01 | 7.09 | 10.52 |
| 10 | 2.01 | 4.00 | 7.06 | 10.39 |
| 15 | 2.00 | 4.00 | 7.04 | 10.26 |
| 20 | 2.00 | 4.00 | 7.02 | 10.13 |
| 25 | 2.00 | 4.01 | 7.00 | 10.00 |
| 30 | 1.99 | 4.01 | 6.99 | 9.87 |
| 35 | 1.99 | 4.02 | 6.98 | 9.74 |
| 40 | 1.98 | 4.03 | 6.97 | 9.61 |
| 45 | 1.98 | 4.04 | 6.97 | 9.48 |
| 50 | 1.98 | 4.06 | 6.97 | 9.35 |
| 55 | 1.98 | 4.08 | 6.98 | |
| 60 | 1.98 | 4.10 | 6.98 | |
| 65 | 1.99 | 4.13 | 6.99 | |
| 70 | 2.00 | 4.16 | 7.00 | |
| 75 | 2.00 | 4.19 | 7.02 | |
| 80 | 2.00 | 4.22 | 7.04 | |
| 85 | 2.00 | 4.26 | 7.06 | |
| 90 | 2.00 | 4.30 | 7.09 | |
| 95 | 2.00 | 4.35 | 7.12 | |

pH

-08- Hamilton Duracal buffers

| °C | pH | | | | |
|-----------|-------------|-------------|-------------|--------------|--------------|
| 0 | 1.99 | 4.01 | 7.12 | 10.23 | 12.58 |
| 5 | 1.99 | 4.01 | 7.09 | 10.19 | 12.46 |
| 10 | 2.00 | 4.00 | 7.06 | 10.15 | 12.34 |
| 15 | 2.00 | 4.00 | 7.04 | 10.11 | 12.23 |
| 20 | 2.00 | 4.00 | 7.02 | 10.06 | 12.11 |
| 25 | 2.00 | 4.01 | 7.00 | 10.01 | 12.00 |
| 30 | 1.99 | 4.01 | 6.99 | 9.97 | 11.90 |
| 35 | 1.98 | 4.02 | 6.98 | 9.92 | 11.80 |
| 40 | 1.98 | 4.03 | 6.97 | 9.86 | 11.70 |
| 45 | 1.97 | 4.04 | 6.97 | 9.83 | 11.60 |
| 50 | 1.97 | 4.05 | 6.97 | 9.79 | 11.51 |
| 55 | 1.98 | 4.06 | 6.98 | 9.75 | 11.42 |
| 60 | 1.98 | 4.08 | 6.98 | 9.72 | 11.33 |
| 65 | 1.98 | 4.10* | 6.99* | 9.69* | 11.24 |
| 70 | 1.99 | 4.12* | 7.00* | 9.66* | 11.15 |
| 75 | 1.99 | 4.14* | 7.02* | 9.63* | 11.06 |
| 80 | 2.00 | 4.16* | 7.04* | 9.59* | 10.98 |
| 85 | 2.00 | 4.18* | 7.06* | 9.56* | 10.90 |
| 90 | 2.00 | 4.21* | 7.09* | 9.52* | 10.82 |
| 95 | 2.00 | 4.24* | 7.12* | 9.48* | 10.74 |

* Values complemented

-09- Reagecon buffers

| °C | pH | | | | |
|-------------|-------------|-------------|-------------|-------------|--------------|
| 0°C | *2.01 | *4.01 | *7.07 | *9.18 | *12.54 |
| 5°C | *2.01 | *4.01 | *7.07 | *9.18 | *12.54 |
| 10°C | 2.01 | 4.00 | 7.07 | 9.18 | 12.54 |
| 15°C | 2.01 | 4.00 | 7.04 | 9.12 | 12.36 |
| 20°C | 2.01 | 4.00 | 7.02 | 9.06 | 12.17 |
| 25°C | 2.00 | 4.00 | 7.00 | 9.00 | 12.00 |
| 30°C | 1.99 | 4.01 | 6.99 | 8.95 | 11.81 |
| 35°C | 2.00 | 4.02 | 6.98 | 8.90 | 11.63 |
| 40°C | 2.01 | 4.03 | 6.97 | 8.86 | 11.47 |
| 45°C | 2.01 | 4.04 | 6.97 | 8.83 | 11.39 |
| 50°C | 2.00 | 4.05 | 6.96 | 8.79 | 11.30 |
| 55°C | 2.00 | 4.07 | 6.96 | 8.77 | 11.13 |
| 60°C | 2.00 | 4.08 | 6.96 | 8.74 | 10.95 |
| 65°C | *2.00 | *4.10 | *6.99 | *8.70 | *10.95 |
| 70°C | *2.00 | *4.12 | *7.00 | *8.67 | *10.95 |
| 75°C | *2.00 | *4.14 | *7.02 | *8.64 | *10.95 |
| 80°C | *2.00 | *4.16 | *7.04 | *8.62 | *10.95 |
| 85°C | *2.00 | *4.18 | *7.06 | *8.60 | *10.95 |
| 90°C | *2.00 | *4.21 | *7.09 | *8.58 | *10.95 |
| 95°C | *2.00 | *4.24 | *7.12 | *8.56 | *10.95 |

* Values complemented

pH

-10- DIN 19267 buffers

| °C | pH | | | | |
|-----------|-------------|-------------|-------------|-------------|--------------|
| 0 | 1,08 | 4,67 | 6,89 | 9,48 | 13,95* |
| 5 | 1,08 | 4,67 | 6,87 | 9,43 | 13,63* |
| 10 | 1,09 | 4,66 | 6,84 | 9,37 | 13,37 |
| 15 | 1,09 | 4,66 | 6,82 | 9,32 | 13,16 |
| 20 | 1,09 | 4,65 | 6,80 | 9,27 | 12,96 |
| 25 | 1,09 | 4,65 | 6,79 | 9,23 | 12,75 |
| 30 | 1,10 | 4,65 | 6,78 | 9,18 | 12,61 |
| 35 | 1,10 | 4,65 | 6,77 | 9,13 | 12,45 |
| 40 | 1,10 | 4,66 | 6,76 | 9,09 | 12,29 |
| 45 | 1,10 | 4,67 | 6,76 | 9,04 | 12,09 |
| 50 | 1,11 | 4,68 | 6,76 | 9,00 | 11,89 |
| 55 | 1,11 | 4,69 | 6,76 | 8,96 | 11,79 |
| 60 | 1,11 | 4,70 | 6,76 | 8,92 | 11,69 |
| 65 | 1,11 | 4,71 | 6,76 | 8,90 | 11,56 |
| 70 | 1,11 | 4,72 | 6,76 | 8,88 | 11,43 |
| 75 | 1,11 | 4,73 | 6,77 | 8,86 | 11,31 |
| 80 | 1,12 | 4,75 | 6,78 | 8,85 | 11,19 |
| 85 | 1,12 | 4,77 | 6,79 | 8,83 | 11,09 |
| 90 | 1,13 | 4,79 | 6,80 | 8,82 | 10,99 |
| 95 | 1,13* | 4,82* | 6,81* | 8,81* | 10,89* |

* Values extrapolated

You can specify a buffer set with 2 buffer solutions in the temperature range of 0 ... 95 °C, step width: 5 °C.

To do so, select buffer set -U1- in the configuration menu.

As delivered, the Ingold technical buffer solutions pH 4.01 / 7.00 are stored as buffer set and can be edited.



Conditions for the specifiable buffer set:

- All values must lie in the range pH 0 ... 14.
- Maximum difference between two adjacent pH values (5 °C step width) of the same buffer solution: pH 0.25
- The values of buffer solution 1 must be lower than those of buffer solution 2:
The difference between values for identical temperatures must be greater than 2 pH units.

Faulty entries are indicated in measuring mode by the "FAIL BUFFERSET -U1-" message.

The 25 °C value is always used for buffer display during calibration.

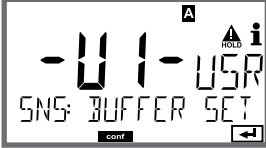
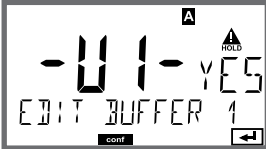
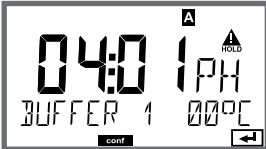
pH

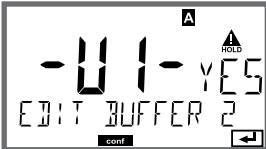
| Step | Action/Display | Remark |
|--|--|--|
| Select buffer set -U1- (CONFIG / SNS menu) |  | |
| Select buffer solution 1 for editing. |  <p data-bbox="384 651 650 715">Select "YES" using up/down arrow.</p> | You are prompted for confirmation to prevent accidental changes of the settings. |
| Editing the values Buffer solution 1 |  <p data-bbox="384 895 693 1023">Edit: using arrow keys, press enter to confirm and proceed to next temperature value.</p>  | Enter the values for the first buffer solution in 5 °C steps. The difference to the next value must not exceed 0.25 pH unit. |
| Select buffer solution 2 for editing. |  | The difference between buffer solutions for identical temperatures must be greater than 2 pH units. |

Buffer set U1:

Fill in your configuration data or use the table as original for copy.

| Temperature (°C) | Buffer 1 | Buffer 2 |
|------------------|----------|----------|
| 5 | | |
| 10 | | |
| 15 | | |
| 20 | | |
| 25 | | |
| 30 | | |
| 35 | | |
| 40 | | |
| 45 | | |
| 50 | | |
| 55 | | |
| 60 | | |
| 65 | | |
| 70 | | |
| 75 | | |
| 80 | | |
| 85 | | |
| 90 | | |
| 95 | | |

A

- Accessories 158
- ACT (adaptive cal timer, ISM sensors), pH 64
- Activate Sensocheck 99
- Adaptive cal timer (pH) 64
- Adaptive maintenance timer (pH) 66
- Adaptive maintenance timer, resetting 146
- Alarm, contact characteristics 99
- Alarm, CONTROL input 100
- Alarm, delay 98
- Alarm, description 48
- Alarm, flow monitoring 100
- Alarm, Sensocheck 99
- Ambulance TAN if passcode is lost 148
- Application example 13
- Assembly 14
- Assigning measured values, current start/end 87
- Asymmetry potential to sensor zero point 131
- Audit Trail, viewing entries 143
- Autoclaving counter, configuration 70
- Autoclaving counter, incrementing 146
- Automatic calibration, pH 126

B

- Backlighting 42
- Buffer tables 165
- Buttons and functions 41

C

- Cable type Memosens 36
- Calibration 122
- Calibration data, display 141
- Calibration mode, configuring (pH) 61
- Calibration, ORP 132
- Calibration (pH) 123
- Calibration (pH) by entering data from premeasured sensors 130
- Calibration (pH), zero adjustment 125
- Calibration timer 63
- Calibration with sampling 134
- CAL_ORP 123
- CAL_PH 123

- Capacitive loads, protective wiring of relay contacts 108
- Channel selection and display assignment (MSPH-MSPH) 76
- Ciba (94) buffers, buffer table 167
- CIP (cleaning cycles) 69
- Cleaning contact, configuration 118
- Cleaning cycles, ISM sensor (pH), configuration 68
- Colors in display 42
- Configuration, alarm 98
- Configuration, calibration mode 60
- Configuration, calibration timer 62
- Configuration, CIP/SIP settings 68
- Configuration, controller 114
- Configuration, current output 86
- Configuration, limit function 102
- Configuration (multi-channel), overview 80
- Configuration (pH) 58
- Configuration (pH), overview 55
- Configuration, pulse frequency controller (PFC) 115
- Configuration, pulse length controller (PLC) 115
- Configuration, relay contacts 102
- Configuration, Sensocheck 98
- Configuration, TAG/GROUP 120
- Configuration, time and date 120
- Configuration, time averaging filter 88
- Configuration, WASH contact 118
- Connecting a Memosens sensor, menu 53
- Connecting a pH sensor (examples) 26
- Connecting cable, Memosens 36
- Connection length for sensors, maximum (MSPH-MSPH) 76
- Contact, alarm, configuring 99
- Control Drawings 8
- CONTROL input, flow measurement 96
- CONTROL input, parameter set selection 94
- Control inputs 11
- Controller characteristic 111
- Controller equations 112
- Controller output/setpoint, display 139
- Converting slope to mV 131
- Current output, configuration 86
- Current start/end, assigning measured values 87

D

- Data input (pH calibration) 130
- Data logger, description 10
- Data logger, viewing entries 143
- Date and time, usage 121
- Date, display 136
- Date, setting 120
- Device self-test 142
- Device start blocked 149
- Device type, display 144
- Device type MSPH-MSOXY 79
- Device type MSPH-MSPH 76
- Device type pH, configuration 58
- Device type, selecting the measuring function 148
- Diagnostics, calibration data 141
- Diagnostics, device self-test 142
- Diagnostics, hardware and software version 144
- Diagnostics, logbook 143
- Diagnostics mode 140
- Diagnostics, sensor data 141
- Diagnostics, sensor monitor 144
- Digital sensors (pH), select sensor type 59
- Dimensions 15
- DIN 19267 buffers, buffer table 174
- Display 42
- Display backlighting 44
- Displaying the time/date 136
- Display in measuring mode 43
- Display output current 136
- Display, selecting the main display 43
- Display test 142
- Display test 142
- Disposal 7
- Documentation 8
- Dual devices 75

E

EEPROM test, device self-test 142
Enclosure components 14
ERR 151
Error and HOLD, output current 90
Error messages 151
Error messages, configure output current 91
EU Declarations of Conformity 8
Extended logbook (via TAN) 143

F

Factory setting, reset 148
FIRMW UPDATE 149
FLASH test 142
FLOW 97
Flow measurement 96
Flow measurement, alarm 100
Flow measurement, generate message 48

G

GROUP of measuring points 121
GROUP, sensor verification 73

H

HACH buffers, buffer table 170
Hamilton Duracal buffers, buffer table 172
HOLD, behavior of PID controller 113
HOLD, configure output current 90
HOLD, exit 47
HOLD, external activation 47
HOLD mode 47
HOLD, output signal during HOLD 47
HOLD, output signal response 47
Hose clamps 16
Hysteresis, application 105

I

Icons 42
Inductive loads, protective wiring of relay contacts 108
Info text 151
Inserting a module 24
Installation, terminal assignments 21
Interchangeable modules, product range 157

ISFET-ZERO, zero adjustment (ISFET sensors) 123
ISM sensors (pH), configure adaptive cal timer 64
ISM sensors (pH), configure adaptive maintenance timer 66
ISM sensors (pH), configure autoclaving counter 70

K

Keypad 41
Knick CaliMat, buffer table 166

L

Limit value 1, relay 102
Limit value 2, relay 106
Linear temperature compensation (pH) 93
Logbook 143

M

MAIN DISPLAY 43
Manual calibration with buffer entry 128
Measured values, viewing (sensor monitor) 144
Measuring function (device type) 148
Measuring mode 136
Measuring mode for temperature detection 59
Measuring mode, general 40
Measuring modules, product range 157
Measuring pH, wiring examples 26
Measuring point, arrangement (MSPH-MSPH) 76
Measuring point, TAG/GROUP 120
Memosens cable, connection 35
Memosens cable (specifications, order code) 36
Memosens, dual devices 75
Memosens sensor (connection, menu) 53
Memosens sensor, replacement 54
Memosens sensor, start-up 34
MemoSuite software for calibrating Memosens sensors 34
Menu groups (configuration) 50
Menus, overview 49
Messages, alarm and HOLD 48
Message via CONTROL input 48
Mettler-Toledo buffers, buffer table 165
Module for 2nd Memosens channel 37
Module, inserting 24
Module test 142

Mounting accessories 15
Mounting accessories, product range 158
Mounting plan 15

N

Neutral zone, controller 111
NIST standard buffers, buffer table 169
NIST technical buffers, buffer table 168

O

Operating error FIRMW UPDATE 149
Operating mode, selection 45
Operating modes, overview 49
Operating modes, short description 46
Operating states 156
Operation, general 40
Options, enabling 148
Order codes 157
ORP calibration 132
Output current during Error and HOLD 90
Output current, range 87
Output currents, display 136
Output current, time averaging filter 88
Output current value, Service mode 147
Output filter, time interval 88
Output signal, controller behavior 116
Output signal during HOLD 91
Output voltage, adjusting (POWER OUT) 146
Overview of parameter sets 51

P

Package contents, complete 14
Package contents, documentation 8
Panel mounting 17
Parameter set A/B, display 136
Parameter set A/B, introduction 10
Parameter set A/B, overview of menu groups 51
Parameter set A/B, signaling via WASH contact 52
Parameter set A/B, switchover 51
Parameter set selection, configuration 94
Passcode lost 148
Passcodes, assigning and editing 148

- P_CAL, product calibration (calibration with sampling) 123
- Pfaunder sensors, connection 33
- Pfaunder sensors, description and specifications 57
- PFC, pulse frequency controller 113
- pH, automatic calibration 126
- pH calibration, presetting 123
- pH configuration 58
- pH, manual calibration 128
- pH module 25
- pH/ORP measurement (wiring examples) 26
- pH, premeasured sensors 130
- PID controller and behavior during HOLD 113
- PID controller, configuration 114
- PID controller, description 111
- Pipe mounting 16
- PLC, pulse length controller 113
- POWER OUT, adjusting the output voltage 146
- Power supply, connection 20
- Power supply ratings 20
- Process variable not loaded 149
- Process variable selection 87
- Product calibration 134
- Product range 157
- Protective hood 16
- Protective wiring of relay contacts 108
- Pulse frequency controller (PFC) 113
- Pulse frequency controller (PFC), configuration 115
- Pulse length controller (PLC) 113
- Pulse length controller (PLC), configuration 115

Q

- Quickstart guides 8

R

- RAM test 142
- Rating plates 19
- Reagecon buffers, buffer table 173
- Redox calibration (ORP) 132
- Relay 1 102
- Relay 2 106

Relay contacts, configuration 102
Relay contacts, protective wiring 108
Relay contacts (schematic) 12
Relay test 147
Release of options 148
Reset to factory settings 148
Return of products under warranty 7
rH calculation 132

S

Safety instructions 8
Sensocheck, configuration 98
Sensocheck, description 155
Sensoface, configure output current 91
Sensoface, description 155
Sensoface messages, overview 154
Sensor connection, analog sensors 24
Sensor connection, Memosens 20
Sensor data, display 141
Sensor monitor, displaying the currently measured values 144
Sensor monitor, Service mode 146
Sensor replacement 54
Sensor verification (TAG, GROUP) 72
Serial number, display 144
Series resistors 108
Service, activating an option 148
Service, factory settings 148
Service, incrementing the autoclaving counter 146
Service life of contacts 108
Service mode 145
Service passcode lost 148
Service, passcodes 148
Service, relay test 147
Service, resetting the TTM interval 146
Service, sensor monitor 146
Service, specifying the current outputs 147
Settings of U1 buffer set 177
Setting the passcodes 148
Signal colors 44

SIP (sterilization cycles) 69
Software version, display 144
Specifiable buffer set, -U1- 175
Specifications 159
Specifications, Memosens cable 36
Specific test report 8
Start-up, measuring function 23
Sterilization cycles, configuration 68

T
Tag number, display 136
TAG of measuring point 121
TAG, sensor verification 73
TAN options, activation 148
TAN options, overview 157
Technical buffers to NIST, buffer table 168
Technical data 159
Temp detection during calibration 60
Temperature compensation (pH) 92
Temperature dependence of commonly used reference systems 132
Temperature probe selection 59
Terminal assignments 20
Terminal plate of device 19
Time and date, usage 121
Time averaging filter 89
Time, display 136
Time format, setting 120
Time, setting 120
TTM, configure adaptive maintenance timer (pH) 66

U
U1, specifiable buffer set 175

W
WASH contact, configuration 118
WASH contact (signaling parameter set) 52
Wiring 20
Wiring examples, Memosens pH 38
Wiring examples, pH 26
Wiring of pH sensors (examples) 26
WTW technical buffers, buffer table 171

Z

Zero adjustment for ISFET sensors 124

ZU 0274, pipe-mount kit 16

ZU 0737, protective hood 16

ZU 0738, panel-mount kit 17

Knick
Elektronische Messgeräte GmbH & Co. KG

Beuckestraße 22
14163 Berlin
Germany

Phone: +49 30 80191-0
Fax: +49 30 80191-200
Web: www.knick.de
Email: info@knick.de

Stratos Evo A402: pH Measurement

TA-212.101-pH-KNE01 20170831



Software version: 1.x