

# Protos II 4400(X) / Protos 3400(X) Process Analysis System

User Manual

**Protos PH 3400(X)-033 Measuring Module**  
For Simultaneous Measurement of pH Value and  
Temperature with Pfauder Differential Probes

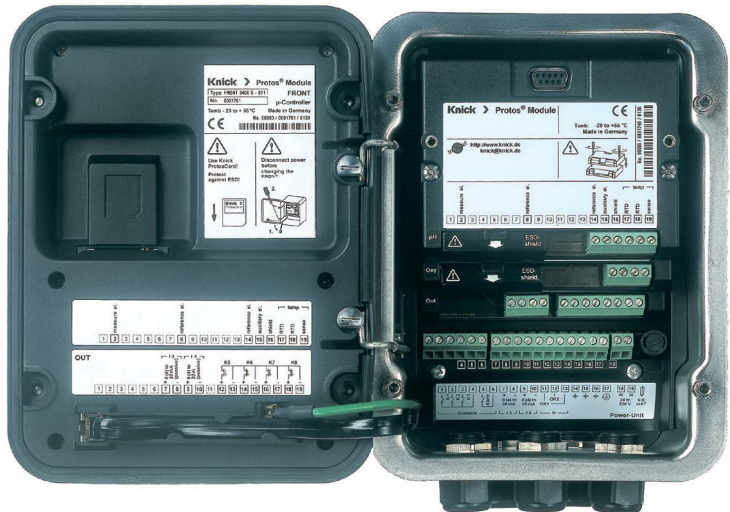

## Returns

Please contact our Service Team before returning a defective device. Ship the cleaned device to the address you have been given.

If the device has been in contact with process medium, it must be decontaminated/disinfected before shipment. In this case, place a Declaration of Contamination in the consignment to prevent any risk to the health and safety of our service personnel. The declaration is available at:



<https://www.knick-international.com/en/service/repairs/>

## Disposal

Please observe the applicable local or national regulations concerning the disposal of "waste electrical and electronic equipment".

## Trademarks

The following trademarks are used in this document without further marking:

Calimatic®, Protos®, Sensocheck®, Sensoface®, Unical®, VariPower®, Ceramat®, SensoGate® are registered trademarks of Knick Elektronische Messgeräte GmbH & Co. KG, Germany

Memosens®

is a registered trademark of

Endress+Hauser Conducta GmbH & Co. KG, Germany

Knick Elektronische Messgeräte GmbH & Co. KG, Germany

# Table of Contents

---

Protos PH 3400(X)-033 Module

Returns .....	2
Disposal .....	2
Trademarks .....	2
<b>Intended Use .....</b>	<b>6</b>
<b>Safety Instructions .....</b>	<b>7</b>
Operation in Explosive Atmospheres: PH 3400X-033 Module .....	7
<b>Firmware Version .....</b>	<b>8</b>
<b>Terminal Plate PH 3400-033 Module .....</b>	<b>9</b>
<b>Installing the Module .....</b>	<b>11</b>
<b>Wiring Examples .....</b>	<b>12</b>
<b>Calibration / Adjustment .....</b>	<b>14</b>
Calibration methods .....	16
Temperature compensation.....	17
HOLD Function During Calibration .....	18
Automatic Buffer Recognition (Calimatic) .....	20
Calibration with Manual Entry of Buffer Values .....	22
Product Calibration (Calibration with Sampling) .....	24
Data Entry of Premeasured Electrodes .....	26
Determination of Nominal Zero .....	28
Temp Probe Adjustment.....	30
<b>Parameter Setting .....</b>	<b>31</b>
Parameter Setting: Operating Levels .....	32
Parameter Setting: Locking a Function .....	33
Activating Parameter Setting .....	34
Settings of Sensor Data.....	35
Sensoface .....	37
Sensocheck.....	37
Sensoface criteria .....	38
Cal preset values.....	39
Tolerance adjustment.....	39
Calimatic buffer.....	42
Calibration timer.....	42

# Table of Contents

---

Protos PH 3400(X)-033 Module

Cal tolerance band.....	42
TC process medium.....	44
Temperature Compensation of Process Medium.....	45
ORP/rH value.....	46
Delta function.....	46
Calculation Blocks.....	47
Logbook.....	50
Restore Factory Settings.....	50
Messages: Default settings and selection range.....	51
Configuring a Current Output.....	53
Current Outputs: Characteristics.....	54
Current Outputs: Output Filter.....	56
<b>Maintenance.....</b>	<b>57</b>
Sensor monitor.....	57
Temp probe adjustment.....	57
<b>Diagnostic Functions.....</b>	<b>58</b>
Message list.....	58
Logbook.....	58
Device description.....	59
FRONT module.....	59
BASE module.....	59
Module diagnostics.....	60
Sensor monitor.....	60
Calibration timer.....	61
Adaptive calibration timer.....	61
Tolerance adjustment.....	61
Cal record.....	62
Sensor diagram.....	62
Statistics.....	62
Messages.....	67

# Table of Contents

---

Protos PH 3400(X)-033 Module

<b>Specifications</b> .....	<b>73</b>
<b>Appendix:</b> .....	<b>77</b>
Minimum spans for current outputs.....	77
Buffer table "Mettler-Toledo" .....	78
Buffer table "Knick CaliMat" .....	79
Buffer table "DIN 19267" .....	80
Buffer table "NIST standard" (DIN 19266: 2000-01) .....	81
Buffer table "Techn. buffers to NIST" .....	82
Buffer table "Hamilton" .....	83
Buffer table "Kraft" .....	84
Buffer table "Hamilton A" .....	85
Buffer table "Hamilton B" .....	86
Buffer table "HACH" .....	87
Buffer table "Ciba" .....	88
Buffer table "Reagecon" .....	89
Specifiable Buffer Sets .....	91
<b>Overview</b> .....	<b>92</b>
Overview of Parameter Setting.....	92
<b>Index</b> .....	<b>96</b>

# Intended Use

---

The module is used for simultaneous pH and temperature measurement with Pfaudler differential probes.

The PH 3400X-033 module is intended for operation in locations subject to explosion hazards which require equipment of Group II, device category 2(1), gas/dust.

# Safety Instructions

---

## Operation in Explosive Atmospheres: PH 3400X-033 Module

The module is approved for operation in explosive atmospheres.

When installing the product in a hazardous location, observe the information in the supplements to the certificates and, if applicable, the relevant control drawings.

Observe all applicable local and national codes and standards for the installation of electrical equipment in explosive atmospheres. For orientation, please refer to IEC 60079-14, EU directives 2014/34/EU and 1999/92/EC (ATEX), NFPA 70 (NEC), ANSI/ISA-RP12.06.01.

**⚠ WARNING!** Possible impairment of explosion protection.

- Modules which have already been used shall be subjected to a professional routine test before they may be operated in another type of protection.
- Prior to commissioning, the operating company must verify the intrinsic safety in accordance with the installation regulations of IEC 60079-14 for the complete interconnection of all equipment involved, including the connecting cables.
- The interconnection of Ex and non-Ex modules (mixed assembly) is not permitted.
- In hazardous locations the device shall only be cleaned with a damp cloth to prevent electrostatic charging.

## Maintenance

The Protos modules cannot be repaired by the user. For inquiries regarding module repair, please contact Knick Elektronische Messgeräte GmbH & Co. KG at [www.knick.de](http://www.knick.de).

# Firmware Version

## PH 3400(X)-033 module firmware: Firmware version 2.x

Module compatibility	PH 3400-033	PH 3400X-033
Protos 3400 from FRONT firmware version 4.0	x	
Protos 3400X from FRONT firmware version 4.0		x
Protos II 4400 from FRONT firmware version 1.0.0	x	
Protos II 4400X from FRONT firmware version 1.0.0		x

## Query Current Device Firmware/Module Firmware

When the device is in measuring mode:

Press **menu** key, open Diagnostics menu: Device Description

Note: The display may vary depending on the device version.

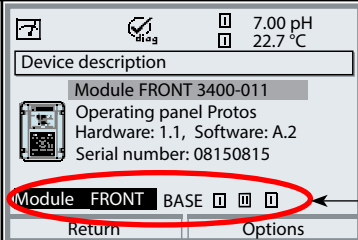
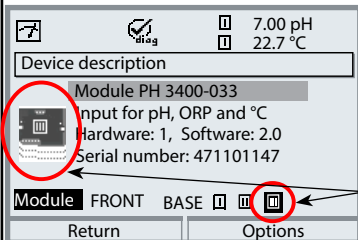
Menu	Display	Device description
 <b>diag</b>	 <p>7.00 pH 22.7 °C</p> <p>Device description</p> <p>Module FRONT 3400-011 Operating panel Protos Hardware: 1.1, Software: A.2 Serial number: 08150815</p> <p>Module FRONT BASE [ ] [ ] [ ]</p> <p>Return Options</p>	<h3>Device hardware and firmware version</h3> <p>Provides information on all modules installed: Module type and function, serial number, hardware and firmware version, and device options. Select the different modules (FRONT, BASE, slots 1 - 3) using the arrow keys.</p>
	 <p>7.00 pH 22.7 °C</p> <p>Device description</p> <p>Module PH 3400-033 Input for pH, ORP and °C Hardware: 1, Software: 2.0 Serial number: 471101147</p> <p>Module FRONT BASE [ ] [ ] [ ]</p> <p>Return Options</p>	<h3>Query module software</h3> <p>Module PH 3400-033, hardware and firmware version, serial number – here installed in slot 3.</p>







# Installing the Module

---

## ⚠ CAUTION! Electrostatic discharge (ESD).

The modules' signal inputs are sensitive to electrostatic discharge.

Take measures to protect against ESD before inserting the module and wiring the inputs.

**Note:** Strip the insulation from the wires using a suitable tool to prevent damage.



- 1) Switch off the power supply to the device.
- 2) Open the device (loosen the 4 screws on the front).
- 3) Plug the module into the slot (D-SUB connector), see figure.
- 4) Tighten the module's fastening screws.
- 5) Open the ESD shield (covering terminals 2 and 8).
- 6) Connect the sensor and separate temperature probe if necessary, see "Wiring Examples".

**Note:** To avoid interferences, the cable shielding must be completely covered by the ESD shield.

- 7) Fit the ESD shield back into place (covering terminals 2 and 8).
- 8) Check whether all connections are correctly wired.
- 9) Close the device by tightening the screws on the front.
- 10) Switch on the power supply.

## ⚠ CAUTION! Incorrect measurement results.

Incorrect parameter setting, calibration or adjustment may result in incorrect measurements being recorded. Protos must therefore be commissioned by a system specialist, all its parameters must be set, and it must be fully adjusted.

# Wiring Examples

pH measurement with Pfaudler differential probe  
Impedance monitoring of measuring and reference electrode

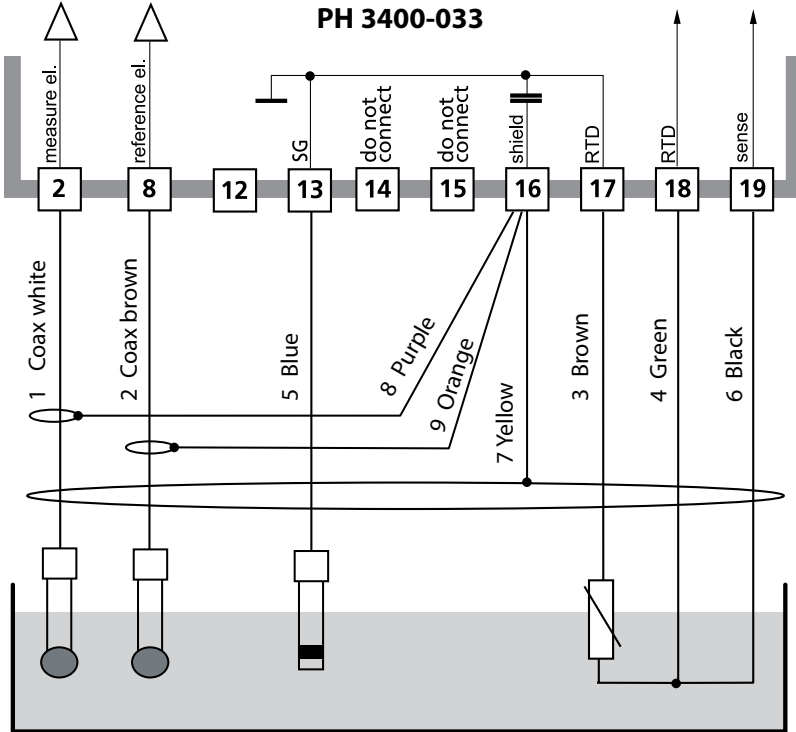

# Wiring Examples

Connection of sensors with VP cap  
e.g. Deltatrode (Hamilton),  
VP cable: VP 6-18/05

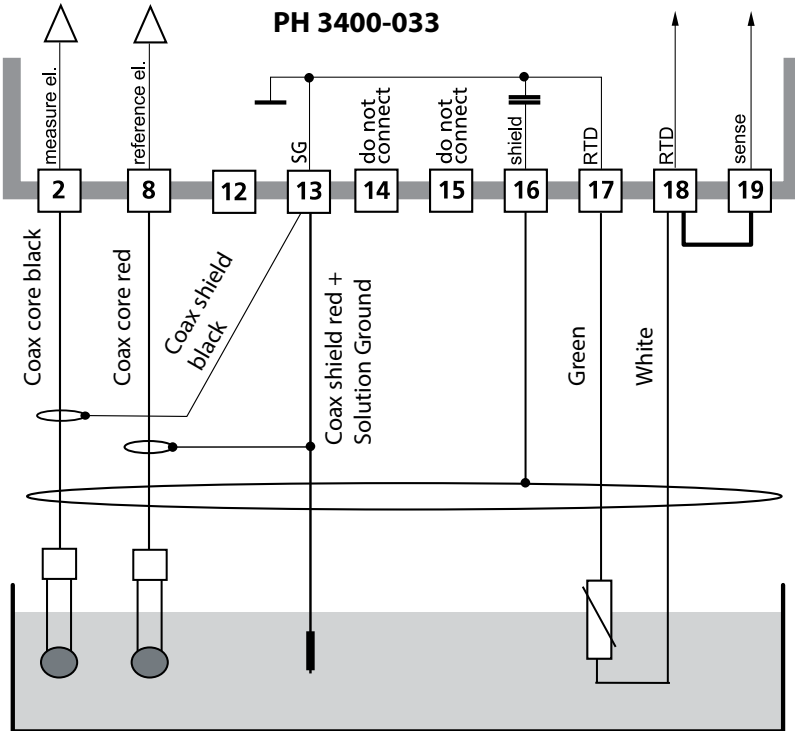

Signal ground  
(Solution Ground)

# Calibration / Adjustment

---

**Note:** Function check (HOLD) active for the currently calibrated module  
Current outputs and relay contacts behave as configured

- **Calibration:** Detecting deviations without readjustment
- **Adjustment:** Detecting deviations with readjustment

## **NOTICE!**

Without adjustment every pH meter delivers an imprecise or wrong output value! Every pH electrode has its individual zero point and its individual slope. Both values are altered by aging and wear.

To determine the correct pH value, the pH meter must be adjusted to the electrode. The analyzer corrects the voltage delivered by the electrode with regard to electrode zero and slope and displays it as the pH value.

Be sure to perform an adjustment after having replaced the electrode!

## **Procedure**

First, a calibration is performed to detect the deviations of the electrode (zero, slope). To do so, the electrode is immersed in buffer solutions whose pH value is exactly known. The measuring module measures the electrode voltages and the buffer solution temperature and automatically calculates the electrode zero and slope. These data are stored in a calibration record. By "Adjustment" the determined calibration data can be used for correction (see following page).

## **Parameters Determined by Calibration**

**Zero** is the pH value at which the pH electrode outputs the voltage 0 mV. It is different for each electrode and changes with age and wear.

**Temperature** of the process solution must be detected since pH measurement is temperature-dependent. Many electrodes have an integrated temperature probe.



**Slope** of an electrode is the voltage change per pH unit. For an ideal pH electrode, it lies at -59.2 mV/pH.

# Calibration / Adjustment

## Adjustment

Adjustment means that the values determined by a calibration are taken over. The values determined for zero and slope are entered in the calibration record. (Cal record can be called up in the Diagnostics menu for the PH 3400(X)-033 module). These values are only effective for calculating the measured variables when the calibration has been terminated with an adjustment. A passcode ensures that an adjustment can only be performed by an authorized person (Administrator). The Operator can check the current sensor data by a calibration and inform the Administrator when there are deviations. You can use the add-on function SW3400-107 / FW4400-107<sup>1)</sup> for granting access rights (passcodes) and for AuditTrail (continuous data recording and backup according to FDA 21 CFR Part 11).

Note: The display may vary depending on the device version.

Menu	Display	Adjustment after calibration
	 <p>8.30 pH 25.6°C</p> <p>Calibration data record</p> <p>Calibration 04/30/10 12:34 Cal mode Product calibration Zero +07.00 pH Slope 058.0 mV/pH</p> <p>End Adjust ↩</p>	<p><b>Administrator</b></p> <p>With the corresponding access rights, the device can immediately be adjusted after calibration. The calibration values are taken over for calculating the measured variables.</p>
	 <p>8.30 pH 25.6°C</p> <p>Module PH 3400-033</p> <p>Stored calibration data record Calibration 04/30/10 12:34</p> <p>Start new calibration View/adjust calibration data record</p> <p>Return</p>	<p><b>Operator (without administrator rights)</b></p> <p>After calibration, change to measuring mode. Inform Administrator. When opening the menu (Calibration, respective module), the Administrator sees all data of the last calibration and can take over the values or perform a new calibration.</p>

1) Protos II 4400(X): FW4400-107 only available from FRONT firmware version 02.xx.xx

# Calibration / Adjustment

---

## Calibration methods

### **One-point calibration**

The electrode is calibrated with one buffer solution only.

Here, only the electrode zero point is detected and taken into account by the Protos. One-point calibration is appropriate and permissible whenever the measured values lie near the electrode zero point so that slope changes do not have much of an impact.

### **Two-point calibration**

The electrode is calibrated with two buffer solutions.

In that case, zero point and slope of the electrode can be detected and taken into account by the Protos. Two-point calibration is required if

- the electrode has been replaced
- the measured pH values cover a wide range
- there is great difference between the measured pH value and the electrode zero
- the pH measurement must be very accurate
- the electrode is exposed to extreme wear.

### **Three-point calibration**

The electrode is calibrated with three buffer solutions.

Zero and slope are calculated using a line of best fit according to DIN 19268.

### **Sensor replacement (First Calibration)**

Each time you replace the electrode, you must perform a "First Calibration".

During First Calibration, the electrode data together with the electrode type and serial number are stored as reference values for electrode statistics.

The "Statistics" menu of Diagnostics shows the deviations of zero, slope, glass and reference electrode impedance, and response time of the last three calibrations with respect to the reference values of the First Calibration.

This allows evaluation of the drift behavior and aging of the electrode.



# Calibration / Adjustment

## Temperature compensation

### Temperature compensation during calibration

There are two important reasons for determining the temperature of the buffer solution:

The slope of the pH electrode is temperature-dependent. Therefore the measured voltage must be corrected by the temperature influence.

The pH value of the buffer solution is temperature-dependent. For calibration, the buffer solution temperature must therefore be known in order to choose the actual pH value from the buffer table.

During parameter setting you define whether cal temperature is measured automatically or must be entered manually:

### Automatic temperature compensation

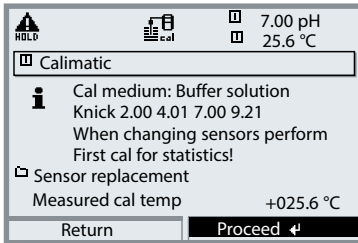

For automatic cal temp detection, the Protos measures the temperature of the buffer solution with a temperature probe (Pt 100/ Pt 1000/ NTC 30 kΩ/NTC 8.55 kΩ). If you work with automatic temperature compensation during calibration, a temperature probe connected to the temperature input of the Protos must be in the buffer solution! Otherwise, you must select manual entry of calibration temperature. When "Cal temp automatic" is set, "Measured cal temp" appears in the menu.

### Manual temperature compensation

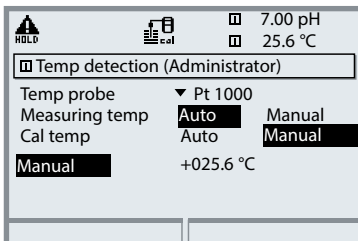

The temperature of the buffer solution must be entered manually in the Parameter setting menu at "Parameter setting / <PH module> / Sensor data / Temp detection / Cal temp --> manual". Temperature measurement is performed using a glass thermometer, for example.

Note: The display may vary depending on the device version.

# HOLD Function During Calibration

Behavior of the signal and relay outputs during calibration

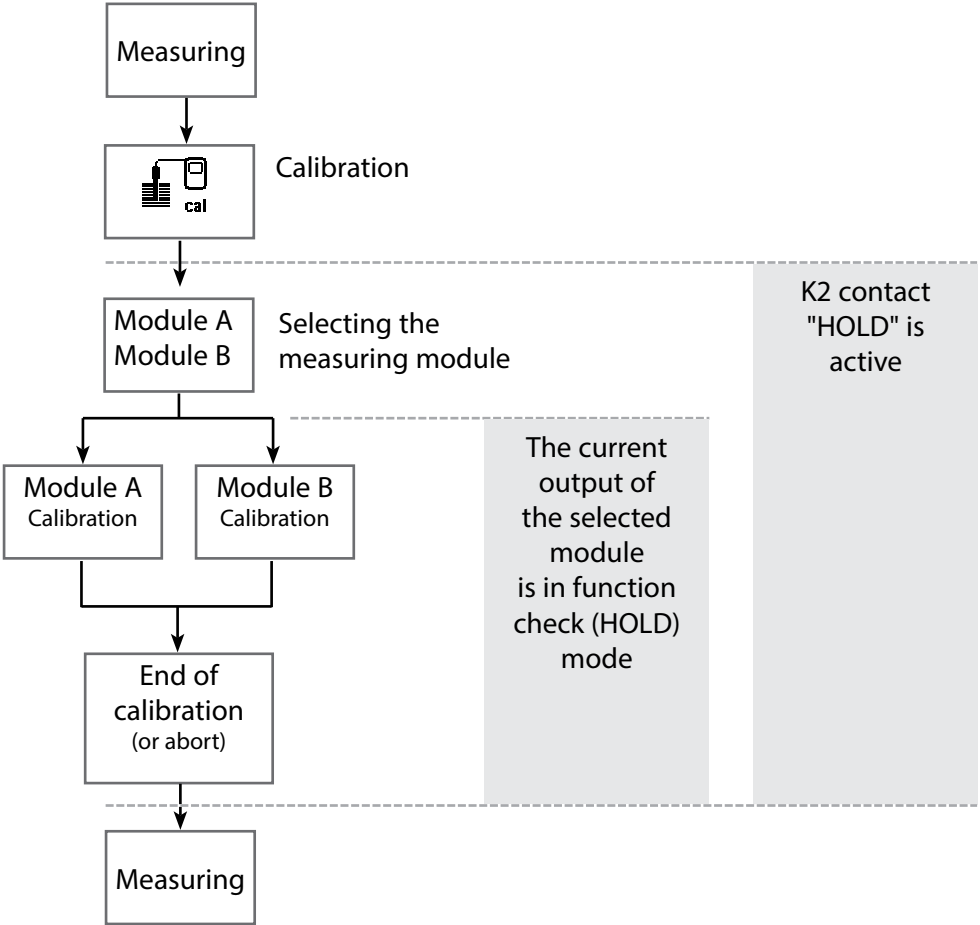

**Note:** The display may vary depending on the device version.

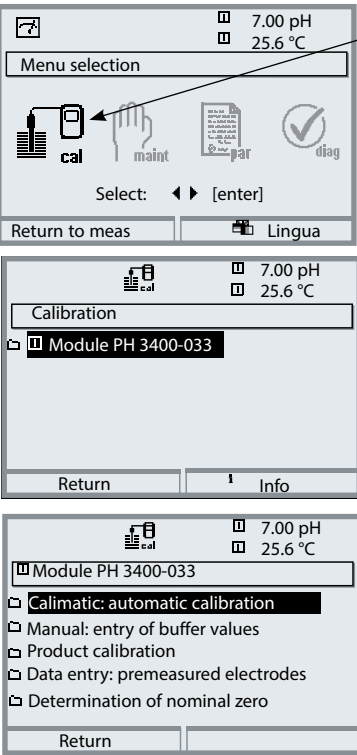
Menu	Display	Select calibration method (pH)
	 <p>The display shows the following sequence of screens:</p> <ul style="list-style-type: none"><li><b>Screen 1:</b> Main menu with '7.00 pH' and '25.6 °C' at the top. A 'Menu selection' bar is present. The 'cal' option is highlighted. Other options include 'maint', 'par', and 'diag'. A 'Select:' prompt with left and right arrow keys and '[enter]' is shown below.</li><li><b>Screen 2:</b> 'Calibration' screen for 'Module PH 3400-033'. It shows '7.00 pH' and '25.6 °C'. Options are 'Return' and 'Info'.</li><li><b>Screen 3:</b> List of calibration methods for 'Module PH 3400-033'. The selected method is 'Calimatic: automatic calibration'. Other options include 'Manual: entry of buffer values', 'Product calibration', 'Data entry: premeasured electrodes', and 'Determination of nominal zero'. 'Return' is at the bottom.</li></ul>	<p><b>Open calibration</b></p> <p>Press <b>menu</b> key to select menu. Select calibration using arrow keys, confirm with <b>enter</b>, passcode 1147 (To change passcode, select: Parameter setting / System control / Passcode entry).</p> <p>Calibration: Select "Module PH"</p> <p>Select calibration method:</p> <ul style="list-style-type: none"><li>• Automatic buffer recognition</li><li>• Manual entry of buffer values</li><li>• Product calibration Calibration with sampling)</li><li>• Data entry of premeasured sensors</li><li>• Determination of nominal zero</li><li>• Temp probe adjustment (with Protos II 4400(X))</li></ul> <p>When you open the Calibration menu, the analyzer automatically proposes the previous calibration method. If you do not want to calibrate, press the "Return" softkey or the <b>meas</b> key.</p> <p><b>During calibration the module is in function check (HOLD) mode.</b> Current outputs and relay contacts of the module behave as configured (Module BASE).</p>

# Calibration / Adjustment

## Calimatic automatic buffer recognition

### Automatic Buffer Recognition (Calimatic)

Automatic calibration using Knick Calimatic is performed with one, two, or three buffer solutions. Protos automatically detects the nominal buffer value on the basis of the electrode potential and the measured temperature. Any sequence of buffer solutions is possible, but they must belong to the buffer set defined during parameter setting.

The Calimatic takes the temperature dependence of the buffer value into account. All calibration data is converted using a reference temperature of 25 °C/77 °F.

### During calibration the module is in function check (HOLD) mode.

Current outputs and relay contacts of the module behave as configured (Module BASE).



### NOTICE!

Only ever use fresh, undiluted buffer solutions which belong to the selected buffer set!

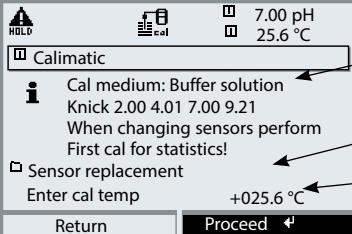
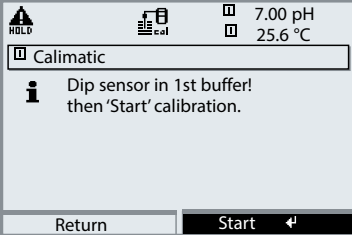
Note: The display may vary depending on the device version.

Menu	Display	Automatic buffer recognition
		<p><b>Select: Calimatic</b></p> <p>Display of selected buffer set</p> <p>Select: Sensor replacement</p> <p>Enter: calibration temp</p> <p>Proceed by pressing softkey or <b>enter</b>.</p>
		<p>Remove and rinse the electrode (<b>CAUTION:</b> Electrostatic hazard. Do not rub.), then immerse it in the first buffer solution.</p> <p>Start by pressing softkey or <b>enter</b>.</p>

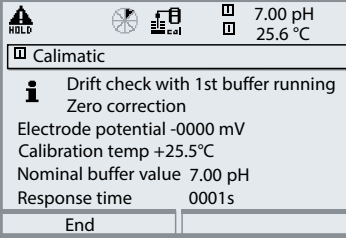
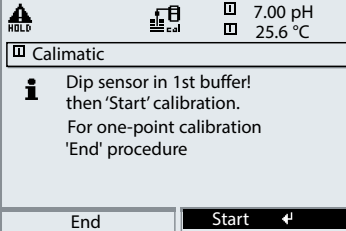
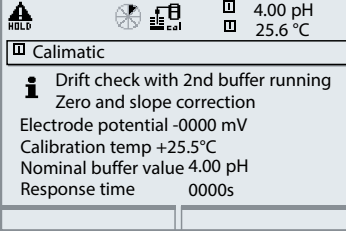
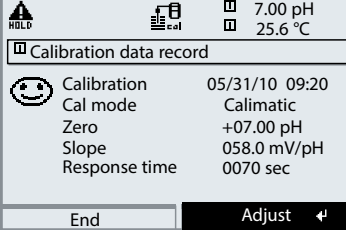
Note: The display may vary depending on the device version.

Menu	Display	Automatic buffer recognition
	 <p>Calimatic</p> <p><b>i</b> Drift check with 1st buffer running Zero correction Electrode potential -0000 mV Calibration temp +25.5°C Nominal buffer value 7.00 pH Response time 0001s</p> <p>End</p>	<p>Display of nominal buffer value. You can press "End" to reduce the waiting time before stabilization of the electrode potential (reduced accuracy of calibration values). From the response time, you see how much time the electrode needs for the potential to stabilize. If the electrode potential or the measured temperature fluctuate greatly, the calibration procedure is aborted after 2 min.</p>
	 <p>Calimatic</p> <p><b>i</b> Dip sensor in 1st buffer! then 'Start' calibration. For one-point calibration 'End' procedure</p> <p>End      Start ↵</p>	<p>For a one-point calibration, press "End" softkey. For two-point calibration: Rinse electrode thoroughly! Immerse electrode in the second buffer solution. Start by pressing softkey or <b>enter</b></p>
	 <p>Calimatic</p> <p><b>i</b> Drift check with 2nd buffer running Zero and slope correction Electrode potential -0000 mV Calibration temp +25.5°C Nominal buffer value 4.00 pH Response time 0000s</p>	<p>Calibration is performed with the second buffer.  Three-point calibration is performed correspondingly with the third buffer.</p>
	 <p>Calibration data record</p> <p> Calibration 05/31/10 09:20 Cal mode Calimatic Zero +07.00 pH Slope 058.0 mV/pH Response time 0070 sec</p> <p>End      Adjust ↵</p>	<p><b>Adjustment</b> Press "Adjust" to take over the values determined during calibration for calculating the measured variables.</p>

# Calibration / Adjustment

Calibration with manual entry of buffer values

## Calibration with Manual Entry of Buffer Values

Calibration with manual entry of buffer values is performed with one, two or three buffer solutions.

Protos displays the measured temperature.

You must then enter the temperature-corrected buffer values. To do so, refer to the buffer table (e.g. on the bottle) and enter the buffer value belonging to the displayed temperature.

Intermediate values must be interpolated.

All calibration data is converted using a reference temperature of 25 °C/77 °F.











### During calibration the module is in function check (HOLD) mode.

Current outputs and relay contacts of the module behave as configured (Module BASE).

### NOTICE!

Only ever use fresh, undiluted buffer solutions!

Note: The display may vary depending on the device version.

Menu	Display	Manual entry
	   7.00 pH  25.6 °C Manual entry  Cal medium: Buffer solution When changing sensors perform First cal for statistics! Sensor replacement Cal temp +025.6 °C First buffer solution +04.00 pH Return Proceed ↵	<b>Select: Manual entry</b>  Select: Sensor replacement Display: calibration temp Enter first buffer value Proceed by pressing softkey or <b>enter</b>
	   7.00 pH  25.6 °C Manual entry  Dip sensor in 1st buffer! then 'Start' calibration. Return Start ↵	Remove and rinse the electrode <b>(CAUTION: Electrostatic hazard.</b> Do not rub.), then immerse it in the first buffer solution. Start by pressing softkey or <b>enter</b> .

Note: The display may vary depending on the device version.

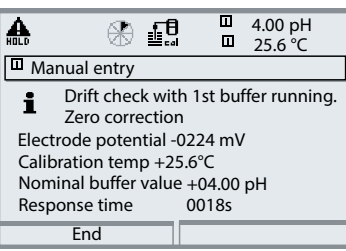
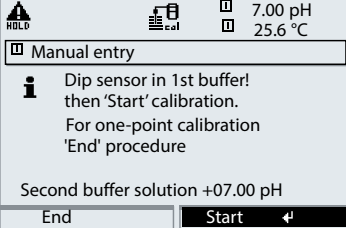
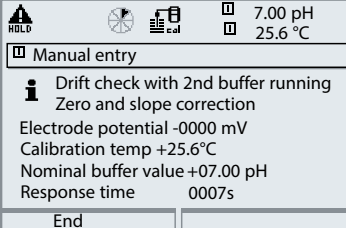
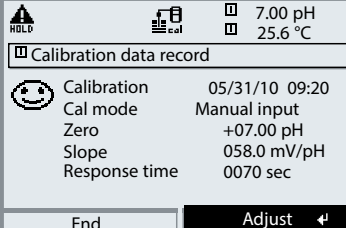
Menu	Display	Manual entry
		<p>Calibration with first buffer solution. You can press “End” to reduce the waiting time before stabilization of the electrode potential (reduced accuracy of calibration values). From the response time, you see how much time the electrode needs for the potential to stabilize. If the electrode potential or the measured temperature fluctuate greatly, the calibration procedure is aborted after 2 min.</p>
		<p>One-point calibration: “End”. Two-point calibration: Rinse electrode thoroughly! Enter 2nd buffer value for correct temperature. Immerse electrode in the second buffer solution. Start by pressing softkey or <b>enter</b></p>
		<p>Calibration is performed with the second buffer.  Three-point calibration is performed correspondingly with the third buffer.</p>
		<p><b>Adjustment</b> Press “Adjust” to take over the values determined during calibration for calculating the measured variables.</p>

# Calibration / Adjustment

## Product calibration

### Product Calibration (Calibration with Sampling)

When the electrode cannot be removed – e.g. for sterility reasons – its zero point can be determined with “sampling”. To do so, the currently measured process value is stored by the Protos. Immediately afterwards, you take a sample from the process. The pH value of the sample is measured in the lab or directly on the site using a portable pH meter. The reference value is entered into the measuring system. From the difference between measured value and reference value, the Protos calculates the electrode zero point (this method only allows one-point calibration).

**During calibration the module is in function check (HOLD) mode.** Current outputs and relay contacts of the module behave as configured (BASE).

**NOTICE!** The pH value of the sample is temperature-dependent. Therefore, the reference measurement should be performed at the sample temperature shown in the display. Transport the sample in an insulated container. The pH value may also be altered due to escaping of volatile substances.

Note: The display may vary depending on the device version.

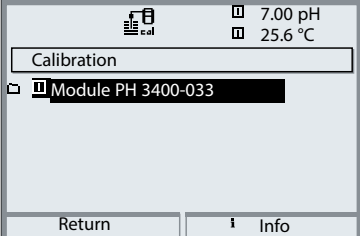
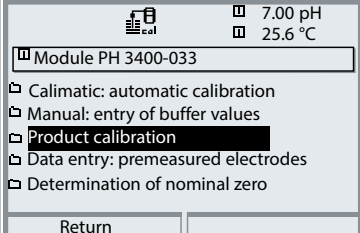
Menu	Display	Product calibration
		<p><b>Select module: PH 3400-033</b></p> <p>The module is in function check (HOLD) mode. The assigned current outputs and relay contacts behave as configured (BASE). Press <b>enter</b> to confirm.</p>
		<p>Select calibration mode “Product calibration”</p> <p>Press <b>enter</b> to confirm.</p>

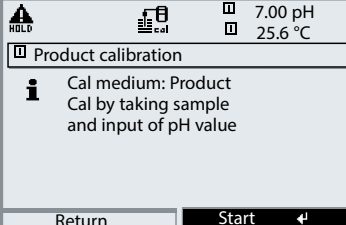
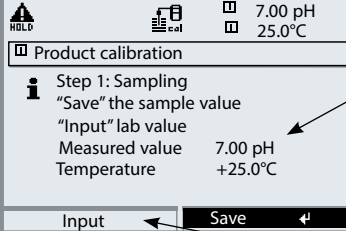
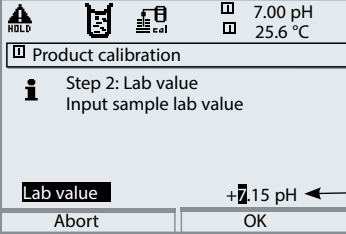
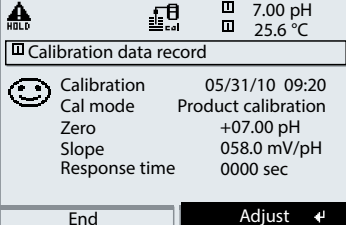

Note: The display may vary depending on the device version.

Menu	Display	Product calibration
	 <p>Product calibration</p> <p>Cal medium: Product Cal by taking sample and input of pH value</p> <p>Return      Start</p>	<p><b>Product calibration</b></p> <p>Product calibration is performed in 2 steps. Prepare sampling, start by pressing softkey or <b>enter</b>.</p>
	 <p>Step 1: Sampling "Save" the sample value "Input" lab value Measured value    7.00 pH Temperature        +25.0°C</p> <p>Input      Save</p>	<p><b>Step 1</b></p> <p>Take sample. Save measured value and temperature at the moment of sampling ("Save" softkey or <b>enter</b>). Press <b>meas</b> to return to measurement.</p> <p><b>Exception:</b> Sample value can be measured on the site and be entered immediately. To do so, press "Input" softkey.</p>
	 <p>Step 2: Lab value Input sample lab value</p> <p>Lab value            +7.15 pH</p> <p>Abort      OK</p>	<p><b>Step 2</b></p> <p>Lab value has been measured. When you open the Product calibration menu again, the display shown on the left appears: Enter reference value ("Lab value"). Confirm with OK or repeat calibration.</p>
	 <p>Calibration data record</p> <p>Calibration        05/31/10 09:20 Cal mode        Product calibration Zero                +07.00 pH Slope              058.0 mV/pH Response time    0000 sec</p> <p>End      Adjust</p>	<p><b>Adjustment</b></p> <p>Press "Adjust" to take over the values determined during calibration for calculating the measured variables.</p>

# Calibration / Adjustment

Calibration by entering data from premeasured electrodes

## Data Entry of Premeasured Electrodes

Entry of values for zero point, slope and isothermal potential of a pH electrode. The values must be known, e.g. determined beforehand in the laboratory.

**NOTICE!** Input of an isothermal potential  $V_{iso}$  also applies to the calibration methods

- Calimatic
- Manual input
- Product calibration

For an explanation of the isothermal potential, refer to Pg 27.

**During calibration the module is in function check (HOLD) mode.** Current outputs and relay contacts of the module behave as configured (BASE).

Menu	Display	Data entry						
	<div style="border: 1px solid black; padding: 5px;"> <div style="display: flex; justify-content: space-between; align-items: center;"> <span>⚠ HOLD</span> <span>📊 cal</span> <span>7.00 pH 25.6°C</span> </div> <hr/> <p>☐ Data entry</p> <p><b>i</b> When changing sensors perform First cal for statistics!</p> <p>☐ Sensor replacement</p> <table style="width: 100%; border-collapse: collapse;"> <tr> <td style="width: 70%;">Zero</td> <td style="text-align: right;">+07.00pH</td> </tr> <tr> <td>Slope</td> <td style="text-align: right;">058.0 mV/pH</td> </tr> <tr> <td>Isothermal potential</td> <td style="text-align: right;">+0000 mV</td> </tr> </table> <div style="border-top: 1px solid black; padding-top: 5px;"> <span style="float: left;">Return</span> </div> </div>	Zero	+07.00pH	Slope	058.0 mV/pH	Isothermal potential	+0000 mV	<p><b>Select: Data entry of premeasured electrodes</b></p> <p>Remove electrode and connect premeasured electrode. Open "Sensor replacement". Enter the values for</p> <ul style="list-style-type: none"> <li>• Zero</li> <li>• Slope</li> <li>• Isothermal potential</li> </ul> <p>Return using softkey or press <b>meas</b> to return to measurement.</p>
Zero	+07.00pH							
Slope	058.0 mV/pH							
Isothermal potential	+0000 mV							

**Note:** The display may vary depending on the device version.

## Isothermal potential

The isothermal intersection point is the point of intersection between two calibration lines at two different temperatures. The potential difference between the electrode zero point and this intersection point is the isothermal potential "Viso".

It may cause measurement errors depending on the temperature. These errors can be compensated for by defining the "Viso" value.

- Measurement errors are avoided by calibrating at measuring temperature or at a controlled and stable temperature.

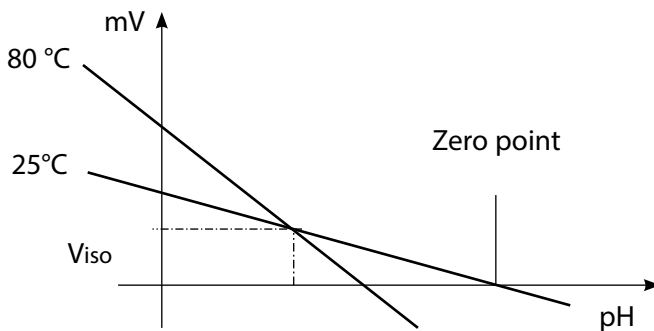

## Monitoring functions for calibration

Protos provides comprehensive functions for monitoring proper calibration performance and the electrode condition. This allows documentation for quality management to ISO 9000 and GLP/GMP.

- Sensocheck monitors the electrode condition by measuring the glass and reference electrode impedances.
- Regular calibration can be monitored by the cal timer.
- Adaptive cal timer - automatically reduces the calibration interval when the electrode is subjected to high stress
- The calibration record (GLP/GMP) provides all relevant data of the last calibration and adjustment.
- The statistics show the behavior of the electrode parameters during the last three calibrations compared to the First Calibration.
- The logbook shows the time and date of a performed calibration.

# Calibration / Adjustment

Determination of nominal zero

## NOTICE!

After having determined the nominal zero point of a Pfaudler probe, it is absolutely necessary to perform a two-point calibration/adjustment!

### Determination of Nominal Zero

Every Pfaudler probe has a different, individual zero point.

Depending on the probe variant, it lies near:

Pfaudler standard probes +01.50 pH

Pfaudler differential probes +10.00 pH

When selecting the corresponding Pfaudler probe during parameter setting, the values listed above are taken as default setting.





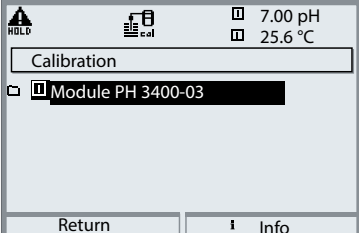
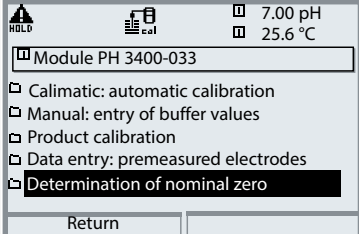

For correct measurement, however, you must enter the correct, individual zero point of your Pfaudler probe.

**During calibration the module is in function check (HOLD) mode.** Current outputs and relay contacts of the module behave as configured (BASE).

Note: The display may vary depending on the device version.

Menu	Display	Product calibration
		<p><b>Select module: PH 3400-033</b></p> <p>The module is in function check (HOLD) mode. The assigned current outputs and relay contacts behave as configured (BASE). Press <b>enter</b> to confirm.</p>
		<p>Select calibration mode "Determination of nominal zero"</p> <p>Press <b>enter</b> to confirm.</p>

Note: The display may vary depending on the device version.

Menu	Display	Determination of nominal zero
 cal	<div data-bbox="179 239 532 478"><span data-bbox="397 247 498 287">7.00 pH 25.6 °C</span><p data-bbox="184 287 526 311">Determination of nominal zero</p><p data-bbox="201 319 509 406"><b>i</b> Dip sensor in buffer solution! Enter temperature-corrected pH value in the range 6.5 ... 7.5 pH. then "Start" calibration.</p><p data-bbox="196 406 504 446">Enter cal temp           +25.0°C Buffer                    +07.00 pH</p><p data-bbox="229 454 532 478">Return                   <b>Start</b> ↵</p></div> <div data-bbox="179 486 532 726"><span data-bbox="397 494 498 534">7.00 pH 25.0°C</span><p data-bbox="184 534 526 558">Determination of nominal zero</p><p data-bbox="201 566 526 694"><b>i</b> Drift check running Zero correction Electrode voltage       -0 mV Cal temperature        +25.0°C Nominal buffer value   +07.00 pH Response time           8 sec</p><p data-bbox="240 702 532 726">End</p></div> <div data-bbox="179 774 532 1013"><span data-bbox="397 782 498 821">7.00 pH 25.6 °C</span><p data-bbox="184 821 526 845">Determination of nominal zero</p><p data-bbox="201 853 520 893"><b>i</b> Nominal zero           +10.35 pH</p><p data-bbox="184 989 532 1013"><b>Return</b> ↵</p></div>	<p data-bbox="560 239 991 414"><b>Determination of nominal zero</b> Dip sensor in buffer solution. Enter temperature-corrected pH in the range pH 6.5...7.5. Start by pressing softkey or <b>enter</b>.</p> <p data-bbox="560 502 1024 917"><b>Calibration with buffer solution.</b> You can press "End" to reduce the waiting time before stabilization of the electrode potential (reduced accuracy of calibration values). From the response time, you see how much time the electrode needs for the measured value to stabilize. If the electrode potential or the measured temperature fluctuate greatly, the calibration procedure is aborted after 2 min.</p>

# Calibration / Adjustment

---

## Temp Probe Adjustment

**Note:** With Protos II 4400(X) in the Calibration menu,  
with Protos 3400(X) in the Maintenance menu.

### **Temp Probe Adjustment**

This function allows compensating for the individual temperature probe tolerance and the influence of the lead resistances to increase the accuracy of temperature measurement. Make sure that the process temperature is precisely measured using a calibrated reference thermometer when performing an adjustment. The measurement error of the reference thermometer should be less than 0.1 °C. Adjustment without precise measurement might result in considerable deviations of the measured value display!

# Parameter Setting

---

## ⚠ CAUTION!

Incorrect parameter setting, calibration or adjustment may result in incorrect measurements being recorded. Protos must therefore be commissioned by a system specialist, all its parameters must be set, and it must be fully adjusted.

## NOTICE!

The "function check" (HOLD) mode is active during parameter setting. The behavior of the current outputs depends on the parameter setting, i.e., they may be frozen at the last measurement or set to a fixed value. The red "Alarm" LED blinks.

Measurement operations must not be carried out while the Protos is in the function check (HOLD) mode, as this may put the user at risk due to unexpected system behavior.

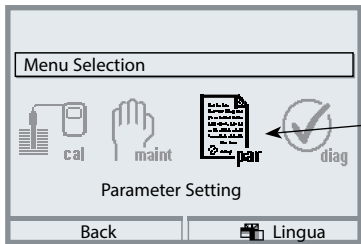
Menu	Display	Action
		<b>Open the Parameter Setting menu</b> From the measuring mode: Press <b>menu</b> key to select menu. Select parameter setting using arrow keys, press <b>enter</b> to confirm

# Parameter Setting: Operating Levels

Viewing level, Operator level, Administrator level

**Note:** Function check (HOLD) mode active (Setting: BASE module)

Note: The display may vary depending on the device version.

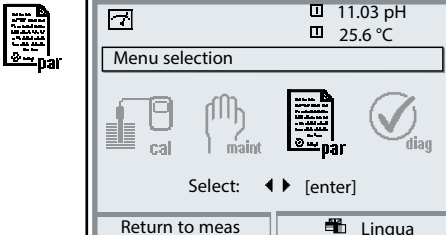
Menu	Display	Viewing level, Operator level, Administrator level
	<p>11.03 pH 25.6 °C</p> <p>Menu selection</p> <p>cal maint par diag</p> <p>Select: [left] [right] [enter]</p> <p>Return to meas Lingua</p>	<p><b>Open parameter setting</b></p> <p>From the measuring mode: Press <b>menu</b> key to select menu. Select parameter setting using arrow keys, press <b>enter</b> to confirm.</p>
	<p>11.03 pH 25.6 °C</p> <p>Parameter setting</p> <p>Viewing level (All Data) view Operator level (Operation Data) opl Administrator level (All Data) adm</p> <p>Return</p>	<p><b>Administrator level</b></p> <p>Access to all functions, also passcode setting. Releasing or blocking a function for access from the Operator level.</p>
	<p>HOLD 11.03 pH 25.6 °C</p> <p>Module FRONT (Administrator)</p> <p>Languages English Measurement display Measurement recorder KI recorder</p> <p>Return Release</p>	<p>Functions which can be blocked for the Operator level are marked with the "lock" symbol. The functions are released or blocked using the softkey.</p>
	<p>HOLD 11.03 pH 25.6 °C</p> <p>Module FRONT</p> <p>Languages English Measurement display Measurement recorder KI recorder</p> <p>Return</p>	<p><b>Operator level</b></p> <p>Access to all functions which have been released at the Administrator level. Blocked functions are displayed in gray and cannot be edited (Fig.).</p> <p><b>Viewing level</b></p> <p>Display of all settings. No editing possible!</p>





# Parameter Setting: Locking a Function

Administrator level: Enabling/locking functions for Operator level

**Note:** Function check (HOLD) mode active (Setting: BASE module)

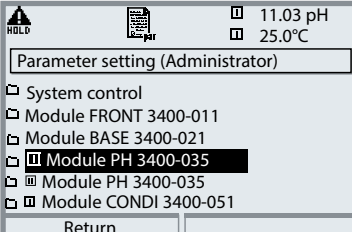
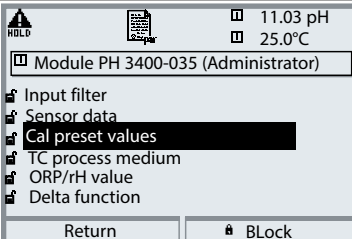
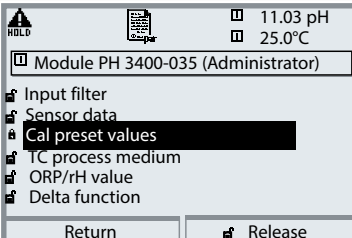
**Note:** The display may vary depending on the device version.

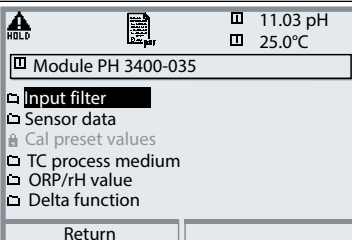
Menu	Display	Administrator level: Enable / lock functions
		<p><b>Example:</b> Blocking access to the calibration adjustments from the Operator level</p> <p><b>Open parameter setting</b> Select Administrator level. Enter passcode (1989). Select “Module PH” (e.g.) using arrow keys, press <b>enter</b> to confirm.</p>
		<p>Select “Cal preset values” using arrow keys. “Block” with softkey.</p>
		<p>Now, the “Cal preset values” line is marked with the “lock” icon. This function cannot be accessed from the Operator level any more. The softkey function changes to “Release”.</p>
		<p><b>Open parameter setting</b> Select <u>Operator level</u>, passcode (1246). Select “Module PH”. Now, the locked function is displayed in gray and marked with the “lock” icon.</p>

# Activating Parameter Setting

Note: The display may vary depending on the device version.

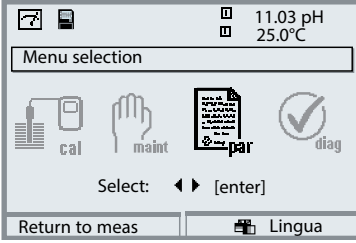
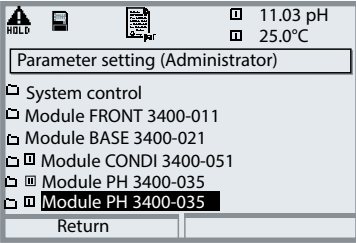
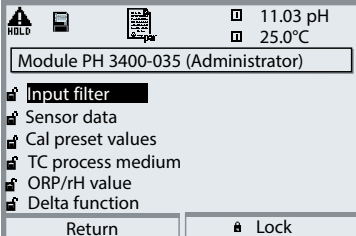
Menu	Display	Parameter setting
		<p><b>Activating parameter setting</b>            From the measuring mode:            Press <b>menu</b> key to select menu.            Select parameter setting using arrow keys, press <b>enter</b> to confirm.            Passcode as delivered: 1989</p>
		<p>Select module,            press <b>enter</b> to confirm.</p> <p>(In the Figure, the "Module PH" is selected, for example.)</p>
		<p>Select parameter using arrow keys,            press <b>enter</b> to confirm.</p>

**During parameter setting the analyzer is in function check (HOLD) mode:**  
 Current outputs and relay contacts behave as configured (BASE module).



# Parameter Setting

Sensor data. pH sensor monitoring adjustable

**Note:** Function check (HOLD) mode active

Note: The display may vary depending on the device version.

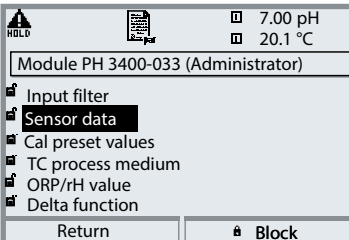
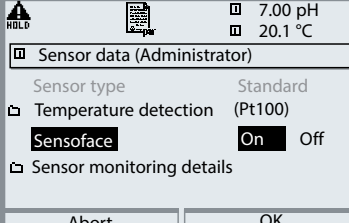
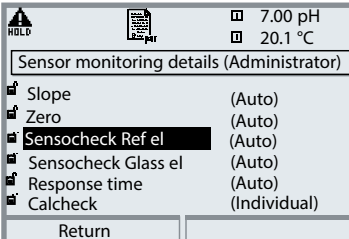
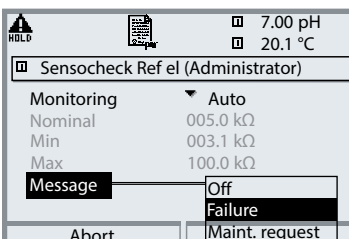
Menu	Display	Parameter selection
		<p><b>Sensor data</b></p> <p>Sensor data are preset depending on the sensor type. Gray display lines cannot be edited.</p>
		<p><b>Sensoface</b> provides information on the sensor condition (evaluating the sensor data). Great deviations are signaled. Sensoface can be switched off.</p>
		<p><b>Sensor monitoring details</b></p> <p>The following parameters are monitored: Slope, zero, reference impedance, glass impedance (pH electrodes), response time. For "Auto", the tolerance limits are displayed in gray. For "Individual", the settings can be specified by the user.</p>
		<p><b>Message</b></p> <p>A message can be output as "Failure" (Module BASE, Contact K4) or "Maintenance request" (Module BASE, Contact K3). <b>(NOTICE! Set contact parameters!)</b></p>

Sensoface is a graphic indication of the sensor condition.

The “smileys” provide information on wear and required maintenance of the sensor (“friendly” - “neutral” - “sad”).

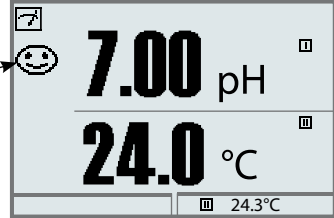

## Sensocheck

Automatic monitoring of glass and reference electrode

**Note:** The display may vary depending on the device version.

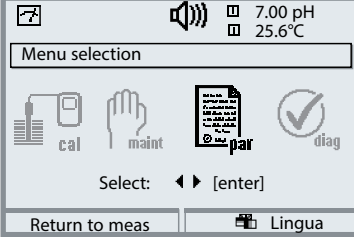
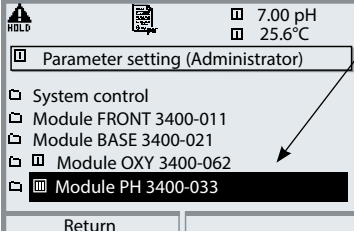
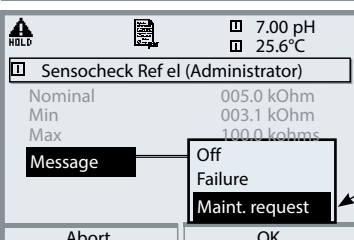
Menu	Display	Activate Sensocheck
	  	<p><b>Open menu selection</b>            Select parameter setting            Enter passcode (Administrator)</p> <p>Select module (“PH”).            Confirm with <b>enter</b></p> <p>Select “Sensor data”.            Confirm with <b>enter</b>.            Then select “Sensocheck Ref el”.            (Fig.)            Assign function and            confirm with <b>enter</b>.</p>

# Sensoface is “sad” ...

The “Diagnostics / Module PH / Sensor network diagram” shows all current sensor parameters in a graphic diagram.

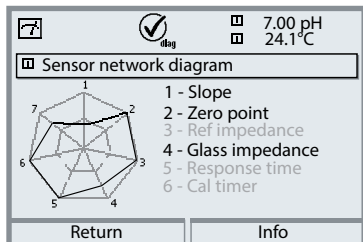

## Sensor diagram

“Diagnostics / Module PH / Sensor network diagram”.

Tolerance limit violations can be seen at a glance. Critical parameters (inner circle) are flashing. Parameters displayed in gray have been disabled during parameter setting or do not apply to the currently selected sensor.

## Sensoface criteria

Parameter	Standard*	Critical range
Slope	59.2	< 53.3 or > 61
Zero	7.00	< 6.00 or > 8.00
Reference impedance	Rcal **	< 0.6 Rcal or > 100 kΩ+ 0.5 Rcal
Glass impedance	Rcal **	< 0.3 Rcal or > 3.5 Rcal
Response time Fine Standard Coarse		120 sec 80 sec 60 sec
Calibration timer		when 80 % expired
Calcheck		Difference meas. value / buffer > 3.2 pH

\* Applies to standard electrodes with pH = 7.00

\*\* Rcal is determined during calibration

# Parameter Setting

Cal preset values

**Note:** Function check (HOLD) mode active

Parameter	Default	Selection / Range
<b>Cal preset values</b> • Calimatic buffer	Knick CaliMat	Knick CaliMat: 2.00 4.00 7.00 9.00 12.00 (Merck/Riedel: 2.00 4.00 7.00 9.00 12.00) Mettler-Toledo: 2.00 4.01 7.00 9.21 DIN 19267: 1.09 4.65 6.79 9.23 12.75 NIST Standard: 4.006 6.865 9.180 NIST Technical: 1.68 4.00 7.00 10.01 12.46 Hamilton: 2.00 4.01 7.00 10.01 12.00 Kraft: 2.00 4.00 7.00 9.00 11.00 Hamilton A: 2.00 4.01 7.00 9.00 11.00 Hamilton B: 2.00 4.01 6.00 9.00 11.00 HACH: 4.01 7.00 10.00 Ciba: 2.06 4.00 7.00 10.00 Reagecon: 2.00 4.00 7.00 9.00 12.00 Table
• Drift check	Standard	Fine: 1.2 mV/min (Abort after 180 sec) Standard: 2.4 mV/min (Abort after 120 sec) Coarse: 3.75 mV/min (Abort after 90 sec)
• Cal timer Monitoring Calibration timer Adaptive cal timer	Auto 0000h (Off) Off	Auto Off, entry Off, On
• Tolerance band check (SW 3400-005/FW 4400-005)	Off	Tolerance adjustment: Off, On Tolerance band zero +00.20 pH (entry) Tolerance band slope +002.0 mV/pH (entry)

**Note:** The menus may vary depending on the device version

## Tolerance adjustment

(add-on function SW3400-005 / FW4400-005<sup>1)</sup>)

During calibration this function checks the zero and slope values and automatically performs an adjustment when the tolerance band is exceeded.

The parameters are stored in the tolerance band recorder (Diagnostics menu).

The add-on function SW3400-005 / FW4400-005 is device-specific. When ordering this function, you therefore have to specify the serial number of your FRONT module in addition to the respective order number.

(The FRONT module contains the Protos system control).

The manufacturer then supplies a TAN (transaction number) to release the add-on function in the system control menu.

1) Protos II 4400(X): FW4400-005 only available from FRONT firmware version 02.xx.xx

# Tolerance Adjustment (SW3400-005 / FW4400-005)<sup>1)</sup>

## Program flow

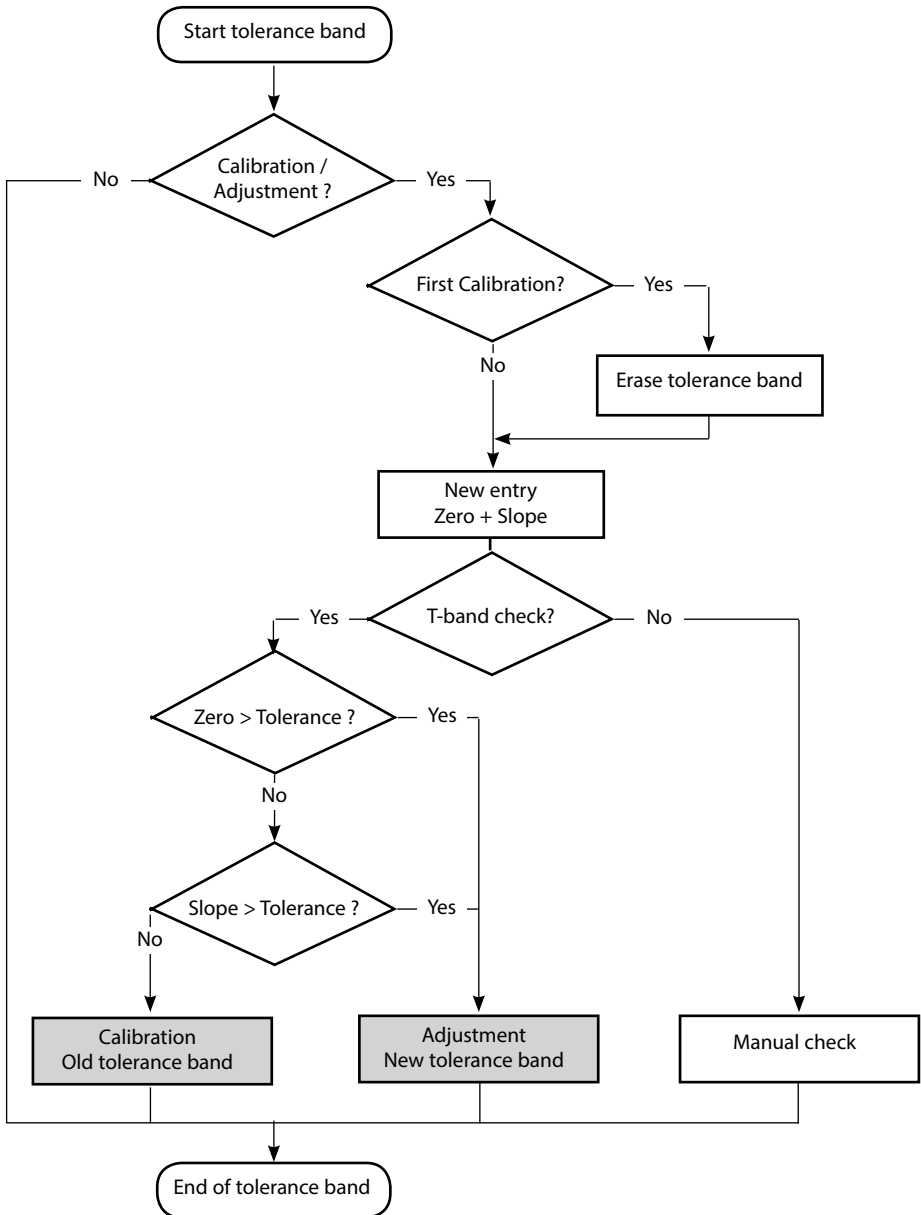



# Activating the Tolerance Adjustment

Select menu: Parameter setting/System control/Release of options

**Note:** The TAN for releasing an add-on function is only valid for the device with the corresponding serial number!

**Note:** The display may vary depending on the device version.

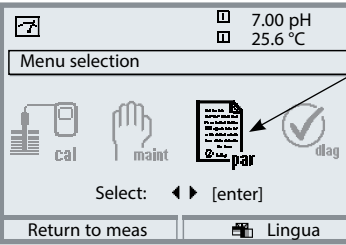
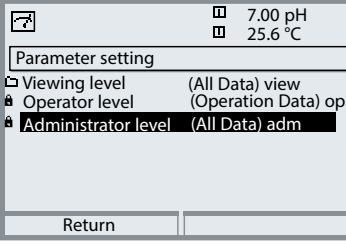
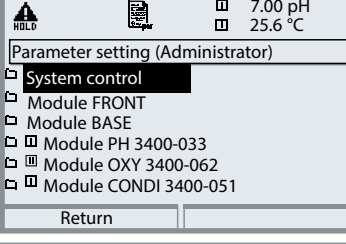
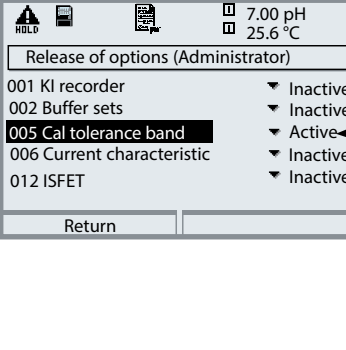
Menu	Display	Activating an additional function
		<p><b>Menu selection</b></p> <p>Open parameter setting. From the measuring mode: Press <b>menu</b> key to select menu. Select parameter setting using arrow keys, confirm with <b>enter</b>.</p>
		<p><b>Parameter setting</b></p> <p>Select Administrator level using arrow keys, confirm with <b>enter</b>. Enter passcode and confirm (Passcode as delivered: 1989).</p>
		<p>Select system control using arrow keys, confirm with <b>enter</b>. Then select Release of options using arrow keys, confirm with <b>enter</b>.</p>
		<p><b>Release of options</b></p> <p>Select the additional function to be released ("Cal tolerance band"). Set option to "active". Enter the TAN at the prompt. (Note: The TAN is only valid for the device with the corresponding serial number, see page 39.) The option is available after the TAN has been entered.</p>

# Parameter Setting

Cal preset values: Calimatic buffer, Cal timer, Cal tolerance band

**Note:** Function check (HOLD) mode active

Note: The display may vary depending on the device version.

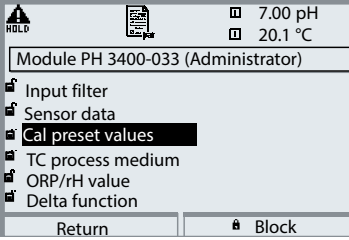
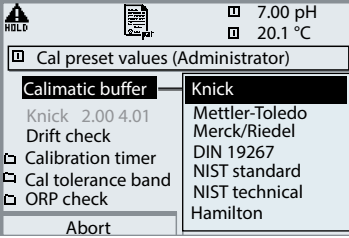
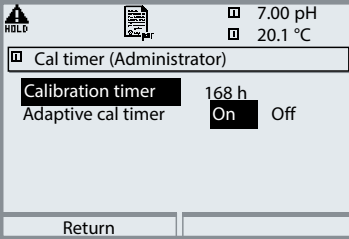
Menu	Display	Cal preset values
		<h3>Calimatic buffer</h3> <p>For automatic calibration, you must define the buffer set you want to use. For calibration, you must then use buffer solutions from this buffer set in any order.</p> <p>The selected buffer set with the nominal values of the individual buffer solutions is displayed in gray.</p> <p>The “Calimatic buffer” menu shows all buffer sets available.</p> <p>Select buffer set with <b>enter</b>.</p>
		<h3>Calibration timer</h3> <p>Entry of the time interval until the next due calibration.</p> <h3>Adaptive cal timer</h3> <p>Automatically reduces the time until the next due calibration when the electrode is exposed to high stress (temperature, extreme pH values).</p>
		<h3>Cal tolerance band</h3> <p>If the measured value leaves the tolerance band specified here for zero and slope, an adjustment is automatically performed during calibration.</p>

# Parameter Setting

Default settings and selection range

**Note:** Function check (HOLD) mode active

**Note:** The menus may vary depending on the device version.

Parameter	Default	Selection / Range
<b>TC process medium</b> • TC correction	Off	Off, linear, ultrapure water, table Linear: enter temperature factor +XX.XX %/K
<b>ORP/rH value</b> • Reference electrode  • ORP conversion to SHE • Calculate rH with factor	Ag/AgCl,KCl 1mol/l  No No	Ag/AgCl,KCl 3mol/l Hg, Tl/TlCl, KCl 3.3 mol/l Hg/Hg <sub>2</sub> SO <sub>4</sub> , K <sub>2</sub> SO <sub>4</sub> sat No, Yes No, Yes, entry of factor
<b>Delta function</b> • Delta function	Off	Off, pH, mV+ORP or rH: entry of delta value

# Parameter Setting

TC process medium

**Note:** Function check (HOLD) mode active

Note: The display may vary depending on the device version.

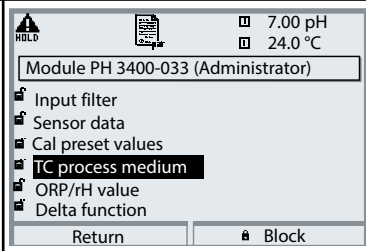
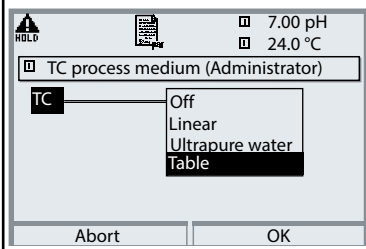
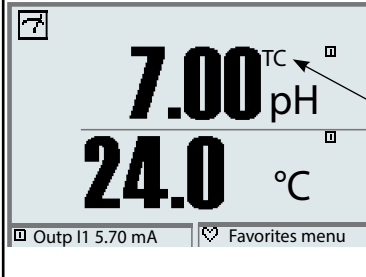
Menu	Display	TC process medium (Parameter selection Pg 43)
		<p><b>TC process medium</b></p> <p>You can choose from:</p> <ul style="list-style-type: none"> <li>• Linear (entry of TC coefficient)</li> <li>• Ultrapure water</li> <li>• Table</li> </ul> <p>When measuring media with a known temperature behavior, the output pH value can be corrected using a table. TC can be entered in 5 °C steps for temperatures between 0 and +95 °C. Then, the output pH value is corrected by the corresponding TC value depending on the measuring temperature. Intermediate values are linearly interpolated. In the case of lower or higher temperatures (&lt; 0 °C or &gt; +95 °C), the last table value is used for calculation.</p> <p>If the delta function has been activated (see Pg 43) simultaneously with temperature compensation, the temperature is compensated first and then the delta value is subtracted.</p>
		<p>When the TC correction for process medium is switched on, "TC" appears in the display in measuring mode.</p>

# Parameter Setting

---

TC process medium – Linear temperature compensation of process medium

## Temperature Compensation of Process Medium

Linear temperature compensation, reference temp fixed at 25 °C

$$\text{pH}_{(25\text{ °C})} = \text{pH}_M + \text{TC}/100 \% (25\text{ °C} - T_M)$$

$$\text{pH}_{(25\text{ °C})} = \text{pH value compensated to } 25\text{ °C}$$

$$\text{pH}_M = \text{Measured pH value (temperature-corrected)}$$

$$\text{TC} = \text{Temperature factor } [\%/K]$$

$$T_M = \text{Measured temperature } [^\circ\text{C}]$$

# Parameter Setting

ORP/rH value, delta function

**Note:** Function check (HOLD) mode active

Note: The display may vary depending on the device version.

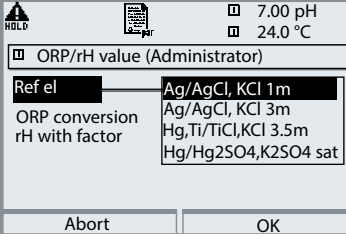
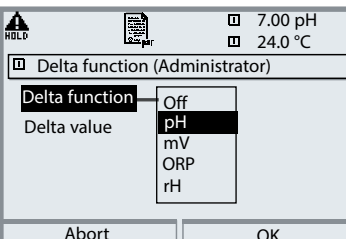
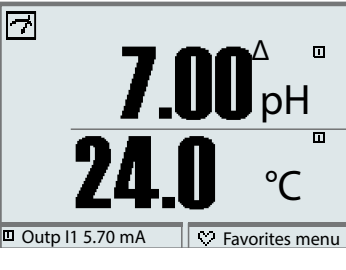
Menu	Display	ORP/rH value, delta function (selection Pg 43)
	 <p>7.00 pH 24.0 °C</p> <p>ORP/rH value (Administrator)</p> <p>Ref el: Ag/AgCl, KCl 1m ORP conversion: Ag/AgCl, KCl 3m rH with factor: Hg, Ti/TiCl, KCl 3.5m Hg/Hg2SO4, K2SO4 sat</p> <p>Abort OK</p>  <p>7.00 pH 24.0 °C</p> <p>Delta function (Administrator)</p> <p>Delta function: Off Delta value: pH mV ORP rH</p> <p>Abort OK</p>  <p>7.00<sup>Δ</sup> pH 24.0 °C</p> <p>Outp I1 5.70 mA Favorites menu</p>	<p><b>ORP/rH value</b></p> <ul style="list-style-type: none"> <li>Select type of reference electrode:           <ul style="list-style-type: none"> <li>Ag/AgCl, KCl 1 mol/l (silver/silver chloride)</li> <li>Ag/AgCl, KCl 3 mol/l (silver/silver chloride)</li> <li>Hg, Ti/TiCl, KCl 3.3 mol/l (Thalamid)</li> <li>Hg/Hg<sub>2</sub>SO<sub>4</sub>, K<sub>2</sub>SO<sub>4</sub> saturated (mercury sulfate)</li> </ul> </li> <li>ORP conversion to SHE</li> <li>Calculate rH with factor</li> </ul> <p><b>Delta function</b></p> <p>When a delta value is entered, the system calculates the difference</p> <p>Output value = measured value – delta value</p> <p>The output value controls all outputs and is shown on the display. When the delta function has been activated simultaneously with temperature compensation, the temperature is compensated first and then the delta value is subtracted.</p> <p>When delta function is switched on, “Δ” appears in the display in measuring mode.</p>

# Calculation Blocks

Select menu: Parameter setting/System control/Calculation Blocks  
Calculation of new variables from measured variables

## Calculation Blocks

Two measuring modules with all their measured values serve as input for the calculation block. In addition, the general device status (NAMUR signals) is taken into account. The difference between the existing values is calculated:

### Current outputs

All current outputs can be set to output the new process variables formed by the Calculation Blocks.

### Measurement display

All new process variables can be displayed as primary or as secondary value.

### Controller

Controller functions are not supported.

## Functionality of measuring module

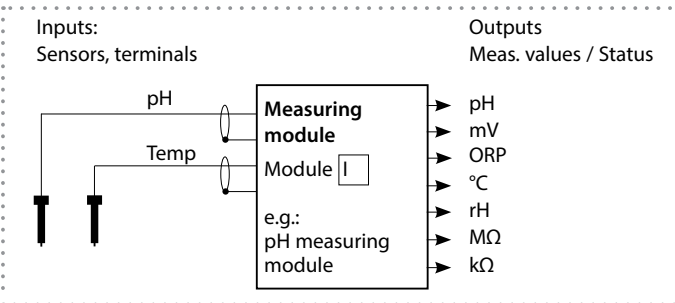

## Functionality of Calculation Block

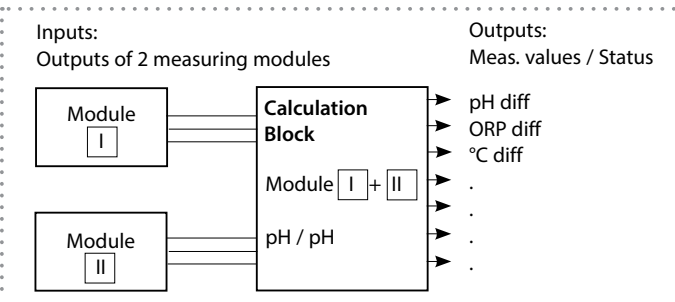

# Activating a Calculation Block

Select menu: Parameter setting/System control/Calculation Blocks

## Combining measuring modules

With three measuring modules the following Calculation Block combinations are possible:  + ,  + ,  + 

Two Calculation Blocks can be activated.

Note: The display may vary depending on the device version.

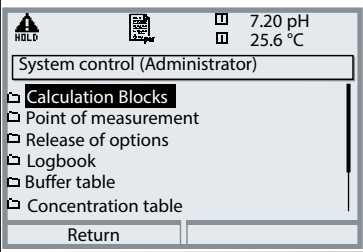
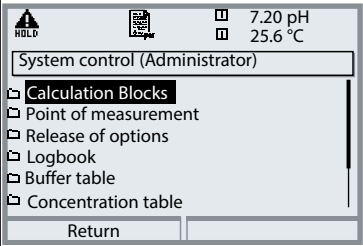
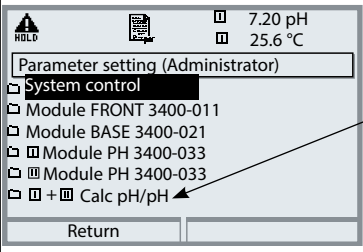
Menu	Display	Activating a Calculation Block
		<b>Calculation Blocks</b> <ul style="list-style-type: none"> <li>• Open parameter setting</li> <li>• System control</li> <li>• Select "Calculation Blocks"</li> </ul>
		<ul style="list-style-type: none"> <li>• Depending on the modules installed, the possible combinations for Calculation Blocks are offered.</li> </ul>
		<p>During parameter setting the Calculation Blocks are displayed like modules.</p>



# Configuring a Calculation Block

Select menu: Parameter setting/System control/Calculation Blocks  
 Setting the process variable to be calculated

Note: The display may vary depending on the device version.

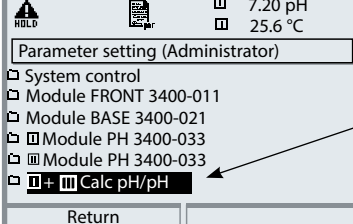
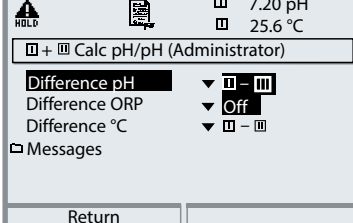
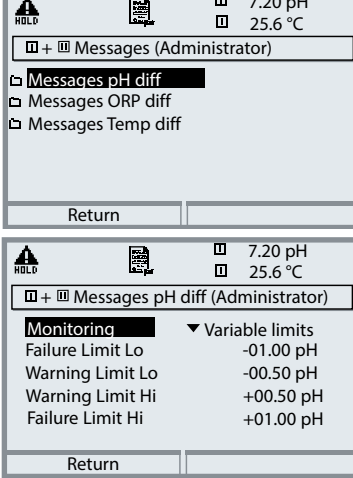
Menu	Display	Configuring a Calculation Block
		<p><b>To select a Calculation Block</b></p> <ul style="list-style-type: none"> <li>• Open parameter setting</li> <li>• System control</li> <li>• Select module</li> </ul>
		<ul style="list-style-type: none"> <li>• Depending on the modules installed, the possible combinations for Calculation Blocks are offered.</li> </ul>
		<p><b>Messages</b></p> <p>You can activate messages for the selected variables.</p> <p>Variables which have been set as "Off" cannot be processed further.</p> <p>Set the measured values which shall release a message using the arrow keys (left/right: select position, up/down: edit number) and confirm with <b>enter</b>.</p>

# Parameter Setting

Parameter setting/System control

**Note:** Function check (HOLD) mode active

Note: The display may vary depending on the device version.

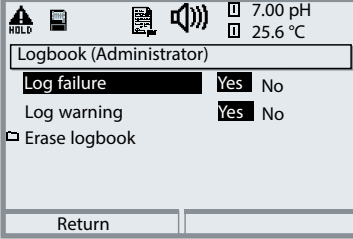
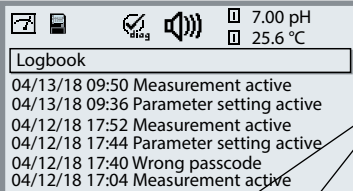
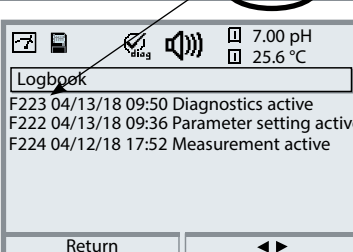
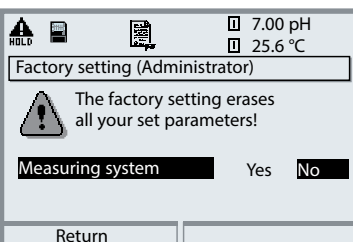
Menu	Display	Logbook, Factory setting
	 <p>Logbook (Administrator)</p> <p>Log failure <input checked="" type="checkbox"/> Yes <input type="checkbox"/> No</p> <p>Log warning <input checked="" type="checkbox"/> Yes <input type="checkbox"/> No</p> <p>Erase logbook</p> <p>Return</p>	<p><b>Logbook</b></p> <p>Select which messages are to be recorded in the logbook.</p> <p>The logbook directly displays the last events with date and time, e.g. calibrations, warning and failure messages, power failure (Protos 3400(X): 50, Protos II 4400(X): 100 events).</p>
	 <p>Logbook</p> <p>04/13/18 09:50 Measurement active</p> <p>04/13/18 09:36 Parameter setting active</p> <p>04/12/18 17:52 Measurement active</p> <p>04/12/18 17:44 Parameter setting active</p> <p>04/12/18 17:40 Wrong passcode</p> <p>04/12/18 17:04 Measurement active</p> <p>04/12/18 16:53 Diagnostics active</p> <p>Return</p> <p>◀ ▶</p>	<p>The logbook entries can be called from the Diagnostics menu (Fig.). Pressing the right softkey displays the message identifier.</p>
	 <p>Logbook</p> <p>F223 04/13/18 09:50 Diagnostics active</p> <p>F222 04/13/18 09:36 Parameter setting active</p> <p>F224 04/12/18 17:52 Measurement active</p> <p>Return</p> <p>◀ ▶</p>	<p>SW3400-104: Extended logbook / FW4400-104: Logbook</p> <p>With SmartMedia Card and Protos 3400(X) or Data Card and Protos II 4400(X), max. 50,000 entries (Protos 3400(X)) or min. 20,000 entries (Protos II 4400(X)) can be saved on a memory card.</p>
	 <p>Factory setting (Administrator)</p> <p>The factory setting erases all your set parameters!</p> <p>Measuring system <input checked="" type="checkbox"/> Yes <input type="checkbox"/> No</p> <p>Return</p>	<p><b>Restore Factory Settings</b></p> <p>Allows resetting the parameters to their factory setting.</p>

# Parameter Setting

Messages: Default settings and selection range

**Note:** Function check (HOLD) mode active

Parameter	Default	Selection / Range
<b>Messages</b> <ul style="list-style-type: none"> <li>• pH value</li> <li>• ORP value</li> <li>• rH value</li> <li>• Temperature</li> <li>• mV value</li> </ul>	Limits max Off Off Limits max Off	Off, device limits max., variable limits* Off, device limits max., variable limits* Off, device limits max., variable limits* Off, device limits max., variable limits* Off, device limits max., variable limits*  * With "Variable limits" selected, the following parameters can be edited: <ul style="list-style-type: none"> <li>• Failure Limit Lo</li> <li>• Warning Limit Lo</li> <li>• Warning Limit Hi</li> <li>• Failure Limit Hi</li> </ul>

**Note:** The menus may vary depending on the device version

## Device limits

- Max. device limits: Maximum measuring range of device
- Variable limits: Range limits specified

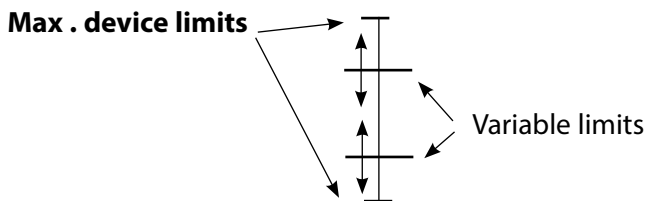





# Setting the Message Parameters

Messages

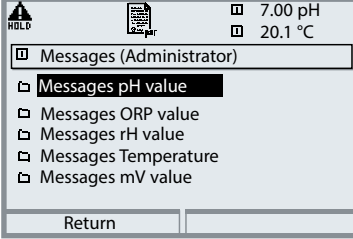
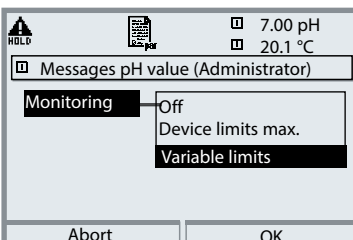
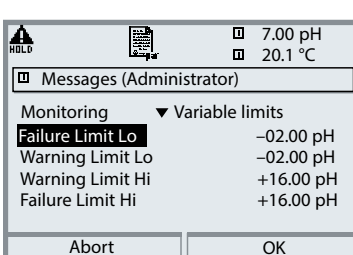
**Note:** Function check (HOLD) mode active

Note: The display may vary depending on the device version.

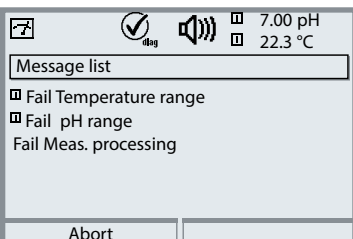
Menu	Display	Messages
	  	<h3>Messages</h3> <p>All parameters determined by the measuring module can generate messages.</p> <ul style="list-style-type: none"> <li>• <b>Device limits max:</b> Messages are generated when the process variable (e.g. pH) is outside the measuring range. The “Failure” icon is displayed, the NAMUR failure contact is activated (BASE module, factory setting: contact K4, N/C contact). The current outputs can signal a 22 mA message (user defined).</li> <li>• <b>Variable limits:</b> For the “failure” and “warning” messages you can define upper and lower limits for message generation.</li> <li>• <b>Message icons:</b> <ul style="list-style-type: none"> <li> Failure (Failure limit HiHi/LoLo)</li> <li> Maintenance (Warning limit Hi/Lo)</li> </ul> </li> </ul>
		<h3>Diagnostics menu</h3> <p>When the “Maintenance” or “Failure” icons are flashing in the display, you should call up the Diagnostics menu. The messages are displayed in the “Message list”.</p>

# Current Outputs

Select menu: Parameter setting/Module BASE

**Note:** Function check (HOLD) mode active

**Note:** The display may vary depending on the device version.

Menu	Display	Parameter setting BASE module
		<p><b>Configuring a Current Output</b></p> <ul style="list-style-type: none"> <li>• Open parameter setting</li> <li>• Enter passcode</li> <li>• Select "Module BASE"</li> <li>• Select "Output current ..."</li> </ul>
		<ul style="list-style-type: none"> <li>• Select process variable</li> </ul>
		<ul style="list-style-type: none"> <li>• Select Curve, e.g. "linear": The measured variable is represented by a linear output current curve. The desired range of the measured variable is specified by the values for "Start" and "End".</li> </ul>

## Assigning measured values: Start (4 mA) and End (20 mA)

Example 1: Range pH 0 - 14

Example 2: Range pH 5 - 7

Advantage: Higher resolution in range of interest

Output current [mA]

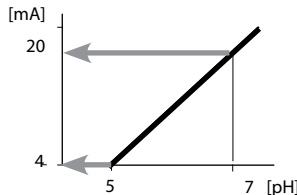
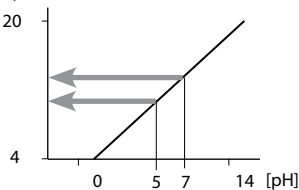

# Current Outputs: Characteristics

---

Select menu: Parameter setting/Module BASE

**Note:** Function check (HOLD) mode active

- **Linear characteristic**

The process variable is represented by a linear output current curve.

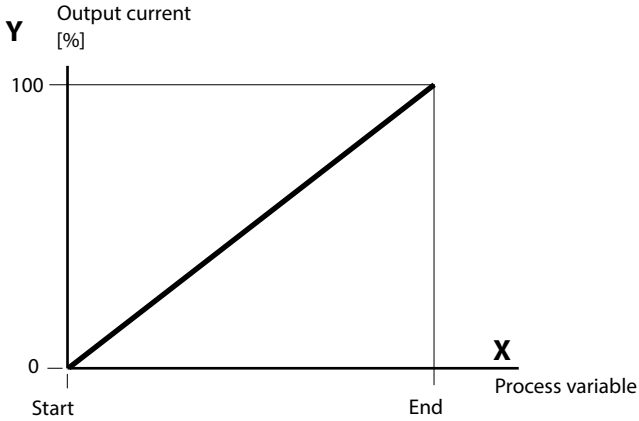

- **Trilinear characteristic**

Two additional vertices must be entered:

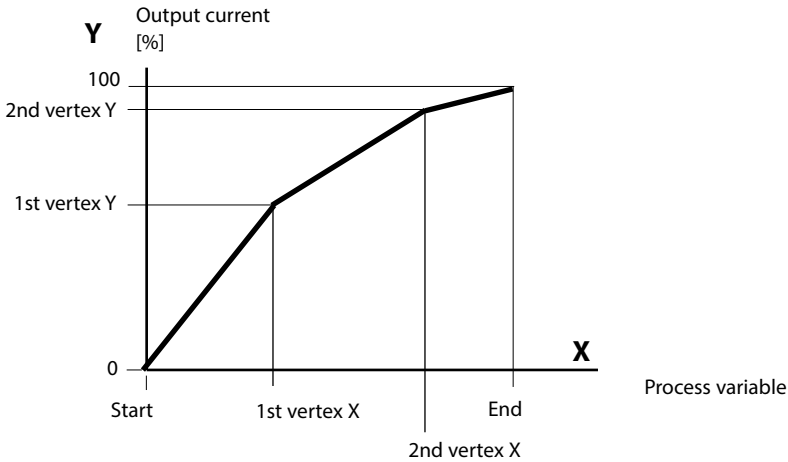

- **Note: Bilinear characteristic**

For a bilinear characteristic, identical parameters are entered for the two vertices (1st vertex, 2nd vertex).

## • Function characteristic

Nonlinear output current characteristic: allows measurements over several decades, e.g. measuring very low values with a high resolution and high values with a low resolution.

Required: Entering a value for 50 % output current.

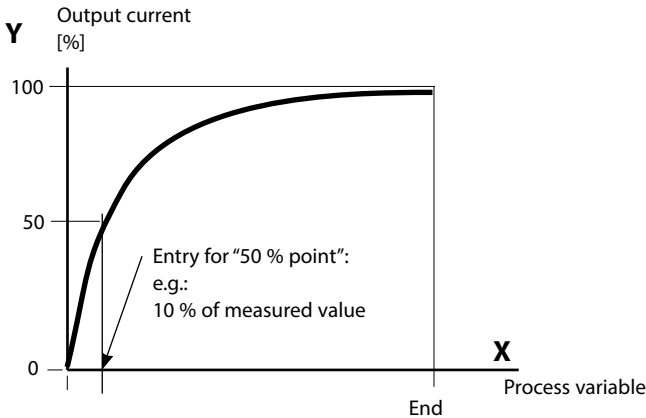

## Equation

$$\text{Output current (4 to 20 mA)} = \frac{(1+K)x}{1+Kx} 16 \text{ mA} + 4 \text{ mA}$$

$$K = \frac{E + S - 2 * X50\%}{X50\% - S} \qquad x = \frac{M - S}{E - S}$$

S: Start value at 4 mA

X50%: 50% value at 12 mA (output current range 4 to 20 mA)

E: End value at 20 mA

M: Measured value

### Logarithmic output curve over one decade:

S: 10 % of maximum value

X50%: 31.6 % of maximum value

E: Maximum value

### Logarithmic output curve over two decades:

S: 1 % of maximum value

X50%: 10 % of maximum value

E: Maximum value

# Current Outputs: Output Filter

---

Select menu: Parameter setting/Module BASE/Output current I.../Output filter

**Note:** Function check (HOLD) mode active

## Time averaging filter

To smoothen the current output, a low-pass filter with adjustable time interval can be switched on. When there is a jump at the input (100 %), the output level is at 63 % after the time interval has been reached.

The time interval can be set from 0 to 120 sec. If the time interval is set to 0 sec, the current output follows the input.

### Note:

The filter only acts on the current output and the current value of the secondary display, not on the measurement display, the limit values or the controller!

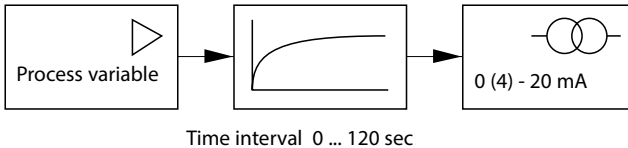

### Note:

For further BASE module settings (behavior during messages, contacts, opto-coupler inputs) refer to the user manual of the basic device.



# Maintenance

Sensor monitor, temp probe adjustment

**Note:** Function check (HOLD) mode active

**Note:** The display may vary depending on the device version.

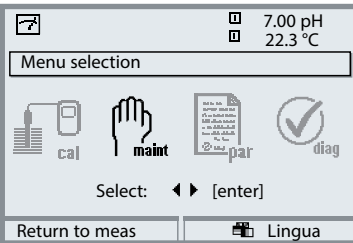
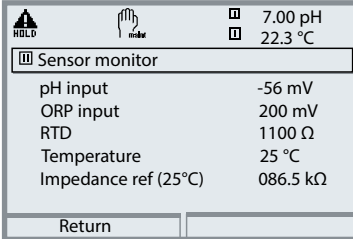
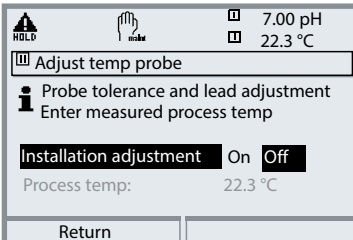

Menu	Display	Maintenance
	  	<p><b>Open Maintenance</b></p> <p>From the measuring mode:            Press <b>menu</b> key to select menu.            Select maintenance using arrow keys,            confirm by pressing <b>enter</b>.            Passcode as delivered: 2958            Then select "Module PH".</p> <p><b>Sensor monitor</b>            for validation of sensor and complete            measured-value processing.</p> <p><b>Temp probe adjustment</b><sup>1)</sup>            This function allows compensating            for the individual temperature probe            tolerance and the influence of the            lead resistances to increase the accu-            racy of temperature measurement.            Make sure that the process tempera-            ture is precisely measured using a            calibrated reference thermometer            when performing an adjustment! The            measurement error of the reference            thermometer should be less than            0.1 °C. Adjustment without precise            measurement might result in consid-            erable deviations of the measured            value display!</p>

1) With Protos II 4400(X) in the Calibration menu

# Diagnostic Functions

General status information of the measuring system  
Menu selection: Diagnostics

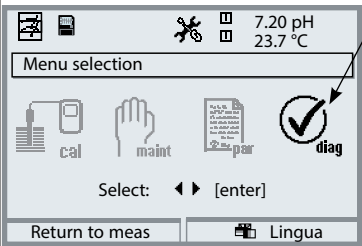
Note: The display may vary depending on the device version.

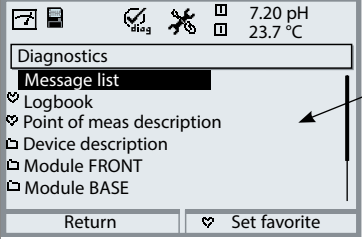
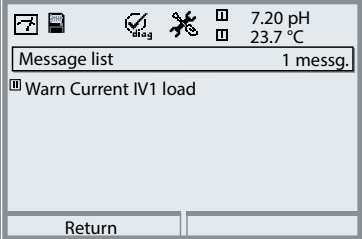
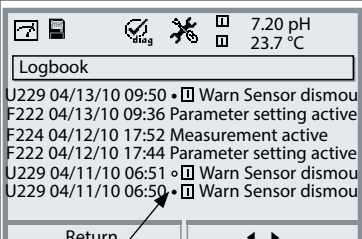
Menu	Display	Diagnostic functions
		<p><b>Opening the diagnostics menu</b></p> <p>From the measuring mode: Press <b>menu</b> key to select menu. Select diagnostics using arrow keys, confirm by pressing <b>enter</b>.</p>
		<p>The "Diagnostics" menu gives an overview of all functions available. Functions which have been set as "Favorite" can be directly accessed from the measuring mode.</p>
		<p><b>Message list</b></p> <p>Shows the currently activated warning or failure messages in plain text.</p>
		<p><b>Logbook</b></p> <p>Shows the last events<sup>1)</sup> with date and time, e.g. calibrations, warning and failure messages, power failure. This permits quality management documentation to ISO 9001. (For parameter setting, see p. 50)</p>
	<p>☐ Releasing module:</p> <ul style="list-style-type: none"> <li>• Message activated</li> <li>◦ Message deactivated</li> </ul>	

# Diagnostic Functions

Device description, FRONT module, BASE module

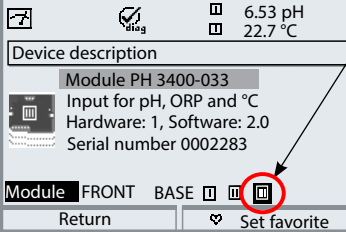
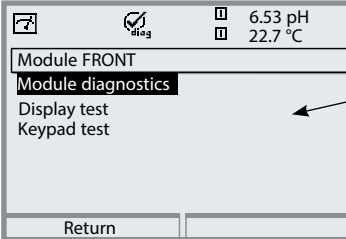
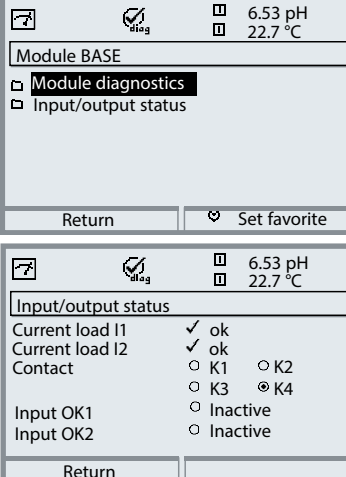

**Note:** The display may vary depending on the device version.

Menu	Display	Diagnostic functions
		<p><b>Device description</b></p> <p>Select module using arrow keys: Provides information about all modules installed: Function, serial number, hardware and firmware version and device options.</p>
		<p><b>FRONT module</b></p> <p>The module contains the display and keypad control.</p> <p>Test possibilities:</p> <ul style="list-style-type: none"> <li>• Module diagnostics</li> <li>• Display test</li> <li>• Keypad test</li> </ul>
		<p><b>BASE module</b></p> <p>The module generates the standard output signals.</p> <p>Test possibilities:</p> <ul style="list-style-type: none"> <li>• Module diagnostics</li> <li>• Input/output status</li> </ul> <p>Example: Module BASE, input/output status.</p>

# Diagnostic Functions

Menu selection: Diagnostics / Module PH ...

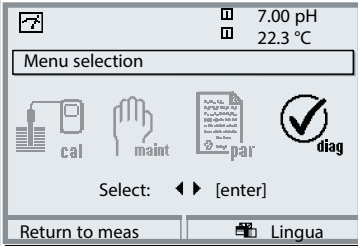

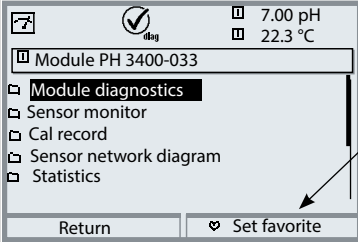
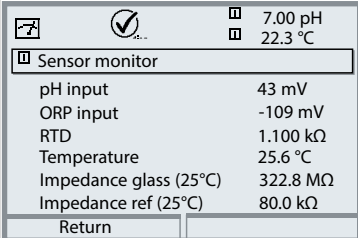
Note: The display may vary depending on the device version.

Menu	Display	Module diagnostics / Sensor monitor
		<p><b>Opening the diagnostics menu</b></p> <p>From the measuring mode: Press <b>menu</b> key to select menu. Select diagnostics using arrow keys, confirm by pressing <b>enter</b>. Then select "Module PH".</p>
		<p>The Diagnostics menu gives an overview of all diagnostics functions available. <u>Messages set as "Favorite"</u> can be called up directly from the measuring mode using a softkey.</p> <p>To configure: Parameter setting / System control / Function control matrix.</p>
		<p><b>Module diagnostics</b> Internal function test (without Fig.).</p> <p><b>Sensor monitor</b> Shows the values currently measured by the sensor. Important function for diagnostics and validation! (cf Maintenance)</p>

# Diagnostic Functions

Cal timer, adaptive cal timer, tolerance adjustment

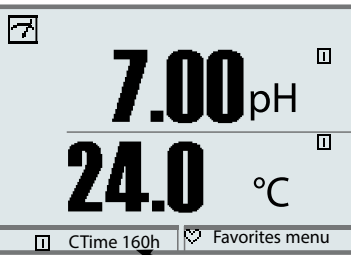

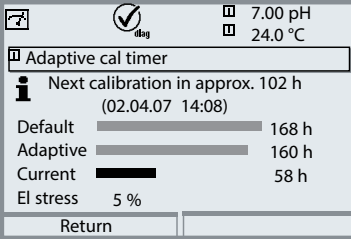
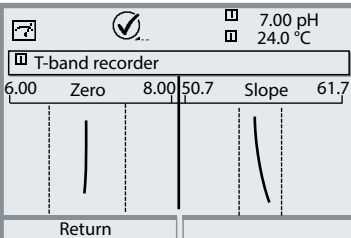









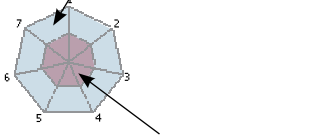

Note: The display may vary depending on the device version.

Menu	Display	Cal timer, tolerance band recorder
		<p><b>Calibration timer</b></p> <p>After expiration of a presettable interval (Parameter setting, Module PH, Cal preset values), the calibration timer generates a warning message as a reminder that calibration is required. The remaining time can be indicated in the measuring mode by pressing a softkey (secondary display: "CTime").</p>
		<p><b>Adaptive calibration timer</b></p> <p>The time until the next due calibration is automatically reduced depending on the temperature and pH value, i.e. old electrode = timer expires sooner.</p>
		<p><b>Tolerance adjustment</b></p> <p>Add-on function SW3400-005 / FW4400-005<sup>1)</sup></p> <p>Records the tolerance ranges for zero and slope over the time. If the values determined by a calibration exceed the tolerance limits, the calibration is taken over as adjustment. Display can be graphical or as a listing. The tolerance band (zero, slope) is configured during parameter setting (Module PH, Cal preset values).</p>

1) Protos II 4400(X): FW4400-005 only available from FRONT firmware version 02.xx.xx.

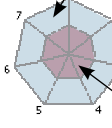
# Diagnostic Functions

Note: The display may vary depending on the device version.

Menu	Display	Cal record, sensor diagram, statistics
	<div style="border: 1px solid black; padding: 5px;"> <div style="display: flex; justify-content: space-between; align-items: center;"> <span></span> <span> <small>diag</small></span> <span> 7.00pH  24.2°C</span> </div> <div style="border: 1px solid black; padding: 2px; margin-top: 5px;"> <p>Cal record</p> <p>Active adjustment 04/03/10 15:35</p> <p>Sensor type InPro3200SG</p> <p>Serial number 00150313</p> <p>Cal mode Calimatic</p> <p>Zero 6.95 pH</p> <p>Slope 058.7 mV/pH</p> </div> <div style="display: flex; justify-content: space-between; margin-top: 5px;"> <span>Return</span> <span>Calibration data</span> </div> </div>	<p><b>Cal record</b></p> <p>Data of last adjustment/calibration, suitable for documentation to ISO 9001 and GLP/GMP (Date, time, calibration method, zero and slope, isothermal potential, information concerning calibration buffers and response times)</p>
	<div style="border: 1px solid black; padding: 5px;"> <div style="display: flex; justify-content: space-between; align-items: center;"> <span></span> <span> <small>diag</small></span> <span> 7.00pH  24.1°C</span> </div> <div style="border: 1px solid black; padding: 2px; margin-top: 5px;"> <p>Sensor diagram</p>  </div> <div style="display: flex; justify-content: space-between; margin-top: 5px;"> <span>Return</span> </div> </div> <div style="margin-top: 20px;"> <p>"Outer circle" Value within tolerance</p>  <p>Critical range – "inner circle" Value out of tolerance The tolerance can be modified as required!</p> </div>	<p><b>Sensor diagram</b></p> <p>Graphical representation of the sensor parameters. Tolerance limit violations can be seen at a glance. Critical parameters are flashing. Parameters displayed in gray have been disabled during parameter setting or do not apply to the currently selected sensor. The tolerance limits (radius of "inner circle") can be modified as desired. See Parameter setting / Sensor data / Sensor monitoring details.</p>
	<div style="border: 1px solid black; padding: 5px;"> <div style="display: flex; justify-content: space-between; align-items: center;"> <span></span> <span> <small>diag</small></span> <span> 7.00pH  20.2°C</span> </div> <div style="border: 1px solid black; padding: 2px; margin-top: 5px;"> <p>Statistics</p> <p>Zero</p> <p>1st Cal +07.00 pH 04/03/10 10:03</p> <p>Diff +00.03 pH 04/03/10 17:24</p> <p>Diff +00.02 pH 04/10/10 09:18</p> <p>Diff +00.03 pH 04/11/10 10:47</p> <p>Slope</p> </div> <div style="display: flex; justify-content: space-between; margin-top: 5px;"> <span>Return</span> </div> </div>	<p><b>Statistics</b></p> <p>Indication of sensor data for the First Calibration (adjustment) and the last 3 calibrations compared to the First Calibration. (Date and time of First Calibration, zero and slope, impedance of glass and reference electrode, response time.)</p>

---

# Setting Diagnostic Messages as Favorite

Select menu: Parameter setting/System control/Function control matrix

## Secondary displays (1)

Here, additional values are displayed in the measuring mode according to the factory setting. When the respective softkey (2) is pressed, the process variables measured by the modules plus date or time are displayed. In addition, you can use the **softkeys (2)** to control functions.

To assign a function to a softkey, select

## Parameter setting/System control/ Function control matrix

Function which can be controlled by softkeys:

- Parameter set selection
- Kl recorder Start/Stop<sup>1)</sup>
- Favorites
- Unical (fully automated probe controller)<sup>2)</sup>

## Favorites

Selected Diagnostic functions can be called directly from the measuring mode using a softkey.

The table on the next page explains how to select favorites.

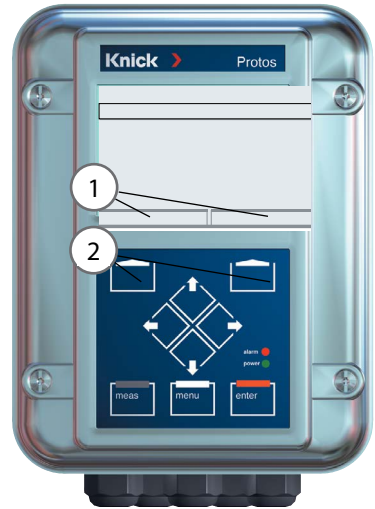

			7.00 pH	
			25.6 °C	
Function control matrix (Administrator)				
	ParSet	Kl rec.	♥ Fav	Unical
Input OK2	<input type="radio"/>	<input type="radio"/>	<input type="radio"/>	<input type="radio"/>
<b>Left softkey</b>	<input type="radio"/>	<input type="radio"/>	<input type="radio"/>	<input type="radio"/>
Right softkey	<input type="radio"/>	<input type="radio"/>	<input checked="" type="radio"/>	<input type="radio"/>
Profibus DO 2	<input type="radio"/>	<input type="radio"/>	<input type="radio"/>	<input type="radio"/>
Return		Connect		

Example:  
"Favorites" to be selected with  
"Right softkey"

To select a softkey function:  
Select desired function using arrow  
keys,  
press "Connect" softkey and  
confirm with **enter**.



To deselect a function:  
Press "Disconnect" softkey,  
confirm with **enter**.

1) With Protos 3400(X)

2) With Protos II 4400(X) from FRONT firmware version 02.xx.xx.

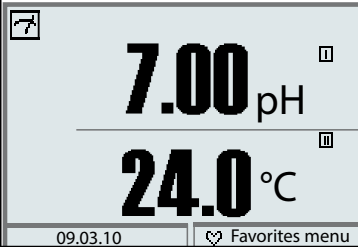

Note: The display may vary depending on the device version.

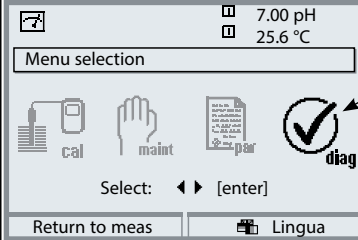
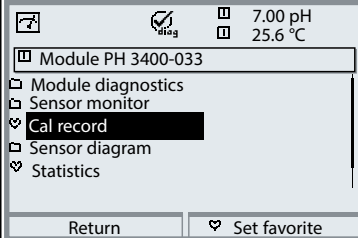
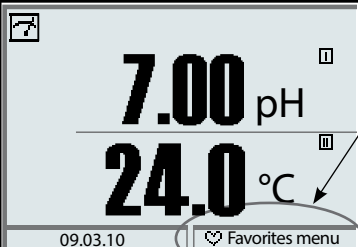
Menu	Display	Select favorites
		<b>Favorites menu</b> Diagnostic functions can be called directly from the measuring mode using a softkey. The "Favorites" are selected in the Diagnostics menu.
		<b>Select favorites</b> Press <b>menu</b> key to select menu. Select diagnostics using arrow keys, confirm with <b>enter</b> . Then select module and confirm with <b>enter</b> .
		Set/delete favorite: "Set favorite" allows activation of the selected diagnostic function directly from the measuring mode via softkey. The menu line is marked with a heart icon.
		Pressing the <b>meas</b> key returns to measurement. When the softkey has been assigned to "Favorites", "Favorites menu" is read in the secondary display (see "Function control matrix").

**Note:**



When one of the softkeys has been assigned to the "Favorites menu" function, diagnostic functions which have been set as "Favorite" can be directly called from the measuring mode.

# Diagnostic Functions

General status information of the measuring system

Select menu: Diagnostics - Message list

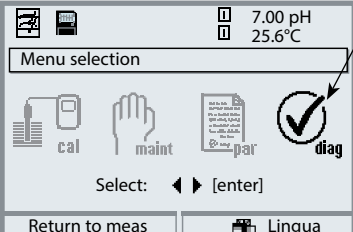
Note: The display may vary depending on the device version.

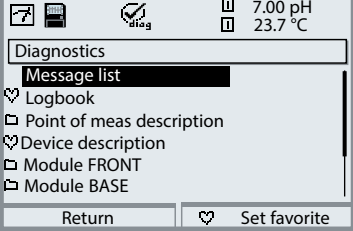
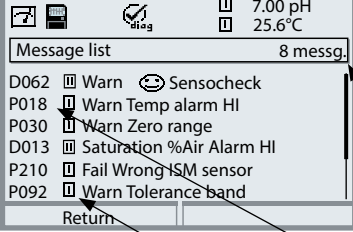
Menu	Display	Diagnostic functions
		<p><b>Opening the diagnostics menu</b></p> <p>From the measuring mode: Press <b>menu</b> key to select menu. Select diagnostics using arrow keys, confirm by pressing <b>enter</b>.</p>
		<p>The “Diagnostics” menu gives an overview of all functions available. Functions which have been set as “Favorite” can be directly accessed from the measuring mode.</p>
		<p><b>Message list</b></p> <p>Shows the currently activated warning or failure messages in plain text.</p> <p><b>Number of messages</b></p> <p>When there are more than 7 messages, a vertical scrollbar appears. Scroll with the up/down arrow keys.</p> <p><b>Message identifier</b></p> <p>See message list for description.</p> <p><b>Module identifier</b></p> <p>Specifies the module that has generated the message.</p>

# Messages

---

## Messages for PH 3400(X)-033 Module with Protos 3400(X)

No.	PH message	Message type
P008	Meas. processing (factory settings)	FAIL
P009	Module failure (Firmware Flash check sum)	FAIL
P010	pH range	FAIL
P011	pH Alarm LO_LO	FAIL
P012	pH Alarm LO	WARN
P013	pH Alarm HI	WARN
P014	pH Alarm HI_HI	FAIL
P015	Temperature range	FAIL
P016	Temperature Alarm LO_LO	FAIL
P017	Temperature Alarm LO	WARN
P018	Temperature Alarm HI	WARN
P019	Temperature Alarm HI_HI	FAIL
P020	ORP range	FAIL
P021	ORP Alarm LO_LO	FAIL
P022	ORP Alarm LO	WARN
P023	ORP Alarm HI	WARN
P024	ORP Alarm HI_HI	FAIL
P025	rH range	WARN
P026	rH Alarm LO_LO	FAIL
P027	rH Alarm LO	WARN
P028	rH Alarm HI	WARN
P029	rH Alarm HI_HI	FAIL
P030	Zero range	WARN
P035	Slope range	WARN
P040	Isotherm potential Uis range	WARN
P045	mV range	WARN

# Messages

---

No.	PH message	Message type
P046	mV Alarm LO_LO	FAIL
P047	mV Alarm LO	WARN
P048	mV Alarm HI	WARN
P049	mV Alarm HI_HI	FAIL
P050	Man. temperature range	FAIL
P060	SAD SENSOFACE: Slope	User-defined
P061	SAD SENSOFACE: Zero	User-defined
P062	SAD SENSOFACE: Ref impedance (Sensochek)	User-defined
P063	SAD SENSOFACE: Glass impedance (Sensochek)	User-defined
P064	SAD SENSOFACE: Response time	User-defined
P065	SAD SENSOFACE: Calibration timer	WARN
P066	SAD SENSOFACE: Calcheck	User-defined
P069	SAD SENSOFACE: Calimatic (Zero/slope)	WARN
P070	SAD SENSOFACE: Sensor wear	User-defined
P071	SAD SENSOFACE: ISFET leakage current	User-defined
P090	Buffer offset (buffer table to be entered):	WARN
P091	Zero offset ORP	WARN
P092	Tolerance band	WARN
P110	CIP counter	User-defined
P111	SIP counter	User-defined
P112	Autoclaving counter	User-defined
P113	Sensor operating time (duration of use)	User-defined
P114	ISFET characteristic	User-defined
P115	Membrane body changes	User-defined
P120	Wrong ISM sensor	FAIL
P121	ISM sensor (error in factory settings/characteristics)	FAIL
P122	ISM sensor memory (error in cal data records)	WARN
P123	New sensor, adjustment required	WARN
P130	SIP cycle counted	Text
P131	CIP cycle counted	Text

# Messages

---

No.	PH message	Message type
P200	Noise level at pH input	FAIL
P201	Cal temp	WARN
P202	Cal: Buffer unknown	Text
P203	Cal: Identical buffers	Text
P204	Cal: Buf interchanged	Text
P205	Cal: Sensor unstable	Text
P206	Cal: Slope	WARN
P207	Cal: Zero	WARN
P208	Cal: Sensor failure (ORP check)	FAIL
P254	Module reset	Text

No.	Calculation Block PH / PH messages	Message type
A010	pH-Diff Range	FAIL
A011	pH-Diff Alarm LO_LO	FAIL
A012	pH-Diff Alarm LO	WARN
A013	pH-Diff Alarm HI	WARN
A014	pH-Diff Alarm HI_HI	FAIL
A015	Temperature-Diff Range	FAIL
A016	Temperature-Diff Alarm LO_LO	FAIL
A017	Temperature-Diff Alarm LO	WARN
A018	Temperature-Diff Alarm HI	WARN
A019	Temperature-Diff Alarm HI_HI	FAIL
A020	ORP-Diff Range	FAIL
A021	ORP-Diff Alarm LO_LO	FAIL
A022	ORP-Diff Alarm LO	WARN
A023	ORP-Diff Alarm HI	WARN
A024	ORP-Diff Alarm HI_HI	FAIL

# Messages

---

## Messages for PH 3400(X)-033 Module with Protos II 4400(X)

 Failure  Out of Specification  Maintenance Required

No.	Message Type	PH Message
P008	Failure	Meas. Processing (Factory Settings)
P009	Failure	Firmware Error
P010	Failure	pH Range
P011	Failure	pH Alarm LO_LO
P012	Out of Specification	pH Alarm LO
P013	Out of Specification	pH Alarm HI
P014	Failure	pH Alarm HI_HI
P015	Failure	Temperature Range
P016	Failure	Temperature Alarm LO_LO
P017	Out of Specification	Temperature Alarm LO
P018	Out of Specification	Temperature Alarm HI
P019	Failure	Temperature Alarm HI_HI
P020	Failure	ORP Range
P021	Failure	ORP Alarm LO_LO
P022	Out of Specification	ORP Alarm LO
P023	Out of Specification	ORP Alarm HI
P024	Failure	ORP Alarm HI_HI
P025	Out of Specification	rH range
P026	Failure	rH Alarm LO_LO
P027	Out of Specification	rH Alarm LO
P028	Out of Specification	rH Alarm HI
P029	Failure	rH Alarm HI_HI
P045	Failure	mV Range
P046	Failure	mV Alarm LO_LO
P047	Out of Specification	mV Alarm LO
P048	Out of Specification	mV Alarm HI
P049	Failure	mV Alarm HI_HI
P060	Failure/Maintenance Required	Sad Sensoface: Slope
P061	Failure/Maintenance Required	Sad Sensoface: Zero Point
P062	User-defined	Sad Sensoface: Reference Impedance
P063	User-defined	Sad Sensoface: Glass Impedance
P064	User-defined	Sad Sensoface: Response Time

# Messages

---

<b>No.</b>	<b>Message Type</b>	<b>PH Message</b>
P065	Maintenance Required	Sad Sensoface: Calibration timer
P069	Maintenance Required	Sad Sensoface: Calimatic (Zero/Slope)
P070	User-defined	Sad Sensoface: Sensor Wear
P071	Maintenance Required	Sad Sensoface: ISFET Leakage Current
P072	Maintenance Required	Sad Sensoface: ISFET Operating Point
P074	Maintenance Required	Sad Sensoface: ORP Zero Offset
P090	Maintenance Required	Buffer Distance (User-Defined Buffer Table)
P092	Maintenance Required	Tolerance Band
P112	User-defined	Autoclaving Counter
P200	Failure	Noise Level at pH Input
P201	Maintenance Required	Cal Temperature
P202	Info	Cal: Buffer Unknown
P203	Info	Cal: Identical Buffers
P204	Info	Cal: Buffers Interchanged
P205	Info	Cal: Sensor Unstable
P206	Maintenance Required	Cal: Slope
P207	Maintenance Required	Cal: Zero Point
P208	Failure	Cal: Sensor Failure (ORP Check)
P254	Info	Module Reset

# Messages

---

<b>No.</b>	<b>Message Type</b>	<b>Calculation Block PH / PH Messages</b>
A010	Failure	pH Diff Range
A011	Failure	pH Diff Alarm LO_LO
A012	Out of Specification	pH Diff Alarm LO
A013	Out of Specification	pH Diff Alarm HI
A014	Failure	pH Diff Alarm HI_HI
A015	Failure	Temperature Diff Range
A016	Failure	Temperature Diff Alarm LO_LO
A017	Out of Specification	Temperature Diff Alarm LO
A018	Out of Specification	Temperature Diff Alarm HI
A019	Failure	Temperature Diff Alarm HI_HI
A020	Failure	ORP Diff Range
A021	Failure	ORP Diff Alarm LO_LO
A022	Out of Specification	ORP Diff Alarm LO
A023	Out of Specification	ORP Diff Alarm HI
A024	Failure	ORP Diff Alarm HI_HI
A045	Failure	mV Diff Range
A046	Failure	mV Diff Alarm LO_LO
A047	Out of Specification	mV Diff Alarm LO
A048	Out of Specification	mV Diff Alarm HI
A049	Failure	mV Diff Alarm HI_HI
A200	Maintenance Required	Calculation Block Configuration



# Specifications

---

## Specifications Protos PH 3400(X)-033

<b>pH/ORP input</b> PH3400X-033: Ex ia IIC	pH measurement with Pfaudler differential probe Input for measuring electrode Input for reference electrode Input for aux. electrode
Measuring range (MR)	pH value -2.00 ... +16.00 ORP value -2000 ... +2000 mV rH value 0.0 ... 42.5
Adm. cable capacitance	< 2 nF
Meas. electrode input**	Input resistance > 1 x 10 <sup>12</sup> Ω Input current < 1 x 10 <sup>-12</sup> A **** Impedance range 0.5 ... 1000 MΩ
Reference electrode input**	Input resistance > 1 x 10 <sup>11</sup> Ω Input current < 1 x 10 <sup>-11</sup> A **** Impedance range 0.5 ... 1000 kΩ
Measurement error*** (Display)	pH value < 0.02 TC < 0.001 pH/K ORP value < 1 mV TC < 0.05 mV/K
<b>Temperature input</b> PH3400X-033: Ex ia IIC Measurement range	Pt 100/Pt 1000/NTC 30 kΩ/NTC 8.55 kΩ 3-wire connection, adjustable -20 ... 150 °C / -4 ... 302 °F (Pt 100/Pt 1000/NTC 30 kΩ) -10 ... 130 °C / 14 ... 266 °F (NTC 8.55 kΩ, Mitsubishi)
Resolution	0.1 °C
Measurement error***	0.2 % meas.val. + 0.5 K (< 1 K with NTC > 100 °C)
<b>Temp compensation media-related</b>	Reference temp 25 °C / 77 °F <ul style="list-style-type: none"><li>• Linear temperature coefficient, user-defined from -19.99 to 19.99 % / K</li><li>• Ultrapure water 0 ... 150 °C / 32 ... 302 °F</li><li>• Table 0 ... 95 °C / 32 ... 203 °F, user-defined in 5 K steps</li></ul>

# Specifications

---

## Power output

PH3400X-033: Ex ia IIC

for operating an ISFET adapter

+3 V ( $V_o = +2.9 \dots +3.1 \text{ V} / R_i = 360 \Omega$ )

-3 V ( $V_o = -3.5 \dots -3.0 \text{ V} / R_i = 360 \Omega$ )

## pH sensor standardization \*

1-/2-/3-point calibration (best fit line)

Operating modes:

- Calimatic automatic buffer recognition
- Input of individual buffer values
- Product calibration
- Data entry of pre-measured electrodes
- Determination of nominal zero

Drift check\*

Fine / standard / coarse

Calimatic buffer sets\*

- Fixed buffer sets:

Mettler-Toledo 2.00 / 4.01 / 7.00 / 9.21

Knick CaliMat 2.00 / 4.00 / 7.00 / 9.00 / 12.00

DIN 19267 1.09 / 4.65 / 6.79 / 9.23 / 12.75

NIST standard 4.006 / 6.865 / 9.180

Techn. buffers to NIST 1.68 / 4.00 / 7.00 / 10.01 / 12.46

Hamilton 2.00 / 4.01 / 7.00 / 10.01 / 12.00

Kraft 2.00 / 4.00 / 7.00 / 9.00 / 11.00

Hamilton buffer A 2.00 / 4.01 / 7.00 / 9.00 / 11.00

Hamilton buffer B 2.00 / 4.01 / 6.00 / 9.00 / 11.00

HACH 4.01 / 7.00 / 10.00

Ciba 2.06 / 4.00 / 7.00 / 10.0

Reagecon 2.00 / 4.00 / 7.00 / 9.00 / 12.00

- Manually enterable buffer set with max. three buffer tables

(add-on function SW3400-002 / FW4400-002)

Nom. zero\*

pH 0 ... 14; calibration range  $\Delta\text{pH} = \pm 1$

Nom. slope (25 °C) \*

25 ... 61 mV/pH; calibration range 80 ... 103 %

pHis \*

0 ... 14

# Specifications

---

<b>Calibration record</b>	Recording of: Zero point, slope, Viso, response time, calibration method with date and time
<b>Statistics</b>	Recording of: Zero, slope, Viso, response time, glass and reference impedance with date and time of the last three calibrations and the First Calibration
<b>Sensocheck</b>	Automatic monitoring of glass and reference electrode, message can be switched off
<b>Sensoface</b>	Provides information on the sensor condition: Zero/slope, response time, calibration interval, Sensocheck (can be disabled)
<b>Sensor diagram</b>	Graphical representation of current sensor parameters in a radar chart on the display: Slope, zero, reference impedance, glass impedance, response time, cal timer
<b>Sensor monitor</b>	Direct display of measured values from sensor for validation pH input / glass el. impedance / ref. el. impedance / RTD / temperature
<b>KI recorder</b> (SW3400-001, Protos 3400(X))	Adaptive representation of a process sequence with monitoring and signaling of critical parameters
<b>Adaptive cal timer*</b>	Automatic adjustment of calibration interval (Sensoface signal), depending on measured values
<b>Tolerance adjustment</b> (SW3400-005/FW4400-005)	Tolerant calibration/adjustment, tolerance limits adjustable, graphical recording of zero point and slope of the last 40 calibrations/adjustments

\* user-defined \*\* at rated operating conditions \*\*\*  $\pm 1$  count, plus sensor error

\*\*\*\* at 20 °C/68 °F, doubles every 10 K

# Specifications

---

## General data

<b>Explosion protection</b> (Ex version of module only)	See certificates or <a href="http://www.knick.de">www.knick.de</a>
<b>RoHS conformity</b>	According to EU directive 2011/65/EU
<b>EMC</b>  Emitted interference Interference immunity Lightning protection	EN 61326-1, EN 61326-2-3 NAMUR NE 21 Industrial applications* (EN 55011 Group 1 Class A) Industrial applications to EN 61000-4-5, Installation class 2
<b>Rated operating conditions</b>	Ambient temperature: Safe area: -20 ... 55 °C / -4 ... 131 °F Ex: -20 ... 50 °C / -4 ... 122 °F Relative humidity: 10 ... 95 % non-condensing
<b>Transport/storage temperature</b>	-20 ... 70 °C / -4 ... 158 °F
<b>Screw clamp connector</b>	Single or stranded wires up to 2.5 mm <sup>2</sup>

\* This equipment is not designed for domestic use, and is unable to guarantee adequate protection of the radio reception in such environments.

# Appendix:

---

## Minimum spans for current outputs

The PH 3400(X)-033 module is a measuring module.

It does not provide current outputs.

Current outputs are provided by the BASE module (basic device)

or by communication modules (e.g. OUT, PID).

The corresponding parameters must be set there.

The minimum current span shall prevent that the resolution limit of the measurement technology ( $\pm 1$  count) is seen in the current.

### **PH 3400(X)-033 Module**

pH	1.00
ORP	100.0
°C	10.0
mV	100.0
rH	1.00
°F	10.0

### **Calculation Block PH/PH**

Diff pH	1.00
Diff ORP	100.0
Diff °C	10.0

# Appendix:

---

Buffer table "Mettler-Toledo"

° C	pH			
0	2,03	4,01	7,12	9,52
5	2,02	4,01	7,09	9,45
10	2,01	4,00	7,06	9,38
15	2,00	4,00	7,04	9,32
20	2,00	4,00	7,02	9,26
<b>25</b>	<b>2,00</b>	<b>4,01</b>	<b>7,00</b>	<b>9,21</b>
30	1,99	4,01	6,99	9,16
35	1,99	4,02	6,98	9,11
40	1,98	4,03	6,97	9,06
45	1,98	4,04	6,97	9,03
50	1,98	4,06	6,97	8,99
55	1,98	4,08	6,98	8,96
60	1,98	4,10	6,98	8,93
65	1,99	4,13	6,99	8,90
70	1,99	4,16	7,00	8,88
75	2,00	4,19	7,02	8,85
80	2,00	4,22	7,04	8,83
85	2,00	4,26	7,06	8,81
90	2,00	4,30	7,09	8,79
95	2,00	4,35	7,12	8,77

---

# Appendix:

---

Buffer table "Knick CaliMat"

°C	pH				
Order No.	CS-P0200A/...	CS-P0400A/...	CS-P0700A/...	CS-P0900A/...	CS-P1200A/...
0	2.01	4.05	7.09	9.24	12.58
5	2.01	4.04	7.07	9.16	12.39
10	2.01	4.02	7.04	9.11	12.26
15	2.00	4.01	7.02	9.05	12.13
<b>20</b>	<b>2.00</b>	<b>4.00</b>	<b>7.00</b>	<b>9.00</b>	<b>12.00</b>
25	2.00	4.01	6.99	8.95	11.87
30	2.00	4.01	6.98	8.91	11.75
35	2.00	4.01	6.96	8.88	11.64
40	2.00	4.01	6.96	8.85	11.53
50	2.00	4.01	6.96	8.79	11.31
60	2.00	4.00	6.96	8,73	11.09
70	2.00	4.00	6.96	8,70	10.88
80	2.00	4.00	6.98	8,66	10.68
90	2.00	4.00	7.00	8,64	10.48

---

# Appendix:

---

Buffer table "DIN 19267"

°C	pH				
0	1,08	4,67	6,89	9,48	13,95*
5	1,08	4,67	6,87	9,43	13,63*
10	1,09	4,66	6,84	9,37	13,37
15	1,09	4,66	6,82	9,32	13,16
20	1,09	4,65	6,80	3,27	12,96
<b>25</b>	<b>1,09</b>	<b>4,65</b>	<b>6,79</b>	<b>9,23</b>	<b>12,75</b>
30	1,10	4,65	6,78	9,18	12,61
35	1,10	4,65	6,77	9,13	12,45
40	1,10	4,66	6,76	9,09	12,29
45	1,10	4,67	6,76	9,04	12,09
50	1,11	4,68	6,76	9,00	11,98
55	1,11	4,69	6,76	8,96	11,79
60	1,11	4,70	6,76	8,92	11,69
65	1,11	4,71	6,76	8,90	11,56
70	1,11	4,72	6,76	8,88	11,43
75	1,11	4,73	6,77	8,86	11,31
80	1,12	4,75	6,78	8,85	11,19
85	1,12	4,77	6,79	8,83	11,09
90	1,13	4,79	6,80	8,82	10,99
95	1,13*	4,82*	6,81*	8,81*	10,89*

\* extrapoliert / extrapolated / extrapolée



# Appendix:

---

Buffer table "NIST standard" (DIN 19266: 2000-01)

°C	pH			
0				
5	1.668	4.004	6.950	9.392
10	1.670	4.001	6.922	9.331
15	1.672	4.001	6.900	9.277
20	1.676	4.003	6.880	9.228
<b>25</b>	<b>1.680</b>	<b>4.008</b>	<b>6.865</b>	<b>9.184</b>
30	1,685	4.015	6.853	9.144
37	1,694	4.028	6.841	9.095
40	1.697	4.036	6.837	9.076
45	1.704	4.049	6.834	9.046
50	1.712	4.064	6.833	9.018
55	1.715	4.075	6.834	9.985
60	1.723	4.091	6.836	8.962
70	1.743	4.126	6.845	8.921
80	1.766	4.164	6.859	8.885
90	1.792	4.205	6.877	8.850
95	1.806	4.227	6.886	8.833

---

## Notice:

The pH(S) values of the individual charges of the secondary reference materials are documented in a certificate of an accredited laboratory. This certificate is supplied with the respective buffer materials. Only these pH(S) values shall be used as standard values for the secondary reference buffer materials. Correspondingly, this standard does not include a table with standard pH values for practical use. The table above only provides examples of pH(PS) values for orientation.

# Appendix:

---

## Buffer table "Techn. buffers to NIST"

°C	pH		
0	4.00	7.14	10.30
5	4.00	7.10	10.23
10	4.00	7.04	10.11
15	4.00	7.04	10.11
20	4.00	7.02	10.05
25	4.01	7.00	10.00
30	4.01	6.99	9.96
35	4.02	6.98	9.92
40	4.03	6.98	9.88
45	4.05	6.98	9.85
50	4.06	6.98	9.82
55	4.07	6.98	9.79
60	4.09	6.99	9.76
65	4.09 *	6.99 *	9.76 *
70	4.09 *	6.99 *	9.76 *
75	4.09 *	6.99 *	9.76 *
80	4.09 *	6.99 *	9.76 *
85	4.09 *	6.99 *	9.76 *
90	4.09 *	6.99 *	9.76 *
95	4.09 *	6.99 *	9.76 *

---

\* Values complemented

# Appendix:

---

Buffer table "Hamilton"

°C	pH				
0	1,99	4,01	7,12	10,19	12,46
5	1,99	4,01	7,09	10,19	12,46
10	2,00	4,00	7,06	10,15	12,34
15	2,00	4,00	7,04	10,11	12,23
20	2,00	4,00	7,02	10,06	12,11
<b>25</b>	<b>2,00</b>	<b>4,01</b>	<b>7,00</b>	<b>10,01</b>	<b>12,00</b>
30	1,99	4,01	6,99	9,97	11,90
35	1,98	4,02	6,98	9,92	11,80
40	1,98	4,03	6,97	9,86	11,70
45	1,97	4,04	6,97	9,83	11,60
50	1,97	4,06	6,97	9,79	11,51
55	1,97	4,08	6,98	9,77	11,51
60	1,97	4,10	6,98	9,75	11,51
65	1,97	4,13	6,99	9,74	11,51
70	1,97	4,16	7,00	9,73	11,51
75	1,97	4,19	7,02	9,73	11,51
80	1,97	4,22	7,04	9,73	11,51
85	1,97	4,26	7,06	9,74	11,51
90	1,97	4,30	7,09	9,75	11,51
95	1,97	4,35	7,09	9,75	11,51

---

# Appendix:

---

## Buffer table "Kraft"

°C	pH				
0	2.01	4.05	7.13	9.24	11.47*
5	2.01	4.04	7.07	9.16	11.47
10	2.01	4.02	7.05	9.11	11.31
15	2.00	4.01	7.02	9.05	11.15
<b>20</b>	<b>2.00</b>	<b>4.00</b>	<b>7.00</b>	<b>9.00</b>	<b>11.00</b>
25	2.00	4.01	6.98	8.95	10.85
30	2.00	4.01	6.98	8.91	10.71
35	2.00	4.01	6.96	8.88	10.57
40	2.00	4.01	6.95	8.85	10.44
45	2.00	4.01	6.95	8.82	10.31
50	2.00	4.00	6.95	8.79	10.18
55	2.00	4.00	6.95	8.76	10.18*
60	2.00	4.00	6.96	8.73	10.18*
65	2.00	4.00	6.96	8.72	10.18*
70	2.01	4.00	6.96	8.70	10.18*
75	2.01	4.00	6.96	8.68	10.18*
80	2.01	4.00	6.97	8.66	10.18*
85	2.01	4.00	6.98	8.65	10.18*
90	2.01	4.00	7.00	8.64	10.18*
95	2.01	4.00	7.02	8.64	10.18*

\* Values complemented

# Appendix:

---

Buffer table "Hamilton A"

°C	pH				
0	1.99	4.01	7.12	9.31	11.42
5	1.99	4.01	7.09	9.24	11.33
10	2.00	4.00	7.06	9.17	11.25
15	2.00	4.00	7.04	9.11	11.16
20	2.00	4.00	7.02	9.05	11.07
<b>25</b>	<b>2.00</b>	<b>4.01</b>	<b>7.00</b>	<b>9.00</b>	<b>11.00</b>
30	1.99	4.01	6.99	8.95	10.93
35	1.98	4.02	6.98	8.90	10.86
40	1.98	4.03	6.97	8.85	10.80
45	1.97	4.04	6.97	8.82	10.73
50	1.97	4.05	6.97	8.78	10.67
55	1.98	4.06	6.98	8.75	10.61
60	1.98	4.08	6.98	8.72	10.55
65	1.98	4.10	6.99	8.70	10.49
70	1.99	4.12	7.00	8.67	10.43
75	1.99	4.14	7.02	8.64	10.38
80	2.00	4.16	7.04	8.62	10.33
85	2.00	4.18	7.06	8.60	10.28
90	2.00	4.21	7.09	8.58	10.23
95	2.00	4.24	7.12	8.56	10.18

# Appendix:

---

## Buffer table "Hamilton B"

°C	pH				
0	1.99	4.01	6.03	9.31	11.42
5	1.99	4.01	6.02	9.24	11.33
10	2.00	4.00	6.01	9.17	11.25
15	2.00	4.00	6.00	9.11	11.16
20	2.00	4.00	6.00	9.05	11.07
<b>25</b>	<b>2.00</b>	<b>4.01</b>	<b>6.00</b>	<b>9.00</b>	<b>11.00</b>
30	1.99	4.01	6.00	8.95	10.93
35	1.98	4.02	6.00	8.90	10.86
40	1.98	4.03	6.01	8.85	10.80
45	1.97	4.04	6.02	8.82	10.73
50	1.97	4.05	6.04	8.78	10.67
55	1.98	4.06	6.06	8.75	10.61
60	1.98	4.08	6.09	8.72	10.55
65	1.98	4.10	6.11	8.70	10.49
70	1.99	4.12	6.13	8.67	10.43
75	1.99	4.14	6.15	8.64	10.38
80	2.00	4.16	6.18	8.62	10.33
85	2.00	4.18	6.21	8.60	10.28
90	2.00	4.21	6.24	8.58	10.23
95	2.00	4.24	6.27	8.56	10.18

# Appendix:

---

Buffer table "HACH"

T [°C]	pH		
0	4,00	7,118	10,30
5	4,00	7,087	10,23
10	4,00	7,059	10,17
15	4,00	7,036	10,11
20	4,00	7,016	10,05
<b>25</b>	<b>4,01</b>	<b>7,000</b>	<b>10,00</b>
30	4,01	6,987	9,96
35	4,02	6,977	9,92
40	4,03	6,970	9,88
45	4,05	6,965	9,85
50	4,06	6,964	9,82
55	4,07	6,965	9,79
60	4,09	6,968	9,76
65	4,10	6,980	9,71
70	4,12	7,000	9,66
75	4,14	7,020	9,63
80	4,16	7,040	9,59
85	4,18	7,060	9,56
90	4,21	7,090	9,52
95	4,24	7,120	9,48

# Appendix:

---

## Buffer table "Ciba"

°C	pH			
0	2,04	4,00	7,10	10,30
5	2,09	4,02	7,08	10,21
10	2,07	4,00	7,05	10,14
15	2,08	4,00	7,02	10,06
20	2,09	4,01	6,98	9,99
25	2,08	4,02	6,98	9,95
30	2,06	4,00	6,96	9,89
35	2,06	4,01	6,95	9,85
40	2,07	4,02	6,94	9,81
45	2,06	4,03	6,93	9,77
50	2,06	4,04	6,93	9,73
55	2,05	4,05	6,91	9,68
60	2,08	4,10	6,93	9,66
65	2,07*	4,10*	6,92*	9,61*
70	2,07	4,11	6,92	9,57
75	2,04*	4,13*	6,92*	9,54*
80	2,02	4,15	6,93	9,52
85	2,03*	4,17*	6,95*	9,47*
90	2,04	4,20	6,97	9,43
95	2,05*	4,22*	6,99*	9,38*

\* Extrapolated



# Appendix:

---

Buffer table "Reagecon"

°C	pH				
0°C	*2,01	*4,01	*7,07	*9,18	*12,54
5°C	*2,01	*4,01	*7,07	*9,18	*12,54
10°C	2,01	4,00	7,07	9,18	12,54
15°C	2,01	4,00	7,04	9,12	12,36
20°C	2,01	4,00	7,02	9,06	12,17
<b>25°C</b>	<b>2,00</b>	<b>4,00</b>	<b>7,00</b>	<b>9,00</b>	<b>12,00</b>
30°C	1,99	4,01	6,99	8,95	11,81
35°C	2,00	4,02	6,98	8,90	11,63
40°C	2,01	4,03	6,97	8,86	11,47
45°C	2,01	4,04	6,97	8,83	11,39
50°C	2,00	4,05	6,96	8,79	11,30
55°C	2,00	4,07	6,96	8,77	11,13
60°C	2,00	4,08	6,96	8,74	10,95
65°C	*2,00	*4,10	*6,99	*8,70	*10,95
70°C	*2,00	*4,12	*7,00	*8,67	*10,95
75°C	*2,00	*4,14	*7,02	*8,64	*10,95
80°C	*2,00	*4,16	*7,04	*8,62	*10,95
85°C	*2,00	*4,18	*7,06	*8,60	*10,95
90°C	*2,00	*4,21	*7,09	*8,58	*10,95
95°C	*2,00	*4,24	*7,12	*8,56	*10,95

\* Values complemented



# Specifiable Buffer Sets

SW3400-002 / FW4400-002

Select menu: Parameter setting/System control/Buffer table

## Specifying an Individual Buffer Set for pH Measurement

You can enter an individual buffer set with 3 buffer solutions. To do so, enter the nominal buffer values for the correct temperature (0 ... 95 °C / 32 ... 203 °F, 5 °C/9 °F step size). Then this buffer set is available as "Table" in addition to the permanently set standard buffer solutions.

Note: The display may vary depending on the device version.

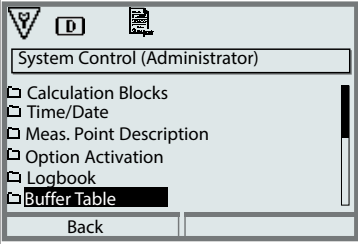
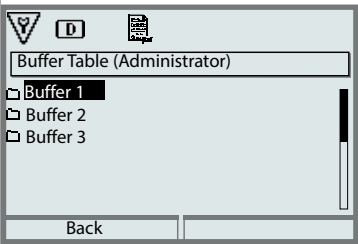
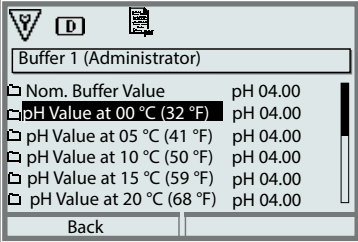
Menu	Display	Action
	 <p>System Control (Administrator)</p> <ul style="list-style-type: none"> <li>▢ Calculation Blocks</li> <li>▢ Time/Date</li> <li>▢ Meas. Point Description</li> <li>▢ Option Activation</li> <li>▢ Logbook</li> <li>▢ <b>Buffer Table</b></li> </ul> <p>Back</p>	<b>Entering a Buffer Set</b> 1) Parameter Setting 2) System Control 3) Buffer Table
	 <p>Buffer Table (Administrator)</p> <ul style="list-style-type: none"> <li>▢ <b>Buffer 1</b></li> <li>▢ Buffer 2</li> <li>▢ Buffer 3</li> </ul> <p>Back</p>	Select buffer to be entered. Enter the values for 3 complete buffer solutions in ascending order (e.g. pH 4, 7, 10). Minimum distance: 2 pH units
	 <p>Buffer 1 (Administrator)</p> <ul style="list-style-type: none"> <li>▢ Nom. Buffer Value pH 04.00</li> <li>▢ <b>pH Value at 00 °C (32 °F)</b> pH 04.00</li> <li>▢ pH Value at 05 °C (41 °F) pH 04.00</li> <li>▢ pH Value at 10 °C (50 °F) pH 04.00</li> <li>▢ pH Value at 15 °C (59 °F) pH 04.00</li> <li>▢ pH Value at 20 °C (68 °F) pH 04.00</li> </ul> <p>Back</p>	Enter nominal buffer value and all other values for the correct temperature (right/left arrow keys to select position, up/down arrow keys to edit number, press <b>enter</b> to confirm.)

### The individual buffer set is selected in the menu:

Parameter Setting/PH Module/Cal Presettings:

Calibration mode: Calimatic, Buffer Set: Table.

# Overview

## Overview of Parameter Setting

### Parameter Setting Menu

Note: The menus may vary depending on the device version

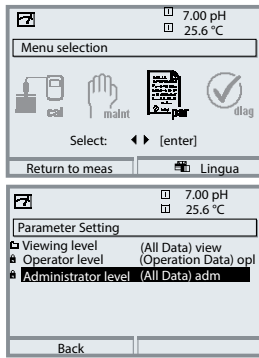

#### Parameter Setting

From measuring mode: Press **menu** key to select menu. Select parameter setting using arrow keys, press **enter** to confirm.

##### Administrator level

Access to all functions, also passcode setting. Releasing or blocking functions for access from the Operator level.

##### Operator level

Access to all functions which have been released at the Administrator level. Blocked functions are displayed in gray and cannot be edited.

##### Viewing level

Only display, no editing possible!

#### System Control

Memory card (Option)	Menu only appears when a memory card is inserted and the corresponding add-on function has been enabled.
Transfer configuration	The complete configuration of a device can be written on a memory card. This allows transferring all device settings to other devices with identical equipment (exception: options and passcodes).
Parameter set	2 parameter sets (A, B) are available in the device. The currently active parameter set is shown in the display. Parameter sets contain all settings except: sensor type, options, system control settings Up to 5 parameter sets (1, 2, 3, 4, 5) are available when a memory card (Option) is used.
Function control	Select the functions to be controlled via softkeys and OK inputs
Time/date	Time, date, display format
Meas. point description	Free input of a tag number, can be called from the diagnostics menu
Release of options	Option activation via TAN
Reset to default	Reset all parameters to factory setting
Passcode entry	Change passcodes
Firmware update	Update the firmware using an Update Card
Logbook	Select the events to be recorded

# Overview

## Overview of Parameter Setting

### Parameter Setting Menu



#### FRONT Module: Display Settings

Language	Select the menu language
Units <sup>1)</sup>	Select the measurement units
Formats <sup>1)</sup>	Select the display format
Measurement display	Representation of measured values on the display
Display	Brightness/contrast, auto-off

#### BASE Module: Signal Outputs and Inputs, Contacts

Output current I1, I2	Separately adjustable current outputs
Contact K4	Failure signaling
Contacts K3, K2, K1	Separately adjustable relay contacts
Inputs OK1, OK2	Optocoupler signal inputs

**Note:** The menu may vary depending on the device version

1) Only with Protos II 4400(X)

# Parameter Setting Menu



## PH 3400(X)-033 module

### Input filter

- |  |  |
|--|--|
| <ul style="list-style-type: none"> <li>• Sensor data</li> <li>• Sensor type</li> <li>• Temperature detection</li> <li>• Sensoface</li> <li>• Sensor monitoring details</li> <li>- Slope</li> <li>- Zero point</li> <li>- Sensocheck ref. el.</li> <li>- Sensocheck glass el.</li> <li>- Response time</li> <li>- Calcheck</li> </ul> | <p>Representation of measured values on the display:</p> <ul style="list-style-type: none"> <li>- Select</li> <li>- Selection for Measurement / Calibration</li> </ul> |
|--|--|

### Cal preset values

- Calimatic buffer
- Mettler-Toledo
- Knick CaliMat
- DIN 19267
- NIST standard
- NIST technical
- Hamilton
- Kraft
- Hamilton A/B
- HACH
- Ciba
- Reagecon
- Table
- Drift check
- Calibration timer
- Tolerance adjustment
- ORP check

TC process medium	Select: Off, linear, ultrapure water, table
-------------------	---

### ORP/rH value

- Reference electrode
- Calculate rH with factor

### Delta function

### Messages

- pH value
- ORP value
- rH value
- Temperature
- mV value

Note: The menus may vary depending on the device version.

Note: The menus may vary depending on the device version.

## Calibration Menu



### PH 3400(X)-033 module

Calimatic  
 Entry of buffer values  
 Product calibration  
 Data entry  
 Nominal zero  
 Temp probe adjustment      Compensating for lead length (with Protos II 4400(X))

## Maintenance Menu



### BASE module

Current source      Output current definable 0 ... 22 mA

### PH 3400(X)-033 module

Sensor monitor      pH / ORP input, RTD, Temp, Impedance glass + ref. el.  
 Temp probe adjustment      Compensating for lead length (with Protos 3400(X))

## Diagnostics Menu



Message list      List of all warning and failure messages  
 Point of meas description  
 Logbook  
 Device description      Hardware version, Serial no., (module) Firmware, Options

### FRONT module

Module diagnostics  
 Display test  
 Keypad test

### BASE module

Module diagnostics  
 Input/output status

### PH 3400(X)-033 module

Module diagnostics      Internal function test  
 Sensor monitor      Shows the values currently measured by the sensor  
 Cal record      Data of last adjustment / calibration  
 Sensor diagram      Graphical representation of the sensor parameters  
 Statistics      Displays first calibration and deviations of last 3 calibrations

# Index

---

Protos PH 3400(X)-033 Module

## A

Adaptive calibration timer 61  
Adjusting the temperature probe (Protos 3400) 57  
Adjusting the temperature probe (Protos II 4400) 30  
Adjustment 15  
Administrator level 32  
Appendix 77  
Application in hazardous locations 7  
Automatic buffer recognition (Calimatic) 20  
Automatic temperature compensation 17

## B

Behavior during messages 56  
Bilinear characteristic 54  
Buffer table 91  
Buffer tables 78  
Buffer values, manual entry for calibration 22

## C

Calculation Blocks 47  
Calibration 14  
Calibration by entering data from premeasured electrodes 26  
Calibration methods 16  
Calibration timer 61  
Calibration with sampling 24  
Calimatic 20  
Cal preset values 39  
Cal record 62  
Connecting the module 11  
Contacts, parameter setting 56  
Corrective maintenance 7  
Current outputs 53  
Current outputs, characteristics 54  
Current outputs, minimum spans 77



# Index

---

Protos PH 3400(X)-033 Module

## D

Data entry of premeasured electrodes 26  
Delta function 46  
Determination of nominal zero 28  
Device description 59  
Device firmware 8  
Device limits max. 52  
Diagnostic functions 58  
Diagnostic messages 66  
Diagnostic messages as favorite 64  
Disposal 2

## E

Electrostatic discharge (ESD) 11  
EMC 76  
ESD shield 11  
Explosion protection, safety instructions 7

## F

Factory setting 50  
Favorites 64  
Firmware version 8  
First Calibration 16  
Function control matrix 64

## H

Hardware/Firmware version 8

## I

Installing the module 11  
Intended use 6  
Isothermal potential 27

# Index

---

Protos PH 3400(X)-033 Module

## L

- Linear characteristic 54
- Lock icon 33
- Locking a function 33
- Logarithmic output curve 55
- Logbook, diagnostics menu 58
- Logbook (parameter setting) 50

## M

- Maintenance menu 57
- Manual entry of buffer values 22
- Manual temperature compensation 17
- Message icons 52
- Message list 66
- Messages, overview 67
- Messages with Protos 3400(X) 67
- Messages with Protos II 4400(X) 70
- Minimum spans for current outputs 77
- Module compatibility 8
- Module diagnostics 60
- Module firmware 8
- Module installation 11
- Monitoring functions for calibration 27

## N

- Nominal zero 28

## O

- One-point calibration 16
  - Open parameter setting 34
  - Operating levels 32
  - Operator level 32
  - Optocoupler inputs 56
  - ORP/rH value 46
  - Output filter 56
  - Overview of parameter setting 92
-

# Index

---

Protos PH 3400(X)-033 Module

## P

Parameter setting 31  
Parameter setting: Cal preset values 39  
Parameter setting: ORP/rH value 46  
Parameter setting, overview 92  
Parameter setting: Sensor data 35  
Product calibration 24

## R

Rated operating conditions 76  
Release (softkey function) 33  
Restore factory setting 50  
Restore factory settings 50  
Returns 2

## S

Safety Instructions 7  
Screw clamp connector 76  
Secondary displays 64  
Sensoface criteria 38  
Sensor diagram 62  
Sensor monitor, diagnostics menu 60  
Sensor monitor, maintenance menu 57  
Serial number, display 8  
Softkeys, function control 64  
Specifiable buffer sets 91  
Specifications 73  
Start (4 mA) and end (20 mA) 53  
Statistics 62

# Index

---

Protos PH 3400(X)-033 Module

## T

- Table of contents 3
- T-band recorder 61
- TC process medium 43
- Technical data 73
- Temperature compensation during calibration 17
- Temperature compensation of process medium 45
- Temp probe adjustment (Protos 3400) 57
- Temp probe adjustment (Protos II 4400) 30
- Terminal plate 9
- Three-point calibration 16
- Tolerance adjustment 39
- Trademarks 2
- Trilinear characteristic 54
- Two-point calibration 16

## V

- Variable limits 52
- Viewing level 32

## W

- Wiring examples 12

## Z

- Zero point for Pfudler probes 28

---



**Knick**  
**Elektronische Messgeräte**  
**GmbH & Co. KG**

**Headquarters**

Beuckestraße 22 • 14163 Berlin

Germany

Phone: +49 30 80191-0

Fax: +49 30 80191-200

info@knick.de

www.knick.de

**Local Contacts**

www.knick-international.com

Copyright 2019 • Subject to change

Version: 10

This document was published on September 30, 2019.

The latest documents are available for download on our website  
below the corresponding product description.

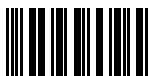

095251

TA-201.033-KNE10

Firmware version: 2.x