

# Protos II 4400(X) / Protos 3400(X) Process Analysis System

User Manual

**Protos OXY 3400(X)-067 Measuring Module**  
For (Trace) Oxygen Measurement in Liquids and Gases

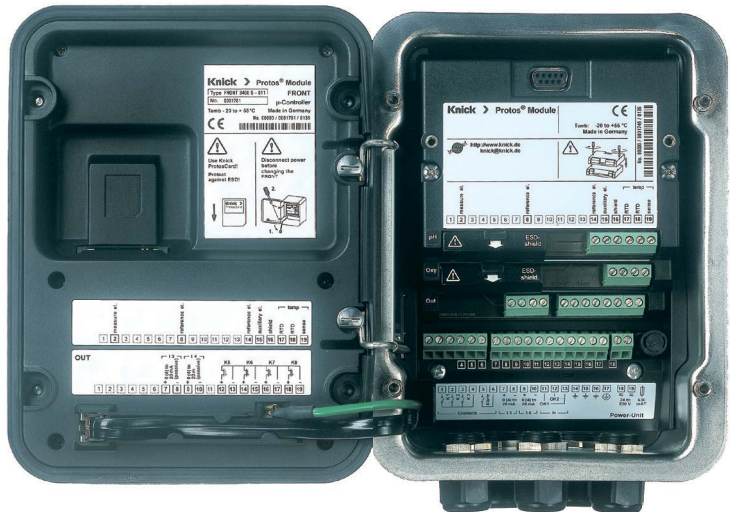

## **Returns**

Clean and securely package the product before returning it to Knick Elektronische Messgeräte GmbH & Co. KG if required.

If there has been contact with hazardous substances, the product must be decontaminated or disinfected prior to shipment. The consignment must always be accompanied by a corresponding return form to prevent service employees being exposed to potential hazards.

Further information can be found at [www.knick.de](http://www.knick.de).

## **Disposal**

The local codes and regulations must be observed when disposing of the product.

# Table of Contents

---

Protos OXY 3400(X)-067 Module

Returns .....	2
Disposal .....	2
<b>Intended Use .....</b>	<b>5</b>
<b>Safety Instructions .....</b>	<b>6</b>
Operation in Explosive Atmospheres: COND 3400X-067 Module .....	6
<b>Firmware Version .....</b>	<b>7</b>
<b>ISM – Intelligent Sensor Management .....</b>	<b>8</b>
Plug and Measure .....	9
First Adjustment .....	10
Parameter Setting .....	11
Predictive Maintenance .....	12
Diagnostics .....	13
CIP (Cleaning in Place) / SIP (Sterilization in Place) .....	15
<b>Terminal Plate OXY 3400-067 Module.....</b>	<b>16</b>
<b>Installing the Module.....</b>	<b>17</b>
<b>Wiring .....</b>	<b>18</b>
<b>Calibration / Adjustment .....</b>	<b>19</b>
Recommendations for Calibration.....	21
HOLD Function During Calibration .....	22
Automatic Calibration in Water.....	24
Automatic Calibration in Air.....	26
Product Calibration (Calibration with Sampling) .....	28
Data Entry of Premeasured Sensors .....	30
Zero Correction .....	31
Temp Probe Adjustment.....	32
<b>Parameter Setting .....</b>	<b>33</b>
Parameter Setting: Operating Levels .....	34
Parameter Setting: Locking a Function .....	35
Setting the Sensor Data Parameters .....	37
Sensoface .....	42
Calculation Blocks .....	43
Logbook.....	45

# Table of Contents

---

Protos OXY 3400(X)-067 Module

Restore Factory Settings.....	45
Messages: Default settings and selection range.....	46
Device limits.....	46
Configuring a Current Output.....	48
Current Outputs: Characteristics.....	49
Current Outputs: Output Filter.....	51
<b>Maintenance .....</b>	<b>53</b>
Temp probe adjustment.....	53
<b>Diagnostic Functions .....</b>	<b>54</b>
Point of Meas Description.....	54
Logbook.....	54
Device Description .....	55
FRONT Module .....	55
BASE Module.....	55
Module Diagnostics.....	56
Sensor Monitor.....	56
Calibration/Adjustment Record.....	57
Temp. Offset Log .....	57
Sensor Diagram .....	57
Statistics.....	57
Setting Diagnostic Messages as Favorite .....	58
Message list .....	60
<b>Specifications.....</b>	<b>69</b>
<b>Appendix:.....</b>	<b>72</b>
Minimum Spans for Current Outputs.....	72
Dissolved Oxygen Measurement in Carbonated Beverages (Only with Protos 3400(X): SW3400-011) .....	73
<b>Overview .....</b>	<b>74</b>
Overview of Parameter Setting.....	74
<b>Index.....</b>	<b>78</b>

# Intended Use

---

The module is an input module for measuring oxygen in liquids and gases. It measures the partial pressure of oxygen, air pressure, and temperature simultaneously with analog amperometric oxygen sensors or amperometric ISM sensors. It is also able to calculate and display the oxygen saturation index and concentration as well as volume concentration in gases.

The OXY 3400X-067 module is intended for operation in locations subject to explosion hazards which require equipment of Group II, device category 2(1), gas/dust.

# Safety Instructions

---

## **Operation in Explosive Atmospheres: COND 3400X-067 Module**

The module is approved for operation in explosive atmospheres.

When installing the product in a hazardous location, observe the information in the supplements to the certificates and, if applicable, the relevant control drawings.

Observe all applicable local and national codes and standards for the installation of electrical equipment in explosive atmospheres. For orientation, please refer to IEC 60079-14, EU directives 2014/34/EU and 1999/92/EC (ATEX), NFPA 70 (NEC), ANSI/ISA-RP12.06.01.

**⚠ WARNING!** Possible impairment of explosion protection.

- Modules which have already been used shall be subjected to a professional routine test before they may be operated in another type of protection.
- Prior to commissioning, the operating company must verify the intrinsic safety in accordance with the installation regulations of IEC 60079-14 for the complete interconnection of all equipment involved, including the connecting cables.
- The interconnection of Ex and non-Ex modules (mixed assembly) is not permitted.
- In hazardous locations the device shall only be cleaned with a damp cloth to prevent electrostatic charging.

## **Maintenance**

The Protos modules cannot be repaired by the user. For inquiries regarding module repair, please contact Knick Elektronische Messgeräte GmbH & Co. KG at [www.knick.de](http://www.knick.de).

# Firmware Version

**Module Firmware OXY 3400(X)-067:** firmware version 3.x

Module Compatibility	OXY 3400-067	OXY 3400X-067
Protos 3400 from FRONT firmware version 7.0	x	
Protos 3400X from FRONT firmware version 7.0		x
Protos II 4400 from FRONT firmware version 01.00.00	x	
Protos II 4400X from FRONT firmware version 01.00.00		x

Further information on the firmware version history can be found at [www.knick.de](http://www.knick.de).

## Query Device Firmware/Module Firmware

When the device is in measuring mode:

Press **menu** key, open Diagnostics menu: Device Description

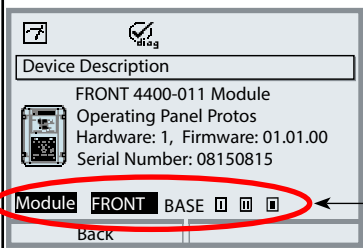
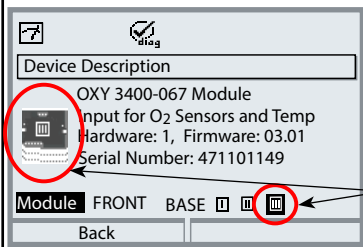
Menu	Display	Action
 diag	 <p>Device Description</p> <p>FRONT 4400-011 Module Operating Panel Protos Hardware: 1, Firmware: 01.01.00 Serial Number: 08150815</p> <p>Module FRONT BASE [ ] [ ] [ ]</p> <p>back</p>	<p><b>Device hardware and firmware version</b></p> <p>Provides information on all modules installed: Module type and function, serial number, hardware and firmware version and device options.</p> <p>Select the different modules (FRONT, BASE, slots 1 - 3) using the arrow keys.</p>
	 <p>Device Description</p> <p>OXY 3400-067 Module Input for O2 Sensors and Temp Hardware: 1, Firmware: 03.01 Serial Number: 471101149</p> <p>Module FRONT BASE [ ] [ ] [ OXY ]</p> <p>Back</p>	<p><b>Query module firmware</b></p> <p>Module OXY 3400-067, hardware and firmware version, serial number – here installed in slot 3.</p>

Note: The display may vary depending on the device version.

# ISM – Intelligent Sensor Management

---

The module allows the connection of ISM sensors.

ISM sensors have an “electronic datasheet” which allows the storage of additional operating parameters such as calibration date and settings directly in the sensor.

After being connected to the measuring module, the ISM sensor is recognized and is ready for measurement.

## Information Available in the ISM Sensor

The following information is stored in the sensor: manufacturer, production date, sensor description, application data and original calibration data, as well as information on predictive maintenance such as the load index and number of CIP/SIP cycles.

Statistical data inform on the product life cycle of the sensor: data of the last 3 calibrations, adjustment record, media values, partial pressure, temperature, response time, impedance, barometric pressure.

## Diagnostics Features:

- Load diagram<sup>1)</sup>
- Wear indication
- Membrane replacement
- Interior body replacement
- Statistics

## Taking over the minimum/maximum temperature

The maximum temperature range is stored in the ISM sensor. When "Sensor monitoring Auto" has been selected, the value pair for the maximum + minimum temperature is automatically taken over from the sensor.



# ISM

## Plug and Measure

An ISM sensor is immediately identified after being connected:

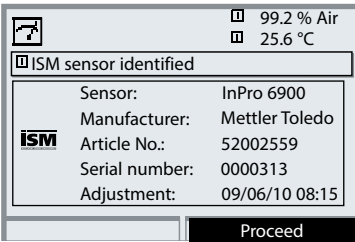

All sensor-typical parameters are automatically sent to the analyzer.

These are, for example, the measuring range, zero and slope of the sensor, but also the type of temperature probe. Without any further parameter setting, measurement starts at once, the measuring temperature is simultaneously detected.

Premeasured ISM sensors can be used for measurement without previous calibration.

The ISM logo is displayed as long as an ISM sensor is connected.

When the ISM sensor has not been adjusted, the “maintenance request” icon is displayed.

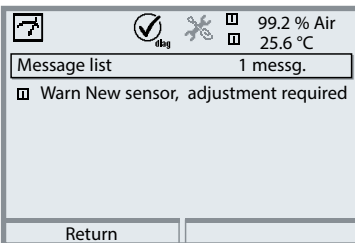
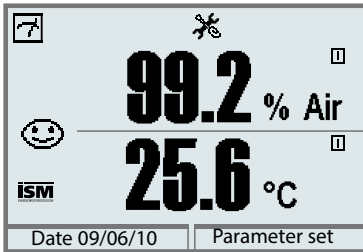

A new entry is added to the message list of the Diagnostics menu:

Warn New sensor, adjustment required

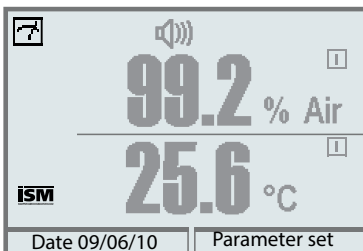

### Failure Message (Incorrect Measured Values)

Measured value, alarm icon, and module slot identifier are flashing.

The flashing means:

**NOTICE!**

The displayed value is no “valid” measured value!

## First Adjustment

Prior to first use, an ISM sensor must be calibrated:

**Note:** The display may vary depending on the device version.

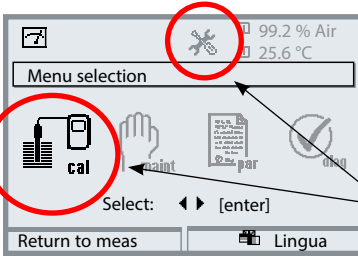

### To open calibration

Press **menu** key to select menu.

The measured values (upper right corner) and the “alarm” and “calibration” icons are flashing. (The analyzer classifies the values as “invalid” because of the missing calibration).

Select calibration using arrow keys, confirm with **enter**. Passcode: 1147.

(To change passcode, select:

Parameter setting/System control/Passcode entry)

After passcode entry, the system is in function check mode: Current outputs and relay contacts behave as configured\* and supply either the last measured value or a fixed value until the Calibration menu is exited.

\* The current outputs / relay contacts are configured in the BASE module or the communication modules (OUT).

The function check (HOLD) mode is indicated by the “Hold” icon (upper left of display).

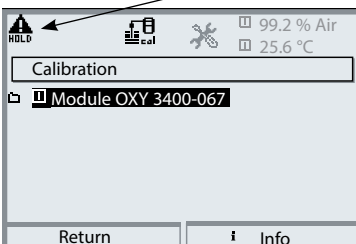

Select module using arrow keys, confirm by pressing **enter**.

Note: The display may vary depending on the device version.

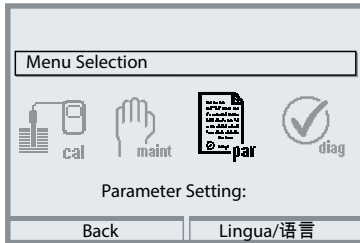

Since ISM sensors have an “electronic datasheet”, many parameters are already provided by the sensor and automatically taken over by the analyzer.

The process-related parameters are specified in the menu

Parameter Setting > OXY 3400(X)-067 Module > ISM Oxy > Sensor Data

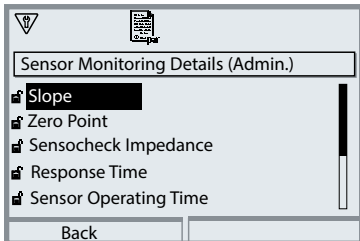
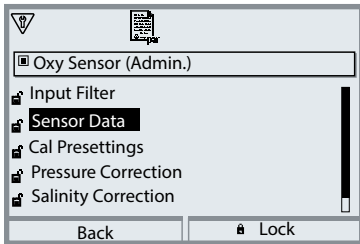

### Sensor Monitoring Details

When an ISM sensor is connected, the values for slope, zero, response time, and temperature range are automatically read by the module. Individual specifications are not overwritten by the ISM data. Additional specifications are required for sensor wear, CIP/SIP counter, auto-claving counter, and sensor operating time. The tolerance limits are displayed in gray.

### Sensor Wear

With Protos 3400(X) and Sensor monitoring details > Load diagram selected, additional specifications can be set here.

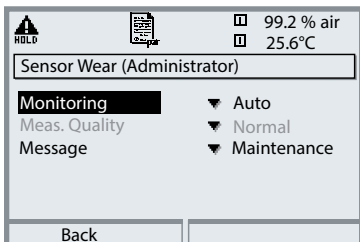

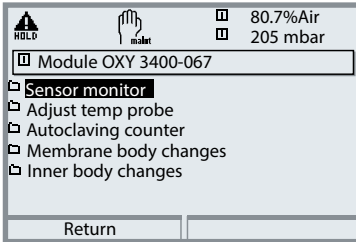

The settings are made in the Maintenance menu > OXY 3400(X)-067 Module > ISM Oxy.

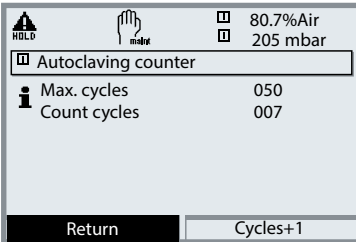

### Autoclaving Counter

When setting the sensor data, the maximum number of autoclaving procedures permitted must be specified. Then, each cycle can be recorded in the Maintenance menu. This shows how many autoclaving cycles are still permitted.

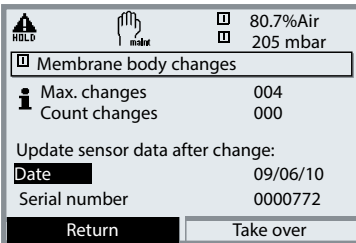

### Membrane Body Changes

During parameter setting, the maximum number of membrane body changes permitted must be specified. Then, each cycle can be recorded in the Maintenance menu (date, serial number). This shows how many changes are still permitted.

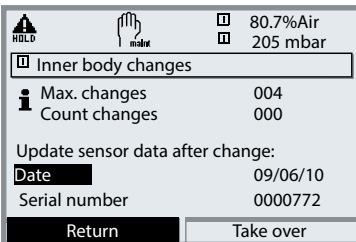

### Inner Body Changes

During parameter setting, the maximum number of membrane body changes permitted must be specified. Then, each change of an inner body can be recorded in the Maintenance menu (date, serial number). This shows how many changes are still permitted.

Note: The display may vary depending on the device version.

Diagnostics menu > OXY 3400(X)-067 Module > ISM Oxy

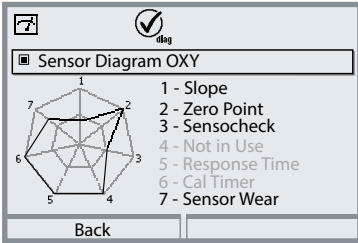

### Sensor Diagram

- Slope
- Zero
- Sensocheck
- Response time
- Cal timer
- Sensor wear

The measured values are continuously monitored during the measurement process. The sensor diagram provides at-a-glance information about critical parameters. If a tolerance limit has been exceeded, the respective parameter is flashing.

Values in gray: Monitoring switched off.

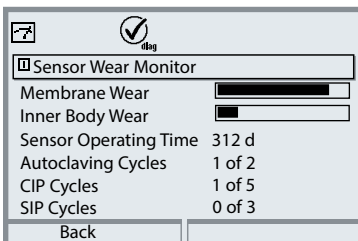
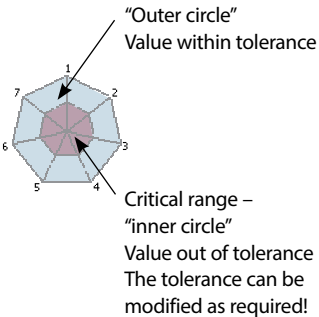

### Sensor Wear Monitor

The Diagnostics menu provides information on the current wear of inner body and membrane body.

Generally, the membrane body must be replaced more often than the inner body:

The "Membrane wear" bargraph shows how much the membrane is worn out.

The inner body wear is not reset when a membrane body has been replaced - here, the load on the inner body is added up and represented as total load on the inner body.

Note: The display may vary depending on the device version.

Note: The display may vary depending on the device version.

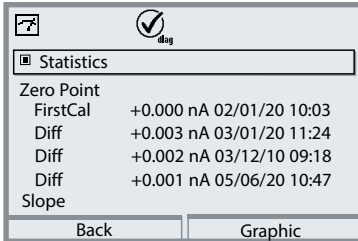

### Statistics

Statistical data inform on the product life cycle of the sensor: Indication of sensor data for the first adjustment and the last three calibrations/ adjustments compared to the first adjustment (date and time of first adjustment, zero and slope, calibration temperature, calibration pressure, response time). These data can be used to evaluate the behavior of the sensor over the operating time.

With the right softkey, you can choose between graphical display and listing.

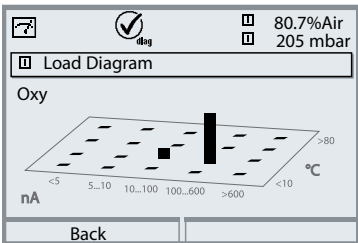

### Load Diagram <sup>1)</sup>

The parameters with "stressing" effect on digital sensors are represented as a 3D matrix. The height of the bar indicates the duration of the load. This way you can see at a glance to what extent the sensor has been exposed to stress. Prerequisite: The "Load matrix" mode has been selected in Parameter setting > Sensor monitoring details, see p. 38.

# CIP/SIP Cycles

---

## CIP (Cleaning in Place) / SIP (Sterilization in Place)

CIP/SIP cycles are used for cleaning or sterilizing the process-wetted parts in the process. They are performed for biotech applications, for example. Depending on the application, one (alkaline solution, water) or more chemicals (alkaline solution, water, acidic solution, water) are used.

The temperatures for CIP are around 80 °C/176 °F, for SIP around 110 °C/230 °F. These procedures extremely stress the sensors. ISM sensors can release a message when a preset number of CIP/SIP cycles is exceeded. This allows replacing the sensor in time.

### Default Values for the Counters (for Evaluating the Sensor Wear):

CIP = 80

SIP = 700

Autoclaving counter = 750 hours for one cycle

### Example of CIP Cycle:

The device automatically recognizes the CIP and SIP cycles and correspondingly increments the counter. The user can specify the max. number of cycles and decide whether a message is to be generated when this number is exceeded.

These data are not overwritten even after sensor replacement.

The number of CIP cycles is shown in the sensor wear monitor of the Diagnostics menu when an individual max value has been specified.

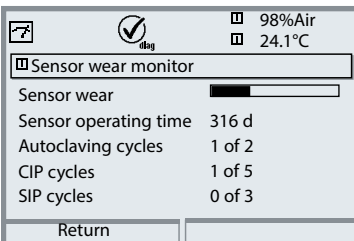

### Note:

The counters are incremented no earlier than 2 hours after start of the cycle, even if the cycle itself has already been terminated.

# Terminal Plate OXY 3400-067 Module

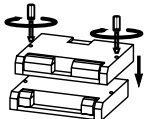
<b>Knick</b> > Protos® Module	<b>CE</b>								
Type <input type="text"/>	<b>OXY</b>	Tamb: -20 to +55 °C							
No. <input type="text"/>	<b>O<sub>2</sub> / °C</b>	Made in Germany							
Internet <a href="http://www.knick.de">www.knick.de</a>									
<b>Oxy sensor</b>									
cathode	anode	reference guard / RTD	temp	shield	ISM	input			
<input type="checkbox"/> 2	<input type="checkbox"/> 8	<input type="checkbox"/> 12	<input type="checkbox"/> 13	<input type="checkbox"/> 14	<input type="checkbox"/> 15	<input type="checkbox"/> 16	<input type="checkbox"/> 17	<input type="checkbox"/> 18	<input type="checkbox"/> 19
								- (0) 4 to + 20 mA	

## Attaching the terminal plates

The terminal plates of the lower modules can be stuck to the inner side of the door. This facilitates maintenance and service.





# Installing the Module

---

**⚠ CAUTION!** Electrostatic discharge (ESD).

The modules' signal inputs are sensitive to electrostatic discharge. Take measures to protect against ESD before inserting the module and wiring the inputs.

**NOTICE!** Strip the insulation from the wires using a suitable tool to prevent damage.



- 1) Switch off the power supply to the device.
- 2) Open the device (loosen the 4 screws on the front).
- 3) Plug the module into the slot (D-SUB connector), see figure.
- 4) Tighten the module's fastening screws.
- 5) Open the ESD shield (covering terminals 2 and 8).
- 6) Connect the sensor and separate temperature probe if necessary, see "Wiring Examples".

**Note:** To avoid interferences, the cable shielding must be completely covered by the ESD shield.

- 7) Fit the ESD shield back into place (covering terminals 2 and 8).
- 8) Check whether all connections are correctly wired.
- 9) Close the device by tightening the screws on the front.
- 10) Switch on the power supply.

**⚠ CAUTION!** Risk of losing the specified ingress protection.

Fasten the cable glands and screw together the housing correctly. Observe the permissible cable diameters and tightening torques (see the specifications of the basic unit).

Insert blanking plugs or sealing inserts if necessary.

# Wiring

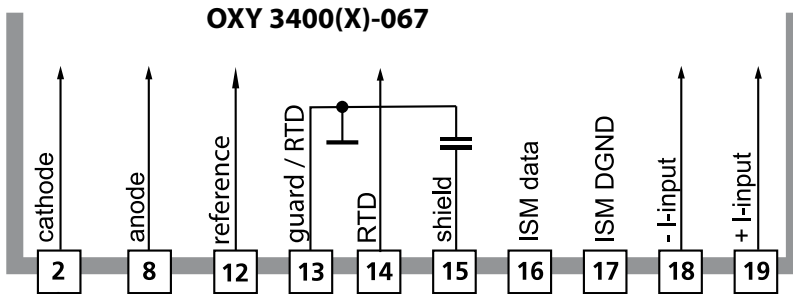

Sensor type	Standard SE 7*6 ... VP6-ST cable	Traces 01 SE 7*7 ... VP6-ST cable	Traces 001 <sup>1)</sup>	ISM
2 cathode	Coax core transparent	Coax core transparent	Coax core transparent	
8 anode	Coax shield Red	Coax shield Red	Coax shield Red	
12 reference		n.c.	Blue	
13 guard/RTD	Gray + Green	Gray + Green	Gray + Green	
14 RTD	White	White	White	
15 shield	Cable shield Yellow/green	Cable shield Yellow/green	Cable shield Yellow/green	
16 ISM data				K8S connection: Coax core (transparent)
17 ISM DGND				K8S connection: Coax shield (black)
18 - I-Input				
19 + I-Input				

The signal from an external pressure transmitter can be fed in through the external current input (18, 19). This enables automatic pressure correction for oxygen measurement.

1) With Protos 3400(X) only

# Calibration / Adjustment

---

**Note:** Function check (HOLD) active for the currently calibrated module  
Current outputs and relay contacts behave as configured

- **Calibration:** Detecting deviations without readjustment
- **Adjustment:** Detecting deviations with readjustment

## **NOTICE!**

Without adjustment every dissolved oxygen meter delivers an imprecise or wrong output value! After replacing the sensor, the electrolyte, or the sensor membrane, you must perform a calibration.

The resulting values must be taken over by an adjustment for calculating the measured variables (measured value display, output signals)!

## **Procedure**

Every dissolved oxygen sensor has its individual slope and zero point. Both values are altered, for example, by aging. For sufficiently high accuracy of oxygen measurement, the meter must be regularly adjusted for the sensor data (adjustment).

## **Replacing the Sensor – First Adjustment <sup>1)</sup>**

After replacement of the sensor or the sensor membrane, a "First Adjustment" should be performed. With the first adjustment, the sensor data are stored as reference values for the statistics.

The "Statistics" menu of Diagnostics shows the deviations of zero, slope, calibration temperature, calibration pressure, and response time of the last three adjustments with respect to the reference values of the first adjustment. This allows evaluation of the drift behavior and aging of the sensor.

## **Calibration/Adjustment Methods**

- Automatic calibration in water/air
- Product calibration (saturation/concentration/partial pressure)
- Data entry
- Zero correction

---

1) ISM with Protos II 4400(X)

# Calibration / Adjustment

## Adjustment

Adjustment means that the values determined by a calibration are taken over. The values determined for zero and slope are entered in the calibration record. (Cal record can be opened in the Diagnostics menu for the module). These values are only effective for calculating the measured variables when the calibration has been terminated with an adjustment. A passcode ensures that an adjustment can only be performed by an authorized person (Administrator). The Operator can check the current sensor data by a calibration and inform the Administrator when there are deviations. You can use the add-on function SW3400-107 <sup>1)</sup> for granting access rights (passcodes) and for AuditTrail (continuous data recording and backup according to FDA 21 CFR Part 11).

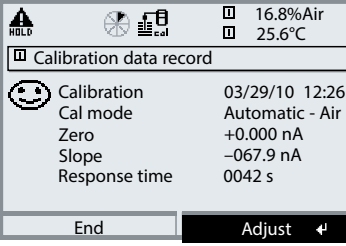
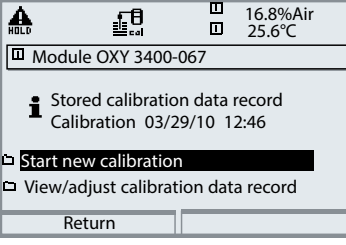
Menu	Display	Action
		<p><b>Administrator</b></p> <p>With the corresponding access rights, the device can immediately be adjusted after calibration. The calibration values are taken over for calculating the measured variables.</p>
		<p><b>Operator</b> (without administrator rights)</p> <p>After calibration, change to measuring mode. Inform Administrator.</p> <p>When opening the menu (Calibration, respective module), the Administrator sees all data of the last calibration and can take over the values or perform a new calibration.</p>

Note: The display may vary depending on the device version.

# Calibration / Adjustment

---

## Recommendations for Calibration

It is always recommended to calibrate in air. Compared to water, air is a calibration medium which is easy to handle, stable, and thus safe. In the most cases, however, the sensor must be dismounted for a calibration in air. In certain processes the sensor cannot be removed for calibration. Here, calibration must be performed directly in the process medium (e.g. with aeration).

For applications where concentration is measured, calibration in air has proved to be useful.

## Common Combination: Process Variable / Calibration Mode

Measurement	Calibration
Saturation	Water
Concentration	Air

If there is a temperature difference between the calibration medium and the measured medium, the sensor must be kept in the respective medium for several minutes before and after calibration in order to deliver stable measured values. The type of calibration pressure detection is preset during parameter setting.

# HOLD Function During Calibration

Behavior of the signal and relay outputs during calibration

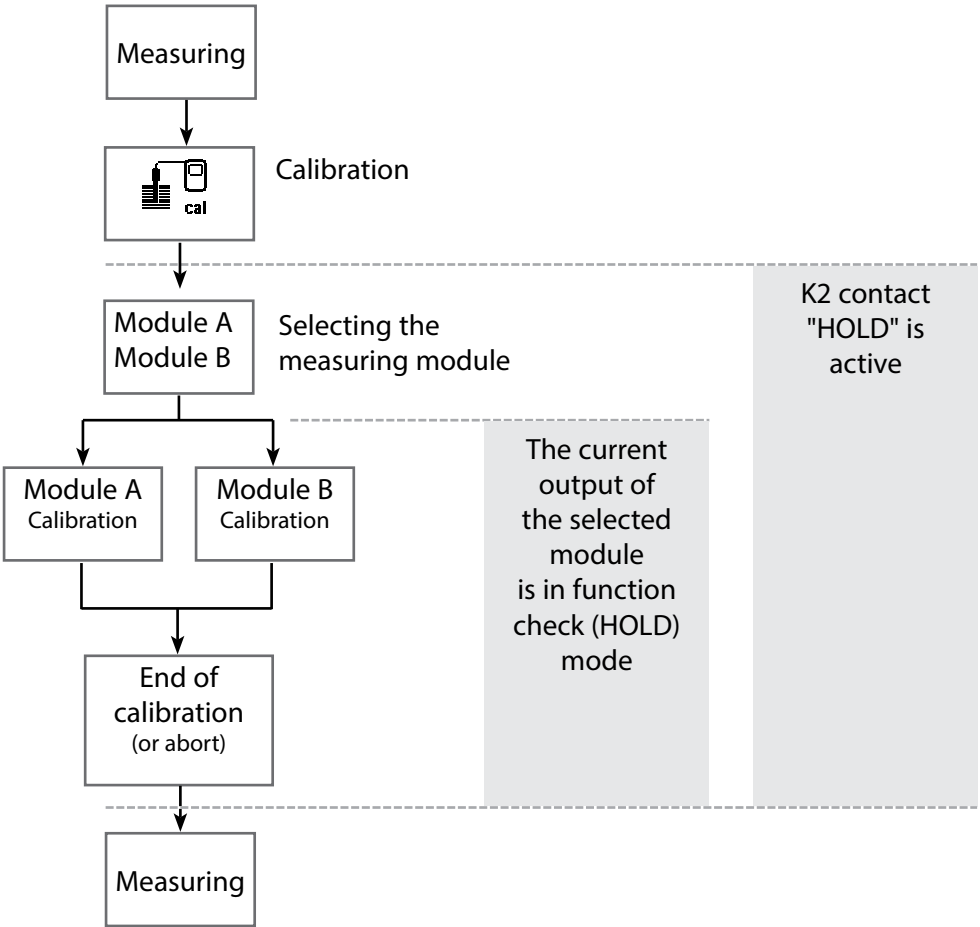

**Note:** The display may vary depending on the device version.

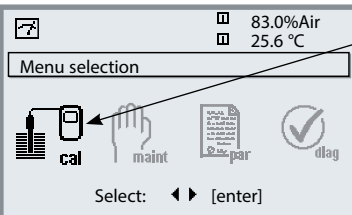
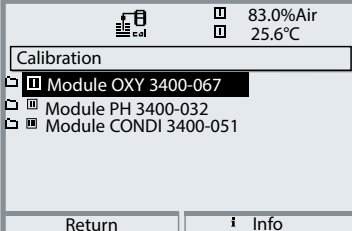
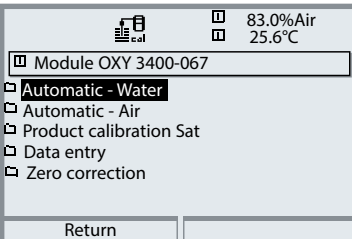
Menu	Display	Action
	  	<p><b>Open calibration</b></p> <p>Press <b>menu</b> key to select menu. Select calibration using arrow keys, press <b>enter</b> to confirm, passcode 1147 (To change passcode, select: Parameter setting &gt; System control &gt; Passcode entry).</p> <p>Calibration: Select "Module OXY"</p> <p>Select a calibration method:</p> <ul style="list-style-type: none"> <li>• Automatic - Water</li> <li>• Automatic - Air</li> <li>• Product calibration Sat (concentration/partial pressure)</li> <li>• Data entry</li> <li>• Zero correction</li> <li>• Temp probe adjustment (with Protos II 4400(X))</li> </ul> <p>When you activate calibration, the analyzer automatically proposes the previous calibration method. If you do not want to calibrate, "Return" with the left softkey.</p> <p><b>During calibration the module is in function check (HOLD) mode.</b> Current outputs and relay contacts behave as configured (BASE module).</p>

# Calibration / Adjustment

## Automatic Calibration in Water

### Automatic Calibration in Water

The slope is corrected using the saturation value (100 %) related to air saturation.

### During calibration the module is in function check (HOLD) mode.

Current outputs and relay contacts of the module behave as configured (BASE module).

### NOTICE!

Ensure sufficient medium flow to the sensor (see Specifications of dissolved oxygen sensors)! The calibration medium must be in equilibrium with air. Oxygen exchange between water and air is very slow. Therefore, it takes a relatively long time until water is saturated with atmospheric oxygen. If there is a temperature difference between calibration medium and measured medium, the sensor must be kept in the respective medium for several minutes before and after calibration.

Note: The display may vary depending on the device version.

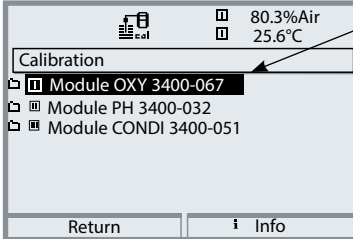
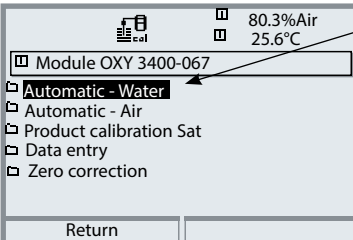
Menu	Display	Select calibration mode
		<p>Select "Module OXY 3400-067" The module is in HOLD mode. Current outputs and relay contacts behave as configured (BASE). Press <b>enter</b> to confirm.</p>
		<p>Select "Automatic - Water" calibration method Remove sensor and immerse it in cal medium (air-saturated water), ensure sufficient medium flow to the sensor. Press <b>enter</b> to confirm.</p>

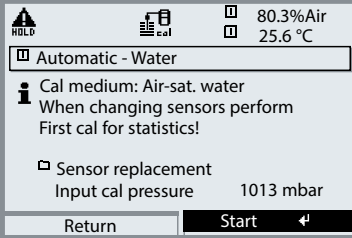
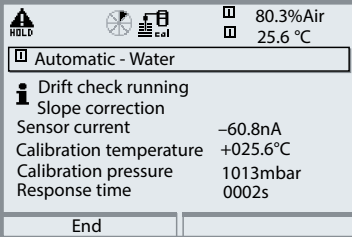
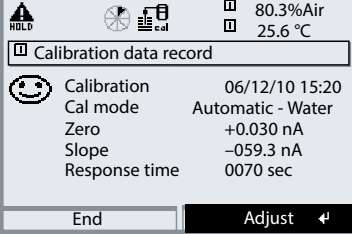

Note: The display may vary depending on the device version.

Menu	Display	Action
	 <p>80.3%Air 25.6 °C</p> <p>Automatic - Water</p> <p>Cal medium: Air-sat. water When changing sensors perform First cal for statistics!</p> <p>Sensor replacement Input cal pressure 1013 mbar</p> <p>Return Start</p>	<p>Display of selected calibration medium (Air-sat. water)</p> <p>Enter cal pressure if "manual" has been configured.</p> <p>Start by pressing softkey or <b>enter</b></p>
	 <p>80.3%Air 25.6 °C</p> <p>Automatic - Water</p> <p>Drift check running Slope correction Sensor current -60.8nA Calibration temperature +025.6°C Calibration pressure 1013mbar Response time 0002s</p> <p>End</p>	<p>Drift check.</p> <p>Display during calibration</p> <ul style="list-style-type: none"> <li>• Sensor current</li> <li>• Calibration temperature</li> <li>• Calibration pressure</li> <li>• Response time</li> </ul> <p>Waiting time can be reduced by pressing <b>enter</b> (without drift check: reduced accuracy of calibration values!). From the response time, you see how long it takes the sensor to deliver a stable signal. If the signal or the measured temperature fluctuate greatly, the calibration procedure is aborted after 2 min. Calibration must be re-started. If successful, place sensor in process, end calibration with softkey or <b>enter</b></p>
	 <p>80.3%Air 25.6 °C</p> <p>Calibration data record</p> <p>Calibration 06/12/10 15:20 Cal mode Automatic - Water Zero +0.030 nA Slope -059.3 nA Response time 0070 sec</p> <p>End Adjust</p>	<p><b>Adjustment</b></p> <p>Press "Adjust" to take over the values determined during calibration for calculating the measured variables.</p>

# Calibration / Adjustment

## Automatic Calibration in Air

### Automatic Calibration in Air

The slope is corrected using the saturation value (100 %), similar to air saturation of water. Since this analogy only applies to water-vapor saturated air (100 % relative humidity) and often the calibration air is less humid, the relative humidity of the calibration air must also be specified. If you do not know the exact value of the relative humidity of the calibration air, you can take the following reference values for a sufficiently precise calibration:

- Ambient air: 50 % rel. humidity (average)
- Bottled gas (synthetic air): 0 % rel. humidity

### NOTICE!

The sensor membrane must be dry. Be sure to keep temperature and pressure constant during calibration. If there is a temperature difference between calibration medium and measured medium, the sensor must be kept in the respective medium for several minutes before and after calibration.

Note: The display may vary depending on the device version.

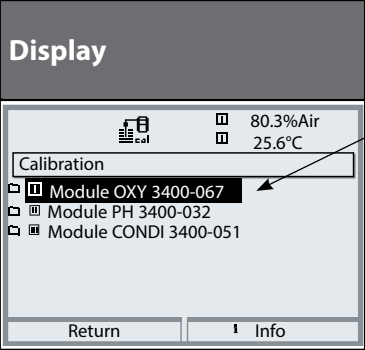
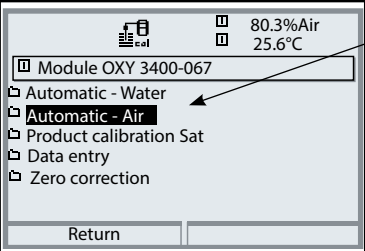
Menu	Display	Action
	 <p>The screenshot shows the 'Calibration' menu with the following options: 'Module OXY 3400-067', 'Module PH 3400-032', and 'Module CONDI 3400-051'. The 'Module OXY 3400-067' option is highlighted. At the top right, the display shows '80.3% Air' and '25.6°C'. At the bottom, there are 'Return' and 'Info' buttons.</p>	Select "Module OXY 3400-067" The module is in function check (HOLD) mode. The assigned current outputs and relay contacts behave as configured (BASE). Press <b>enter</b> to confirm.
	 <p>The screenshot shows the 'Automatic - Air' calibration method selected. The menu options are: 'Automatic - Water', 'Automatic - Air', 'Product calibration Sat', 'Data entry', and 'Zero correction'. The 'Automatic - Air' option is highlighted. At the top right, the display shows '80.3% Air' and '25.6°C'. At the bottom, there is a 'Return' button.</p>	Select "Automatic - Air" calibration method Remove sensor and place it in air. Press <b>enter</b> to confirm.

**Note:** The display may vary depending on the device version.

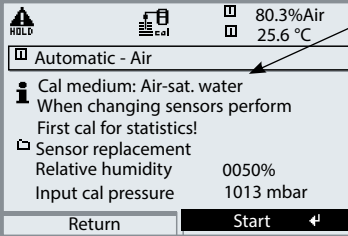
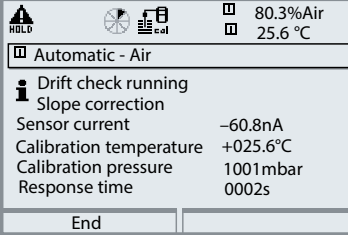
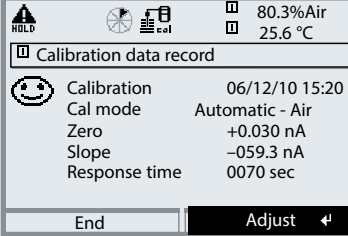
Menu	Display	Action
	 <p>80.3%Air 25.6 °C</p> <p>Automatic - Air</p> <p>Cal medium: Air-sat. water When changing sensors perform First cal for statistics!</p> <p>Sensor replacement Relative humidity 0050% Input cal pressure 1013 mbar</p> <p>Return Start</p>	<p>Cal medium: Air</p> <p>Select: First calibration</p> <p>Enter relative humidity, e.g.:</p> <ul style="list-style-type: none"> <li>Ambient air: 50 %</li> <li>Bottled gas: 0 %</li> </ul> <p>Enter cal pressure if "manual" has been configured.</p> <p>Start by pressing softkey or <b>enter</b>.</p>
	 <p>80.3%Air 25.6 °C</p> <p>Automatic - Air</p> <p>Drift check running Slope correction</p> <p>Sensor current -60.8nA Calibration temperature +025.6°C Calibration pressure 1001mbar Response time 0002s</p> <p>End</p>	<p>Drift check.</p> <p>Display during calibration</p> <ul style="list-style-type: none"> <li>Sensor current, calibration temp, cal pressure and response time.</li> </ul> <p>Waiting time can be reduced by pressing "End" (without drift check: reduced accuracy of calibration values!). From the response time, you see how long it takes the sensor to deliver a stable signal. If the signal or the measured temperature fluctuate greatly, the calibration procedure is aborted after about 2 min. Calibration must be re-started. If successful, replace sensor in the process.</p> <p>End calibration by pressing softkey or <b>enter</b>.</p>
	 <p>80.3%Air 25.6 °C</p> <p>Calibration data record</p> <p>Calibration 06/12/10 15:20 Cal mode Automatic - Air Zero +0.030 nA Slope -059.3 nA Response time 0070 sec</p> <p>End Adjust</p>	<p><b>Adjustment</b></p> <p>Press "Adjust" to take over the values determined during calibration for calculating the measured variables.</p>

# Calibration / Adjustment

Product Calibration (saturation, concentration, partial pressure [hPa, mmHg])  
 Preset in: Parameter setting > Cal preset values/Cal Presettings)

## Product Calibration (Calibration with Sampling)

When the sensor cannot be removed – e.g. for sterility reasons – its slope can be determined with “sampling”. To do so, the currently measured saturation value of the process is stored by the Protos. Directly afterwards, a reference value is determined using a portable meter, for example. The reference value is entered into the measuring system. From the difference between measured value and reference value, the Protos calculates the sensor slope. With low saturation values, the Protos corrects the zero point, with high values the slope.

### During calibration the module is in function check (HOLD) mode.

Current outputs and relay contacts of the module behave as configured (BASE module).

### NOTICE!

The reference value must be measured at temperature and pressure conditions similar to those of the process.

Note: The display may vary depending on the device version.

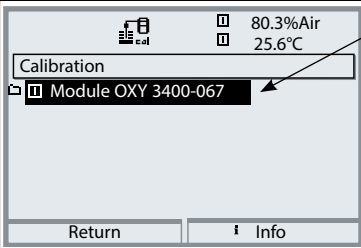
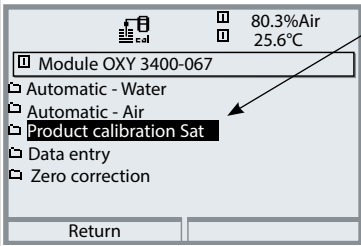
Menu	Display	Action
		<p>Select “Module OXY 3400-067”</p> <p>The module is in function check (HOLD) mode. The assigned current outputs and relay contacts behave as configured (BASE). Press <b>enter</b> to confirm.</p>
		<p>Select “Product calibration” calibration method.</p> <p>Sat (or Conc, p’) is preset in Parameter setting &gt; Cal preset values (Protos II 4400(X): Cal Presettings). Press <b>enter</b> to confirm.</p>

Note: The display may vary depending on the device version.

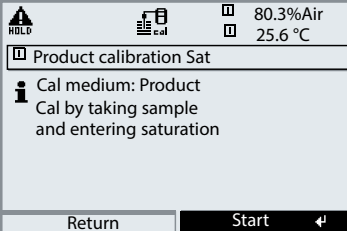
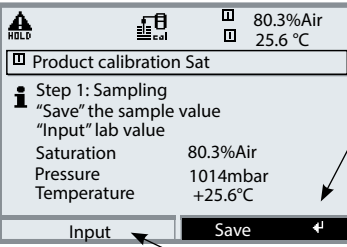
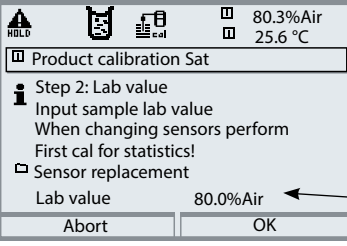
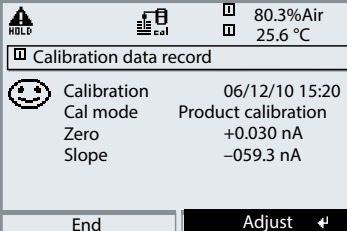
Menu	Display	Action
	 	<p><b>Product calibration Sat</b> Product calibration is performed in 2 steps. Prepare reference measurement (e.g. with portable meter): Start by pressing softkey or <b>enter</b>:</p> <p><b>Step 1</b> Take sample. Store measured value and temperature at the moment of sampling ("Save" softkey or <b>enter</b>) Press <b>meas</b> to return to measurement.</p> <p><b>Exception:</b> Sample value can be measured on the site and be entered immediately. To do so, press "Input" softkey.</p>
		<p><b>Step 2</b> Lab value has been measured. When you open the Product calibration menu again, the display shown on the left appears: Enter reference value ("Lab value"). Confirm with "OK".</p>
		<p><b>Adjustment</b> Press "Adjust" to take over the values determined during calibration for calculating the measured variables.</p>

# Calibration / Adjustment

Data Entry of Premeasured Sensors  
(not required for ISM sensors)

## Data Entry of Premeasured Sensors



Entry of values for slope and zero point of a sensor, related to 25 °C/77 °F, 1013 mbar.

### During calibration the module is in function check (HOLD) mode.

Current outputs and relay contacts of the module behave as configured (BASE module).

Slope = Sensor current at 100 % atmospheric oxygen, 25 °C/77 °F, 1013 mbar

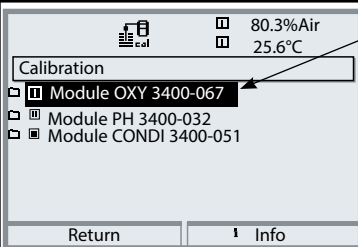
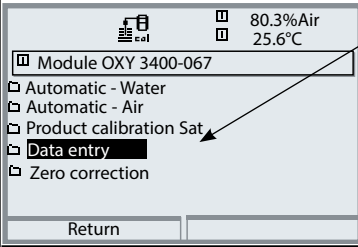
**Note:** The display may vary depending on the device version.

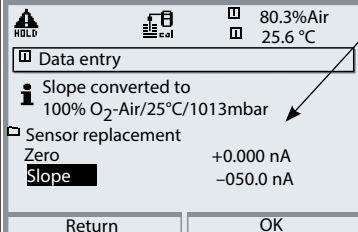
Menu	Display	Action
	 <p>Calibration</p> <ul style="list-style-type: none"> <li>▣ Module OXY 3400-067</li> <li>▣ Module PH 3400-032</li> <li>▣ Module CONDI 3400-051</li> </ul> <p>Return      1 Info</p>	<p>Select "Module OXY 3400-067"</p> <p>The module is in function check (HOLD) mode. The assigned current outputs and relay contacts behave as configured (BASE).</p> <p>Press <b>enter</b> to confirm.</p>
	 <p>Module OXY 3400-067</p> <ul style="list-style-type: none"> <li>▣ Automatic - Water</li> <li>▣ Automatic - Air</li> <li>▣ Product calibration Sat</li> <li>▣ <b>Data entry</b></li> <li>▣ Zero correction</li> </ul> <p>Return</p>	<p>Select "Data entry" calibration method</p> <p>Press <b>enter</b> to confirm.</p>
	 <p>Data entry</p> <p>Slope converted to 100% O<sub>2</sub>-Air/25°C/1013mbar</p> <p>Sensor replacement</p> <p>Zero                    +0.000 nA</p> <p>Slope                   -050.0 nA</p> <p>Return                    OK</p>	<p>Enter the values for</p> <ul style="list-style-type: none"> <li>• Slope</li> <li>• Zero</li> </ul> <p>of premeasured sensor</p> <p>Confirm with "OK".</p>

# Calibration / Adjustment

## Zero Correction

### Zero Correction

The sensor models SE 7\*6 ... and SE7\*7 ... have a very low zero current. For trace measurements below 500 ppb, the zero point should be calibrated. If a zero correction is performed, the sensor should remain for at least 10 to 60 minutes in the calibration medium (media containing CO<sub>2</sub> at least 120 min) to obtain stable, non-drifting values. During zero correction, a drift check is not performed.

Note: The display may vary depending on the device version.

Menu	Display	Action
	<p>Calibration</p> <ul style="list-style-type: none"> <li>Module OXY 3400-067</li> <li>Module PH 3400-032</li> <li>Module CONDI 3400-051</li> </ul> <p>Return    Info</p>	<p>Select "Module OXY 3400-067"</p> <p>The module is in function check (HOLD) mode. The assigned current outputs and relay contacts behave as configured (BASE).</p> <p>Press <b>enter</b> to confirm.</p>
	<p>Module OXY 3400-067</p> <ul style="list-style-type: none"> <li>Automatic - Water</li> <li>Automatic - Air</li> <li>Product calibration Sat</li> <li>Data entry</li> <li>Zero correction</li> </ul> <p>Return</p>	<p>Select "Zero correction" calibration method</p> <p>Press <b>enter</b> to confirm.</p>
	<p>HOLD    80.3%Air    25.6°C</p> <p>Zero correction</p> <p>Direct displacement of sensor zero point</p> <p>Measured sensor current -0.009nA</p> <p>Zero +0.000nA</p> <p>Abort    OK</p>	<p>Zero correction:</p> <p>Display of measured sensor current.</p> <ul style="list-style-type: none"> <li>Enter input current for zero point</li> </ul> <p>Confirm with "OK".</p>

# Calibration / Adjustment

---

## Temp Probe Adjustment

**Note:** With Protos II 4400(X) in the Calibration menu,  
with Protos 3400(X) in the Maintenance menu.

### **Temp Probe Adjustment**

This function allows compensating for the individual temperature probe tolerance and the influence of the lead resistances to increase the accuracy of temperature measurement. Make sure that the process temperature is precisely measured using a calibrated reference thermometer when performing an adjustment. The measurement error of the reference thermometer should be less than 0.1 °C. Adjustment without precise measurement might result in considerable deviations of the measured value display!

With Protos II 4400(X), the data from the last adjustment and the temperature offset can be called from the Diagnostics menu, see p. 57.



# Parameter Setting

**⚠ CAUTION! Incorrect parameter settings or adjustments can result in incorrect outputs.**

The Protos II 4400(X) must therefore be commissioned by a system specialist, all its parameters must be set, and it must be fully adjusted.

## **NOTICE!**

The "function check" (HOLD) mode is active during parameter setting. The behavior of the current outputs depends on the parameter setting, i.e., they may be frozen at the last measurement or set to a fixed value. The red "Alarm" LED blinks.

Measurement operations must not be carried out while the Protos is in the function check (HOLD) mode, as this may put the user at risk due to unexpected system behavior.

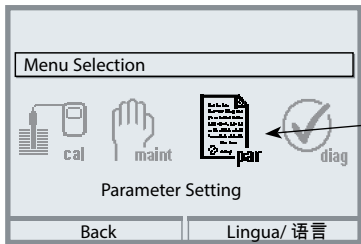
Menü	Display	Action
		<b>Open the Parameter Setting menu</b> From the measuring mode: Press <b>menu</b> key to select menu. Select parameter setting using arrow keys, press <b>enter</b> to confirm

# Parameter Setting: Operating Levels

Viewing level, Operator level, Administrator level

**Note:** Function check (HOLD) mode active (Setting: BASE module)

Note: The display may vary depending on the device version.

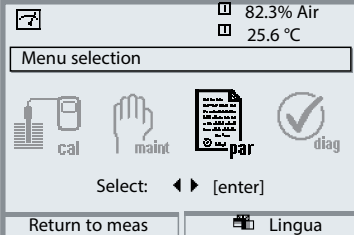
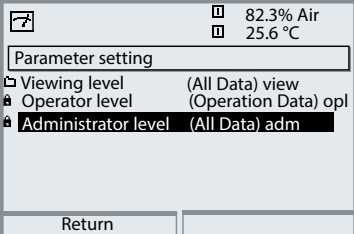
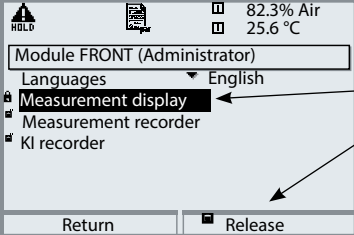
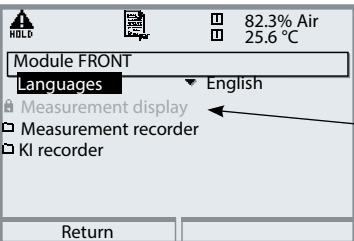

Menu	Display	Action
		<p><b>Open parameter setting</b></p> <p>From the measuring mode: Press <b>menu</b> key to select menu. Select parameter setting using arrow keys, press <b>enter</b> to confirm.</p>
		<p><b>Administrator level</b></p> <p>Access to all functions, also passcode setting. Releasing or blocking a function for access from the Operator level.</p>
		<p>Functions which can be blocked for the Operator level are marked with the "lock" symbol. The functions are released or blocked using the softkey.</p>
		<p><b>Operator level</b></p> <p>Access to all functions which have been released at the Administrator level. Blocked functions are displayed in gray and cannot be edited (Fig.).</p> <p><b>Viewing level</b></p> <p>Display of all settings. No editing possible!</p>

# Parameter Setting: Locking a Function

Administrator level: Enabling/locking functions for Operator level

**Note:** Function check (HOLD) mode active (Setting: BASE module)

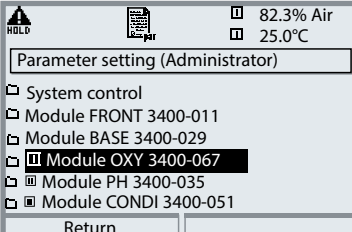
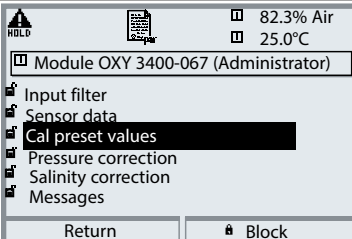
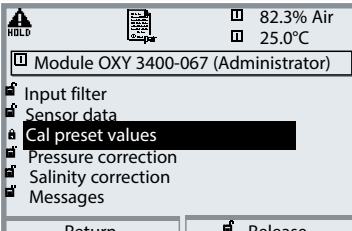
Note: The display may vary depending on the device version.

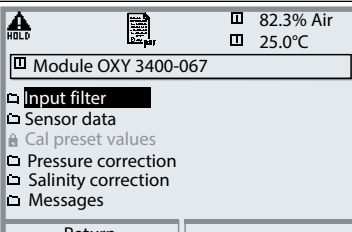
Menu	Display	Action
		<p><b>Example:</b> Blocking access to the calibration adjustments from the Operator level</p> <p><b>Open parameter setting</b>            Select Administrator level.            Enter passcode (1989).            Select "Module OXY" (e.g.) using arrow keys, press <b>enter</b> to confirm.</p>
		<p>Select "Cal preset values" using arrow keys.            "Block" with softkey.</p>
		<p>Now, the "Cal preset values" line is marked with the "lock" icon. This function cannot be accessed from the Operator level any more. The softkey function changes to "Release".</p>
		<p><b>Open parameter setting</b>            Select <u>Operator level</u>, passcode (1246).            Select "Module OXY". Now, the locked function is displayed in gray and marked with the "lock" icon.</p>

# Parameter Setting

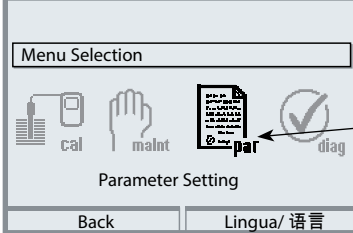
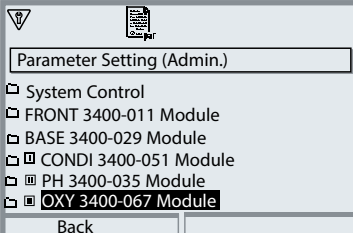
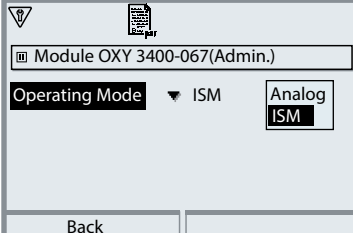
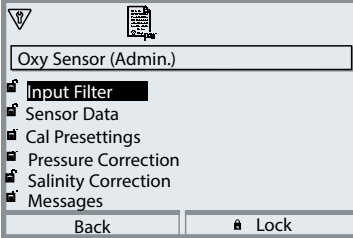
Menu	Display	Action
		<p><b>Opening the parameter setting menu</b></p> <p>From the measuring mode: Press <b>menu</b> key to select menu. Select parameter setting using arrow keys, press <b>enter</b> to confirm.</p>
		<p>Select module, press <b>enter</b> to confirm.</p>
		<p>With Protos II 4400(X): Operating Mode: Analog / ISM Select using arrow keys, press <b>enter</b> to confirm. Press "Back" softkey to return to the parameter selection.</p>
		<p>Select parameter using arrow keys, press <b>enter</b> to confirm.</p>

Note: The display may vary depending on the device version.

**During parameter setting the device is in function check (HOLD) mode:**  
Current outputs and relay contacts behave as configured (BASE module).

# Setting the Sensor Data Parameters

Sensor data: Sensor monitoring details

**Note:** Function check (HOLD) mode active

**Note:** The display may vary depending on the device version.

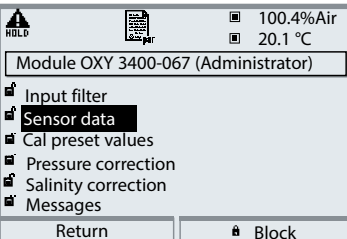
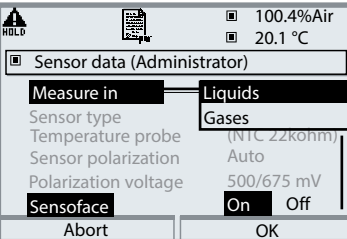
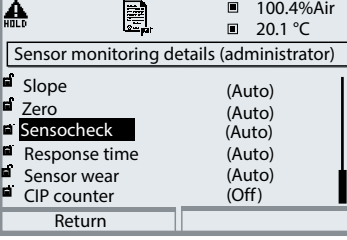
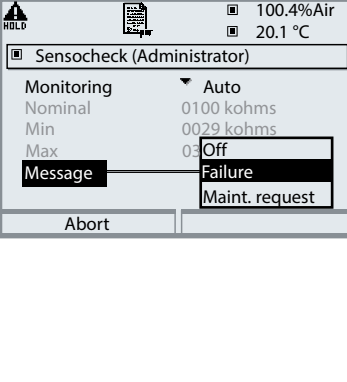
Menu	Display	Action
	 <p>Module OXY 3400-067 (Administrator)</p> <ul style="list-style-type: none"> <li>Input filter</li> <li><b>Sensor data</b></li> <li>Cal preset values</li> <li>Pressure correction</li> <li>Salinity correction</li> <li>Messages</li> </ul> <p>Return      Block</p>	<p><b>Sensor data</b> (see following page)</p> <p>Sensor data are preset depending on the sensor type.</p> <p>Gray display lines cannot be edited.</p>
	 <p>Sensor data (Administrator)</p> <p>Measure in: <b>Liquids</b></p> <p>Sensor type: <b>Gases</b></p> <p>Temperature probe: (NTC 22kohm)</p> <p>Sensor polarization: Auto</p> <p>Polarization voltage: 500/675 mV</p> <p><b>Sensoface</b>: <b>On</b>    Off</p> <p>Abort      OK</p>	<p><b>Sensoface</b> provides information on the sensor condition. Great deviations are signaled. Sensoface can be switched off.</p> <p><b>Sensor monitoring details</b></p> <p>The following parameters are monitored: slope, zero, response time, temperature, for ISM sensors also sensor wear, CIP/SIP counter, autoclaving counter and sensor operating time, membrane and inner body changes. For "Auto", the tolerance limits are displayed in gray. For "Individual", the settings can be specified by the user.</p>
	 <p>Sensor monitoring details (administrator)</p> <ul style="list-style-type: none"> <li>Slope: (Auto)</li> <li>Zero: (Auto)</li> <li><b>Sensocheck</b>: (Auto)</li> <li>Response time: (Auto)</li> <li>Sensor wear: (Auto)</li> <li>CIP counter: (Off)</li> </ul> <p>Return</p>	<p>ISM sensors automatically provide most of the default settings. Individual settings are <u>not</u> overwritten.</p>
	 <p>Sensocheck (Administrator)</p> <p>Monitoring: Auto</p> <p>Nominal: 0100 kohms</p> <p>Min: 0029 kohms</p> <p>Max: 03</p> <p><b>Message</b>: <b>Failure</b></p> <p>Maint. request</p> <p>Abort</p>	<p><b>Message</b></p> <p>Sensocheck can generate a message for failure or maintenance request. It can be seen in the Message list of the Diagnostics menu.</p>

Note: The menus may vary depending on the device version.

Parameter	Default	Selection / Range
<b>OXY 3400-067 Module</b>		
Operating Mode <sup>1)</sup>	Analog	Analog, ISM
<b>Analog Oxy or ISM Oxy <sup>1)</sup></b>		
<b>Input Filter</b>		
Noise Suppression	Weak	Off, Weak, Medium, Strong
Input Filter	010 s	xxx sec (entry)
<b>Sensor Data</b>		
Measure in	Liquids	Liquids, Gases
Sensor Type	Trace Sensor 01	Standard Sensor (SE 7*6 ...), Trace Sensor 01 (SE 7*7 ...), Trace Sensor 001 <sup>2)</sup> , Other or defined by ISM
Monitor Sensor Type	Off	Monitor, Off (for ISM sensor only)
Temperature Probe	NTC 22 kΩ	NTC 30 kΩ, NTC 22 kΩ
Membrane Correction	01.00	
Sensor Polarization	Auto	Auto, Individual
Polarization Voltage	-675 mV	xxxx mV (entry)
Sensoface	Off	Off, Failure, Maint. Required
<b>Sensor Monitoring Details</b>		
<b>Mode <sup>3)</sup></b>	Load Matrix	Load Matrix, DLI Lifetime Indicator
<b>Slope</b>	Auto	Auto, Individual
		<b>Auto: Standard Sensor (SE 7*6...)</b>
		Nominal: -50.0 nA (with ISM sensor: default slope)
		Min.: -110.0 nA (with ISM: min. range)
		Max.: -30.0 nA (with ISM: max. range)
		<b>Auto: Trace Sensor 01 (SE 7*7 ...)</b>
		Nominal: -0375 nA (with ISM sensor: default slope)
		Min.: -0525 nA (with ISM: min. range)
		Max.: -0225 nA (with ISM: max. range)

Note: The menus may vary depending on the device version.

Parameter	Default	Selection / Range
<b>Sensor Monitoring Details (continued)</b>		
		<b>Auto: Trace Sensor 001<sup>2)</sup></b>
		Nominal: -5000 nA (with ISM sensor: default slope)
		Min.: -8000 nA (with ISM: min. range)
		Max.: -2500 nA (with ISM: max. range)
		<b>Auto: Other</b>
		Nominal: -0100 nA (with ISM sensor: default slope)
		Min.: -0900 nA (with ISM: min. range)
		Max.: -0030 nA (with ISM: max. range)
		<b>Individual:</b> permissible range 25 ... 9999 nA
Message Slope	Maint. Required	Off, Failure, Maint. Required
<b>Zero Point</b>	Auto	Auto, Individual
		<b>Auto: Standard Sensor (SE 7*6...)</b>
		Nominal: 0.000 nA
		Min.: -1.000 nA
		Max.: +1.000 nA
		<b>Auto: Trace Sensor 01(SE 7*7 ...)</b>
		Nominal: 0.000 nA
		Min.: -1.000 nA
		Max.: +1.000 nA
		<b>Auto: Trace Sensor 001<sup>2)</sup></b>
		Nominal: 0.000 nA
		Min.: -3.000 nA
		Max.: +3.000 nA
		<b>Auto: Other</b>
		Nominal: 0.000 nA
		Min.: -1.000 nA
		Max.: +1.000 nA
		<b>Individual:</b> permissible range -3.000 ... +3.000 nA
Message Zero	Maint. Required	Off, Failure, Maint. Required

Note: The menus may vary depending on the device version.

Parameter	Default	Selection / Range
<b>Sensocheck</b>	Auto	Auto, Individual
Monitoring of nominal impedance; determined by calibration, taken over by adjustment.		
		<b>Individual</b> allows specifying the values:
		Nominal:        xxxx kΩ
		Min.:            xxxx kΩ
		Max.:            xxxx kΩ
Message Sensocheck	Maint. Required	Off, Failure, Maint. Required
<b>Response Time</b>	Auto	Auto, Individual
		<b>Auto:</b> max. 1200 sec
		<b>Individual:</b> xxxx sec
Message Response time	Maint. Required	Off, Failure, Maint. Required
<b>Temperature</b>	Auto	Auto, Individual
		<b>Auto:</b>
		Min.:            -020.0 °C (with ISM: min. measuring temp)
		Max.:            +150.0 °C (with ISM: max. measuring temp)
		<b>Individual:</b>
		Min.:            xxx.x °C
		Max.:            xxx.x °C
Message Temperature	Maint. Required	Off, Failure, Maint. Required
<b>Sensor Monitoring Details (ISM sensors only)</b>		
Sensor Operating Time	Off	Off, Individual (Enter max. operating time)
Sensor Wear	Auto	Off, Auto, Individual (Enter meas. quality)
TTM Maintenance Timer	Off	Off, Auto, Individual (Enter TTM interval)
DLI Lifetime Indicator	Off	Off, Auto
CIP Counter	Off	Off, Individual (Enter max. CIP cycles)
SIP Counter	Off	Off, Individual (Enter max. SIP cycles)
Autoclaving Counter	Off	Off, Individual (Enter max. autoclaving cycles)
Membrane Body Replacement	Off	Off, Individual (Enter max. changes)
Interior Body Replacement	Off	Off, Individual (Enter max. changes)



Note: The menus may vary depending on the device version.

Parameter	Default	Selection / Range
<b>Cal Presettings</b>		
Product Calibration	%Air	SAt (%Air), Conc (mg/l, µg/l, ppm, ppb), p' (mmHg, mbar)
Calibration Timer		
- Monitoring	Auto	Off, Auto, Individual
- Cal Timer	0000 h	With ISM: Off, Without ISM: Entry (xxxx h)
<b>Pressure Correction</b>		
Pressure Transmitter	Difference	Absolute, Difference
I input	4 ... 20 mA	0 ... 20 mA / 4 to 20 mA
Start 0(4) mA	0000 mbar	xxxx mbar
End 20 mA	9999 mbar	xxxx mbar
Pressure During Meas.	Air Pressure	Air pressure, Manual (default 1013 mbar), External
Pressure During Cal	Air Pressure	Air pressure, Manual (default 1013 mbar), External
<b>Salinity Correction</b>		
Entry	Salinity	Salinity, chlorinity, conductivity (00.00 g/kg or 0.000 µS/cm, depending on selection)
<b>Messages (gas)</b>		
Concentration Messages	Off	Off, Variable Limits
Partial Pressure Messages	Off	Off, Variable Limits
Message Air Pressure	Off	Off, Max. Device Limits, Variable Limits
<b>Messages (liquid)</b>		
Saturation %Air Messages	Off	Off, Variable Limits
Messages Saturation %O <sub>2</sub>	Off	Off, Variable Limits
Concentration Messages	Off	Off, Variable Limits
Partial Pressure Messages	Off	Off, Variable Limits
Message Air Pressure	Off	Off, Max. Device Limits, Variable Limits
<b>Sensor devaluation (ISM)</b>		

# Sensoface 😊

Sensoface is a graphic indication of the sensor condition.

The “smileys” provide information on wear and required maintenance of the sensor (“friendly” - “neutral” - “sad”).

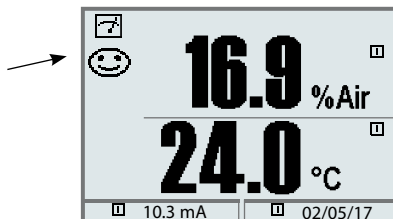

## Sensoface Criteria (adjustable – see Sensor monitoring)

Parameter	Critical range		
	Standard sensor (SE7*6)	Trace sensor 01 (SE 7*7 ...)	Trace sensor 001 <sup>2)</sup>
Slope <sup>1)</sup>	< -110 nA or > -30 nA	< -525 nA or > -225 nA	< -8000 nA or > -2500 nA
Zero	< -1 nA or > 1 nA	< -1 nA or > 1 nA	< -3 nA or > 3 nA
Sensocheck (impedance)	0.3*R or > 3.5*R		
Response time	> 1200 s		
Calibration timer	when 80 % expired		
Sensor wear	as specified (ISM sensors only)		

### Sensocheck:

Monitoring of membrane and electrolyte

1) “Slope”: Sensor current value with oxygen saturation (referred to air), 25 °C, and 1013 mbar normal pressure (nA /100 %). The display only indicates the “nA” symbol. From the technical point of view, it is no “slope” but a calibration point. This value shall allow comparing the sensor with the specifications in the data-sheet.

2) With Protos 3400(X) only

# Calculation Blocks

Select menu: Parameter setting > System control > Calculation Blocks  
Calculation of new variables from measured variables

## Calculation Blocks

Two measuring modules with all their measured values serve as input for the calculation block. In addition, the general device status (NAMUR signals) is taken into account. The difference between the existing values is calculated: These output variables are then available in the system and can be assigned to the outputs (current, limit values, display ...)

## Functionality of Measuring Module

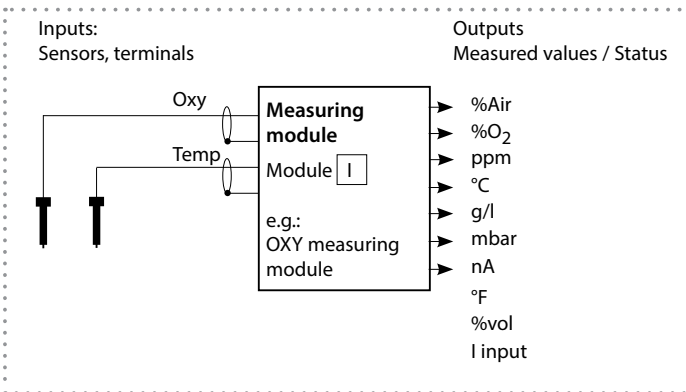

## Functionality of Calculation Block

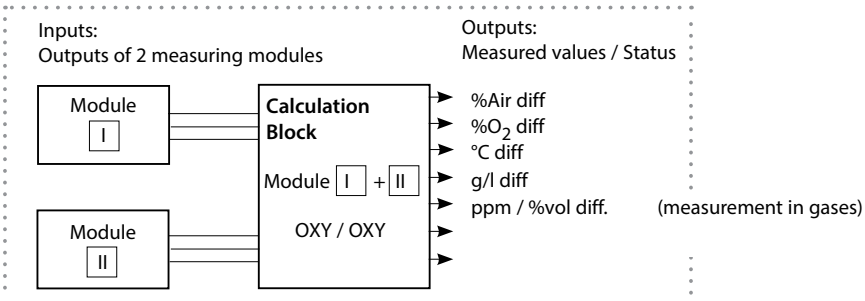

# Activating a Calculation Block

Select menu: Parameter setting > System control > Calculation Blocks

## Combining Measuring Modules

With three measuring modules the following Calculation Block combinations are possible: I + II, I + III, II + III

Up to two Calculation Blocks can be activated.

All current outputs can be set to output the new process variables formed by the Calculation Blocks.

All new process variables can be displayed as primary or as secondary value.

Controller functions are not supported.

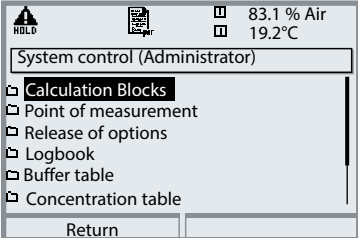
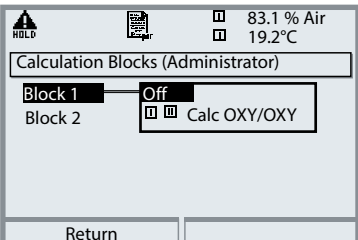
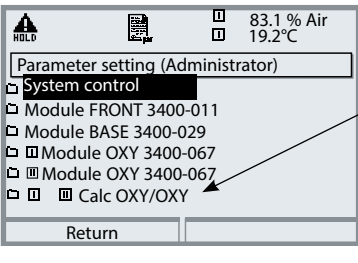
Menu	Display	Action
		<p><b>Calculation Blocks</b></p> <ul style="list-style-type: none"> <li>• Open parameter setting</li> <li>• System control</li> <li>• Select "Calculation Blocks"</li> </ul>
		<p>Depending on the modules installed, the possible combinations for Calculation Blocks are offered.</p>
		<p>During parameter setting the Calculation Blocks are displayed like modules.</p>

Note: The display may vary depending on the device version.

# Parameter Setting

Parameter setting > System control

**Note:** Function check (HOLD) mode active

Note: The display may vary depending on the device version.

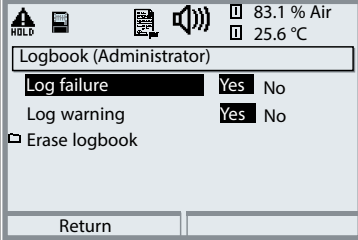
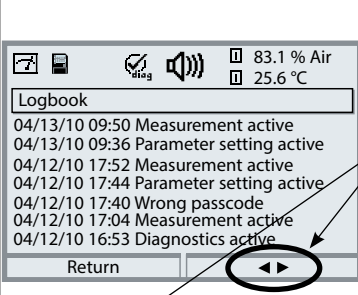
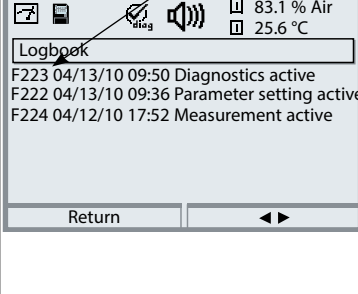
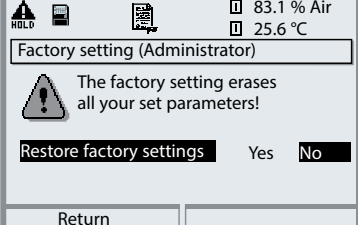
Menu	Display	Action
		<p><b>Logbook</b></p> <p>Select which messages are to be recorded in the logbook.</p> <p>The logbook directly displays the last events with date and time, e.g. calibrations, warning and failure messages, power failure (Protos 3400(X): 50, Protos II 4400(X): 100 events).</p>
		<p>The logbook entries can be called from the Diagnostics menu (Fig.). Pressing the right softkey displays the message identifier.</p>
		<p>SW3400-104: Extended logbook / FW4400-104: Logbook</p> <p>With SmartMedia Card and Protos 3400(X) or Data Card and Protos II 4400(X), max. 50,000 entries (Protos 3400(X)) or min. 20,000 entries (Protos II 4400(X)) can be saved on a memory card.</p>
		<p><b>Restore Factory Settings</b></p> <p>Allows resetting the parameters to their factory setting.</p>

# Parameter Setting

Messages: Default settings and selection range

**Note:** Function check (HOLD) mode active

**Note:** The menus may vary depending on the device version

Parameter	Default	Selection / Range
<b>Messages Gas</b> <ul style="list-style-type: none"> <li>• Concentration</li> <li>• Partial pressure</li> <li>• Air pressure</li> </ul>	Off Off Off	Off, variable limits* Off, variable limits* Off, device limits max., variable limits*
<b>Messages Liquid</b> <ul style="list-style-type: none"> <li>• %Air saturation</li> <li>• %O<sub>2</sub> saturation</li> <li>• Concentration</li> <li>• Partial pressure</li> <li>• Air pressure</li> </ul>	Off Off Off Off Off	Off, variable limits* Off, variable limits* Off, variable limits* Off, variable limits* Off, device limits max., variable limits*
* With "Variable limits" selected, the following parameters can be edited: <ul style="list-style-type: none"> <li>• Failure Limit Lo</li> <li>• Warning Limit Lo</li> <li>• Warning Limit Hi</li> <li>• Failure Limit Hi</li> </ul>		

## Device limits

- Device limits max.    Maximum measuring range of device
- Variable limits:    Range limits specified

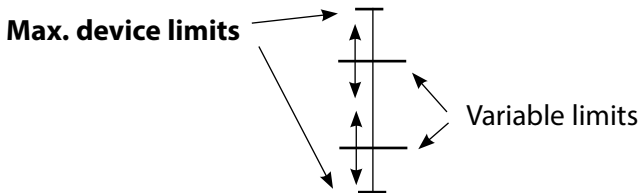





# Parameter Setting

## Messages

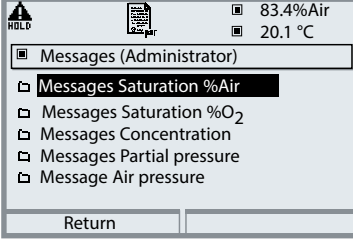
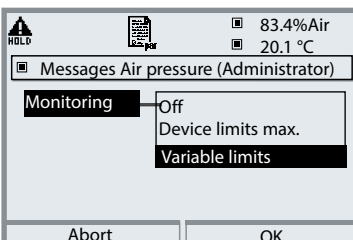
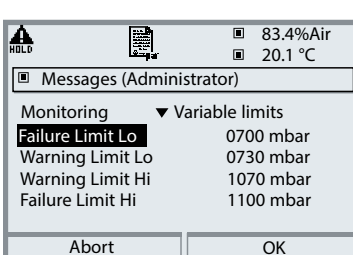
**Note:** Function check (HOLD) mode active

**Note:** The display may vary depending on the device version.

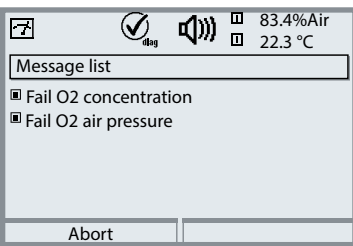
Menu	Display	Action
	  	<h3>Messages</h3> <p>All parameters determined by the measuring module can generate messages.</p> <ul style="list-style-type: none"> <li> <b>Device limits max:</b>            Messages are generated when the process variable (e.g. air pressure) is outside the measurement range. The "Failure" icon is displayed, the NAMUR failure contact is activated (BASE module, factory setting: contact K4, N/C contact). The current outputs can signal a 22 mA message (user defined).         </li> <li> <b>Variable limits:</b>            For the "failure" and "warning" messages you can define upper and lower limits for message generation.         </li> <li> <b>Message icons:</b> <ul style="list-style-type: none"> <li> Failure (Failure limit HiHi/LoLo)</li> <li> Maintenance (Warning limit Hi/Lo)</li> </ul> </li> </ul>
		<h3>Diagnostics menu</h3> <p>When the "Maintenance" or "Failure" icons are flashing in the display, you should call up the Diagnostics menu. The messages are displayed in the "Message list".</p>

# Parameter Setting: BASE Module

Menu selection: Parameter Setting > BASE Module

**Note:** Function check (HOLD) active

Note: The display may vary depending on the device version.

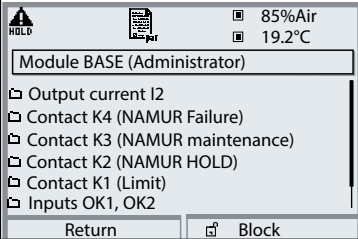
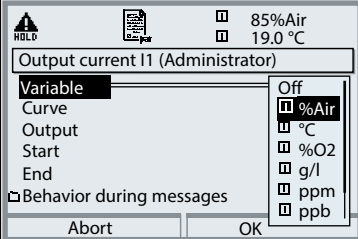
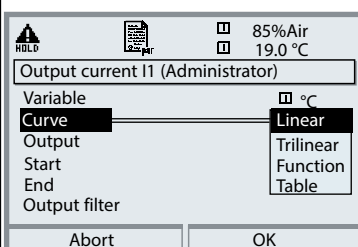
Menu	Display	Action
		<p><b>Configuring a Current Output</b></p> <ul style="list-style-type: none"> <li>• Open parameter setting</li> <li>• Enter passcode</li> <li>• Select "Module BASE"</li> <li>• Select "Output current ..."</li> </ul>
		<ul style="list-style-type: none"> <li>• Select process variable</li> </ul> <p>Gas measurement in %/ppm (Liquids: ppm/ppb) Start and end of current output can be set to the other process variable because also the measured value switches automatically. The decimal point can be moved using the arrow keys.</p>
		<p>Select Curve, e.g. "Linear": The measured variable is represented by a linear output current curve. The desired range of the measured variable is specified by the values for "Start" and "End". See also: "Minimum span"</p>

## Assignment of Measured Values: Start (4 mA) and End (20 mA)

Example 1: Range %Air 50 ... 100

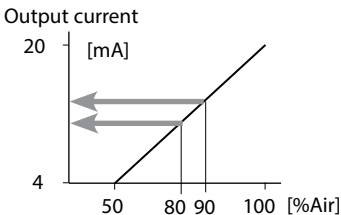

Example 2: Range %Air 80 ... 90

Advantage: Higher resolution in range of interest

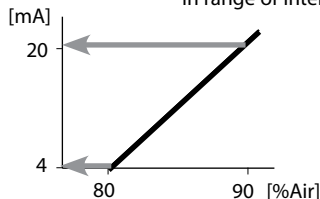



# Current Outputs: Characteristics

---

Menu selection: Parameter setting > BASE module

**Note:** Function check (HOLD) mode active

- **Linear characteristic**

The process variable is represented by a linear output current curve.

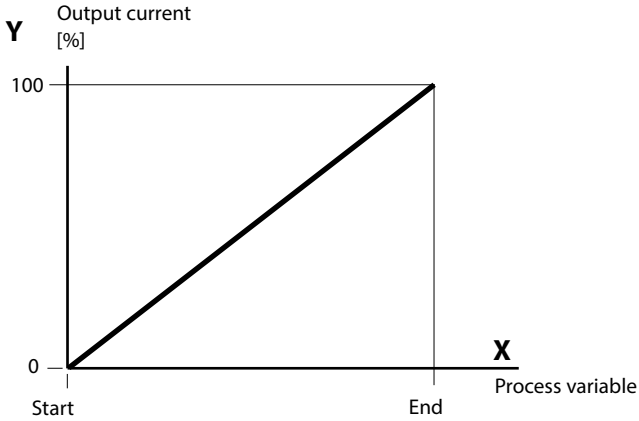

- **Trilinear characteristic**

Two additional vertices must be entered:

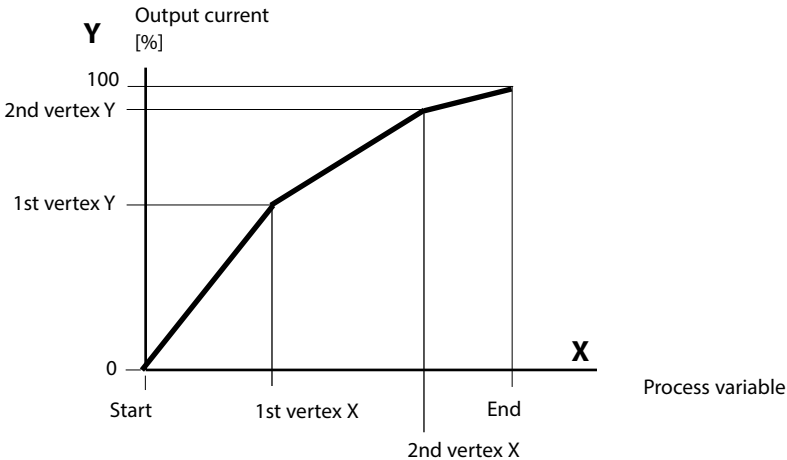

- **Note: Bilinear characteristic**

For a bilinear characteristic, identical parameters are entered for the two vertices (1st vertex, 2nd vertex).

**• Function characteristic**

Nonlinear output current characteristic: allows measurements over several decades, e.g. measuring very low values with a high resolution and high values with a low resolution.

Required: Entering a value for 50 % output current.

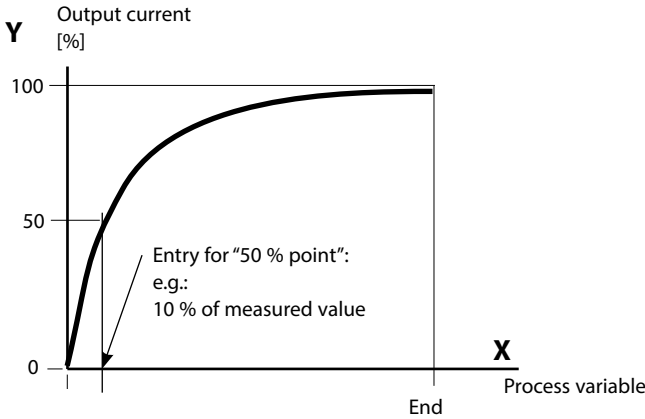

**Equation**

$$\text{Output current (4 to 20 mA)} = \frac{(1+K)x}{1+Kx} 16 \text{ mA} + 4 \text{ mA}$$

$$K = \frac{E + S - 2 * X50\%}{X50\% - S} \qquad x = \frac{M - S}{E - S}$$

- S: Start value at 4 mA
- X50%: 50% value at 12 mA (output current range 4 to 20 mA)
- E: End value at 20 mA
- M: Measured value

**Logarithmic output curve over one decade:**

- S: 10 % of maximum value
- X50%: 31.6 % of maximum value
- E: Maximum value

**Logarithmic output curve over two decades:**

- S: 1 % of maximum value
- X50%: 10 % of maximum value
- E: Maximum value

# Current Outputs: Output Filter

---

Parameter setting > BASE module > Output current I... > Output filter

**Note:** Function check (HOLD) mode active

## Time Averaging Filter

To smoothen the current output, a low-pass filter with adjustable time interval can be switched on. When there is a jump at the input (100 %), the output level is at 63 % after the time interval has been reached.

The time interval can be set from 0 to 120 sec. If the time interval is set to 0 sec, the current output follows the input.

### Note:

The filter only acts on the current output and the current value of the secondary display, not on the measurement display, the limit values or the controller!

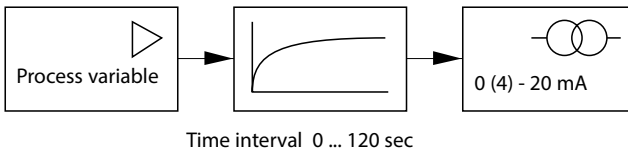

### Note:

For further BASE module settings (behavior during messages, contacts, opto-coupler inputs) refer to the user manual of the basic device.







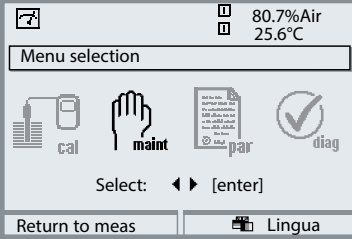

---

# Maintenance

Sensor monitor, temp probe adjustment

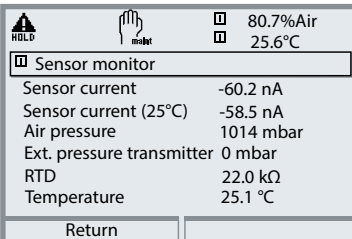
**Note:** Function check (HOLD) mode active

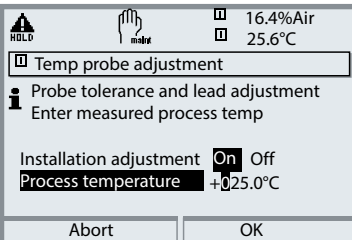
**Note:** The display may vary depending on the device version.

Menu	Display	Action
 <b>maint</b>	 <p>Menu selection</p> <p>Select: ◀ ▶ [enter]</p> <p>Return to meas     Lingua</p>	<p><b>Opening the Maintenance menu</b></p> <p>From the measuring mode: Press <b>menu</b> key to select menu. Select maintenance using arrow keys, confirm with <b>enter</b>. Passcode 2958 (To change passcode: Parameter setting &gt; System control &gt; Passcode entry). Then select "Module OXY".</p>
  <b>maint</b>	 <p><b>Sensor monitor</b></p> <p>Sensor current -60.2 nA Sensor current (25°C) -58.5 nA Air pressure 1014 mbar Ext. pressure transmitter 0 mbar RTD 22.0 kΩ Temperature 25.1 °C</p> <p>Return</p>	<p><b>Sensor monitor</b></p> <p>During maintenance, the sensor monitor allows validation of the sensor by immersing it in a known solution, for example, and checking the values measured.</p>
  <b>maint</b>	 <p><b>Temp probe adjustment</b></p> <p> Probe tolerance and lead adjustment Enter measured process temp</p> <p>Installation adjustment <input checked="" type="checkbox"/> On <input type="checkbox"/> Off Process temperature <b>+0</b>25.0°C</p> <p>Abort    OK</p>	<p><b>Temp probe adjustment</b><sup>1)</sup></p> <p>This function allows compensating for the individual temperature probe tolerance and the influence of the lead resistances to increase the accuracy of temperature measurement. Make sure that the process temperature is precisely measured using a calibrated reference thermometer when performing an adjustment! The measurement error of the reference thermometer should be less than 0.1 °C. Adjustment without precise measurement might result in considerable deviations of the measured value display!</p>

1) With Protos II 4400(X) in the Calibration menu

# Diagnostic Functions

General status information of the measuring system  
Menu selection: Diagnostics

Note: The display may vary depending on the device version.

Menu	Display	Action
		<p><b>Opening the diagnostics menu</b></p> <p>From the measuring mode: Press <b>menu</b> key to select menu. Select diagnostics using arrow keys, confirm by pressing <b>enter</b>.</p>
		<p>The “Diagnostics” menu gives an overview of all functions available. Functions which have been set as “Favorite” can be directly accessed from the measuring mode.</p>
		<p><b>Point of Meas Description</b></p> <p>Allows entering a tag number and a note. Select position: left/right arrow key, select character: up/down arrow key. Confirm the entry by pressing <b>enter</b>.</p>
		<p><b>Logbook</b></p> <p>Shows the last events<sup>1)</sup> with date and time, e.g. calibrations, warning and failure messages, power failure. This permits quality management documentation as required by ISO 9001. For parameter setting, see p. 45.</p>
	<p>☐ Releasing module:</p> <ul style="list-style-type: none"> <li>• Message activated</li> <li>◦ Message deactivated</li> </ul>	

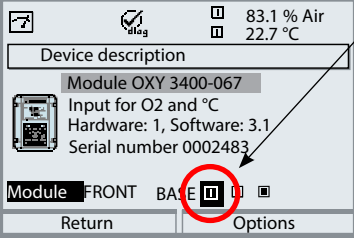
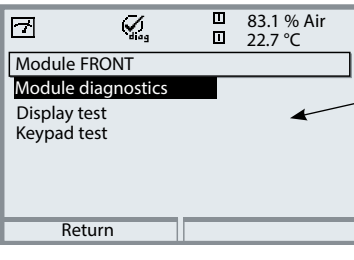
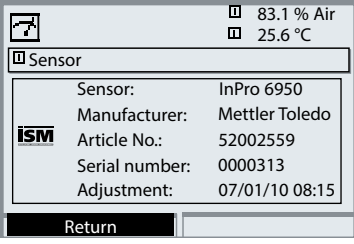
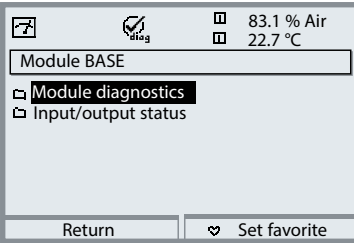
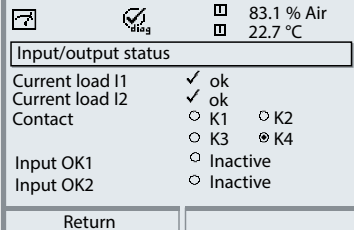

**Note:** The display may vary depending on the device version.

Menu	Display	Action
	 <p>Device description</p> <p>Module OXY 3400-067</p> <p>Input for O2 and °C Hardware: 1, Software: 3.1 Serial number 0002483</p> <p>Module FRONT BASE</p> <p>Return Options</p>	<p><b>Device Description</b></p> <p>Select module using arrow keys: Provides information about all modules installed: Function, serial number, hardware and software version, and device options.</p>
	 <p>Module FRONT</p> <p>Module diagnostics</p> <p>Display test Keypad test</p> <p>Return</p>	<p><b>FRONT Module</b></p> <p>The module contains the display and keypad control. Test possibilities:</p> <ul style="list-style-type: none"> <li>• Module diagnostics</li> <li>• Display test</li> <li>• Keypad test</li> </ul>
	 <p>Sensor</p> <p>Sensor: InPro 6950 Manufacturer: Mettler Toledo Article No.: 52002559 Serial number: 0000313 Adjustment: 07/01/10 08:15</p> <p>Return</p>	<p><b>ISM Sensor Description*</b></p> <p>Information on sensor type, manufacturer, article no., serial number, date of last adjustment</p> <p>* Menu is only displayed for ISM modules when a valid ISM sensor is connected.</p>
	 <p>Module BASE</p> <p>Module diagnostics</p> <p>Input/output status</p> <p>Return Set favorite</p>	<p><b>BASE Module</b></p> <p>The module generates the standard output signals. Test possibilities:</p> <ul style="list-style-type: none"> <li>• Module diagnostics</li> <li>• Input/output status</li> </ul>
	 <p>Input/output status</p> <p>Current load I1 ✓ ok Current load I2 ✓ ok Contact ○ K1 ○ K2 ○ K3 ⊗ K4 Input OK1 ○ Inactive Input OK2 ○ Inactive</p> <p>Return</p>	<p>Example: Module BASE, input/output status.</p>

# Diagnostic Functions

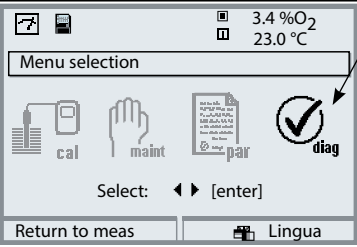

Menu selection: Diagnostics > OXY ... Module

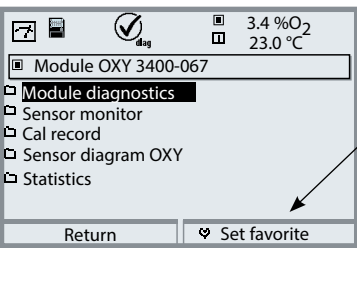
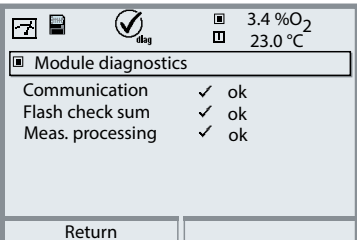
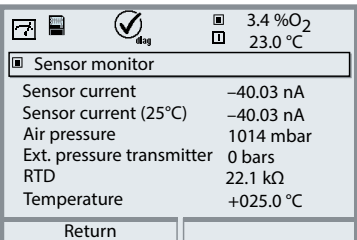
Note: The display may vary depending on the device version.

Menu	Display	Action
	 <p>The screenshot shows the menu selection interface. At the top, it displays '3.4 %O<sub>2</sub>' and '23.0 °C'. Below this is a 'Menu selection' header. There are four icons: 'cal', 'maint', 'par', and 'diag'. The 'diag' icon is highlighted with a checkmark. Below the icons, it says 'Select: ◀ ▶ [enter]'. At the bottom, there are two buttons: 'Return to meas' and 'Lingua'.</p>	<p><b>Open the diagnostics menu</b></p> <p>From the measuring mode: Press <b>menu</b> key to select menu. Select diagnostics using arrow keys, confirm by pressing <b>enter</b>. Then select Module OXY.</p>
	 <p>The screenshot shows the 'Module OXY 3400-067' diagnostics menu. At the top, it displays '3.4 %O<sub>2</sub>' and '23.0 °C'. Below this is a 'Module diagnostics' header. There are four sub-menus: 'Sensor monitor', 'Cal record', 'Sensor diagram OXY', and 'Statistics'. The 'Sensor monitor' sub-menu is highlighted. At the bottom, there are two buttons: 'Return' and 'Set favorite'.</p>	<p>The Diagnostics menu gives an overview of all diagnostic functions available. <u>Messages</u> set as "Favorite" can be called directly from the measuring mode using a softkey. To configure: Parameter setting &gt; System control &gt; Function control matrix.</p>
	 <p>The screenshot shows the 'Module diagnostics' test results. At the top, it displays '3.4 %O<sub>2</sub>' and '23.0 °C'. Below this is a 'Module diagnostics' header. There are three test items: 'Communication' (ok), 'Flash check sum' (ok), and 'Meas. processing' (ok). At the bottom, there is a 'Return' button.</p>	<p><b>Module Diagnostics</b></p> <p>Function test of internal components:</p> <ul style="list-style-type: none"> <li>- Internal device communication</li> <li>- Check of firmware (module)</li> <li>- Factory settings, measured value processing</li> </ul> <p>For diagnostic functions for ISM sensors, see. p. 13</p>
	 <p>The screenshot shows the 'Sensor monitor' display. At the top, it displays '3.4 %O<sub>2</sub>' and '23.0 °C'. Below this is a 'Sensor monitor' header. There are six sensor readings: 'Sensor current' (-40.03 nA), 'Sensor current (25°C)' (-40.03 nA), 'Air pressure' (1014 mbar), 'Ext. pressure transmitter' (0 bars), 'RTD' (22.1 kΩ), and 'Temperature' (+025.0 °C). At the bottom, there is a 'Return' button.</p>	<p><b>Sensor Monitor</b></p> <p>Shows the current directly measured by the sensor, the barometric pressure, and temperature. Important function for diagnostics and validation!</p>

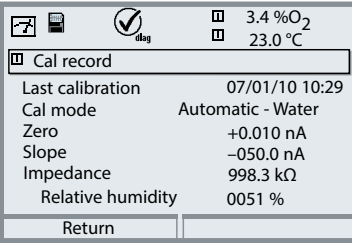
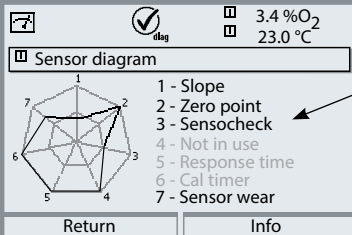
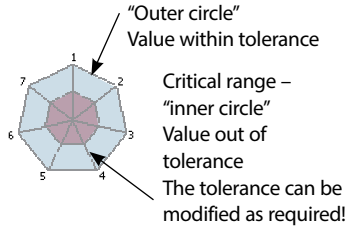
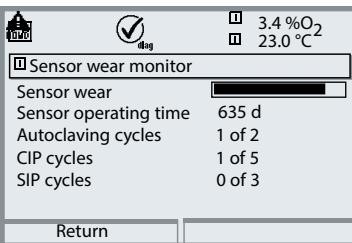

Note: The display may vary depending on the device version.

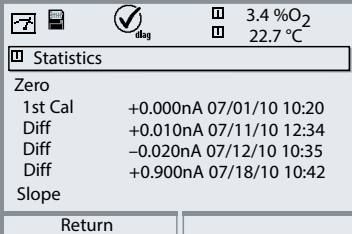
Menu	Display	Action
	 <p>Cal record</p> <p>Last calibration 07/01/10 10:29            Cal mode Automatic - Water            Zero +0.010 nA            Slope -050.0 nA            Impedance 998.3 kΩ            Relative humidity 0051 %</p> <p>Return</p>	<p><b>Calibration/Adjustment Record</b>            Data of last calibration/adjustment (Date, time, calibration method, sensor zero and slope, rel. humidity for calibration in air)</p> <p><b>Temp. Offset Log</b>            Shows the data from the last temperature adjustment performed on the currently connected sensor.<sup>1)</sup></p>
	 <p>Sensor diagram</p> <p>1 - Slope            2 - Zero point            3 - Sensoscheck            4 - Not in use            5 - Response time            6 - Cal timer            7 - Sensor wear</p> <p>Return Info</p>  <p>"Outer circle" Value within tolerance</p> <p>Critical range – "inner circle" Value out of tolerance</p> <p>The tolerance can be modified as required!</p>  <p>Sensor wear monitor</p> <p>Sensor wear </p> <p>Sensor operating time 635 d            Autoclaving cycles 1 of 2            CIP cycles 1 of 5            SIP cycles 0 of 3</p> <p>Return</p>	<p><b>Sensor Diagram</b>            The measured values are continuously monitored during the measurement process. The sensor network diagram provides at-a-glance information about critical parameters.            If a tolerance limit has been exceeded, the respective parameter is flashing. Values in gray: Monitoring switched off.</p> <p><b>Sensor Wear Monitor (ISM)</b>            In addition to the current sensor wear, the sensor operating time as well as the number of executed autoclaving, CIP, or SIP cycles can be seen at a glance.            * Menu is only displayed for ISM modules when a valid ISM sensor is connected.</p>
	 <p>Statistics</p> <p>Zero</p> <p>1st Cal +0.000nA 07/01/10 10:20            Diff +0.010nA 07/11/10 12:34            Diff -0.020nA 07/12/10 10:35            Diff +0.900nA 07/18/10 10:42            Slope</p> <p>Return</p>	<p><b>Statistics</b>            Indication of sensor data for the First Calibration and the last 3 calibrations.            (Date and time of first calibration, sensor zero point and slope, temperature, pressure and response time)</p>

1) With Protos II 4400(X)

# Setting Diagnostic Messages as Favorite

Menu selection: Parameter setting > System control > Function control matrix

## Secondary displays (1)

Here, additional values are displayed in the measuring mode according to the factory setting. When the respective softkey (2) is pressed, the process variables measured by the modules plus date or time are displayed. In addition, you can use the **softkeys (2)** to control functions.

To assign a function to a softkey, select

## Parameter setting > System control > Function control matrix

Function which can be controlled by softkeys:

- Parameter set selection
- KI recorder Start/Stop<sup>1)</sup>
- Favorites
- Unical (fully automated probe controller)<sup>1)</sup>

## Favorites

Selected Diagnostics functions can be called directly from the measuring mode using a softkey.

The table on the next page explains how to select favorites.

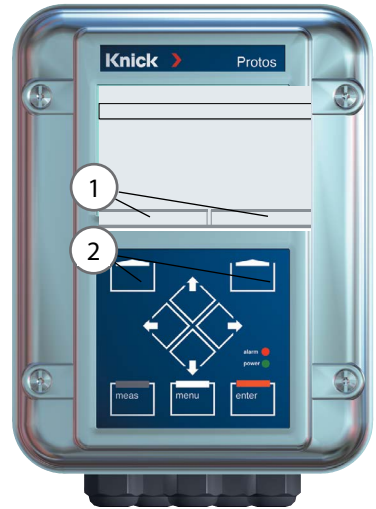

			98.1%Air	
			25.6 °C	
Function control matrix (Administrator)				
	ParSet	KI rec.	Fav	Unical
Input OK2	<input type="radio"/>	<input type="radio"/>	<input type="radio"/>	<input type="radio"/>
<b>Left softkey</b>	<input type="radio"/>	<input type="radio"/>	<input type="radio"/>	<input type="radio"/>
Right softkey	<input type="radio"/>	<input type="radio"/>	<input checked="" type="radio"/>	<input type="radio"/>
Profibus DO 2	<input type="radio"/>	<input type="radio"/>	<input type="radio"/>	<input type="radio"/>
Return		Connect		



Example:  
"Favorites" to be selected with  
"Right softkey"

To select a softkey function:  
Select desired function using arrow  
keys,  
press "Connect" softkey and  
confirm with **enter**.

To deselect a function:  
Press "Disconnect" softkey,  
confirm with **enter**.

1) With Protos 3400(X)

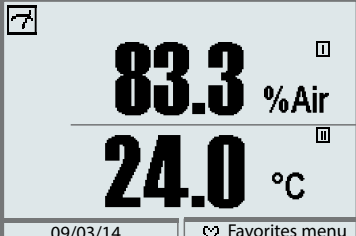
Note: The display may vary depending on the device version.

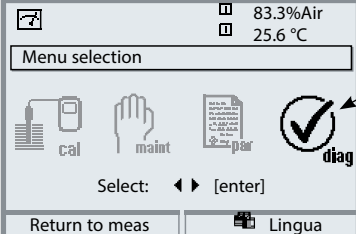
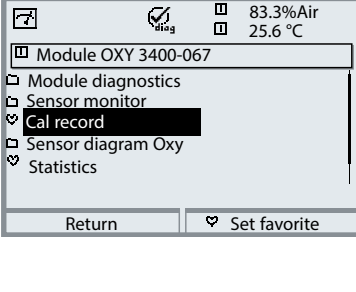
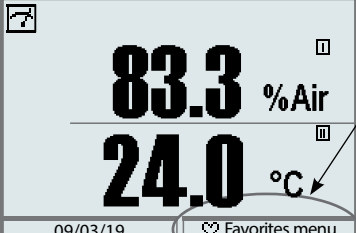
Menu	Display	Action
		<p><b>Favorites menu</b></p> <p>Diagnostics functions can be called directly from the measuring mode using a softkey. The “Favorites” are selected in the Diagnostics menu.</p>
		<p><b>Select favorites</b></p> <p>Press <b>menu</b> key to select menu. Select diagnostics using arrow keys, confirm with <b>enter</b>. Then select module and confirm with <b>enter</b>.</p>
		<p>Set/delete favorite:</p> <p>“Set favorite” allows activation of the selected diagnostic function directly from the measuring mode via softkey. The menu line is marked with a heart icon.</p>
		<p>Pressing the <b>meas</b> key returns to measurement. When the softkey has been assigned to “Favorites”, “Favorites menu” is read in the secondary display (see “Function control matrix”).</p>

**Note:**



When one of the softkeys has been assigned to the “Favorites menu” function, diagnostic functions which have been set as “Favorite” can be directly called from the measuring mode.

# Diagnostic Functions

General status information of the measuring system

Menu selection: Diagnostics > Message list

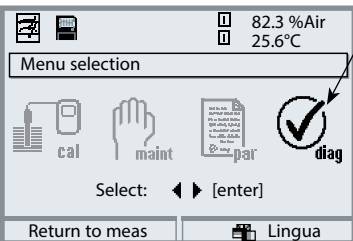
Note: The display may vary depending on the device version.

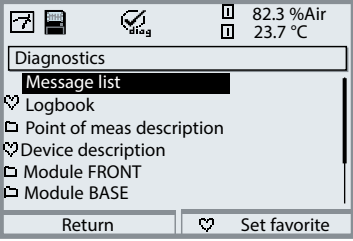
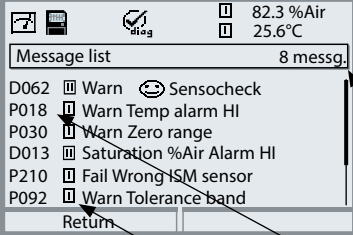
Menu	Display	Action
		<p><b>Opening the diagnostics menu</b></p> <p>From the measuring mode: Press <b>menu</b> key to select menu. Select diagnostics using arrow keys, confirm by pressing <b>enter</b>.</p>
		<p>The “Diagnostics” menu gives an overview of all functions available. Functions which have been set as “Favorite” can be directly accessed from the measuring mode.</p>
		<p><b>Message list</b></p> <p>Shows the currently activated warning or failure messages in plain text.</p> <p><b>Number of messages</b></p> <p>When there are more than 7 messages, a vertical scrollbar appears. Scroll with the up/down arrow keys.</p> <p><b>Message identifier</b></p> <p>See message list for description.</p> <p><b>Module identifier</b></p> <p>Specifies the module that has generated the message.</p>

# Messages

---

## Messages for OXY 3400(X)-067 Module with Protos 3400(X)

No.	OXY messages	Message type
D008	Meas. processing (factory settings)	FAIL
D009	Module failure (Firmware Flash check sum)	FAIL
D010	Saturation %Air Range	FAIL
D011	Saturation %Air Alarm LO_LO	FAIL
D012	Saturation %Air Alarm LO	WARN
D013	Saturation %Air Alarm HI	WARN
D014	Saturation %Air Alarm HI_HI	FAIL
D015	Temperature range	FAIL
D016	Temperature Alarm LO_LO	FAIL
D017	Temperature Alarm LO	WARN
D018	Temperature Alarm HI	WARN
D019	Temperature Alarm HI_HI	FAIL
D020	Concentration range	FAIL
D021	Concentration Alarm LO_LO	FAIL
D022	Concentration Alarm LO	WARN
D023	Concentration Alarm HI	WARN
D024	Concentration Alarm HI_HI	FAIL
D025	Part. press. range	FAIL
D026	Part. press. Alarm LO_LO	FAIL
D027	Part. press. Alarm LO	WARN
D028	Part. press. Alarm HI	WARN
D029	Part. press. Alarm HI_HI	FAIL
D030	Zero range	WARN
D035	Slope range	WARN
D040	Air pressure range	WARN

# Messages

---

<b>No.</b>	<b>OXY messages</b>	<b>Message type</b>
D041	Air pressure Alarm LO_LO	FAIL
D042	Air pressure Alarm LO	WARN
D043	Air pressure Alarm HI	WARN
D044	Air pressure Alarm HI_HI	FAIL
D045	Saturation %O2 Range	FAIL
D046	Saturation %O2 Alarm LO_LO	FAIL
D047	Saturation %O2 Alarm LO	WARN
D048	Saturation %O2 Alarm HI	WARN
D049	Saturation %O2 Alarm HI_HI	FAIL
D050	Air pressure Manual range	WARN
D060	SAD SENSOFACE: Slope	WARN
D061	SAD SENSOFACE: Zero	WARN
D062	SAD SENSOFACE: Sensocheck	User-defined
D063	SAD SENSOFACE: Response time	WARN
D064	SAD SENSOFACE: Calibration timer	WARN
D070	SAD SENSOFACE: Sensor wear	User-defined
D080	Range (sensor current)	WARN
D090	Vol% range (measurement in gases)	WARN
D091	Vol% Alarm LO_LO (measurement in gases)	FAIL
D092	Vol% Alarm LO (measurement in gases)	WARN
D093	Vol% Alarm HI (measurement in gases)	WARN
D094	Vol% Alarm HI_HI (measurement in gases)	FAIL
D095	ppm range (measurement in gases)	FAIL
D096	ppm Alarm LO_LO (measurement in gases)	FAIL
D097	ppm Alarm LO (measurement in gases)	WARN
D098	ppm Alarm HI (measurement in gases)	WARN
D099	ppm Alarm HI_HI (measurement in gases)	FAIL
D110	CIP counter	User-defined
D111	SIP counter	User-defined
D112	Autoclaving counter	User-defined

# Messages

---

No.	OXY messages	Message type
D113	Sensor operating time (duration of use)	User-defined
D114	Membrane body changes	User-defined
D115	Inner body changes	User-defined
D120	Wrong ISM sensor	FAIL
D121	ISM sensor (error in factory settings/characteristics)	FAIL
D122	ISM sensor memory (error in cal data records)	WARN
D123	New sensor, adjustment required	WARN
D130	SIP cycle counted	Text
D131	CIP cycle counted	Text
D200	Temp O2 conc/SAT	WARN
D201	Cal temp	Text
D203	Cal: Identical media	Text
D204	Cal: Media interchanged	Text
D205	Cal: Sensor unstable	Text
D254	Module reset	Text

No.	Calculation Block OXY/OXY Messages	Message type
H010	%AIR-Diff Range	FAIL
H011	%AIR-Diff Alarm LO_LO	FAIL
H012	%AIR-Diff Alarm LO	WARN
H013	%AIR-Diff Alarm HI	WARN
H014	%AIR-Diff Alarm HI_HI	FAIL
H015	Temperature-Diff Range	FAIL
H016	Temperature-Diff Alarm LO_LO	FAIL
H017	Temperature-Diff Alarm LO	WARN
H018	Temperature-Diff Alarm HI	WARN
H019	Temperature-Diff Alarm HI_HI	FAIL
H020	Concentration-Diff Range	FAIL
H021	Concentration-Diff Alarm LO_LO	FAIL

# Messages

---

No.	Calculation Block OXY/OXY Messages	Message type
H022	Concentration-Diff Alarm LO	WARN
H023	Concentration-Diff Alarm HI	WARN
H024	Concentration-Diff Alarm HI_HI	FAIL
H045	%O2-Diff Range	FAIL
H046	%O2-Diff Alarm LO_LO	FAIL
H047	%O2-Diff Alarm LO	WARN
H048	%O2-Diff Alarm HI	WARN
H049	%O2-Diff Alarm HI_HI	FAIL
H090	Vol%-Diff range (measurement in gases)	WARN
H091	Vol%-Diff Alarm LO_LO (measurement in gases)	FAIL
H092	Vol%-Diff Alarm LO (measurement in gases)	WARN
H093	Vol%-Diff Alarm HI (measurement in gases)	WARN
H094	Vol%-Diff Alarm HI_HI (measurement in gases)	FAIL
H095	ppm-Diff range (measurement in gases)	FAIL
H096	ppm-Diff Alarm LO_LO (measurement in gases)	FAIL
H097	ppm-Diff Alarm LO (measurement in gases)	WARN
H098	ppm-Diff Alarm HI (measurement in gases)	WARN
H099	ppm-Diff Alarm HI_HI (measurement in gases)	FAIL



# Messages

## Messages for OXY 3400(X)-067 Module with Protos II 4400(X)

 Failure
  Out of Specification
  Maintenance Required

No.	Message Type	OXY Messages
D008	Failure	Meas. Processing (Factory Settings)
D009	Failure	Firmware Error
D010	Failure	Saturation %air range
D011	Failure	Saturation %Air Alarm LO_LO
D012	Out of Specification	Saturation %Air Alarm LO
D013	Out of Specification	Saturation %Air Alarm HI
D014	Failure	Saturation %Air Alarm HI_HI
D015	Failure	Temperature Range
D016	Failure	Temperature Alarm LO_LO
D017	Out of Specification	Temperature Alarm LO
D018	Out of Specification	Temperature Alarm HI
D019	Failure	Temperature Alarm HI_HI
D020	Failure	Concentration Range
D021	Failure	Concentration Alarm LO_LO
D022	Out of Specification	Concentration Alarm LO
D023	Out of Specification	Concentration Alarm HI
D024	Failure	Concentration Alarm LO_LO
D025	Failure	Partial Pressure Range
D026	Failure	Partial Pressure Alarm LO_LO
D027	Out of Specification	Partial Pressure Alarm LO
D028	Out of Specification	Partial Pressure Alarm HI
D029	Failure	Partial Pressure Alarm HI_HI
D040	Failure	Air Pressure Range
D041	Failure	Air Pressure Alarm LO_LO
D042	Out of Specification	Air Pressure Alarm LO
D043	Out of Specification	Air Pressure Alarm HI
D044	Failure	Air Pressure Alarm HI_HI
D045	Failure	Saturation %O2 Range
D046	Failure	Saturation %O2 Alarm LO_LO
D047	Out of Specification	Saturation %O2 Alarm LO
D048	Out of Specification	Saturation %O2 Alarm HI
D049	Failure	Saturation %O2 Alarm HI_HI

# Messages

---

<b>No.</b>	<b>Message Type</b>	<b>OXY Messages</b>
D060	Failure/ Maintenance Required	Sad Sensoface: Slope
D061	Failure/ Maintenance Required	Sad Sensoface: Zero Point
D062	User-defined	Sad Sensoface: Sensocheck
D063	Maintenance Required	Sad Sensoface: Response Time
D064	Maintenance Required	Sad Sensoface: Calibration timer
D070	User-defined	Sad Sensoface: Sensor Wear
D080	Maintenance Required	Sensor Current Range
D110	User-defined	CIP Counter
D111	User-defined	SIP Counter
D112	User-defined	Autoclaving Counter
D113	User-defined	Sensor Operating Time
D114	User-defined	Membrane Body Changes
D115	User-defined	Interior Body Replacement
D120	Failure	Wrong Sensor (Sensor Verification)
D121	Failure	Sensor Error (Factory/Characteristic Data)
D122	Maintenance Required	Sensor Memory Error (Cal Data)
D123	Maintenance Required	New Sensor, Adjustment Required
D124	Maintenance Required	Sensor Date
D130	Info	SIP Cycle Counted
D131	Info	CIP Cycle Counted
D200	Maintenance Required	Temp O2 Conc/Sat
D201	Maintenance Required	Cal Temperature
D203	Info	Cal: Identical Media
D204	Info	Cal: Cal: Media Interchanged
D205	Info	Cal: Sensor Unstable
D254	Info	Module Reset

# Messages

---

<b>No.</b>	<b>Message Type</b>	<b>Calculation Block OXY / OXY Messages</b>
H010	Failure	Saturation %AIR Diff Range
H011	Failure	Saturation %AIR Diff Alarm LO_LO
H012	Out of Specification	Saturation %AIR Diff Alarm LO
H013	Out of Specification	Saturation %AIR Diff Alarm HI
H014	Failure	Saturation %AIR Diff Alarm HI_HI
H015	Failure	Temperature Diff Range
H016	Failure	Temperature Diff Alarm LO_LO
H017	Out of Specification	Temperature Diff Alarm LO
H018	Out of Specification	Temperature Diff Alarm HI
H019	Failure	Temperature Diff Alarm HI_HI
H020	Failure	Concentration (Liquid) Diff Range
H021	Failure	Concentration (Liquid) Alarm LO_LO
H022	Out of Specification	Concentration (Liquid) Diff Alarm LO
H023	Out of Specification	Concentration (Liquid) Diff Alarm HI_HI
H024	Failure	Concentration (Liquid) Diff Alarm HI_HI
H045	Failure	%O2 Diff Range
H046	Failure	%O2 Diff Alarm LO_LO
H047	Out of Specification	%O2 Diff Alarm LO
H048	Out of Specification	%O2 Diff Alarm HI
H049	Failure	%O2 Diff Alarm HI_HI
H090	Failure	Vol% Diff Range (Measurement in Gases)
H091	Failure	Vol% Diff Alarm LO_LO (Measurement in Gases)
H092	Out of Specification	Vol% Diff Alarm LO (Measurement in Gases)
H093	Out of Specification	Vol% Diff Alarm HI (Measurement in Gases)
H094	Failure	Vol% Diff Alarm HI_HI (Measurement in Gases)
H200	Maintenance Required	Calculation Block Configuration

---

# Specifications

## Protos OXY 3400(X)-067 Specifications

<b>Input for sensors</b>	SE 7*6 ... , SE 7*7 ... or "other"			
Automatic range selection:				
<b>Input range 1</b>	Meas. current 0 ... 600 nA, resolution 10 pA			
Meas. error <sup>2)</sup>	< 0.5 % meas. val. + 0.05 nA + 0.005 nA/K			
<b>Input range 2</b>	Meas. current 0 ... 10000 nA, resolution 166 pA			
Meas. error <sup>2)</sup>	< 0.5 % meas. val. + 0.8 nA + 0.08 nA/K			
<b>Display ranges</b>	<b>Standard sensor</b> (SE 7*6 ...)	<b>Trace sensor</b> <b>01</b> (SE 7*7 ...)	<b>Trace sensor</b> <b>001</b> <sup>3)</sup>	<b>Other</b>
Saturation (-10 ... 80 °C)		0.000 ... 9.999 %Air	0.000 ... 9.999 %Air	0.000 ... 9.999 %Air
		00.00 ... 99.99 %Air	00.00 ... 99.99 %Air	00.00 ... 99.99 %Air
		000.0 ... 999.9 %Air	000.0 ... 999.9 %Air	000.0 ... 999.9 %Air
		0.000 ... 9.999 %O2	0.000 ... 9.999 %O2	0.000 ... 9.999 %O2
Concentration (-10 ... 80 °C) (dissolved oxygen)		00.00 ... 99.99 %O2	00.00 ... 99.99 %O2	00.00 ... 99.99 %O2
		000.0 ... 999.9 %O2	000.0 ... 999.9 %O2	000.0 ... 999.9 %O2
			000.0 ... 9.999 µg/l	0000 ... 9999 µg/l
		0000 ... 9999 µg/l	0000 ... 9999 µg/l	0000 ... 9999 µg/l
Volume concentration in gas		00.00 ... 99.99 mg/l	00.00 ... 99.99 mg/l	00.00 ... 99.99 mg/l
		000.0 ... 999.9 mg/l	000.0 ... 999.9 mg/l	000.0 ... 999.9 mg/l
			0000 ... 9999 ppb	0000 ... 9999 ppb
		0000 ... 9999 ppm	0000 ... 99.99 ppm	0000 ... 99.99 ppm
Partial pressure		000.0 ... 999.9 ppm	000.0 ... 999.9 ppm	000.0 ... 999.9 ppm
			0000 ... 9999 ppm	0000 ... 9999 ppm
		0.000 ... 9.999 Vol%	0.000 ... 9.999 Vol%	0.000 ... 9.999 Vol%
		00.00 ... 99.99 Vol%	00.00 ... 99.99 Vol%	00.00 ... 99.99 Vol%
Permissible guard current			0.000 ... 9.999 mbar	0.000 ... 9.999 mbar
		00.00 ... 00.00 mbar	00.00 ... 00.00 mbar	00.00 ... 00.00 mbar
		000.0 ... 000.0 mbar	000.0 ... 000.0 mbar	000.0 ... 000.0 mbar
		0000 ... 9999 mbar	0000 ... 9999 mbar	0000 ... 9999 mbar
Polarization voltage			0.000 ... 9.999 mmHg	0.000 ... 9.999 mmHg
		00.00 ... 00.00 mmHg	00.00 ... 00.00 mmHg	00.00 ... 00.00 mmHg
		000.0 ... 000.0 mmHg	000.0 ... 000.0 mmHg	000.0 ... 000.0 mmHg
		0000 ... 9999 mmHg	0000 ... 9999 mmHg	0000 ... 9999 mmHg
Permissible guard current	≤ 20 µA			
Polarization voltage	0 ... -1,000 mV, default -675 mV (resolution < 5 mV)			
<b>Pressure correction</b>				
Air pressure	700 ... 1100 mbar			
Manual	0 ... 9999 mbar			
External	0 ... 9999 mbar (through current input 0(4) ... 20 mA input)			
Via bus	0 ... 9999 mbar (via PROFIBUS or Foundation Fieldbus)			
<b>Salinity correction</b>	0.0 ... 45.0 g/kg			

# Specifications

---

<b>ISM</b>	Intelligent Sensor Management Display of sensor data: Manufacturer, serial number, a.o.
<b>Sensor monitoring <sup>1)</sup></b>	Sensocheck Monitoring of membrane and electrolyte
<b>Sensoface Sensor diagram</b>	provides information on the sensor condition: Zero, slope, response time, calibration interval, Sensocheck, wear (ISM)
<b>Sensor monitor</b>	Direct display of measured values from sensor for validation: Sensor current / barometric pressure / temperature / I input
<b>Wear monitor</b>	Display of wear parameters Sensor wear / sensor operating time / autoclaving cycles / SIP cycles / CIP cycles
<b>Sensor standardization <sup>1)</sup></b>	Operating modes - Automatic calibration in air-saturated water - Automatic calibration in air - Product calibration: Saturation - Product calibration: Concentration - Data entry zero/slope - Zero correction
<b>Calibration record/ statistics</b>	Recording of: Zero, slope, response time, calibration method with date and time of the last three calibrations and the first calibration
<b>Temperature input</b>	
Temperature probe <sup>1)</sup>	NTC 22 kΩ / NTC 30 kΩ, 2-wire connection, adjustable
Measuring range	-20 ... 150 °C / -4 ... 302 °F
Resolution	0.1 °C
Meas. error <sup>2)</sup>	0.2 % meas.val. + 0.5 K (< 1 K with T > 100 °C / 212 °F)
<b>Input</b>	0(4) ... 20 mA for absolute or differential pressure transmitter
Pressure range	0 ... 9999 mbar
Current range	0(4) ... 20 mA / 50 Ω Start/end user-defined within pressure range
Resolution	< 1%

1) User-defined

2) Rated operating conditions, ± 1 count, plus sensor error

3) With Protos 3400(X)

# Specifications

---

## General Data

<b>Explosion protection</b> (Ex version of module only)	For entity parameters, see attachment to certificates or control drawings.
<b>RoHS conformity</b>	According to EU directive 2011/65/EU
<b>EMC</b>	EN 61326-1, EN 61326-2-3 NAMUR NE 21
Emitted interference	Industrial applications <sup>1)</sup>
Interference immunity	(EN 55011 Group 1 Class A) Industrial applications
Lightning protection	to EN 61000-4-5, Installation class 2
<b>Rated operating conditions</b> (module installed)	
Ambient temperature	Safe area: -20 ... 55 °C / -4 ... 131 °F Ex: -20 ... 50 °C / -4 ... 122 °F
Relative humidity	5 ... 95 %
Climatic class	3K5 according to EN 60721-3-3
Location class	C1 according to EN 60654-1
<b>Transport/storage temperature</b>	-20 ... 70 °C / -4 ... 158 °F
<b>Screw clamp connectors</b>	Single or stranded wires 0.2 ... 2.5 mm <sup>2</sup> Tightening torque 0.5 ... 0.6 Nm
Wiring	Stripping length max. 7 mm Temperature resistance > 75 °C / 167 °F

1) This equipment is not designed for domestic use, and is unable to guarantee adequate protection of the radio reception in such environments.

# Appendix:

---

## Minimum Spans for Current Outputs

The OXY 3400(X)-067 module is a measuring module. It does not provide current outputs. Current outputs are provided by the BASE module (basic device) or by communication modules (e.g. OUT, PID). The corresponding parameters must be set there.

The minimum current span shall prevent that the resolution limit of the measurement technology ( $\pm 1$  count) is seen in the current.

### OXY 3400(X)-067 Module

%Air	0.1
%O <sub>2</sub>	0.1
°C	10.0
mbar	20.0 (barometric pressure)
nA	10 % min. 1.00 nA
mg/l	2 µg/l
ppm	2 ppb
mbar	1 mbar (partial pressure)
Vol%	0.01
ppm	100
°F	10.0

### Calculation Block OXY/OXY

Diff %Air	0.1
Diff-%O <sub>2</sub>	0.1
Diff mg/l	10 % min. 2.0 µg/l
Diff ppm	10 % min. 2.0 ppb
Diff °C	10.0
Diff Vol%	0.01
Diff ppm	100



# Dissolved Oxygen Measurement in Carbonated Beverages (Only with Protos 3400(X): SW3400-011)

---

Application-specific add-on function for breweries

## **Recommended only for SE 7\*7 ... series sensors!**

This add-on function simplifies parameter setting since all steps not required for dissolved oxygen measurement in carbonated beverages are omitted. It simultaneously acts on all installed OXY modules (module firmware version 2.2 and higher).

### **Function principle:**

The following processes are automated by the additional function, i.e. all parameters required for the respective program step are set automatically.

During the filling process, for example, it must be ensured that as little oxygen as possible is dissolved in the beer to extent its shelf life.

During oxygen trace measurement the sensor is operated with a very low polarization voltage (-500 mV). This results in low cross-sensitivity to CO<sub>2</sub>.

For a calibration in air, this polarization voltage is too low.

It must be set to -675 mV and afterwards be reduced again to -500 mV for measuring in the trace range.

Be sure to wait long enough for the sensor to stabilize.

Opening and closing of valves causes pressure variations in the beer pipes which momentarily falsify the O<sub>2</sub> signal. Therefore the input signal must be attenuated correspondingly to suppress transient interferences.

# Overview

## Overview of Parameter Setting

### Parameter Setting Menu

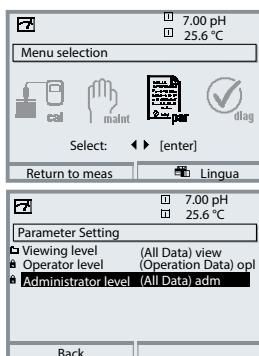

#### Parameter Setting

From measuring mode: Press **menu** key to select menu. Select parameter setting using arrow keys, press **enter** to confirm.

##### Administrator level

Access to all functions, also passcode setting. Releasing or blocking functions for access from the Operator level.

##### Operator level

Access to all functions which have been released at the Administrator level. Blocked functions are displayed in gray and cannot be edited.

##### Viewing level

Only display, no editing possible!

#### System Control

Memory card (Option)	Menu only appears when a memory card is inserted and the corresponding add-on function has been enabled.
Transfer configuration	The complete configuration of a device can be written on a memory card. This allows transferring all device settings to other devices with identical equipment (exception: options and passcodes).
Parameter set	2 parameter sets (A, B) are available in the device. The currently active parameter set is shown in the display. Parameter sets contain all settings except: sensor type, options, system control settings Up to 5 parameter sets (1, 2, 3, 4, 5) are available when a memory card (Option) is used.
Function control	Select the functions to be controlled via softkeys and OK inputs
Time/date	Time, date, display format
Meas. point description	Free input of a tag number, can be called from the diagnostics menu
Release of options	Option activation via TAN
Reset to default	Reset all parameters to factory setting
Passcode entry	Change passcodes
Firmware update	Update the firmware using an Update Card
Logbook	Select the events to be recorded

Note: The menus may vary depending on the device version

# Overview

## Overview of Parameter Setting

### Parameter Setting Menu



#### FRONT Module: Display Settings

Language	Select the menu language
Units <sup>1)</sup>	Select the measurement units
Formats <sup>1)</sup>	Select the display format
Measurement display	Representation of measured values on the display
Display	Brightness/contrast, auto-off

#### BASE Module: Signal Outputs and Inputs, Contacts

Output current I1, I2	Separately adjustable current outputs
Contact K4	Failure signaling
Contacts K3, K2, K1	Separately adjustable relay contacts
Inputs OK1, OK2	Optocoupler signal inputs

**Note:** The menu may vary depending on the device version

1) With Protos II 4400(X) only

# Parameter Setting Menu



## OXY 3400-067 Module

<b>Operating Mode</b> <sup>1)</sup>	Analog or ISM
<b>Input filter</b>	Noise suppression
<b>Sensor data</b>	Representation of measured values on the display: Liquids, Gases
• Measure in	Standard sensor, Trace sensor 01, Trace sensor 001 <sup>2)</sup> , Other
• Sensor type	Monitor, Off (for ISM sensor only)
• Monitor sensor type	NTC 22 kohms, NTC 30 kohms
• Temperature probe	01.00
• Membrane correction	
• Sensor polarization	675 mV or entry
• Polarization voltage	
• Sensoface	
• Sensor monitoring details	Slope, zero, Sensocheck, response time, temperature, sensor wear <sup>2)</sup> , <sup>3)</sup> , TTM- maintenance timer <sup>3)</sup> , DLI Lifetime Indicator <sup>3)</sup> , CIP /SIP counter <sup>3)</sup> , autoclaving counter <sup>3)</sup> , sensor operating time <sup>3)</sup> , membrane body changes <sup>3)</sup> , inner body changes <sup>4)</sup>
<b>Cal preset values</b>	
• Cal saturation	
• Cal concentration	mg/l, µg/l, ppm, ppb
• Calibration timer	
<b>Pressure correction</b>	
• Ext. pressure transmitter	
• Pressure during meas	
• Pressure during cal	
<b>Salinity correction</b>	
• Input	
• Salinity	Salinity, Chlorinity, Conductivity
<b>Messages</b>	
• Saturation %Air	
• Saturation %O <sub>2</sub>	
• Concentration	
• Partial pressure	
• Air pressure	

# Calibration Menu



## OXY 3400-067 Module

Automatic - Water	
Automatic - Air	
Product calibration Sat	
Product calibration Conc	
Data entry	
Zero correction	
Temp probe adjustment <sup>1)</sup>	Compensating for lead length

# Maintenance Menu



## BASE Module

Current source                      Output current definable 0 ... 22 mA

## OXY 3400(X)-067 Module

Sensor monitor	Sensor current, air pressure, ext. pressure transmitter, RTD, temperature, impedance, current input
Temp probe adjustment	Compensating for lead length (with Protos 3400(X))
Autoclaving counter	Shows the number of executed autoclaving cycles as well as the maximally permitted number of cycles
Membrane body changes	Shows the number of executed membrane body changes as well as the maximally permitted number of changes
Inner body changes	Shows the number of executed inner body changes as well as the maximally permitted number of changes

# Diagnostics Menu



Message list	List of all messages
Point of meas description	Shows the tag number and annotation
Logbook	Shows the last events with date and time
Device description	Hardware version, Serial no., (Module) Firmware, Options

## FRONT Module

Module diagnostics  
Display test  
Keypad test

## BASE Module

Module diagnostics  
Input/output status

## OXY 3400-067(X) Module

Module diagnostics	Sensor monitor, sensor diagram, cal/adj record, temp. offset
Sensor diagnostics	log <sup>1)</sup> , sensor wear monitor <sup>3)</sup> , load diagram <sup>2)</sup> , <sup>3)</sup> , statistics

1) with Protos II 4400(X)    2) with Protos 3400(X)    3) for ISM only

Note: The menus may vary depending on the device version

# Index

---

## A

- Adjusting the temperature probe (Protos 3400) 53
- Adjusting the temperature probe (Protos II 4400) 32
- Adjustment 20
- Administrator level 34
- Application in hazardous locations 6
- Attaching the terminal plates 16
- Autoclaving counter (ISM only) 12
- Automatic calibration in air 26
- Automatic calibration in water 24

## B

- BASE module, parameter setting 48
- Behavior during messages 51
- Bilinear characteristic 49

## C

- Calculation Blocks 43
- Calibration 19
- Calibration/adjustment record 57
- Calibration, automatic in air 26
- Calibration, automatic in water 24
- Calibration by data entry 30
- Calibration, recommendations 21
- Calibration with sampling 28
- Calibration, zero correction 31
- Call up parameter setting 36
- Cal record 57
- CIP (Cleaning in Place) 15
- Configuration, "par" menu 36
- Connecting the module 17
- Contacts, parameter setting 51
- Corrective maintenance 6
- Current outputs 48

# Index

---

Current outputs, characteristics 49  
Current outputs, minimum spans 72

## D

Data entry of premeasured sensors 30  
Device description, Diagnostics menu 55  
Device firmware 7  
Device limits max. 47  
Diagnostic functions 54  
Diagnostic messages 61  
Diagnostic messages as favorite 58  
Disposal 2  
Dissolved oxygen measurement in carbonated beverages (SW3400-011) 73

## E

Electrostatic discharge (ESD) 17  
EMC 71  
Error messages 61  
ESD shield 17  
Explosion protection, safety instructions 6  
External current input, wiring 18

## F

Factory setting 45  
Favorites 58  
Firmware version 7  
First adjustment 19  
Function control matrix 58

## H

Hardware and firmware version 7  
HOLD mode during calibration 22

# Index

---

## I

- Inner body changes (ISM only) 12
- Installing the module 17
- Intended use 5
- ISM diagnostics 13
- ISM first adjustment 10
- ISM - Intelligent Sensor Management 8
- ISM parameter setting 11
- ISM plug and measure 9
- ISM predictive maintenance 12
- ISM, wiring 18

## L

- Linear characteristic 49
- Load diagram, diagnostics 14
- Lock icon 35
- Locking a function 35
- Logarithmic output curve 50
- Logbook (Diagnostics menu) 54
- Logbook (parameter setting) 45

## M

- Maintenance menu 53
- Measuring point description 54
- Membrane body changes (ISM only) 12
- Message icons 47
- Message list 60
- Messages 47, 60
- Messages with Protos 3400(X) 61
- Messages with Protos II 4400(X) 65
- Minimum spans for current outputs 72
- Module compatibility 7
- Module diagnostics 56
- Module firmware 7
- Module installation 17



# Index

---

## O

- Operating levels 34
- Operator level 34
- Optocoupler inputs 51
- Output filter 51
- Overview of parameter setting 74

## P

- Parameter setting 33, 36
- Parameter setting, overview 74
- Point of meas description 54

## R

- Rated operating conditions 71
- Release (softkey function) 35
- Restore factory settings 45
- Returns 2

## S

- Safety Instructions 6
- Secondary displays 58
- Sensocheck 42
- Sensoface 37
- Sensoface criteria 42
- Sensor connection 18
- Sensor data 37
- Sensor diagram 57
- Sensor monitor, Diagnostics menu 56
- Sensor monitoring details 37
- Sensor monitoring details, ISM 11
- Sensor monitor, Maintenance menu 53
- Sensor replacement –first adjustment 19
- Sensor type (standard, traces, ISM) 18
- Sensor wear monitor (ISM only) 13
- Serial number 7

# Index

---

SIP (Sterilization in Place) 15  
Slope 42  
Softkeys, function control 58  
Specifications 69  
Standard, sensor type, wiring 18  
Start (4 mA) and end (20 mA) 48  
Statistics 57  
Statistics, ISM 14

## **T**

Table of contents 3  
Technical data 69  
Temp probe adjustment (Protos 3400) 53  
Temp probe adjustment (Protos II 4400) 32  
Terminal plate 16  
Traces 01/001, sensor type, wiring 18  
Trilinear characteristic 49

## **V**

Variable limits 47  
Viewing level 34

## **W**

Wiring 18

## **Z**

Zero correction 31





**Knick**  
**Elektronische Messgeräte**  
**GmbH & Co. KG**

**Headquarters**

Beuckestraße 22 • 14163 Berlin

Germany

Phone: +49 30 80191-0

Fax: +49 30 80191-200

info@knick.de

www.knick.de

**Local Contacts**

www.knick-international.com

Copyright 2020 • Subject to change

Version: 8

This document was published on November 13, 2020.

The latest documents are available for download on our website  
below the corresponding product description.



097686

TA-201.067-KNEN08

Firmware version: 3.x