

The Art of Measuring.

Knick 

User Manual
English

Protos 3400(X) Process Analysis System

Communication Module Protos FIU 3400-141-2
For Memosens and Probe Controller

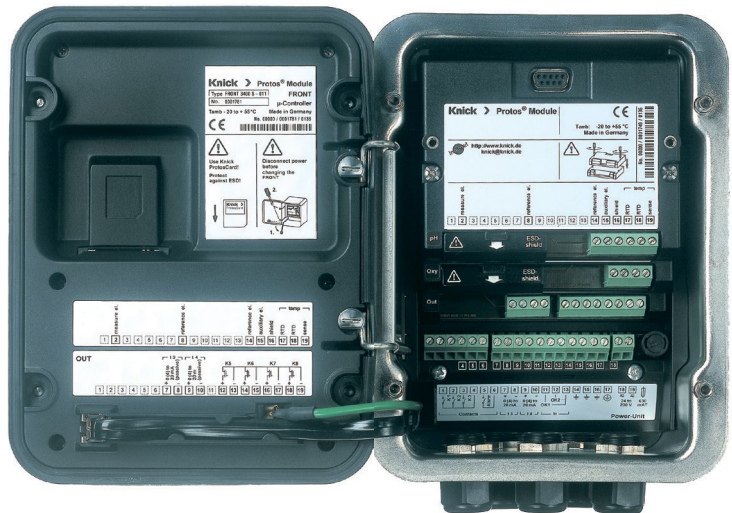

MEMO SENS

Latest Product Information: www.knick.de

Return of Products under Warranty

Please contact our Service Team before returning a defective device. Ship the cleaned device to the address you have been given. If the device has been in contact with process fluids, it must be decontaminated/disinfected before shipment. In that case, please attach a corresponding certificate, for the health and safety of our service personnel.

Disposal

Please observe the applicable local or national regulations concerning the disposal of "waste electrical and electronic equipment".

Trademarks

The following trademarks are used in this manual without further marking:

CalCheck®, Calimatic®, Protos®, Sensocheck®, Sensoface®, Unical®, VariPower®, Ceramat®, SensoGate® are registered trademarks of Knick Elektronische Messgeräte GmbH & Co. KG, Germany

Memosens®

is a registered trademark of

Endress+Hauser Conducta GmbH & Co. KG, Germany

Knick Elektronische Messgeräte GmbH & Co. KG, Germany

SMARTMEDIA®

is a registered trademark of Toshiba Corp., Japan

Knick

Elektronische Messgeräte GmbH & Co. KG

Beuckestr. 22

14163 Berlin, Germany

Phone: +49 30 801 91 - 0

Fax: +49 30 801 91 - 200

Web: www.knick.de

Email: info@knick.de

Overview of Functions

FIU 3400-141 module

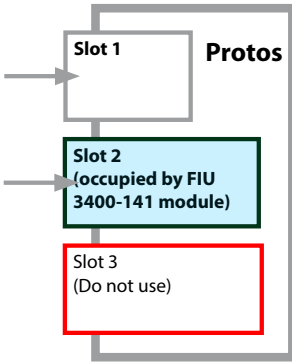

The FIU 3400-141 module has a very wide range of functions – it occupies 2 of the 3 slots in the Protos. As standard, the module can serve as probe controller with additional Memosens channel. With an optionally available additional function, you can activate a second channel for Memosens sensors. The connection of Memosens oxygen sensors is also possible by activating an optional function. The overview below shows where the individual functions are explained.

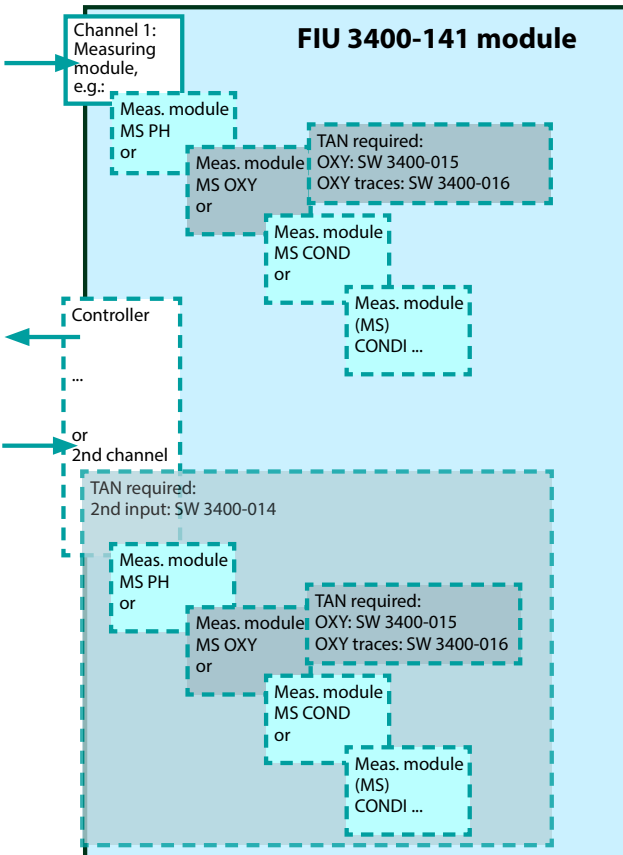

Description

Memosens PH.....	Page 43
Memosens ORP	Page 69
Memosens OXY	Page 83
Memosens COND	Page 103
CONDI (SE 670).....	Page 133
Probe control	Page 173
Activating a 2nd channel	Page 28

Table of Contents

FIU 3400-141 Module

Return of Products under Warranty	2
Disposal	2
Trademarks	2
Intended Use.....	13
Safety Information	14
Conformity with FDA 21 CFR Part 11	15
Software Version	16
Modular Concept	17
Short Description	18
Short Description: FRONT Module	18
Short Description: Menu Structure.....	19
Short Description: BASE Module	21
Terminal Plate	22
Inserting the Module	23
FIU 3400-141 Digital Module	25
Connecting Memosens Sensors	26
Memosens: 2nd Measuring Channel.....	27
Menu Selection	29
Menu Structure	29
Passcode Entry.....	30
Configuring the Measurement Display	31
Parameter Setting: Operating Levels	33
Viewing level, Operator level, Administrator level	33
Parameter Setting: Lock Functions	34
Documenting Parameter Setting	35
ProgaLog 3000 Software (Option) for Configuration and Documentation	37
Configuration using "ProgaLog 3000"	40
Module Configuration: Operating Mode.....	41
Memosens PH Parameter Setting	43
Activating the Cal Tolerance Band (Memosens PH)	46

Table of Contents

FIU 3400-141 Module

Memosens PH Calibration / Adjustment	50
Adjustment (Memosens PH)	51
Calibration Methods	52
One-point calibration	52
Two-point calibration.....	52
Three-point calibration	52
Temperature compensation.....	53
HOLD Function During Calibration	54
Calimatic Automatic Buffer Recognition	56
Calibration with Manual Entry of Buffer Values	58
Product Calibration	60
Calibration by Entering Data from Premeasured Electrodes	62
Memosens PH Maintenance	64
Sensor Monitor.....	64
Temp Probe Adjustment.....	64
Memosens PH Diagnostics	65
Message List.....	65
Logbook.....	65
Sensor Monitor.....	66
Cal Record.....	66
Sensor Network Diagram	67
Sensor Wear Monitor	67
Calibration Timer	68
Adaptive Calibration Timer.....	68
Tolerance Adjustment	68
Memosens ORP Parameter Setting.....	69
Memosens ORP Calibration / Adjustment.....	74
ORP related to the standard hydrogen electrode (SHE)	74
Temperature dependence measured against SHE	75
Memosens ORP Maintenance	76
Sensor Monitor.....	76
Temp Probe Adjustment.....	76

Table of Contents

FIU 3400-141 Module

Memosens ORP Diagnostics Functions	77
Message List.....	77
Logbook.....	77
Sensor Monitor.....	78
Cal Record.....	79
Memosens OXY (TAN required).....	81
Activating an Additional Function.....	82
Memosens OXY Parameter Setting.....	83
Memosens OXY Calibration / Adjustment.....	87
Adjustment (Memosens OXY).....	88
Recommendations for Calibration.....	89
HOLD Function During Calibration	90
Automatic Calibration in Water.....	92
Automatic Calibration in Air.....	94
Product Calibration (Calibration with Sampling)	96
Data Entry of Premeasured Sensors	98
Zero Correction.....	99
Memosens OXY Maintenance.....	100
Sensor Monitor.....	100
Temp Probe Adjustment.....	100
Sensor Maintenance	100
Memosens OXY Diagnostics	101
Sensor Monitor.....	101
Cal Record.....	102
Sensor Network Diagram OXY	102
Sensor Wear Monitor	102
Memosens COND Parameter Setting.....	103
Concentration Curves (Memosens COND).....	106
Concentration Table (Memosens COND).....	109
USP Function (Memosens COND)	110
pH Value Calculation (Memosens COND).....	111
Calculation Blocks (Memosens COND).....	113

Table of Contents

FIU 3400-141 Module

Memosens COND Calibration / Adjustment	117
Adjustment (Memosens COND).....	118
Temperature Compensation	119
HOLD Function During Calibration	120
Automatic Calibration with Standard Calibration Solution.....	122
Manual Entry of Cal Solution	124
Product Calibration	126
Data Entry of Premeasured Sensors	128
Sensor Calibration.....	129
Memosens COND Maintenance	130
Sensor Monitor.....	130
Temp Probe Adjustment.....	130
Memosens COND Diagnostics	131
Sensor Monitor.....	131
Cal Record.....	132
CONDI Parameter Setting (SE 670 Sensor)	133
Concentration Curves (CONDI)	136
Concentration Table (CONDI).....	139
CONDI Calibration / Adjustment	141
Adjustment (CONDI)	142
Temperature Compensation	143
HOLD Function During Calibration	144
Automatic Calibration with Standard Calibration Solution.....	146
Manual Entry of Cal Solution	148
Product Calibration	150
Data Entry of Premeasured Sensors.....	152
Zero Correction (CONDI).....	153
CONDI Maintenance	154
Sensor Monitor.....	154
Temp Probe Adjustment.....	154
CONDI Diagnostics	155
Sensor Monitor.....	155
Cal Record.....	156

Table of Contents

FIU 3400-141 Module

Parameter Setting, General	157
Logbook.....	157
Factory Setting.....	157
Configuring a Current Output.....	158
Current Outputs: Characteristics	159
Output Filter.....	161
NAMUR Signals: Current Outputs	162
NAMUR Signals: Relay Contacts.....	163
Relay Contacts: Protective Wiring	164
Relay contacts, usage	165
Relay Contacts: Sensoface Messages.....	166
Rinse Contact.....	167
Limit Value, Hysteresis, Contact Type.....	168
Icons in the measurement display.....	168
OK1, OK2 Inputs: Specify Level	169
Selecting Parameter Set (A, B) via OK2 Input	170
Signaling Active Parameter Set via Relay Contact.....	170
Overview of the System Components	171
Probe Control via FIU 3400-141 Module	173
Connection of Probe Controller	174
Parameter Setting: Operating Modes.....	175
"Memosens/Unical-Uniclean" Mode	176
Configuring the Unical 9000 Probe Controller	177
Cal Presetting for Unical 9000	178
Time Control.....	178
Time Control: Fixed Interval.....	179
Time Control: Week Program	179

Table of Contents

FIU 3400-141 Module

Parameter Setting: Program Flows	180
Cleaning (continuous), Media monitoring off.....	180
Cal 2point (continuous), Media monitoring off.....	181
Cal 1point (continuous), Media monitoring off.....	182
Parking	184
Measurement (short-time), Media monitoring off.....	185
Cal 2point (short-time), Media monitoring off.....	186
Cal 1point (short-time), Media monitoring off.....	187
Service.....	188
Configure Program Flow	189
Enter Program Name	189
Edit Program Step.....	189
Configure Function.....	190
Activate Monitoring	190
Parameter Setting: Installation.....	191
Select Measurement Procedure.....	192
External Control via DCS.....	192
Control via Process Control System (DCS)	193
Control Programs and Measurement Procedures.....	194
Sensor detection	195
Immersion lock.....	195
Probe.....	195
Sealing water	195
Check interval, Maintenance interval	195
Configuring Media Monitoring.....	196
Media Adapter.....	197
Additional Media (2).....	197
Start-Up.....	197

Table of Contents

FIU 3400-141 Module

System Forecast (Ceramat, SensoGate)	198
Reference / Probe Travel Profiles	199
Creation of a Probe Travel Profile and Presentation in Protos	199
Setting the System Forecast Parameters	200
System Forecast: Reference Profile	201
System Forecast: Tolerance Specifications	203
System Forecast: Diagnostic Messages	205
System Forecast: Recording on SmartMedia Card	206
Configuring the Unclean 900 Probe Controller	208
Measuring Module	209
Time Control.....	209
Time Control: Fixed Interval.....	210
Time Control: Week Program	210
Parameter Setting: Program Flows	211
Rinsing (continuous)	211
Cleaning (continuous)	212
Parking	214
Measuring (short-time)	215
Service	216
Edit Program Step	217
Configure Function.....	217
Parameter Setting: Installation.....	218
Select Measurement Procedure.....	219
External Control via DCS.....	219
Control via Process Control System (DCS)	220
Control Programs and Measurement Procedures.....	221
Sensor Detection.....	222
Immersion Lock	222
Probe.....	222
Sealing Water	222
Check Interval / Maintenance Interval	222
Media Adapter.....	223
Additional Media (2).....	223
Start-Up.....	223

Table of Contents

FIU 3400-141 Module

Maintenance of Memosens PH	224
Sensor monitor, Temp probe adjustment.....	224
Probe Maintenance via Protos 3400	225
Diagnostics Functions	229
Access Diagnostics.....	229
Point of Meas Description.....	229
Logbook.....	229
Device Description	230
FIU 3400-141 Diagnostics	231
Module Diagnostics.....	231
Explorer.....	231
Memosens PH Diagnostics	232
Module Diagnostics.....	232
Sensor Monitor.....	232
Calibration Timer	233
Tolerance Adjustment	233
Sensor Wear Monitor	234
Cal Record	235
Sensor Network Diagram	235
Statistics.....	235
Diagnostics of Unical 9000	236
Unical Status	236
Unical Network Diagram	236
Diagnostics of Uniclean 900	237
Uniclean Status	237
Setting Diagnostics Functions as Favorite	238
Message List	240
Messages	241
Error Messages of Unical 9000(X)	250
Error Messages of Uniclean 900(X)	256

Table of Contents

FIU 3400-141 Module

Specifications	260
Appendix:	262
Minimum spans for current outputs – Memosens PH	262
Minimum spans for current outputs – Memosens COND.....	263
Minimum spans for current outputs – Memosens CONDI	264
Minimum spans for current outputs – Memosens OXY	265
Buffer table "Mettler-Toledo"	267
Buffer table "Knick CaliMat"	268
Buffer table "DIN 19267"	269
Buffer table "NIST standard" (DIN 19266: 2000-01)	270
Buffer table "Techn. buffers to NIST".....	271
Buffer table "Hamilton"	272
Buffer table "Kraft"	273
Buffer table "Hamilton A"	274
Buffer table "Hamilton B"	275
Buffer table "HACH"	276
Buffer table "Ciba"	277
Buffer table "Reagecon"	278
SW 3400-002: Specifiable Buffer Sets	279
Index	290
Quick Access	306

Intended Use

The module is a multifunctional communication unit providing two parallel usable RS-485 ports. It allows

- connecting up to two Memosens sensors
- connecting a Memosens sensor and a Uniclean, Unical probe controller

(InduCon sensors continue to be supported.)

When operated in the

- Memosens / Memosens

mode, the FIU 3400-141 module allows connection of up to two sensors. That means, it "simulates" two measuring modules.



NOTICE!

Please note that generally only one further module may be installed in the Protos 3400 when the FIU 3400-141 module is used!

Safety Information

Caution!

Never try to open the module! If a repair should be required, return the module to our factory.

If the specifications in the instruction manual are not sufficient for assessing the safety of operation, please contact the manufacturer to make sure that your intended application is possible and safe.

Be sure to observe during installation:

Switch off power supply before replacing or inserting a module!

Conformity with FDA 21 CFR Part 11

In their directive “Title 21 Code of Federal Regulations, 21 CFR Part 11, Electronic Records; Electronic Signatures” the US American health agency FDA (Food and Drug Administration) regulates the production and processing of electronic documents for pharmaceutical development and production. This results in requirements for measuring devices used for corresponding applications. The following features ensure that the Protos 3400 modular process analysis system meets the demands of FDA 21 CFR Part 11:

Electronic Signature

Access to the device functions is regulated and limited by individually adjustable codes – “Passcodes”. This prevents unauthorized modification of device settings or manipulation of the measurement results. Appropriate use of these passcodes makes them suitable as electronic signature.

Audit Trail Log

Every change of device settings can be automatically recorded and documented in the Audit Trail Log on the SmartMedia card. The recording can be encrypted.

Software Version

FIU 3400-141 Module

Protos 3400 Device Software

The FIU 3400-141 module is supported by software version 8.0 or higher.

FIU 3400-141-2 Module Software

Software version 3.x

Query actual device/module software

When the analyzer is in measuring mode:

Press **menu** key, open Diagnostics menu: Device description

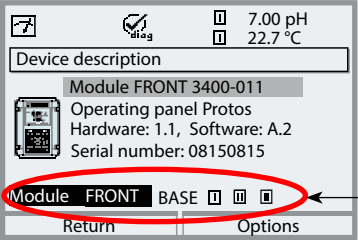
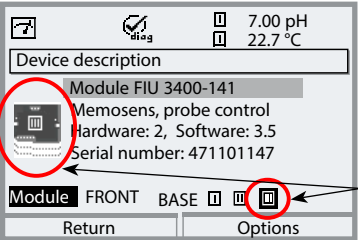
Menu	Display	Device description
		Device hardware and software version Provides information on all modules installed: Module type and function, serial number, hardware and software version and device options. Select the different modules (FRONT, BASE, slots 1 - 3) using the arrow keys.
		Query module software Module FIU 3400-141, hardware and software version, serial number – here installed in slot 3.

Modular Concept

Basic unit, measuring modules, additional functions

The Protos 3400(X) is an expandable modular process analysis system. The basic unit (FRONT and BASE modules) provides three slots which can be equipped by the user with any combination of measuring or communication modules. The software capabilities can be expanded by additional functions (options). Additional functions must be ordered separately. They are supplied with a device-specific TAN for function release.

Protos 3400(X) Modular Process Analysis System



Additional functions
Activation via device-specific TAN

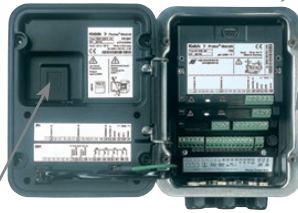

Measuring modules

- pH / ORP / Temp
- O₂ / Temp
- Noncontacting conductivity / Temp
- Contacting conductivity / Temp
- MS (Memosens interface)



SmartMedia card
Data recording

ProgaLog 3000
Windows® software for parameter setting and data evaluation

3 module slots
for free combination of measuring and communication modules

Communication modules

- OUT (additional switching and current outputs)
- PID (analog and digital controller)
- Profibus PA
- Foundation Fieldbus
- FIU (Memosens, probe controller) (software occupies 2 slots)
- Unical probe controller

Documentation

The basic unit is accompanied by a CD-ROM containing the complete documentation.

Latest product information as well as user manuals for earlier software releases are available at

www.knick.de

Short Description

Short Description: FRONT Module

4 captive screws

for opening the analyzer

(**Caution!** Make sure that the gasket between FRONT and BASE is properly seated and clean!)

Transflective LC graphic display

(240 x 160 pixels)

white backlighting, high resolution and high contrast.

Measurement display

User interface

with plaintext menus as recommended by NAMUR.

Menu texts can be switched to: German, English, French, Italian, Swedish/Portuguese or Spanish. Intuitively acquirable menu logic, based on Windows standards.

Secondary displays

2 softkeys

with context-sensitive functions.

Red LED

signals failure (On) or maintenance request/function check (flashing) according to NE 44.

Green LED

Voltage supply okay

Control panel

3 function keys

(menu, meas, enter)

and 4 arrow keys for menu selection and data entry

5 self-sealing cable glands

M20 x 1.5

for entry of voltage supply and signal lines



Short Description: Menu Structure

Basic functions: Calibration, Maintenance, Parameter setting, Diagnostics

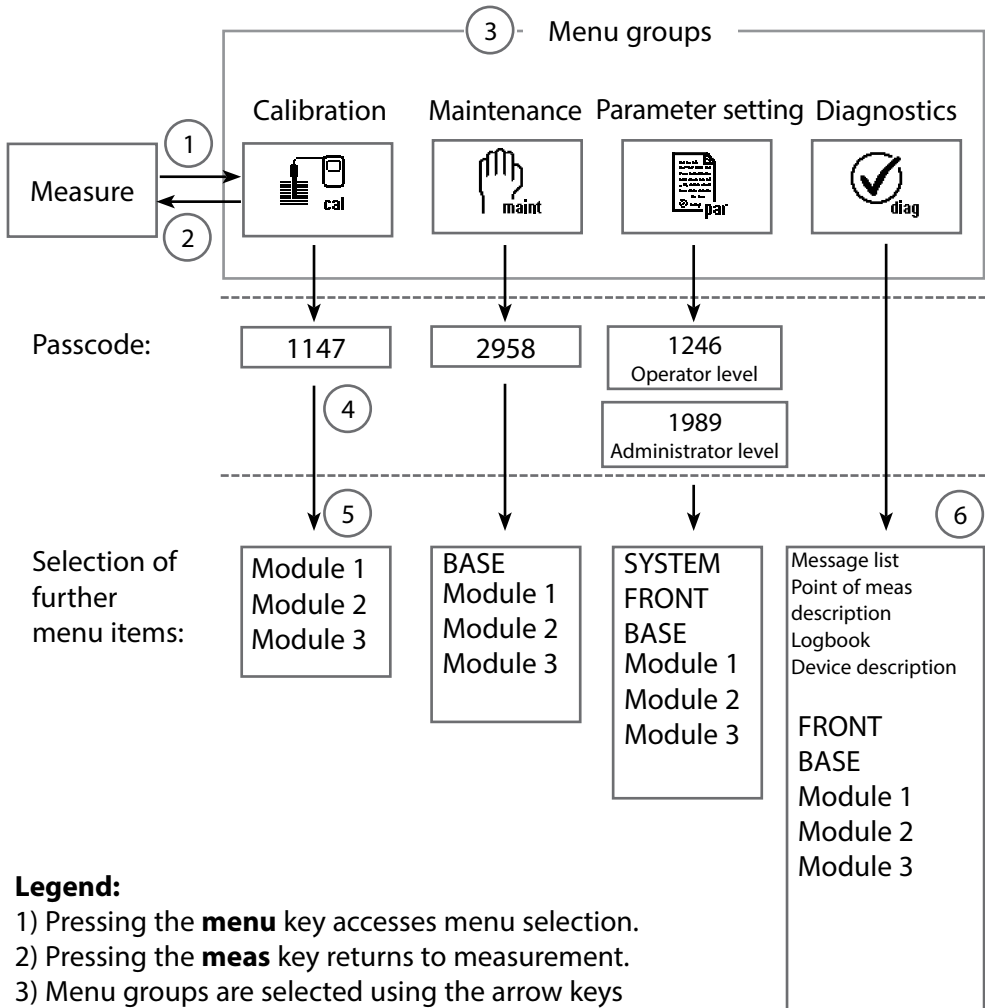

Legend:

- 1) Pressing the **menu** key accesses menu selection.
- 2) Pressing the **meas** key returns to measurement.
- 3) Menu groups are selected using the arrow keys
- 4) Press **enter** to confirm, enter passcode
- 5) Further menu items are displayed
- 6) Selected functions of the Diagnostics menu can be recalled via softkey even when in measuring mode

Short Description: FRONT Module

View into the open device (FRONT module)

Slot for SmartMedia card

- Data recording
The SmartMedia card expands the measurement recorder capacity to > 50000 records.
- Exchange of parameter sets
5 parameter sets can be stored on the SmartMedia card, 2 of them can be loaded simultaneously to the analyzer and be switched by remote control. Parameter sets can be transmitted from one analyzer to the other.
- Function expansions
are possible with additional software modules, which are released using transaction numbers (TAN).
- Software updates

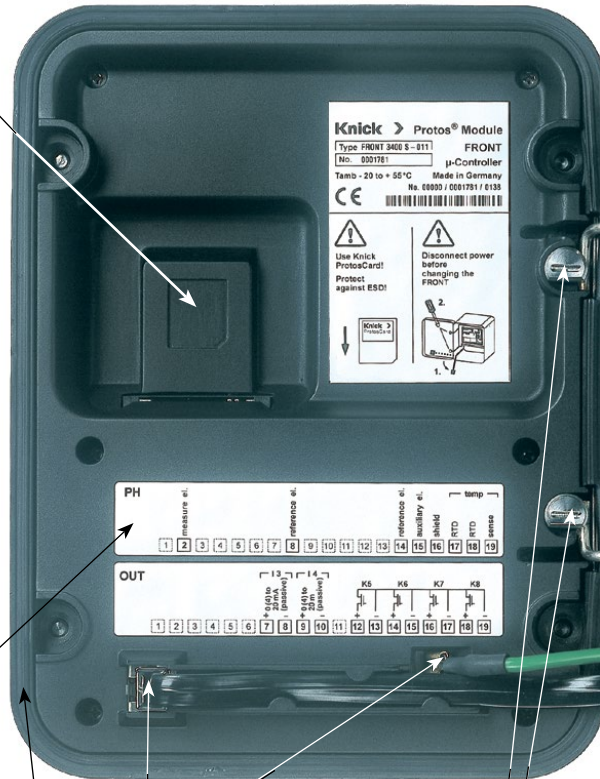

Terminal plates of "hidden" modules

Each module comes with an adhesive label containing the contact assignments. This label should be stuck to the inner side of the front (as shown). Then, the terminal assignments remain visible even if further modules are inserted.

Replacing the front module

Pull off power cord and ground wire. To separate the FRONT module from the BASE module, turn the retaining screws of the pivot hinge by 90°.

The circumferential sealing

guarantees IP 65 protection and allows spray cleaning / disinfection.

NOTICE! Keep clean!

Short Description: BASE Module

View into the open device (BASE module, 3 function modules installed)

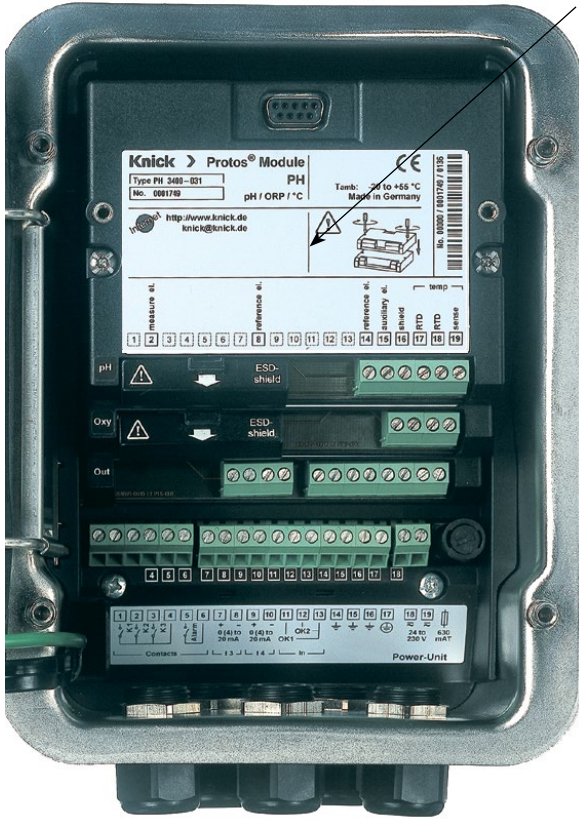

Module equipment

Module identification: Plug & Play.
Up to 3 modules can be combined as desired. Several input and communication modules are available.



Notice

Only one module can be connected in addition to a FIU 3400(X)-140/141 module.

BASE module

2 current outputs (free assignment of process variable) and 4 relay contacts, 2 digital inputs.

VariPower broad-range power supply unit, 20 ... 265 V AC/DC, suitable for all public mains supplies in the world.

Power supply units, Ex version:

100 ... 230 V AC or
24 V AC/DC



WARNING!





Do not touch the terminal compartment, there may be dangerous contact voltages!

Important notice concerning SmartMedia Card

The SmartMedia card may be inserted or replaced with the power supply switched on. Before a memory card is removed, it must be "closed" in the maintenance menu. When closing the device, make sure that the sealing is properly seated and clean.

Terminal Plate

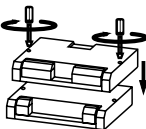
FIU 3400-141-2 Module Terminal Plate:

Knick > Protos[®] Module										 Tamb: -20 to +55 °C Made in Germany										
Type FIU 3400-141-2		ComFu [®] Memosens [®] Uniclean/Unical [®]																		
No. _____		 http://www.knick.de knick@knick.de								 					 00000 66161/0000000					
ComFu		Memosens InduCon II				Memosens InduCon I				Unical Uniclean										
BZ 3.5V	shield	GA	BE	GND	BN 3V	shield	GA	BE	GND	BN 3V	shield	GA	BE	GND	BN 3V	shield	GA	BE	GND	BN 6.8V
1	2	3	4	5	6	7	8	9	10	11	12	13	14	15	16	17	18	19		

Inserting the Module

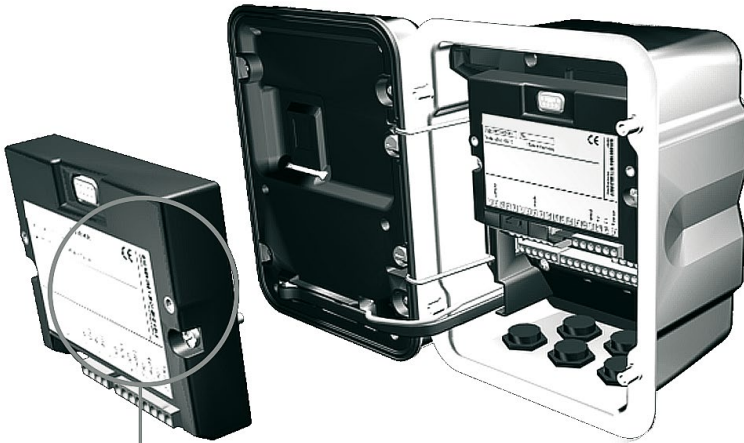

Thanks to the staggered arrangement of connectors and fastening screws the terminal strips of all modules are easy to access.

Make sure that the cable glands are tightly closed to protect against humidity.

1. Switch off power supply
2. Open the device (loosen the 4 screws at the front)
3. Place module in slot (D-SUB connector)
4. Tighten fastening screws of the module
5. Connect signal lines
6. Close device, tighten screws at the front
7. Switch on power supply
8. Assign process variables to outputs
9. Set parameters

FIU 3400-141 Digital Module

The Protos FIU 3400-141 module provides four RS-485 interfaces with power supply, 2 of which can be used in parallel:

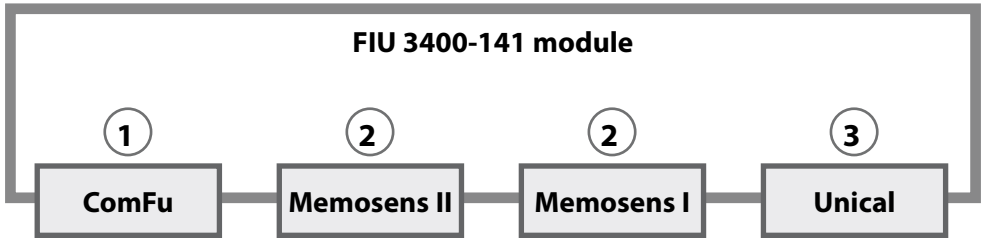

- ① The "ComFu" RS 485 interface is not available for the FIU 3400-141 module and must not be connected.
- ② The "Memosens I" and "Memosens II" RS485 interfaces are each used for communicating with one digital, intelligent sensor.
- ③ The "Unical" RS 485 interface allows the connection of a controller for retractable fittings.

Connecting Memosens Sensors

Memosens sensors allow storing data and digitizing the analog signal directly in the sensor. Memosens sensors supply the actual process values including temperature as well as calibration, adjustment and process-related data, such as operating time and information concerning extreme process conditions. The calibration data are stored in the sensor. This allows calibrating, adjusting, regenerating or cleaning the sensors in a lab, far from the point of measurement. On the site, you simply replace the used sensors by calibrated sensors.

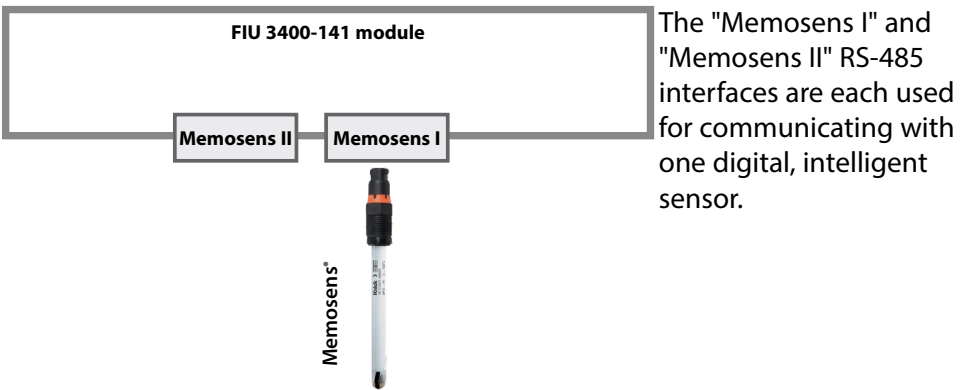

The "Memosens I" and "Memosens II" RS-485 interfaces are each used for communicating with one digital, intelligent sensor.

Connection of Memosens (RS-485 Cable)

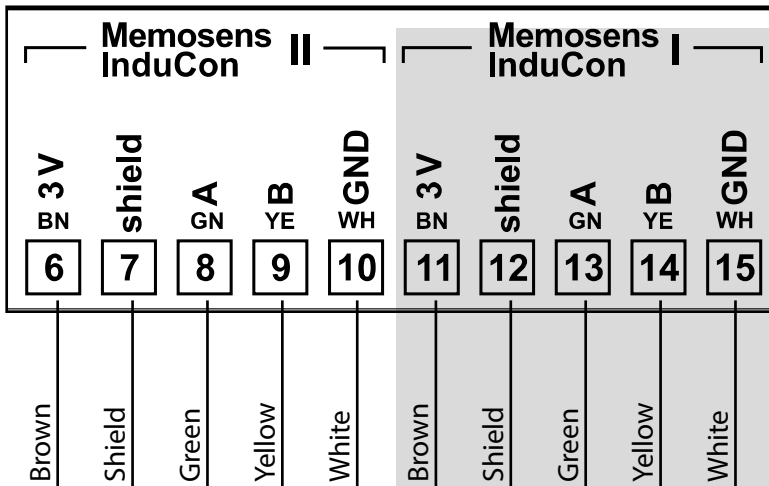

Memosens: 2nd Measuring Channel

SW3400-014: Activating a 2nd channel for Memosens sensors



For connecting 2 Memosens sensors to the FIU 3400-141 module, you require the additional function SW3400-014.

The additional functions are device-specific.

When ordering an additional function, you therefore have to specify the serial number of your FRONT module in addition to the respective order number. (The FRONT module contains the Protos system control).

The manufacturer then supplies a TAN (transaction number) to release the additional function.

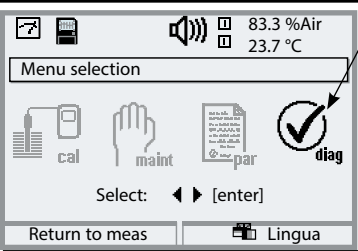
Serial number of FRONT module

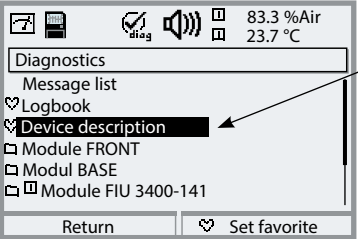
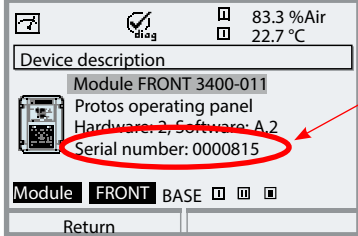
Menu	Display	Serial number FRONT module
		Menu selection Open diagnostics. From the measuring mode: Press menu key to select menu. Select diagnostics using arrow keys, confirm by pressing enter .
		Diagnostics Select "Device description" using arrow keys, confirm by pressing enter .
		Device description Enter this <u>serial number</u> and the <u>hardware version</u> when ordering an additional function.

Activating an Additional Function

Select menu: Parameter setting/System control/Release of options

Note: The TAN for releasing an additional function is only valid for the device with the corresponding serial number (see previous page).

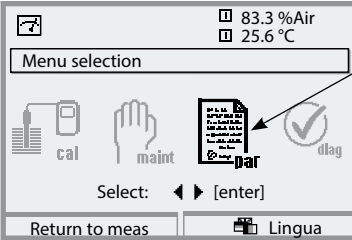
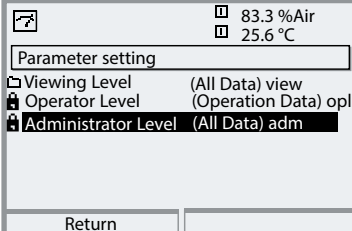
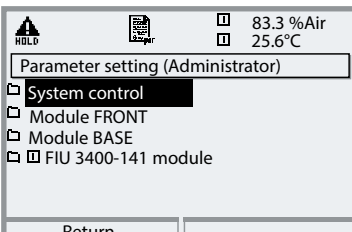
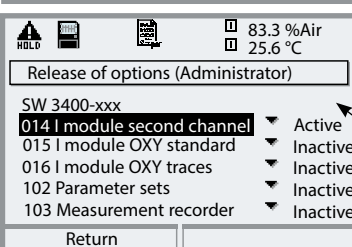
Menu	Display	Activate additional function
		<p>Menu selection</p> <p>Open parameter setting. From the measuring mode: Press menu key to select menu. Select parameter setting using arrow keys, press enter to confirm.</p>
		<p>Parameter setting</p> <p>Select Administrator level using arrow keys, press enter to confirm. Enter passcode and confirm (Passcode as delivered: 1989)</p>
		<p>Select system control using arrow keys, confirm by pressing enter. Then select "Release of options" using arrow keys, confirm with by pressing enter.</p>
		<p>Release of options</p> <p>Select the additional function to be released. Set option to "active". Enter the TAN at the prompt. (Note: The TAN is only valid for the device with the corresponding serial number, see previous page.) The option is available after the TAN has been entered.</p>

Menu Selection

After switching on, the analyzer performs an internal test routine and automatically detects the number and type of modules installed. Then, the analyzer goes to measuring mode.

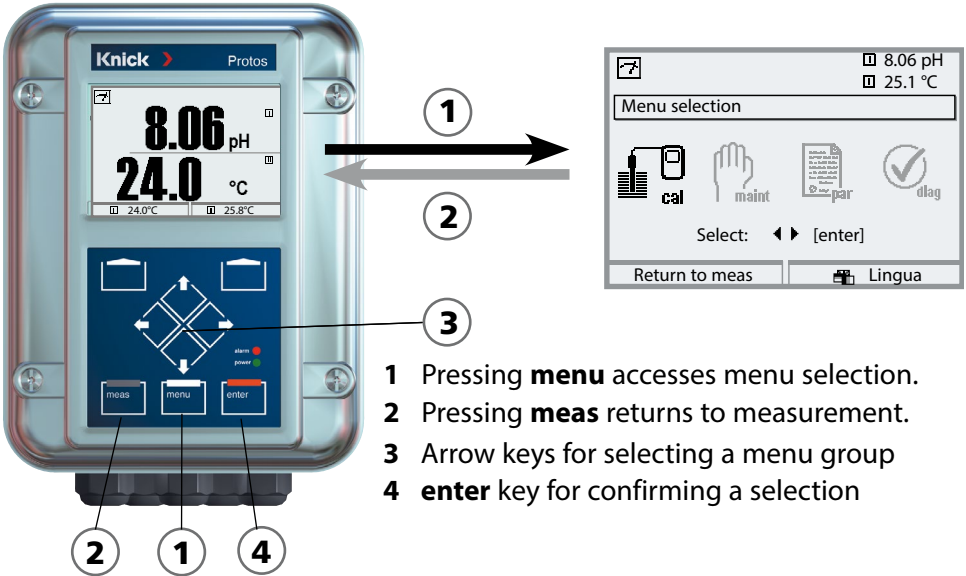

Menu Structure

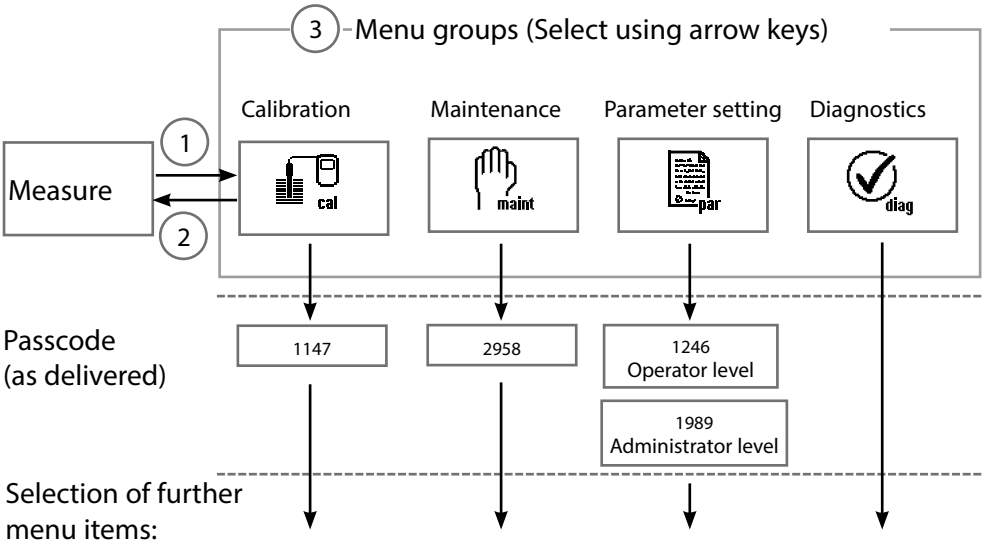

Passcode Entry

To enter a passcode

Select the position using the left/right keys, then edit the number using the up/down keys. When all numbers have been entered, press **enter** to confirm.

To change a passcode

- Open the menu selection (**menu** key)
- Select parameter setting
- Administrator level, enter passcode
- Select System control: Passcode entry

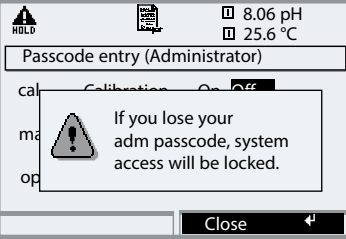
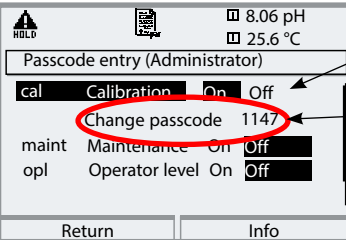
Menu	Display	System control: Passcode entry								
	 	<h3>Changing a Passcode</h3> <h4>“Passcode Entry” Menu</h4> <p>When this menu is opened, the analyzer displays a warning (Fig.). Passcodes (factory settings):</p> <table border="0"> <tr> <td>Calibration</td> <td>1147</td> </tr> <tr> <td>Maintenance</td> <td>2958</td> </tr> <tr> <td>Operator level</td> <td>1246</td> </tr> <tr> <td>Administrator level</td> <td>1989</td> </tr> </table> <p>If you lose the passcode for the Administrator level, system access will be locked! Please consult our technical support!</p> <p>To change a passcode Select “On” using arrow keys, confirm with enter. Select the position using the left/right keys, then edit the number using the up/down keys. When all numbers have been entered, confirm with enter.</p>	Calibration	1147	Maintenance	2958	Operator level	1246	Administrator level	1989
Calibration	1147									
Maintenance	2958									
Operator level	1246									
Administrator level	1989									



Configuring the Measurement Display

Select menu: Parameter setting/Module FRONT/Measurement display

Pressing **meas** (1) returns the analyzer to the measuring mode from any function.

All process variables coming from the modules can be displayed. The table on the next page describes how to configure the measurement display.

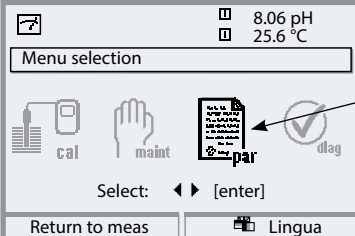

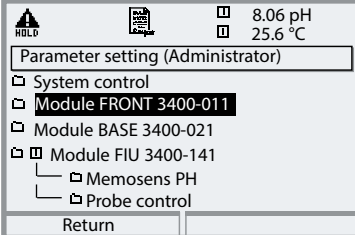
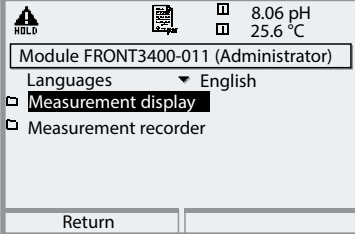
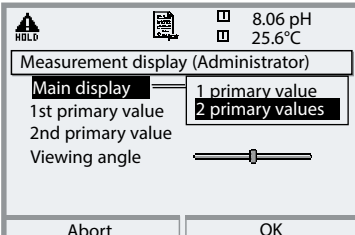
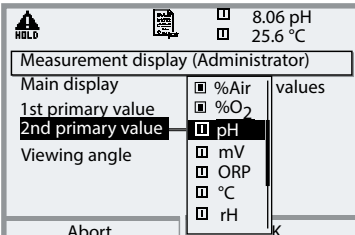
Menu	Display	Configuring the Measurement Display
	 <p>8.06 pH 25.6 °C</p> <p>Menu selection</p> <p>cal maint par dlag</p> <p>Select: ◀ ▶ [enter]</p> <p>Return to meas Lingua</p>	<p>Configure measurement display</p> <p>Press menu key to select menu. Select parameter setting using arrow keys, confirm with enter. Select: "Administrator level": Passcode 1989 (default setting).</p>
	 <p>HOLD 8.06 pH 25.6 °C</p> <p>Parameter setting (Administrator)</p> <ul style="list-style-type: none"> System control Module FRONT 3400-011 Module BASE 3400-021 Module FIU 3400-141 <ul style="list-style-type: none"> Memosens PH Probe control <p>Return</p>	<p>Parameter setting: Select "Module FRONT"</p> <p>Note: For software reasons, the "FIU 3400-141" module occupies 2 slots. When a second module is inserted, it is indicated with slot III, for ex.</p>
	 <p>HOLD 8.06 pH 25.6 °C</p> <p>Module FRONT3400-011 (Administrator)</p> <ul style="list-style-type: none"> Languages English Measurement display Measurement recorder <p>Return</p>	<p>Front module: Select "Measurement display"</p>
	 <p>HOLD 8.06 pH 25.6 °C</p> <p>Measurement display (Administrator)</p> <ul style="list-style-type: none"> Main display 1 primary value 2 primary values 1st primary value 2nd primary value Viewing angle <p>Abort OK</p>	<p>Measurement display: Set the number of primary values (large display) to be displayed</p>
	 <p>HOLD 8.06 pH 25.6 °C</p> <p>Measurement display (Administrator)</p> <ul style="list-style-type: none"> Main display 1st primary value 2nd primary value Viewing angle <ul style="list-style-type: none"> %Air %O₂ pH mV ORP °C rH <p>Abort OK</p>	<p>Select process variable(s) to be displayed and confirm with enter.</p> <p>Pressing the meas key returns to measurement.</p>

Parameter Setting: Operating Levels

Viewing level, Operator level, Administrator level

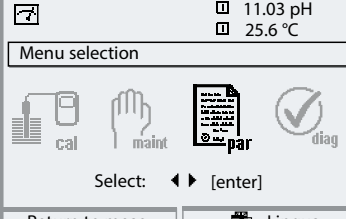
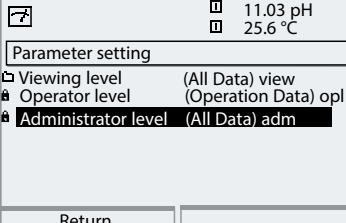
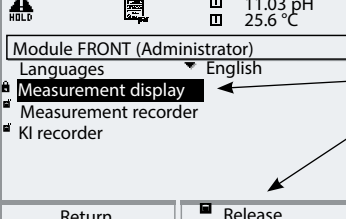
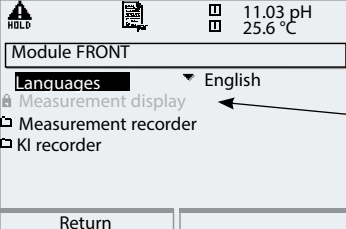

Note: HOLD mode (Setting: BASE module)

Menu	Display	Viewing level, Operator level, Administrator level
		<p>Access Parameter Setting</p> <p>From the measuring mode: Press menu key to select menu. Select parameter setting using arrow keys, confirm by pressing enter.</p>
		<p>Administrator Level</p> <p>Access to all functions, also passcode setting. Releasing or blocking function for access from the Operator level.</p>
		<p>Functions which can be blocked for the Operator level are marked with the "lock" symbol. The functions are released or blocked using the softkey.</p>
		<p>Operator Level</p> <p>Access to all functions which have been released at the Administrator level. Blocked functions are displayed in gray and cannot be edited (Fig.).</p> <p>Viewing Level</p> <p>Display of all settings. No editing possible!</p>

Parameter Setting: Lock Functions

Administrator level: Enable / lock functions for Operator level

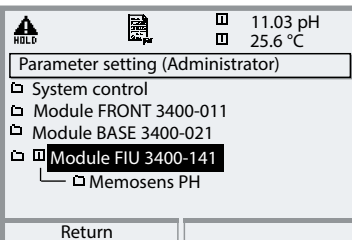
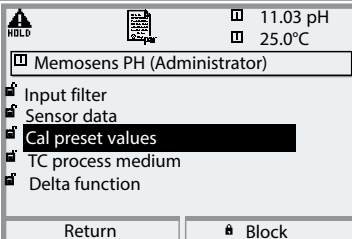
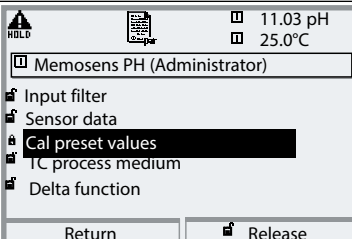
Note: HOLD mode (Setting: BASE module)

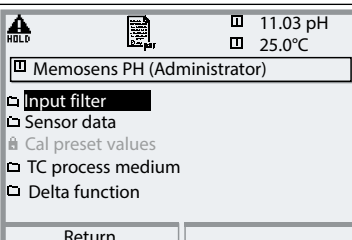
Menu	Display	Administrator level: Enable / lock functions
		<p>Example: Blocking access to the calibration adjustments from the Operator level</p> <p>Access Parameter Setting Select Administrator level. Enter passcode (1989). Select "Memosens PH" (e.g.) using arrow keys, confirm by pressing enter.</p>
		<p>Select "Cal preset values" using arrow keys. "Block" with softkey.</p>
		<p>Now, the "Cal preset values" line is marked with the "lock" icon. This function cannot be accessed from the Operator level any more. The softkey function changes to "Release".</p>
		<p>Access Parameter Setting Select <u>Operator level</u>, passcode (1246). Select "Memosens PH" (e.g.). Now, the locked function is displayed in gray and marked with the "lock" icon.</p>

Documenting Parameter Setting

You must reproducibly document all parameter settings in the device to achieve a high level of system and device security according to GLP. For that purpose, an Excel file is provided (on the CD-ROM shipped with the basic device) to enter the parameter settings.

The Excel file provides one worksheet for each module with columns for the following parameters: Factory settings, parameter set A, parameter set B. Enter your settings as parameter set A or B.

The gray cells in the parameter set B column cannot be modified since they contain sensor-specific values which cannot be changed by parameter set switchover. Here, the values listed under parameter set A apply.

Documenting Parameter Setting

	A	B	C	D	E	F
1						
2	1.	Point of measurement				Access via menu:
3		Protos 3400				
4	1.1.	Configured by / date:				
5						
6						
7	2.	Device description	Hardware	Software	Serial number	Diagnostics / Device description
8	2.1.	Operating panel 3400-011:				Diagnostics / Device description / Front
9	2.2.	3400-021 BASE module:				Diagnostics / Device description / BASE
10	2.3.	Module slot [I] :				Diagnostics / Device description / I
11	2.4.	Module slot [II] :				Diagnostics / Device description / II
12	2.5.	Module slot [III] :				Diagnostics / Device description / III
13						
14						
15		FRONT Module				
16	3.	FRONT module settings	Factory setting	Parameter set A	Parameter set B	
17	3.1.	Language:	English			Parameter setting (Administrator) / Module FRONT ...
18						
19	3.1.1	Measurement display:				
20		Main display	2 primary values			Parameter setting (Administrator) / Module FRONT ... / Measurement display
21		1st primary value (module/value):	depending on module			
22		2nd primary value (module/value):	depending on module			
23		Display format (pH)	xx.xx pH			
24		Viewing angle	Middle			
25						
26	3.3.	Secondary display				Setting via softkeys if selected in Function Control Matrix
27		Display value, left	-			
28		Display value, right	-			
29						
30	3.4.	Measurement recorder:	Option SW3400-103			Parameter setting (Administrator) / Module FRONT ... / Measurement recorder
31		Time base (t / pixel)	1 min			
32		Zoom function (10x)	Off			
33		Min/Max display	On			
34	3.4.1	Channel 1: Process variable	depending on module			
35		Start	0.00			
36		End	14.00			
37	3.4.2	Channel 2: Process variable	depending on module			
38		Start	-50.0			
39		End	150.0			
40						
41	3.5	KI recorder	Option SW3400-001			Parameter setting (Administrator) / Module FRONT ... / KI recorder
42		Protos 3400 / Protos 3400 Options	Protos 3400 Tables	PH 3400-032	PH 3400-033	PH 3400-035
43						FTU_PH 3400-036

From the application window of the Excel file, select the worksheet for the module the parameter settings of which you want to document. Set the parameters of the respective module and enter the selected values in the corresponding cells of the module worksheet.

NOTICE!

Display	The "HOLD" mode is active during parameter setting.
	<p>HOLD. The NAMUR "HOLD" contact (function check) is active (factory setting: Module BASE, Contact K2, N/O contact). Current output response is user-defined:</p> <ul style="list-style-type: none"> • Current meas.: The currently measured value appears at the current output • Last usable value: The last measured value is held at the current output • Fixed 22 mA: The output current is at 22 mA

ProgaLog 3000 Software (Option) for Configuration and Documentation

The ProgaLog 3000 software is available for convenient configuration of the Protos 3400(X) process analysis system. The user interface can be switched to the Protos display languages English, German, French, Spanish, Italian, Swedish or Portuguese. The software comes on CD-ROM. It runs under Windows® 8 / 7 / XP. A card reader for SmartMedia cards is required for transferring the configuration files between PC and Protos 3400.

Configuration with ProgaLog 3000

Insert a SmartMedia card formatted as "memory card" into the analyzer. First, the configuration data are written to the SmartMedia card. These data can then be read and edited by the ProgaLog 3000 software.

1. Save the configuration data at the Protos 3400(X)

Parameter setting/System control/Copy configuration.

With "Save" configuration, the complete device configuration (except the passcodes) is written on the memory card.

2. Close and remove the SmartMedia card

Select "Maintenance / Close memory card", then remove the card.

3. Read out SmartMedia card with "ProgaLog 3000"

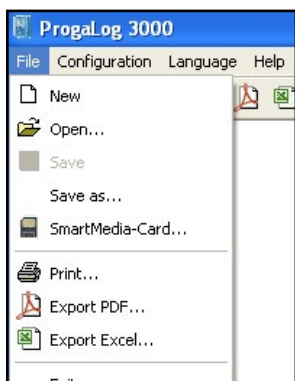

Open the "File / SmartMediaCard" menu of the ProgaLog 3000 software to read out the configuration data stored on the SmartMedia card. Now, you can edit all parameters at your PC. Save the edited configuration file to the SmartMedia card. Then, insert the SmartMedia card into the Protos 3400(X) analyzer.

Fig.: ProgaLog 3000 menu: File

ProgaLog 3000 Software

for Configuration and Documentation

4. Edit configuration data using ProgaLog 3000

When the configuration data have been loaded, the software lists the connected modules with all available configuration parameters:

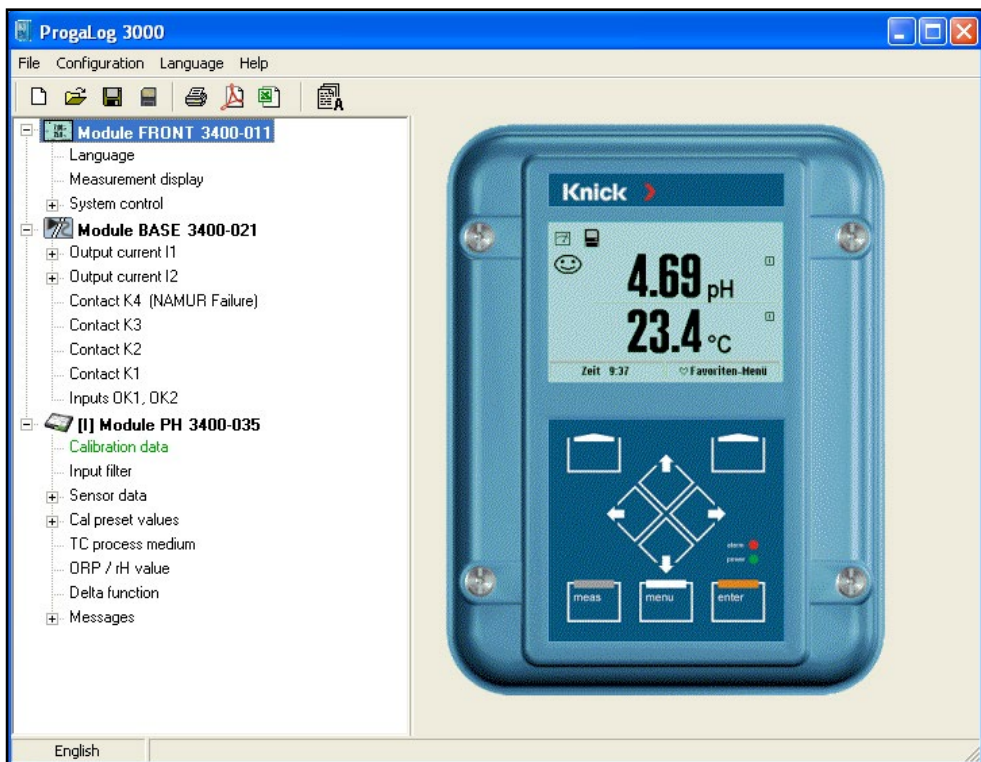
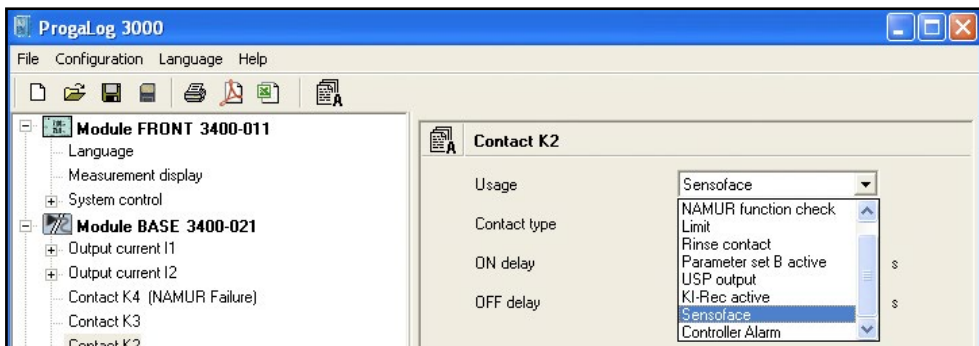

Fig.: ProgaLog 3000 configuration data

The parameters are listed according to the modular device structure. All configuration parameters (except the "Sensor data details", which are determined by digital sensors) can be edited at the PC. After having finished the configuration, save the data to the SmartMedia card.

ProgaLog 3000 Software for Configuration and Documentation

Configuring the parameters, e.g. relay contact usage:



Input errors are indicated by red highlighting:

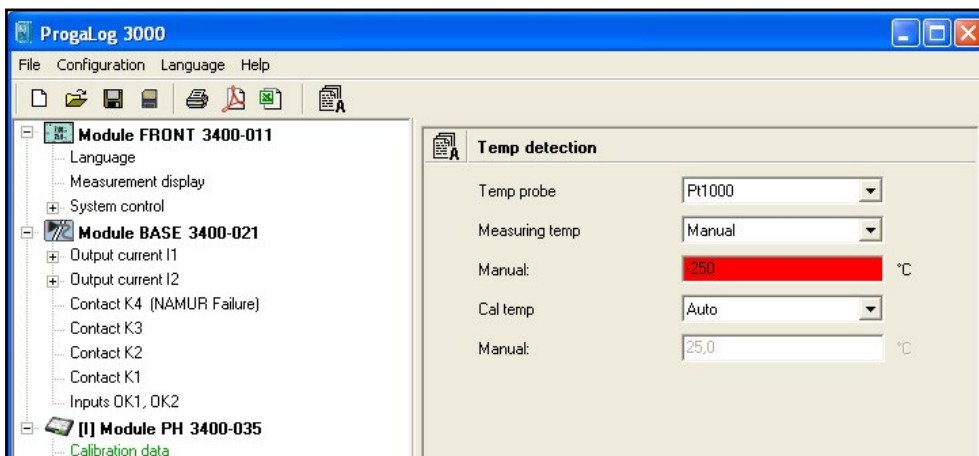

5. Save the configuration data to SmartMedia card

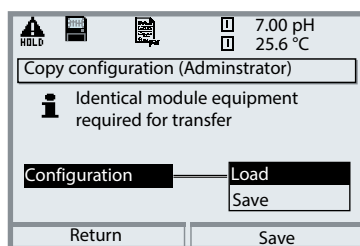

6. Load the configuration data to the Protos 3400(X)

Parameter setting / System control /
Copy configuration.

Select "Load configuration" to write the complete device configuration (except the passcodes) to the Protos 3400(X).

ProgaLog 3000 Software

for Configuration and Documentation

Configuration using "ProgaLog 3000"

In the "Configurator" menu you can preconfigure a complete Protos 3400(X) process analysis system with up to 3 modules at your PC.

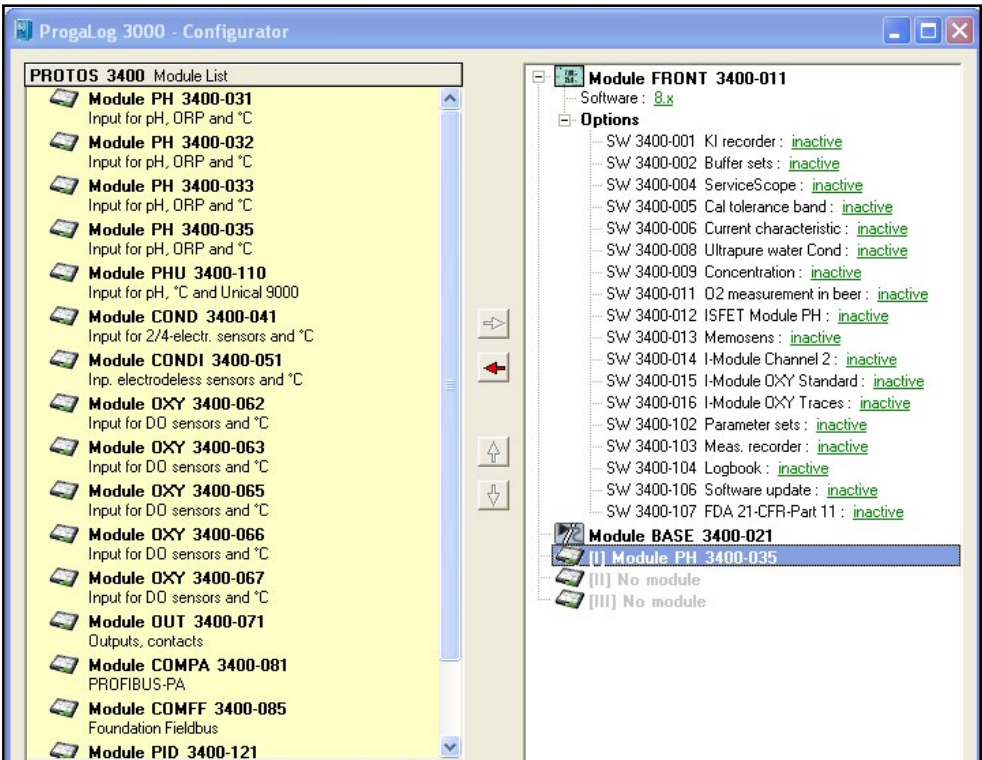



1. Select your configuration from the modular system components offered in the left-hand field.
2. Click the right arrow (-->) to add the components or remove components by clicking (<--).
3. Now configure the parameters for the selected system components.
4. Save the configuration.

You can save the configuration to a memory card that has been pre-formatted in the Protos 3400(X) and transfer them to analyzers with identical module configurations.

Module Configuration: Operating Mode

Open parameter setting

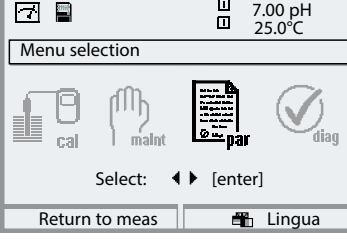
Note: "HOLD" mode active.

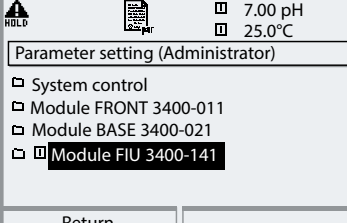
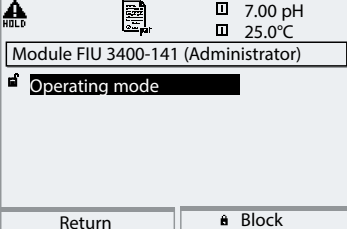
Menu	Display	Parameter setting
		<p>Open parameter setting</p> <p>From the measuring mode: Press menu key to select menu. Select parameter setting using arrow keys, press enter to confirm. Passcode 1989 (To change passcode: Parameter setting/System control/Passcode entry)</p>
	 	<p>HOLD mode</p> <p>Current outputs and relay contacts behave as configured.</p> <p>Select "FIU 3400-141" module. Press enter to confirm. Select "Operating mode" using arrow keys, press enter to confirm.</p>
		<p>The possible operating modes are displayed.</p> <p>For 2-channel operation, you have to activate the additional function SW 3400-014 (see "Memosens: 2nd Channel on Page 35).</p> <p>To take over the new settings, the analyzer will restart automatically.</p>

Memosens PH Parameter Setting

Selecting the mode and process variable (pH).

Note: "HOLD" mode active

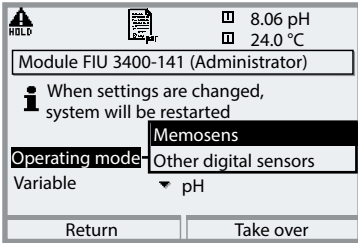
Menu	Display	Parameter setting
		<p>Select mode and process variable. Select: Parameter setting/ Module FIU 3400-141/ Operating mode: Memosens Variable: PH. When you have changed the operating mode or the process variable (or selected it for the first time), press the "Take over" softkey to confirm.</p>

After restart, a connected Memosens sensor is displayed immediately:

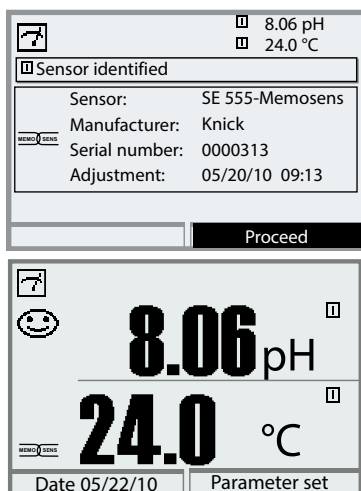

All sensor-typical parameters are automatically sent to the analyzer.

These are, for example, the measuring range, zero and slope of the sensor. Without any further parameter setting, measurement starts at once, the measuring temperature is simultaneously detected.

With "Plug&Measure", premeasured Memosens sensors can immediately be used for measurement without previous calibration.

The Memosens icon is displayed as long as a Memosens sensor is connected.

Memosens PH Parameter Setting

Note: HOLD mode active

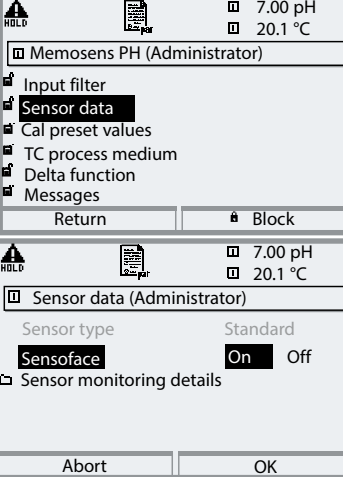
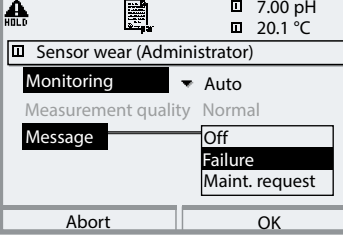
Menu	Display	Parameter selection
		<p>Sensor data</p> <p>Memosens sensors provide most of the parameters automatically. Sensoface provides information on the sensor condition (evaluating the sensor data). Great deviations are signaled. The following parameters are monitored: slope, zero, glass impedance, response time. Sensoface is displayed when Sensocheck has been activated during parameter setting.</p> <p>Sensor monitoring details</p> <p>For some parameters, you can choose between Off/Auto/Individual. Off: No evaluation and no display in the sensor monitor. Auto: The parameters are read out directly from the sensor or are adjusted by the system. They are displayed in gray and cannot be edited. Individual: You must enter the parameters.</p>
		<p>Messages</p> <p>Limit violations can be signaled by a message (either "failure" or "maintenance request").</p>

Parameter Setting (Memosens PH)

Parameter	Default	Selection / Range
Input filter		
Pulse suppression	Weak	Off, Weak, Medium, Strong
Input filter	010 sec	xxx sec (entry)
Sensor data		
Sensoface	On	On, Off
Sensor monitoring details		
Sensor parameters	Auto	<ul style="list-style-type: none"> - Slope - Zero point - Temperature - Sensocheck glass electrode - Response time - Sensor wear - SIP counter (default: Off) - Sensor operating time (default: Off)
Cal preset values		
Calimatic buffers	Knick CaliMat	Knick CaliMat, Mettler-Toledo, DIN 19267, NIST standard, NIST technical, Hamilton, Kraft, Hamilton A, Hamilton B, Hach, Ciba, Reagecon, Table
Drift check	Standard	Fine: 1.2 mV/min (Abort after 180 sec) Standard: 2.4 mV/min (Abort after 120 sec) Coarse: 3.75 mV/min (Abort after 90 sec)
Cal timer monitoring	Auto: 0168h	Auto, Off, Individual
Adaptive cal timer	Off	Off, On
Cal tolerance band check:	Off	Off, On
Cal tolerance zero	+00.20 pH	(entry)
Cal tolerance slope	+002.0 mV/pH	(entry)
TC process medium		
TC	Off	Off, Linear, Ultrapure water, Table Linear: enter temperature factor +XX.XX %/K Table: TC values adjustable in 5°C steps
Delta function		
Delta function	Off	Off, pH
Messages		
Messages pH value	Off	Off, Variable limits
Messages mV value	Off	Off, Variable limits

Tolerance adjustment (additional function SW 3400-005) During calibration this function checks the zero and slope values and automatically performs an adjustment when the tolerance band is exceeded. The parameters are stored in the tolerance band recorder (Diagnostics menu). See following page for activation.

Activating the Cal Tolerance Band (Memosens PH)

Select menu: Parameter setting/System control/Release of options

Note: The TAN for releasing an additional function is only valid for the device with the corresponding serial number!

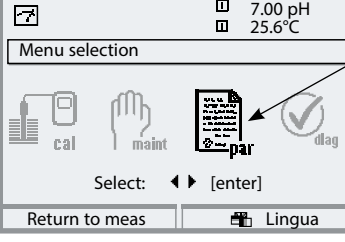
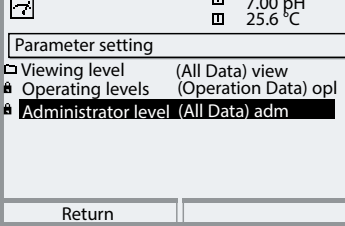
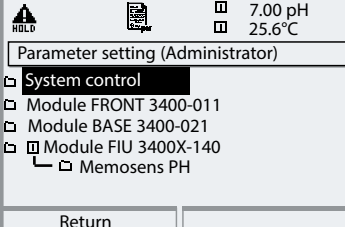
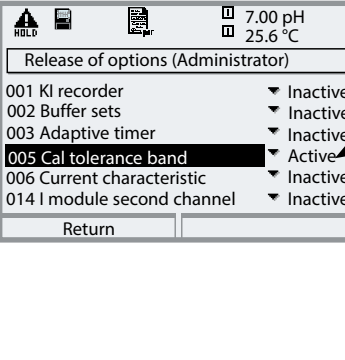
Menu	Display	Activate additional function
		<p>Menu selection</p> <p>Open parameter setting. From the measuring mode: Press menu key to select menu. Select parameter setting using arrow keys, press enter to confirm.</p>
		<p>Parameter setting</p> <p>Select Administrator level using arrow keys, press enter to confirm. Enter passcode and confirm (Passcode as delivered: 1989)</p>
		<p>Select System control using arrow keys, press enter to confirm. Then select "Release of options" using arrow keys, press enter to confirm.</p>
		<p>Release of options</p> <p>Select the additional function to be released ("Cal tolerance band"). Set option to "active". Enter the TAN at the prompt. (Note: The TAN is only valid for the device with the corresponding serial number, see previous page.) The option is available after the TAN has been entered.</p>

Parameter Setting (Memosens PH)

TC process medium

Note: HOLD mode active

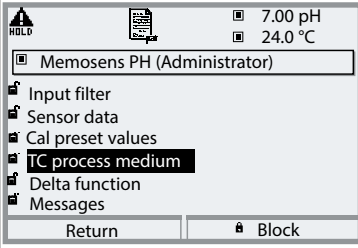
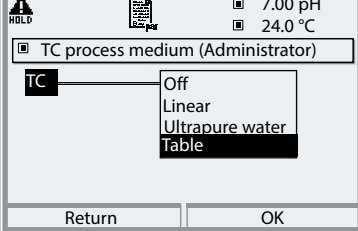
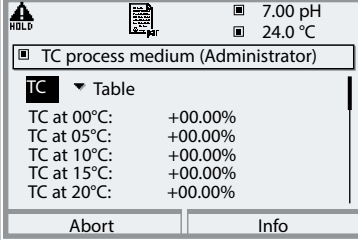
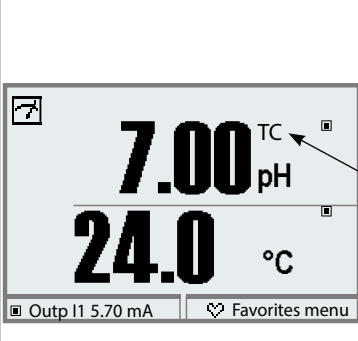
Menu	Display	TC process medium										
	 <p> <input type="checkbox"/> 7.00 pH <input type="checkbox"/> 24.0 °C <input type="checkbox"/> Memosens PH (Administrator) </p> <ul style="list-style-type: none"> Input filter Sensor data Cal preset values TC process medium Delta function Messages <p>Return Lock</p>	<p>TC process medium</p> <p>You can choose from:</p> <ul style="list-style-type: none"> • Linear (input of TC coefficient) • Ultrapure water • Table: <p>When measuring media with a known temperature response, the output pH value can be corrected using a table. TC can be entered in 5°C steps for temperatures between 0 and +95°C. Then, the output pH value is corrected by the corresponding TC value depending on the measuring temperature. Intermediate values are linearly interpolated.</p>										
	 <p> <input type="checkbox"/> 7.00 pH <input type="checkbox"/> 24.0 °C <input type="checkbox"/> TC process medium (Administrator) </p> <p>TC</p> <ul style="list-style-type: none"> Off Linear Ultrapure water Table <p>Return OK</p>	<p>In the case of lower or higher temperatures (< 0°C or >+95°C), the last table value is used for calculation. If the delta function has been activated (see next page) simultaneously with temperature compensation, the temperature is compensated first and then the delta value is subtracted.</p>										
	 <p> <input type="checkbox"/> 7.00 pH <input type="checkbox"/> 24.0 °C <input type="checkbox"/> TC process medium (Administrator) </p> <p>TC Table</p> <table border="0"> <tr><td>TC at 00°C:</td><td>+00.00%</td></tr> <tr><td>TC at 05°C:</td><td>+00.00%</td></tr> <tr><td>TC at 10°C:</td><td>+00.00%</td></tr> <tr><td>TC at 15°C:</td><td>+00.00%</td></tr> <tr><td>TC at 20°C:</td><td>+00.00%</td></tr> </table> <p>Abort Info</p>	TC at 00°C:	+00.00%	TC at 05°C:	+00.00%	TC at 10°C:	+00.00%	TC at 15°C:	+00.00%	TC at 20°C:	+00.00%	<p>If the delta function has been activated (see next page) simultaneously with temperature compensation, the temperature is compensated first and then the delta value is subtracted.</p>
TC at 00°C:	+00.00%											
TC at 05°C:	+00.00%											
TC at 10°C:	+00.00%											
TC at 15°C:	+00.00%											
TC at 20°C:	+00.00%											
	 <p> <input type="checkbox"/> 7.00 TC pH <input type="checkbox"/> 24.0 °C </p> <p> <input type="checkbox"/> Outp I1 5.70 mA <input type="checkbox"/> Favorites menu </p>	<p>When the TC correction for process medium is switched on, "TC" appears in the display in measuring mode.</p>										

Parameter Setting (Memosens PH)

TC process medium, delta function

Note: HOLD mode active

Temperature compensation of process medium

Linear temperature compensation, reference temp fixed at 25 °C

$$\text{pH}_{(25\text{ }^\circ\text{C})} = \text{pH}_M + \text{TC}/100 \% (25\text{ }^\circ\text{C} - T_M)$$

$$\text{pH}_{(25\text{ }^\circ\text{C})} = \text{pH value compensated to } 25\text{ }^\circ\text{C}$$

$$\text{pH}_M = \text{Measured pH value (temperature-corrected)}$$

$$\text{TC} = \text{Temperature factor } [\%/K]$$



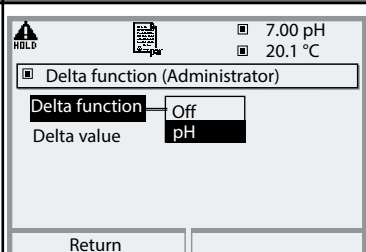
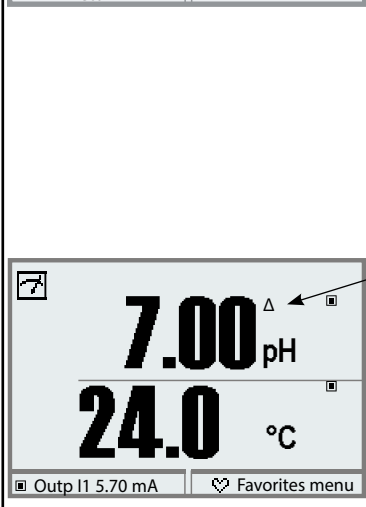

$$T_M = \text{Measured temperature } [^\circ\text{C}]$$

Menu	Display	Delta function
		<p>Delta function</p> <p>When a delta value is entered, the system calculates the difference</p> <p>Output value = measured value – delta value</p> <p>The output value controls all outputs and is shown on the display. When the delta function has been activated simultaneously with temperature compensation, the temperature is compensated first and then the delta value is subtracted.</p> <p>When delta function is switched on, “Δ” appears in the display in measuring mode.</p>

Parameter Setting (Memosens PH)

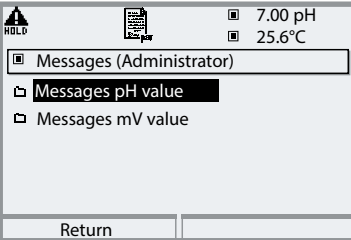
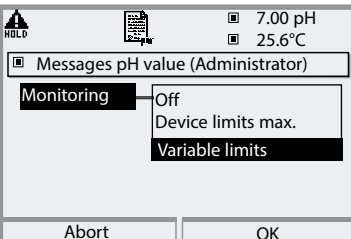
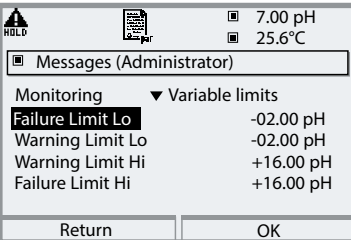
Messages

Note: HOLD mode active

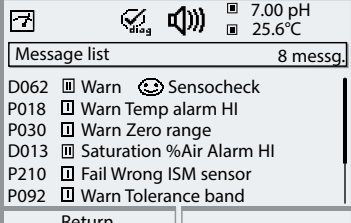
Menu	Display	Messages
	  	<p>Messages</p> <p>All parameters determined by the measuring module can generate messages.</p> <p>Device limits max.: Messages are generated when the process variable (e.g. pH) is outside the measuring range. The “Failure” icon is displayed, the NAMUR failure contact is activated (BASE module, factory setting: contact K4, N/C contact). The current outputs can signal a 22mA message (user defined).</p> <p>Variable limits: For the “failure” and “warning” messages, you can define upper and lower limits for message generation.</p> <p>Message icons</p> <ul style="list-style-type: none">  Failure (Failure limit HiHi/LoLo)  Maintenance (Warning limit Hi/Lo)  Limit indication (here: lower range)
		<p>Diagnostics menu</p> <p>When the “Maintenance” or “Failure” icons are blinking in the display, you should access the Diagnostics menu. The messages are displayed in the “Message list”.</p>

Memosens PH Calibration / Adjustment

Note: HOLD mode active for the currently calibrated module
Current outputs and relay contacts behave as configured

The calibration data are stored in the sensor. This allows calibrating, adjusting, regenerating or cleaning the sensors in a lab, far from the point of measurement. On the site, you simply replace the used sensors by calibrated sensors.

- **Calibration:** Detecting deviations without readjustment
- **Adjustment:** Detecting deviations with readjustment

NOTICE:

Without adjustment every pH meter delivers an imprecise or wrong output value! Every pH electrode has its individual zero point and its individual slope. Both values are altered by aging and wear.

To determine the correct pH value, the pH meter must be adjusted to the electrode. The analyzer corrects the voltage delivered by the electrode with regard to electrode zero and slope and displays it as the pH value.

Be sure to perform an adjustment after having replaced the electrode!

Procedure

First, a calibration is performed to detect the deviations of the electrode (zero, slope). To do so, the electrode is immersed in buffer solutions whose pH value is exactly known. The measuring module measures the electrode voltages and the buffer solution temperature and automatically calculates the electrode zero and slope. These data are stored in a calibration record. By "Adjustment" the determined calibration data can be used for correction (see following page).

Parameters determined by calibration

Zero point is the pH value at which the pH electrode outputs the voltage 0 mV. It is different for each electrode and changes with age and wear.

Temperature of the process solution must be detected since pH measurement is temperature-dependent. Many electrodes have an integrated temperature probe.

Slope of an electrode is the voltage change per pH unit. For an ideal pH electrode, it lies at -59.2 mV/pH.

Adjustment (Memosens PH)

Adjustment means that the values determined by a calibration are taken over and saved in the sensor. The values determined for zero and slope are entered in the calibration record. (Diagnostics / Module FIU 3400X-140 / Memosens PH / Cal record). These values are only effective for calculating the measured variables when the calibration has been terminated with an adjustment. A passcode ensures that an adjustment can only be performed by an authorized person (Administrator).

The Operator can check the current sensor data by a calibration and inform the Administrator when there are deviations. You can use the additional function SW 3400-107 for granting access rights (passcodes) and for "Audit Trail" (continuous data recording and backup according to FDA 21 CFR Part 11).

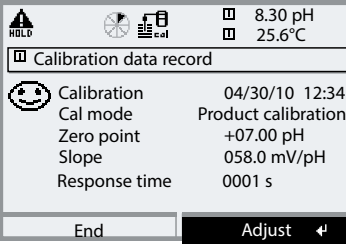
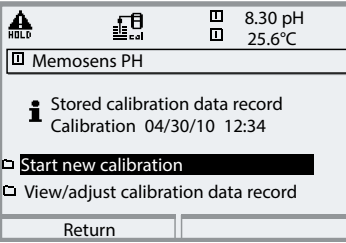
Menu	Display	Adjustment after calibration
		<p>Administrator</p> <p>With the corresponding access rights, the device can immediately be adjusted after calibration. The calibration values are taken over for calculating the measured variables.</p>
		<p>Operator (without administrator rights)</p> <p>After calibration, change to measuring mode. Inform Administrator. When opening the menu (Calibration, respective module), the Administrator sees all data of the last calibration and can take over the values or perform a new calibration.</p>

Calibration / Adjustment (Memosens PH)

Calibration Methods



With Memosens sensors, the calibration data are stored in the sensor.

This allows using precalibrated sensors.

When the Protos is used for precalibrating sensors in the lab, for example, you can use the calibration routines described below.

One-point calibration

The electrode is calibrated with one buffer solution only.

Here, only the electrode zero point is detected and taken into account by the Protos. One-point calibration is appropriate and permissible whenever the measured values lie near the electrode zero point so that slope changes do not have much of an impact.

Two-point calibration

The electrode is calibrated with two buffer solutions.

In that case, zero point and slope of the electrode can be detected and taken into account by the Protos. Two-point calibration is required if

- the measured pH values cover a wide range
- there is great difference between the measured pH value and the electrode zero
- the pH measurement must be very accurate
- the electrode is exposed to extreme wear.

Three-point calibration

The electrode is calibrated with three buffer solutions.

Zero and slope are calculated using a line of best fit according to DIN 19268.

Calibration / Adjustment (Memosens PH)

Temperature compensation

Temperature compensation during calibration

There are two important reasons for determining the temperature of the buffer solution:

The slope of the pH electrode is temperature-dependent. Therefore the measured voltage must be corrected by the temperature influence.

The pH value of the buffer solution is temperature-dependent. For calibration, the buffer solution temperature must therefore be known in order to choose the actual pH value from the buffer table.

Automatic temperature compensation

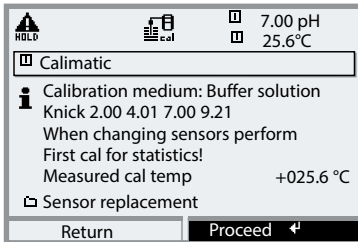



Protos measures the temperature of the buffer solution using the temperature detector integrated in the Memosens sensor.

HOLD Function During Calibration

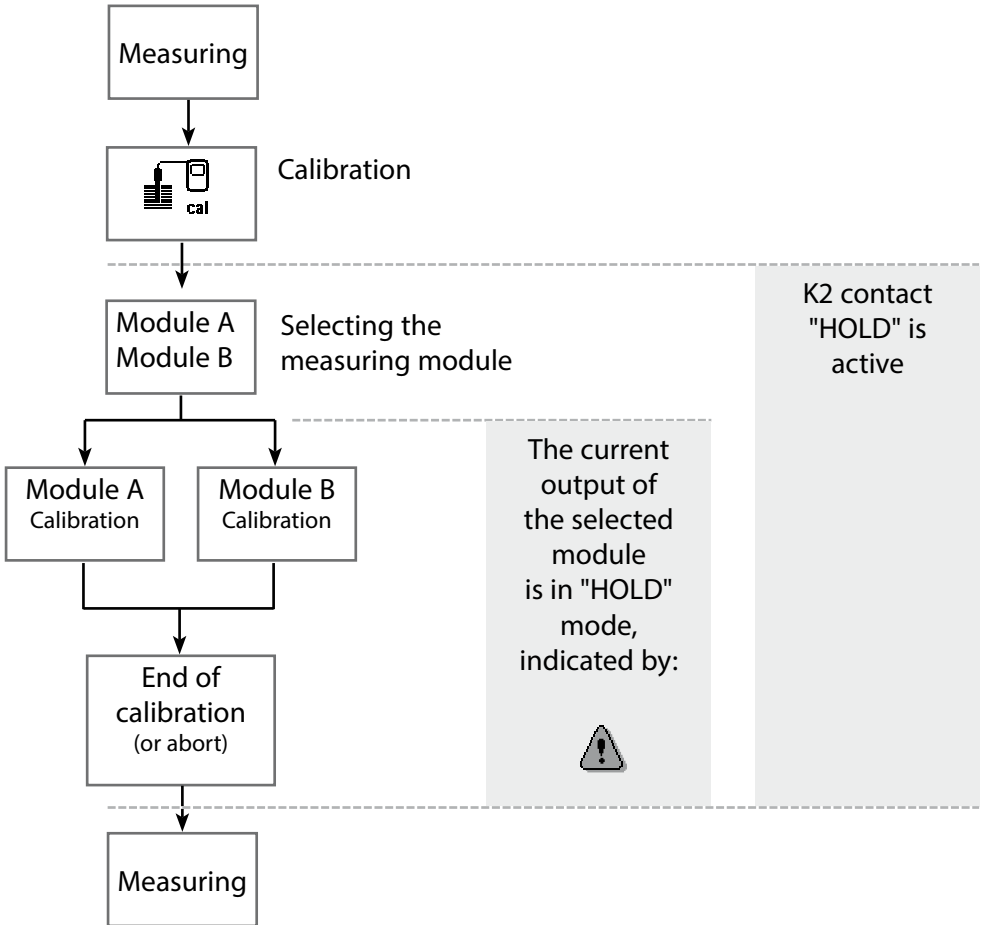
Behavior of the signal and relay outputs during calibration

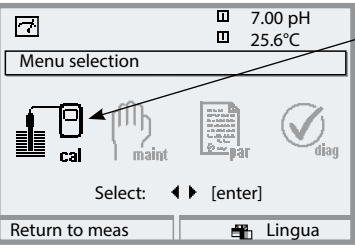

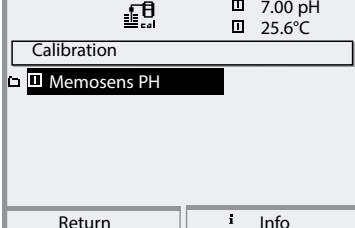
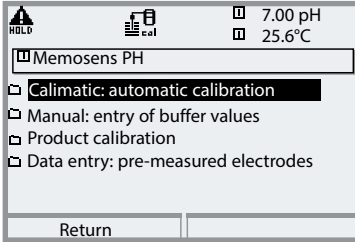
Menu	Display	Select calibration method (pH)
		<p>Open calibration Press menu key to select menu. Select calibration using arrow keys, press enter to confirm, passcode 1147 (To change passcode, select: Parameter setting/System control/Passcode entry).</p>
		<p>Calibration: Select "Memosens PH"</p>
		<p>Select calibration method:</p> <ul style="list-style-type: none"> • Automatic buffer recognition (Calimatic) • Manual entry of buffer values • Product calibration (calibration with sampling) • Entry of previously measured electrode data • ISFET zero adjustment (for ISFET only) <p>When you access calibration, the analyzer automatically proposes the previous calibration method. If you do not want to calibrate, "Return" with the left softkey.</p> <p>During calibration the module is in HOLD mode. Current outputs and relay contacts of the module behave as configured (BASE module).</p>

Calibration / Adjustment (Memosens PH)

Calimatic Automatic Buffer Recognition

Automatic buffer recognition (Calimatic)

Automatic calibration using Knick Calimatic is performed with one, two, or three buffer solutions. Protos automatically detects the nominal buffer value on the basis of the electrode potential and the measured temperature. Any sequence of buffer solutions is possible, but they must belong to the buffer set defined during parameter setting.

The Calimatic takes the temperature dependence of the buffer value into account. All calibration data is converted using a reference temperature of 25 °C.

During calibration the module is in HOLD mode.

Current outputs and relay contacts of the module behave as configured (Module BASE).

NOTICE!

Only ever use fresh, undiluted buffer solutions which belong to the selected buffer set!

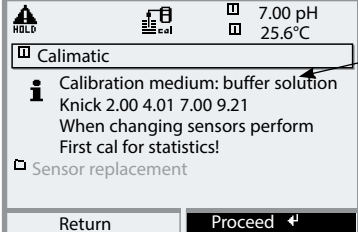
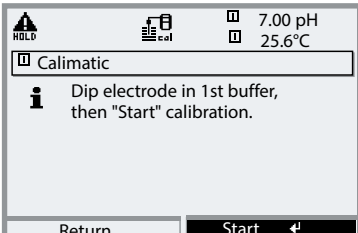
Menu	Display	Automatic buffer recognition
	 <p>The screenshot shows the 'Calimatic' menu in HOLD mode. At the top, it displays '7.00 pH' and '25.6°C'. Below the title, there is an information icon and text: 'Calibration medium: buffer solution', 'Knick 2.00 4.01 7.00 9.21', 'When changing sensors perform First cal for statistics!', and 'Sensor replacement'. At the bottom, there are 'Return' and 'Proceed' softkeys.</p>	Select: Calimatic Display of selected buffer set Proceed by pressing softkey or enter .
	 <p>The screenshot shows the 'Calimatic' menu in HOLD mode. At the top, it displays '7.00 pH' and '25.6°C'. Below the title, there is an information icon and text: 'Dip electrode in 1st buffer, then "Start" calibration.'. At the bottom, there are 'Return' and 'Start' softkeys.</p>	Remove and rinse the electrode (NOTICE: Do not rub! Electrostatic hazard!), then immerse it in the first buffer solution. Start by pressing softkey or enter .

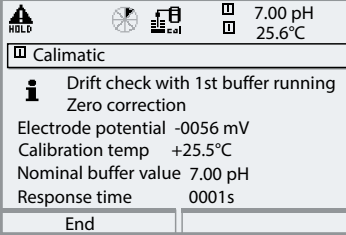
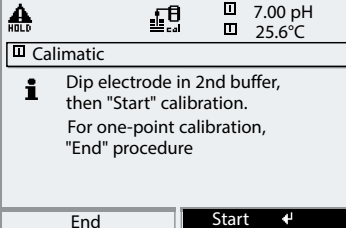
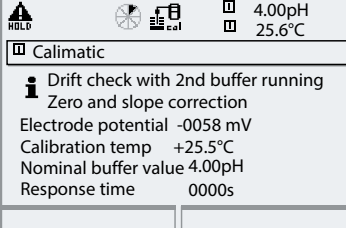
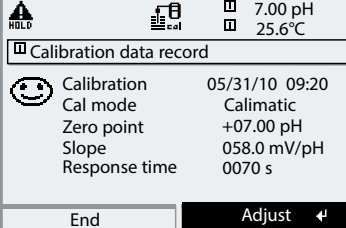
Menu	Display	Automatic buffer recognition
	 <p>Calimatic</p> <p>Drift check with 1st buffer running Zero correction</p> <p>Electrode potential -0056 mV Calibration temp +25.5°C Nominal buffer value 7.00 pH Response time 0001s</p> <p>End</p>	<p>Display of nominal buffer value. You can press "End" to reduce the waiting time before stabilization of the electrode potential (reduced accuracy of calibration values).</p> <p>From the response time, you see how much time the electrode needs for the potential to stabilize. If the electrode potential or the measured temperature fluctuate greatly, the calibration procedure is aborted after 2 min.</p>
	 <p>Calimatic</p> <p>Dip electrode in 2nd buffer, then "Start" calibration. For one-point calibration, "End" procedure</p> <p>End Start ↵</p>	<p>For a one-point calibration, press "End" softkey.</p> <p>For two-point calibration: Rinse electrode thoroughly! Immerse electrode in the second buffer solution.</p> <p>Start by pressing softkey or enter.</p>
	 <p>Calimatic</p> <p>Drift check with 2nd buffer running Zero and slope correction</p> <p>Electrode potential -0058 mV Calibration temp +25.5°C Nominal buffer value 4.00pH Response time 0000s</p>	<p>Calibration is performed with the second buffer.</p> <p>Three-point calibration is performed correspondingly with the third buffer.</p>
	 <p>Calibration data record</p> <p>☺ Calibration 05/31/10 09:20 Cal mode Calimatic Zero point +07.00 pH Slope 058.0 mV/pH Response time 0070 s</p> <p>End Adjust ↵</p>	<p>Adjustment</p> <p>Press "Adjust" to take over the values determined during calibration for calculating the measured variables and to save them in the sensor.</p>

Calibration / Adjustment (Memosens PH)

Calibration with Manual Entry of Buffer Values

Calibration with manual entry of buffer values

Calibration with manual entry of buffer values is performed with one, two or three buffer solutions.

Protos displays the measured temperature.

You must then enter the temperature-corrected buffer values. To do so, refer to the buffer table (e.g. on the bottle) and enter the buffer value belonging to the displayed temperature.

Intermediate values must be interpolated.

All calibration data is converted using a reference temperature of 25 °C.









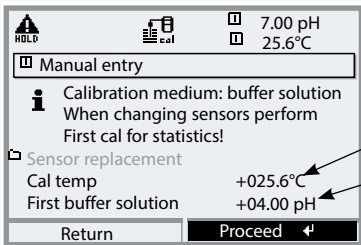
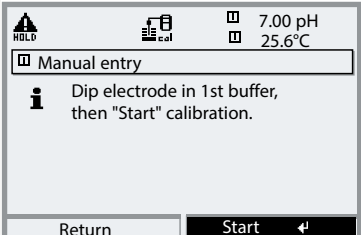

















During calibration the module is in HOLD mode.

Current outputs and relay contacts of the module behave as configured (Module BASE).

NOTICE!

Only ever use fresh, undiluted buffer solutions!

Menu	Display	Manual entry
 cal	 <p>Display: Cal temp Enter first buffer value Proceed by pressing softkey or enter</p>	Select: Manual entry
	 <p>Remove and rinse the electrode (NOTICE: Do not rub! Electrostatic hazard!), then immerse it in the first buffer solution. Start by pressing softkey or enter</p>	

Menu	Display	Manual entry
  cal	     4.00pH 25.6°C <hr/> Manual entry  Drift check with 1st buffer running. Zero correction Electrode potential -0224 mV Calibration temp +25.6°C Nominal buffer value +04.00 pH Response time 0018s <hr/> End	<p>Calibration with first buffer solution. You can press “End” to reduce the waiting time before stabilization of the electrode potential (reduced accuracy of calibration values).</p> <p>From the response time, you see how much time the electrode needs for the potential to stabilize. If the electrode potential or the measured temperature fluctuate greatly, the calibration procedure is aborted after 2 min.</p>
	    7.00 pH 25.6°C <hr/> Manual entry  Dip electrode in 2nd buffer, then “Start” calibration. For one-point calibration, ‘End’ procedure <hr/> Second buffer solution +07.00 pH <hr/> End Start 	<p>One-point calibration: “End”.</p> <p>Two-point calibration: Rinse electrode thoroughly! Enter 2nd buffer value for correct temperature. Immerse electrode in the second buffer solution. Start by pressing softkey or enter</p>
	     7.00 pH 25.6°C <hr/> Manual entry  Drift check with 2nd buffer running Zero and slope correction Electrode potential -0000 mV Calibration temp +25.6°C Nominal buffer value +07.00 pH Response time 0007s <hr/> End	<p>Calibration is performed with the second buffer.</p> <p>Three-point calibration is performed correspondingly with the third buffer.</p>
	    7.00 pH 25.6°C <hr/> Calibration data record  Calibration 05/31/10 09:20 Cal mode Manual input Zero point +07.00 pH Slope 058.0 mV/pH Response time 0070 s <hr/> End Adjust 	<p>Adjustment</p> <p>Press “Adjust” to take over the values determined during calibration for calculating the measured variables to save them in the sensor.</p>

Calibration / Adjustment (Memosens PH)

Product Calibration

Product calibration (calibration with sampling)

When the electrode cannot be removed – e.g. for sterility reasons – its zero point can be determined with “sampling”. To do so, the currently measured process value is stored by the Protos. Immediately afterwards, you take a sample from the process. The pH value of the sample is measured in the lab or directly on the site using a portable pH meter. The reference value is entered into the measuring system. From the difference between measured value and reference value, the Protos calculates the electrode zero point (this method only allows one-point calibration).

During calibration the module is in HOLD mode. Current outputs and relay contacts of the module behave as configured (BASE).

NOTICE! The pH value of the sample is temperature-dependent. Therefore, the reference measurement should be performed at the sample temperature shown in the display. Transport the sample in an insulated container. The pH value may also be altered due to escaping of volatile substances.

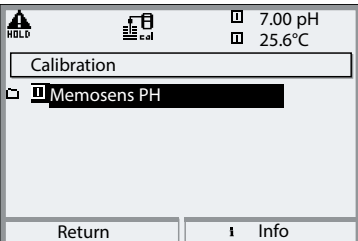
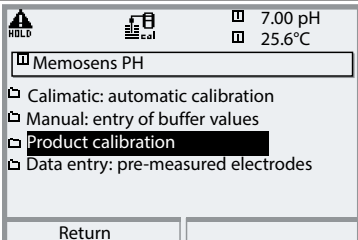
Menu	Display	Product calibration
		<p>Memosens PH</p> <p>The module is in HOLD mode. The assigned current outputs and relay contacts behave as configured (BASE). Press enter to confirm.</p>
		<p>Select calibration mode "Product calibration"</p> <p>Press enter to confirm.</p>

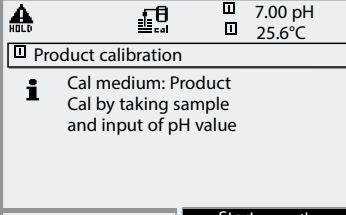
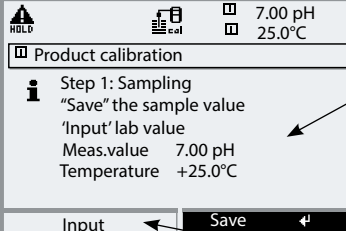
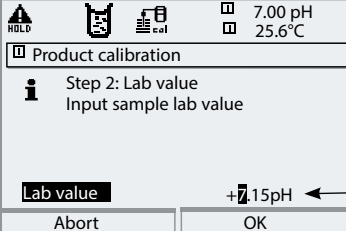
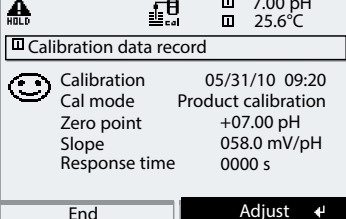
Menu	Display	Product calibration
		<p>The module is in HOLD mode.</p> <p>Product calibration Product calibration is performed in 2 steps. Prepare sampling, start by pressing softkey or enter.</p>
		<p>Step 1 Take sample. Save measured value and temperature at the moment of sampling ("Save" softkey or enter). Press meas to return to measurement.</p> <p>Exception: Sample value can be measured on the site and be entered immediately. To do so, press "Input" softkey.</p>
		<p>Step 2 Lab value has been measured. When you open the Product calibration menu again, the display shown on the left appears: Enter reference value ("Lab value"). Confirm with OK or repeat calibration.</p>
		<p>Adjustment Press "Adjust" to take over the values determined during calibration for calculating the measured variables to save them in the sensor.</p>

Calibration / Adjustment (Memosens PH)

Calibration by Entering Data from Premeasured Electrodes

Data entry of premeasured electrodes

Entry of values for zero point and slope of a pH electrode. The values must be known, e.g. determined beforehand in the laboratory.

During calibration the module is in HOLD mode. Current outputs and relay contacts of the module behave as configured (BASE).

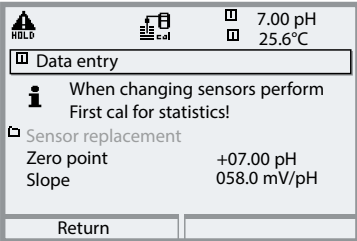
Menu	Display	Manual entry
		<p>Select: Data entry of premeasured electrodes</p> <p>Remove electrode and connect pre-measured electrode.</p> <p>Enter the values for</p> <ul style="list-style-type: none">• Zero point• Slope <p>Return using softkey or press meas to return to measurement.</p>

Calibration / Adjustment (Memosens PH)

Monitoring functions for calibration

Protos provides comprehensive functions for monitoring proper calibration performance and the electrode condition. This allows documentation for quality management to ISO 9000 and GLP/GMP.

- Sensocheck monitors the electrode condition by measuring the glass electrode impedance.
- Regular calibration can be monitored by the cal timer.
- Adaptive cal timer - automatically reduces the calibration interval when the electrode is subjected to high stress
- The calibration record (GLP/GMP) provides all relevant data of the last calibration and adjustment.
- The logbook shows the time and date of a performed calibration.

Memosens PH Maintenance

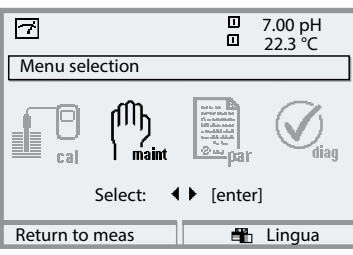
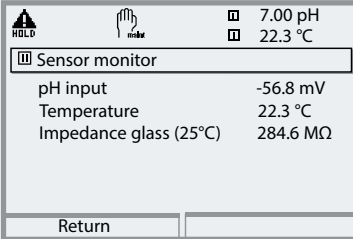
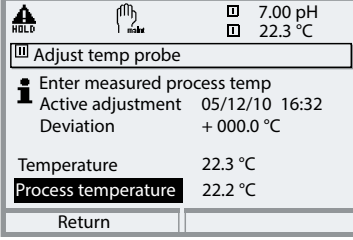

Sensor monitor, temp probe adjustment

Note: HOLD mode active

Menu	Display	Maintenance
	  	<p>Opening the maintenance menu</p> <p>From the measuring mode: Press menu key to select menu. Select maintenance using arrow keys, confirm by pressing enter. Passcode (as delivered): 2958 Then select Module FIU 3400-141 and the corresponding Memosens PH sensor.</p> <p>Sensor Monitor</p> <p>For validation of sensor and complete signal processing.</p> <p>Temp Probe Adjustment</p> <p>This function allows compensating for the individual temperature probe tolerance and the influence of the lead resistances to increase the accuracy of temperature measurement. The adjust- ment value is stored in the sensor. Before performing an adjustment, you must precisely measure the process temperature using a calibrated refer- ence thermometer. The measurement error of the reference thermometer should be less than 0.1 °C. Adjustment without precise measurement might result in considerable deviations of the measured value display!</p>

Memosens PH Diagnostics

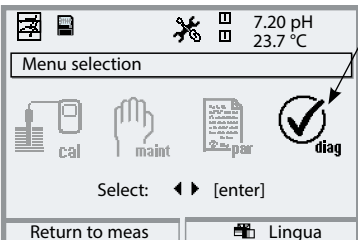
General status information of the measuring system
 Select menu: Diagnostics

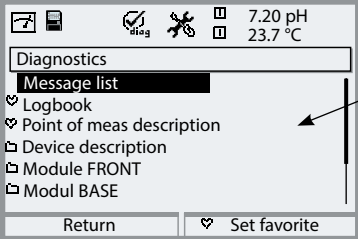
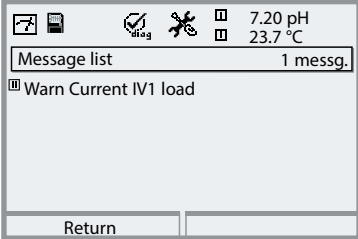
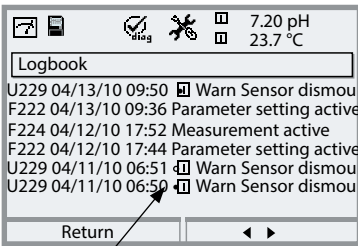
Menu	Display	Diagnostics functions
		<p>Opening the diagnostics menu</p> <p>From the measuring mode: Press menu key to select menu. Select diagnostics using arrow keys, confirm by pressing enter.</p>
		<p>The “Diagnostics” menu gives an overview of all functions available. Functions which have been set as “Favorite” can be directly accessed from the measuring mode.</p>
		<p>Message List</p> <p>Shows the currently activated warning or failure messages in plain text.</p>
	 <p>Module concerned:</p> <ul style="list-style-type: none"> • Message activated ◦ Message deactivated 	<p>Logbook</p> <p>Shows the last 50 events with date and time, e.g. calibrations, warning and failure messages, power failure etc. This permits quality management documentation to ISO 9000 et seq. Extended logbook: SmartMedia card (SW 3400-104)</p>

Diagnostics (Memosens PH)

Sensor monitor, cal record

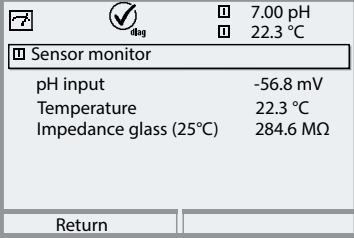
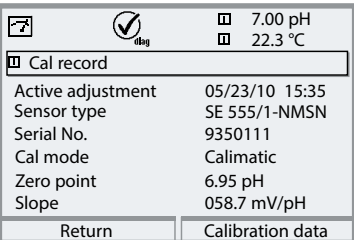
Menu	Display	Sensor monitor, cal record
	 <p>The screenshot shows the 'Sensor monitor' menu. At the top, there are three status indicators: a list icon, a checked 'diag' icon, and two values: 7.00 pH and 22.3 °C. Below this is a title bar 'Sensor monitor' and a list of three items: 'pH input' with value '-56.8 mV', 'Temperature' with value '22.3 °C', and 'Impedance glass (25°C)' with value '284.6 MΩ'. At the bottom, there is a 'Return' button.</p>	<p>Sensor Monitor Shows the values currently measured by the sensor. Important function for diagnostics and validation.</p>
	 <p>The screenshot shows the 'Cal record' menu. At the top, there are three status indicators: a list icon, a checked 'diag' icon, and two values: 7.00 pH and 22.3 °C. Below this is a title bar 'Cal record' and a list of six items: 'Active adjustment' (05/23/10 15:35), 'Sensor type' (SE 555/1-NMSN), 'Serial No.' (9350111), 'Cal mode' (Calimatic), 'Zero point' (6.95 pH), and 'Slope' (058.7 mV/pH). At the bottom, there are two buttons: 'Return' and 'Calibration data'.</p>	<p>Cal Record Data of last adjustment/calibration, suitable for documentation to ISO 9000 and GLP/GMP (Date, time, calibration method, zero and slope, iso-thermal potential, information concerning calibration buffers and response times)</p>

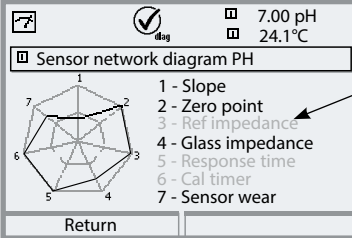
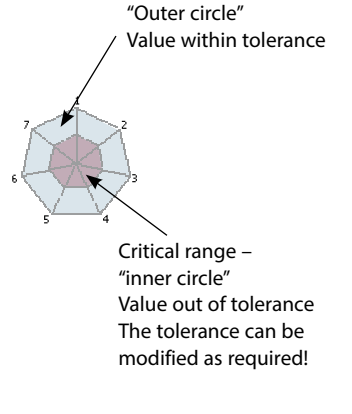
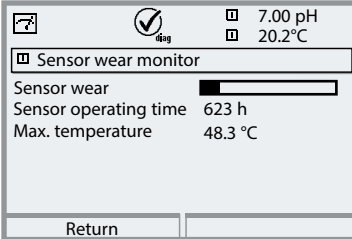

Diagnostics (Memosens PH)

Sensor network diagram PH, sensor wear monitor

Menu	Display	Sensor network diagram PH, sensor wear
 diag	<div data-bbox="179 375 532 614">  </div> <div data-bbox="179 678 532 1093">  </div>	<h3>Sensor Network Diagram</h3> <p>Graphical representation of the sensor parameters. Tolerance limit violations can be seen at a glance. Critical parameters are blinking. Parameters displayed in gray have been disabled during parameter setting or do not apply to the currently selected sensor.</p> <p>The tolerance limits (radius of "inner circle") can be modified as desired. See Parameter setting / Sensor data / Sensor monitoring details.</p>
	<div data-bbox="179 1117 532 1356">  </div>	<h3>Sensor Wear Monitor</h3> <p>Display of sensor operating time and max. temperature during the operating time, graphical representation of sensor wear related to theoretical max. operating time.</p>

Diagnostics (Memosens PH)

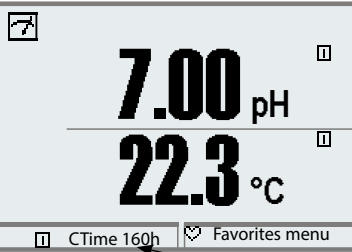
Cal timer, adaptive cal timer, tolerance adjustment

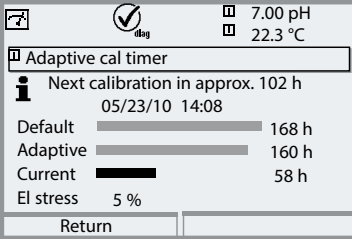
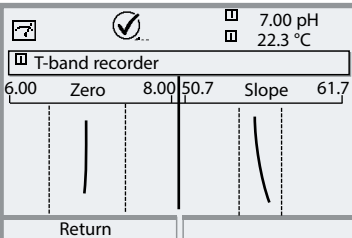
Menu	Display	Cal timer, tolerance band recorder
		<p>Calibration Timer</p> <p>After expiration of a presettable interval (Parameter setting, Memosens PH, Cal preset values), the calibration timer generates a warning message as a reminder that calibration is required. The remaining time can be indicated in the measuring mode by pressing a softkey (secondary display: "CTime").</p>
		<p>Adaptive Calibration Timer</p> <p>The time until the next due calibration is automatically reduced depending on the temperature, pH value and sensor wear.</p>
		<p>Tolerance Adjustment</p> <p>Additional function SW 3400-005</p> <p>Records the tolerance ranges for zero and slope over the time. If the values determined by a calibration exceed the tolerance limits, the calibration is taken over as adjustment.</p> <p>Display can be graphical or as a listing. The tolerance band (zero, slope) is configured during parameter setting (Memosens PH, Cal preset values).</p>

Memosens ORP Parameter Setting

Select mode and process variable (ORP).

Note: "HOLD" mode active

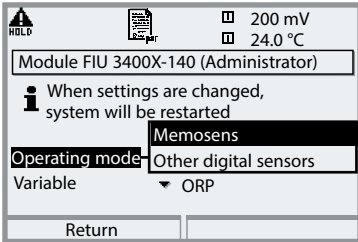
Menu	Display	Parameter setting
		<p>Select mode and process variable. Select: Parameter setting/ Module FIU 3400-141/ Operating mode Memosens, Variable: ORP. When the operating mode or the process variable is changed (or selected for the first time), the analyzer automatically restarts to re-initialize the system.</p>

After restart, a connected Memosens sensor is displayed immediately:

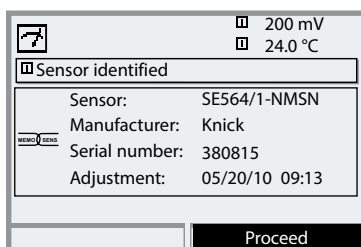

All sensor-typical parameters are automatically sent to the analyzer.

These are, for example, the measuring range, zero and slope of the sensor. Without any further parameter setting, measurement starts at once, the measuring temperature is simultaneously detected.

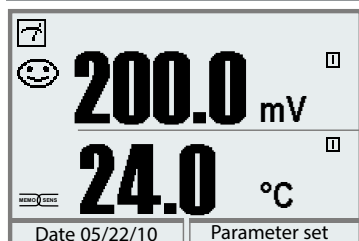

With "Plug&Measure", premeasured Memosens sensors can immediately be used for measurement without previous calibration.

The Memosens icon is displayed as long as a Memosens sensor is connected.

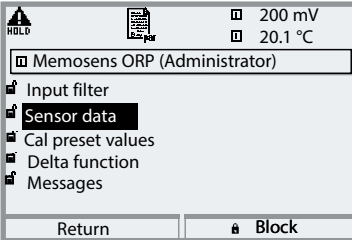
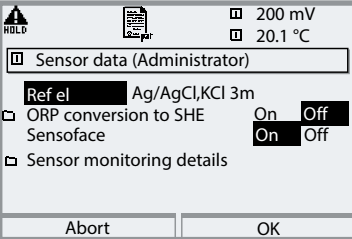
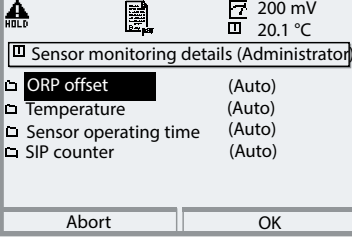

Parameter Setting (Memosens ORP)

Note: HOLD mode active

Menu	Display	Parameter selection
	 <p> <input type="checkbox"/> 200 mV <input type="checkbox"/> 20.1 °C <input type="checkbox"/> Memosens ORP (Administrator) </p> <ul style="list-style-type: none"> Input filter Sensor data Cal preset values Delta function Messages <p>Return Block</p>	<p>Sensor data</p> <p>Memosens sensors provide most of the parameters automatically.</p> <p>Sensoface provides information on the sensor condition (evaluating the sensor data).</p>
	 <p> <input type="checkbox"/> 200 mV <input type="checkbox"/> 20.1 °C <input type="checkbox"/> Sensor data (Administrator) </p> <p>Ref el <input type="checkbox"/> Ag/AgCl,KCl 3m</p> <ul style="list-style-type: none"> ORP conversion to SHE <input type="checkbox"/> On <input type="checkbox"/> Off Sensoface <input type="checkbox"/> On <input type="checkbox"/> Off Sensor monitoring details <p>Abort OK</p>	<p>Sensor monitoring details</p> <p>If the entries are "(Auto)" data, they can be displayed but not edited. The values are displayed in gray.</p>
	 <p> <input type="checkbox"/> 200 mV <input type="checkbox"/> 20.1 °C <input type="checkbox"/> Sensor monitoring details (Administrator) </p> <ul style="list-style-type: none"> ORP offset (Auto) Temperature (Auto) Sensor operating time (Auto) SIP counter (Auto) <p>Abort OK</p>	<p>Messages</p> <p>Limit violations can be signaled by a message (either "failure" or "maintenance request"). The tolerance limits are stored in the sensor. They are displayed in gray.</p>
	 <p> <input type="checkbox"/> 200 mV <input type="checkbox"/> 20.1 °C <input type="checkbox"/> Message ORP offset (Administrator) </p> <p>Monitoring ▼ Auto</p> <p>Nominal +0000 mV</p> <p>Min -0200 mV</p> <p>Max +0200 mV</p> <p>Message Maint. request</p> <p>Abort OK</p>	

Parameter Setting (Memosens ORP)

Parameter	Default	Selection / Range
Input filter		
Pulse suppression	Off	On, Off
Sensor data		
Sensoface	On	On, Off
Conversion to standard hydrogen electrode		
Sensor monitoring details		
Sensor parameters		SIP cycles and sensor operating time
Cal preset values		
Cal timer monitoring	Auto: 0168h	Auto, Off, Individual
ORP check	Test period 10 s Test difference 10 mV	Off, On
Delta function		
Delta function	Off	Off, ORP
Messages		
Messages ORP value	Off	Off, Variable limits

Parameter Setting (Memosens ORP)

Delta function



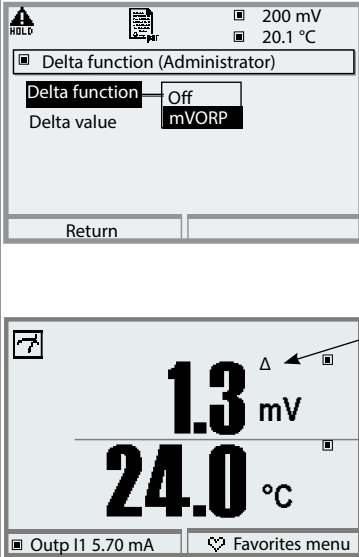

Note: HOLD mode active

Menu	Display	Delta function
	 <p>The top screenshot shows the 'Delta function (Administrator)' menu with 'Delta function' set to 'Off' and 'Delta value' set to 'mVORP'. The bottom screenshot shows the main display with '1.3 mV' and '24.0 °C' readings, and a small 'Δ' symbol next to the mV reading. A red arrow points to the 'Δ' symbol.</p>	<p>Delta function</p> <p>When a delta value is entered, the system calculates the difference</p> <p>Output value = measured value – delta value</p> <p>The output value controls all outputs and is shown on the display. When delta function is switched on, "Δ" appears in the display in measuring mode.</p>

Parameter Setting (Memosens ORP)

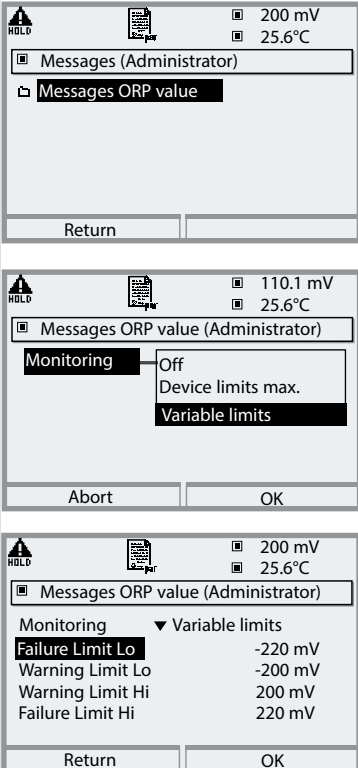
Messages

Note: HOLD mode active

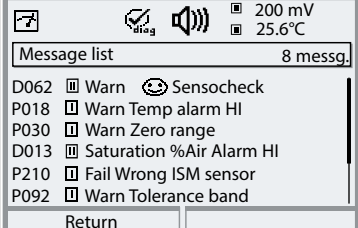
Menu	Display	Messages
	 <p>The screenshot shows three stages of the 'Messages' menu. The top stage shows 'Messages (Administrator)' with 'Messages ORP value' selected. The middle stage shows 'Monitoring' set to 'Off' and 'Variable limits' selected. The bottom stage shows a list of limits: Failure Limit Lo (-220 mV), Warning Limit Lo (-200 mV), Warning Limit Hi (200 mV), and Failure Limit Hi (220 mV).</p>	<p>Messages</p> <p>All parameters determined by the measuring module can generate messages.</p> <p>Device limits max.:</p> <p>Messages are generated when the process variable (e.g. mV) is outside the measuring range. The “Failure” icon is displayed, the NAMUR failure contact is activated (BASE module, factory setting: contact K4, N/C contact). The current outputs can signal a 22mA message (user defined).</p> <p>Variable limits:</p> <p>For the “failure” and “warning” messages, you can define upper and lower limits for message generation.</p> <p>Message icons</p> <ul style="list-style-type: none">  Failure (Failure limit HiHi/LoLo)  Maintenance (Warning limit Hi/Lo)  Limit indication (here: lower range)
	 <p>The screenshot shows the 'Message list' with 8 messages. The list includes: D062 Warn Sensocheck, P018 Warn Temp alarm HI, P030 Warn Zero range, D013 Saturation %Air Alarm HI, P210 Fail Wrong ISM sensor, and P092 Warn Tolerance band.</p>	<p>Diagnostics menu</p> <p>When the “Maintenance” or “Failure” icons are blinking in the display, you should access the Diagnostics menu. The messages are displayed in the “Message list”.</p>

Memosens ORP Calibration / Adjustment

ORP calibration/adjustment

ORP calibration/adjustment

The potential of a redox electrode is calibrated using a redox (ORP) buffer solution. In the course of that, the difference between the measured potential and the potential of the calibration solution is determined. This potential difference is printed on the calibration solution bottle and is defined as the voltage across the redox electrode and a reference electrode. The voltage value is stored in the Memosens sensor.

Examples: 220 mV Pt against Ag/AgCl, KCl 3 mol/l
 427 mV Pt against SHE

During measurement this difference is added to the measured potential.

$$mV_{\text{ORP}} = mV_{\text{meas}} + \Delta mV$$

mV_{ORP} = displayed oxidation-reduction potential (measured ORP)

mV_{meas} = direct electrode potential (ORP input, see Sensor monitor)

ΔmV = delta value, determined during calibration

ORP related to the standard hydrogen electrode (SHE)

The oxidation-reduction potential can also be calibrated automatically with respect to the standard hydrogen electrode (SHE).

The temperature behavior of the reference electrode is automatically taken into account.

Reference electrode:

Ag/AgCl, KCl 3 mol/l (silver/silver chloride)

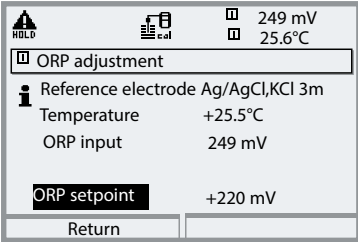
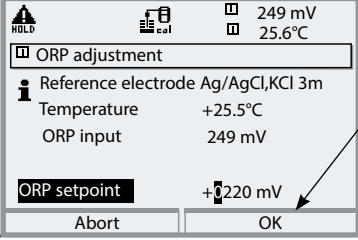
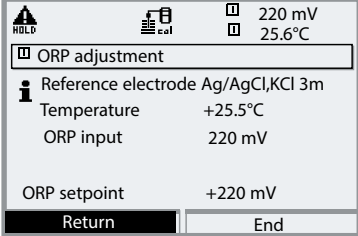
Menu	Display	ORP adjustment
		<p>The module is in HOLD mode!</p> <p>Immerse electrode in calibration medium and wait until the ORP value has stabilized.</p> <p>Enter the nominal ORP value (bottle).</p>
		<p>Be sure to observe the correct reference reference (as configured) Press "OK" to confirm.</p>
		<p>End adjustment by pressing softkey or enter.</p> <p>The ORP value is saved in the Memosens sensor.</p>

Temperature dependence measured against SHE (standard hydrogen electrode)

Temperature [°C]	Ag/AgCl/KCl 3 mol/l [ΔmV]
0	224
10	217
20	211
25	207
30	203
40	196
50	188
60	180
70	172
80	163

Memosens ORP Maintenance

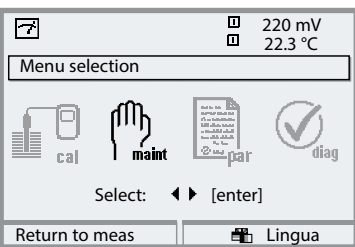
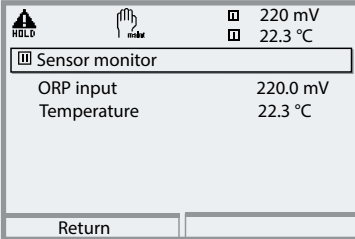
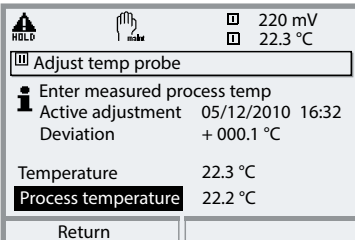

Sensor monitor / Temp probe adjustment

Note: HOLD mode active

Menu	Display	Maintenance
	  	<p>Opening the maintenance menu From the measuring mode: Press menu key to select menu. Select maintenance using arrow keys, confirm by pressing enter. Passcode (as delivered): 2958 Then select Module FIU 3400-141 and the corresponding Memosens ORP sensor.</p> <p>Sensor Monitor For validation of sensor and complete signal processing.</p> <p>Temp Probe Adjustment This function allows compensating for the individual temperature probe tolerance and the influence of the lead resistances to increase the accuracy of temperature measurement. Make sure that the process temperature is precisely measured using a calibrated reference thermometer when perform- ing an adjustment! The measurement error of the reference thermometer should be less than 0.1 °C. Adjustment without precise measurement might result in considerable deviations of the measured value display! The adjust- ment value is saved in the Memosens.</p>

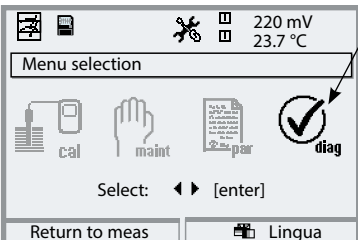

Memosens ORP Diagnostics Functions

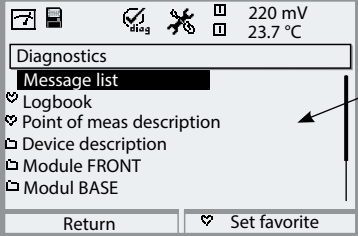
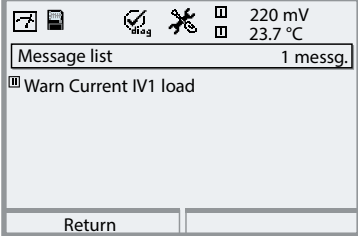
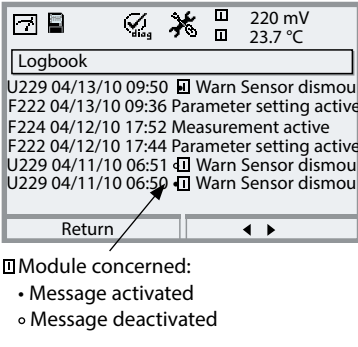
General status information of the measuring system
 Select menu: Diagnostics

Menu	Display	Diagnostics functions
		<p>Opening the diagnostics menu</p> <p>From the measuring mode: Press menu key to select menu. Select diagnostics using arrow keys, confirm by pressing enter.</p>
		<p>The “Diagnostics” menu gives an overview of all functions available. Functions which have been set as “Favorite” can be directly accessed from the measuring mode.</p>
		<p>Message List</p> <p>Shows the currently activated warning or failure messages in plain text.</p>
		<p>Logbook</p> <p>Shows the last 50 events with date and time, e.g. calibrations, warning and failure messages, power failure etc. This permits quality management documentation to ISO 9000 et seq.</p> <p>Extended logbook: SmartMedia card (SW 3400-104)</p>



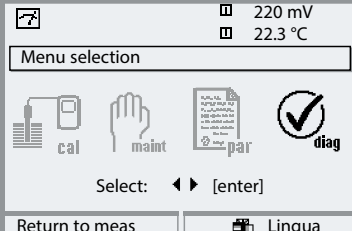

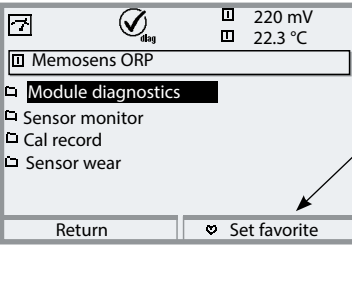
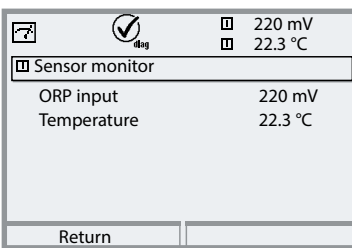

Diagnostics (Memosens ORP)

Sensor monitor

Menu	Display	Sensor monitor
		<p>Opening the diagnostics menu</p> <p>From the measuring mode: Press menu key to select menu. Select diagnostics using arrow keys, confirm by pressing enter. Then select Memosens ORP.</p>
		<p>The Diagnostics menu gives an overview of all diagnostics functions available. <u>Messages set as "Favorite"</u> can be called directly from the measuring mode using a softkey. To configure, select: Parameter setting / System control / Function control matrix.</p>
		<p>Sensor Monitor</p> <p>Shows the values currently measured by the sensor. Important function for diagnostics and validation.</p>

Diagnostics (Memosens ORP)

Cal record

Menu	Display	Cal record																											
 diag	<table border="1"><tr><td></td><td> diag</td><td><input type="checkbox"/> 220 mV <input type="checkbox"/> 22.3 °C</td></tr><tr><td colspan="3"><input type="checkbox"/> Cal record</td></tr><tr><td>Active adjustment</td><td colspan="2">05/23/10 15:35</td></tr><tr><td>Sensor model</td><td colspan="2">CPS72D-7PB21</td></tr><tr><td>Serial No.</td><td colspan="2">9350111</td></tr><tr><td>Zero offset</td><td colspan="2">136 mV</td></tr><tr><td>Redox buffer</td><td colspan="2">227 mV</td></tr><tr><td>Delta value</td><td colspan="2">1 mV</td></tr><tr><td colspan="2">Return</td><td>Calibration data</td></tr></table>		 diag	<input type="checkbox"/> 220 mV <input type="checkbox"/> 22.3 °C	<input type="checkbox"/> Cal record			Active adjustment	05/23/10 15:35		Sensor model	CPS72D-7PB21		Serial No.	9350111		Zero offset	136 mV		Redox buffer	227 mV		Delta value	1 mV		Return		Calibration data	<p>Cal Record Data of last adjustment/calibration, suitable for documentation to ISO 9000 and GLP/GMP (Date, time, calibration method, zero, information concerning redox buffers, number of previous calibrations)</p>
	 diag	<input type="checkbox"/> 220 mV <input type="checkbox"/> 22.3 °C																											
<input type="checkbox"/> Cal record																													
Active adjustment	05/23/10 15:35																												
Sensor model	CPS72D-7PB21																												
Serial No.	9350111																												
Zero offset	136 mV																												
Redox buffer	227 mV																												
Delta value	1 mV																												
Return		Calibration data																											

Memosens OXY (TAN required)

SW3400-015: Oxygen measurement

SW3400-016: Oxygen trace measurement



For connecting Memosens OXY sensors to the FIU 3400-141 module, you require the additional function SW 3400-015. For measuring oxygen traces, you require the additional function SW 3400-016.

The additional functions are device-specific. When ordering an additional function, you therefore have to specify the serial number of your FRONT module in addition to the respective order number.

(The FRONT module contains the Protos system control).

The manufacturer then supplies a TAN (transaction number) to release the additional function.

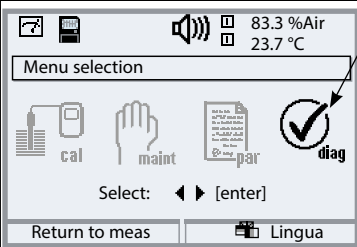
Serial number of FRONT module

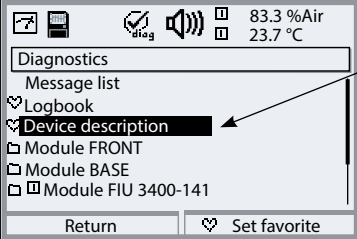
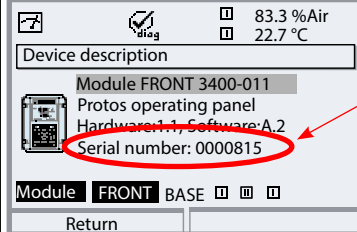
Menu	Display	Serial number FRONT module
		Menu selection Open diagnostics. From the measuring mode: Press menu key to select menu. Select diagnostics using arrow keys, confirm by pressing enter .
		Diagnostics Select "Device description" using arrow keys, confirm by pressing enter .
		Device description Enter this <u>serial number</u> when ordering an additional function.

Activating an Additional Function

Select menu: Parameter setting/System control/Release of options

Note: The TAN for releasing an additional function is only valid for the device with the corresponding serial number (see previous page).

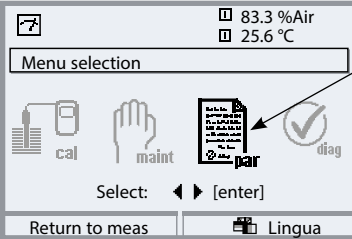
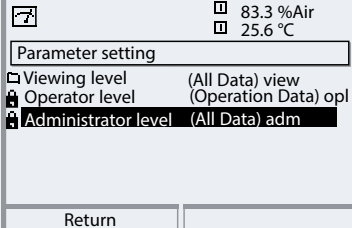
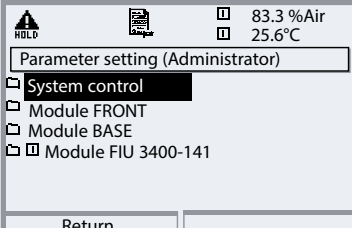
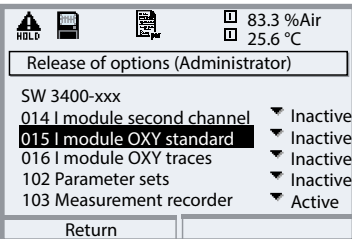
Menu	Display	Activate additional function
		<p>Menu selection</p> <p>Open parameter setting. From the measuring mode: Press menu key to select menu. Select parameter setting using arrow keys, confirm by pressing enter.</p>
		<p>Parameter setting</p> <p>Select Administrator level using arrow keys, press enter to confirm. Enter passcode and confirm (Passcode as delivered: 1989).</p>
		<p>Select system control using arrow keys, confirm by pressing enter. Then select "Release of options" using arrow keys, confirm with by pressing enter.</p>
		<p>Release of options</p> <p>Select the additional function to be released. Set option to "active". Enter the TAN at the prompt. (Note: The TAN is only valid for the device with the corresponding serial number, see previous page.) The option is available after the TAN has been entered.</p>

Memosens OXY Parameter Setting

Selecting the mode and process variable (OXY).

NOTICE: You must activate the function by entering a TAN

Note: "HOLD" mode active

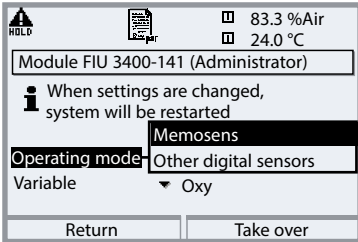
Menu	Display	Parameter setting
		<p>Select mode and process variable. Select: Parameter setting/ Module FIU 3400-141/ Operating mode: Memosens, Variable: OXY. When you have changed the operat- ing mode or the process variable (or selected it for the first time), press the "Take over" softkey to confirm.</p>

After restart, a connected Memosens sensor is displayed immediately:

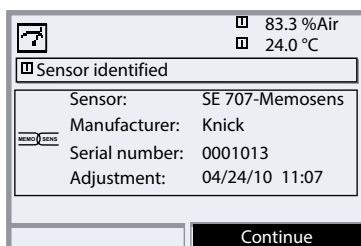

All sensor-typical parameters are automatically sent to the analyzer.

These are, for example, the measuring range, zero and slope of the sensor. Without any further parameter setting, measurement starts at once, the measuring temperature is simultaneously detected.



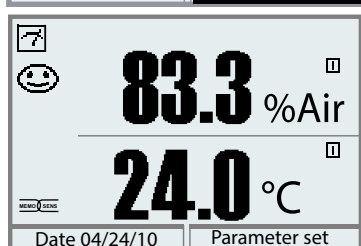







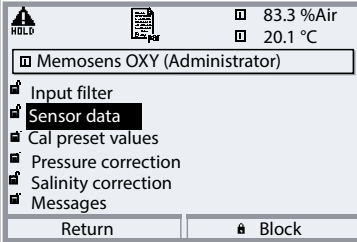

With "Plug&Measure", premeasured Memosens sensors can immediately be used for measurement without previous calibration.

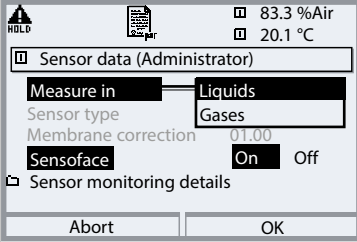

The Memosens icon is displayed as long as a Memosens sensor is connected.

Parameter Setting (Memosens OXY)

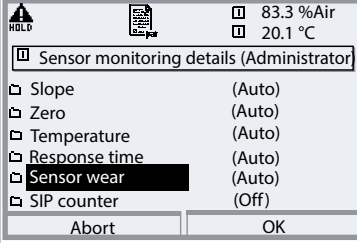
Note: HOLD mode active.

Menu	Display	Parameter selection
	 <p>   83.3 %Air 20.1 °C </p> <p> <input checked="" type="checkbox"/> Memosens OXY (Administrator) </p> <ul style="list-style-type: none">  Input filter  Sensor data  Cal preset values  Pressure correction  Salinity correction  Messages <p> <input type="button" value="Return"/> <input checked="" type="checkbox"/> Block </p>	<p>Sensor data</p> <p>Memosens sensors provide most of the parameters automatically.</p>
	 <p>   83.3 %Air 20.1 °C </p> <p> <input checked="" type="checkbox"/> Sensor data (Administrator) </p> <p> Measure in <input checked="" type="checkbox"/> Liquids <input type="checkbox"/> Gases </p> <p> Sensor type </p> <p> Membrane correction 01.00 </p> <p> Sensoface <input checked="" type="checkbox"/> On <input type="checkbox"/> Off </p> <p> <input checked="" type="checkbox"/> Sensor monitoring details </p> <p> <input type="button" value="Abort"/> <input type="button" value="OK"/> </p>	<p>Sensoface provides information on the sensor condition. In measuring mode a smiley face is displayed 😊 (friendly, neutral, sad) depending on the sensor data. Great deviations are signaled. The following parameters are monitored: slope, zero, response time and sensor wear.</p> <p>To display the "Sensoface" icon, you must activate it in the Sensor data menu (display on the left).</p>
	 <p>   83.3 %Air 20.1 °C </p> <p> <input checked="" type="checkbox"/> Sensor monitoring details (Administrator) </p> <ul style="list-style-type: none"> <input checked="" type="checkbox"/> Slope (Auto) <input checked="" type="checkbox"/> Zero (Auto) <input checked="" type="checkbox"/> Temperature (Auto) <input checked="" type="checkbox"/> Response time (Auto) <input checked="" type="checkbox"/> Sensor wear (Auto) <input checked="" type="checkbox"/> SIP counter (Off) <p> <input type="button" value="Abort"/> <input type="button" value="OK"/> </p>	<p>Sensor monitoring details</p> <p>If the entries are "(Auto)" data, they can be displayed but not edited. The values are displayed in gray. In addition, you can specify values for SIP counter and sensor operating time which will trigger a message.</p>

Parameter Setting (Memosens OXY)





Note: HOLD mode active.

Parameter	Default	Selection / Range
Input filter		
Pulse suppression	Weak	Off, Weak, Medium, Strong
Input filter	010 sec	xxx sec (entry)
Sensor data		
Measure in	Liquids	Liquids, Gases
Sensoface	On	On, Off
Sensor monitoring details		
Sensor parameters		SIP cycles and sensor operating time
Cal preset values		
Product calibration	%Air	Sat (%Air), Conc (mg/l, µg/l, ppm, ppb), p´ (mmHg, mbar)
Calibration timer		
- Monitoring	Auto	Off, Auto, Individual
- Cal timer	0000 h	Auto: 720 h (or entry: xxxx h)
Pressure correction		
Pressure transmitter	Absolute	Absolute
I input	4 ... 20 mA	0 ... 20 mA / 4 ... 20 mA
Start 0(4) mA	0000 mbar	xxxx mbar
End (20 mA)	9999 mbar	xxxx mbar
Pressure during meas	Manual	Manual (default 1013 mbar), External
Pressure during cal	Manual	Manual (default 1013 mbar), External
Salinity correction		
Entry	Salinity	Salinity, Chlorinity, Conductivity (00.00 g/kg or 0.000 µS/cm, depending on selection)
Messages Liquid (gas messages marked with *)		
Messages Saturation %Air	Off	Off, Variable limits
Messages Saturation %O ₂	Off	Off, Variable limits
Messages Concentration*	Off	Off, Variable limits
Messages Partial pressure*	Off	Off, Variable limits

Parameter Setting (Memosens OXY)

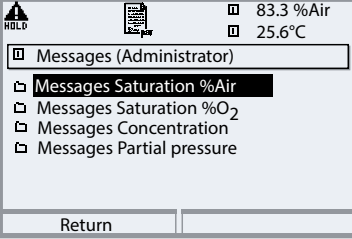
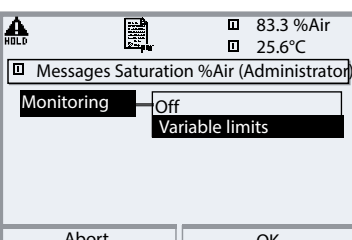
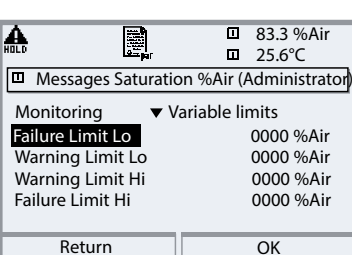
Messages

Note: HOLD mode active

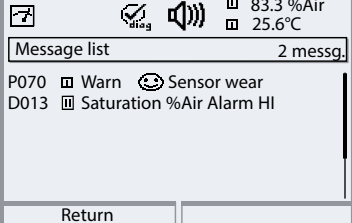
Menu	Display	Messages
	  	<p>Messages</p> <p>All parameters determined by the measuring module can generate messages.</p> <p>Device limits max.:</p> <p>Messages are generated when the process variable (eg, saturation) is outside the measuring range. The “Failure” icon is displayed, the NAMUR failure contact is activated (BASE module, factory setting: contact K4, N/C contact). The current outputs can signal a 22-mA message (user defined).</p> <p>Variable limits:</p> <p>For the “failure” and “warning” messages you can define upper and lower limits for message generation.</p> <p>Message icons</p> <ul style="list-style-type: none">  Failure (Failure limit HiHi/LoLo)  Maintenance (Warning limit Hi/Lo)  Limit indication (here: lower range)
		<p>Diagnostics menu</p> <p>When the “Maintenance” or “Failure” icons are blinking in the display, you should access the Diagnostics menu. The messages are displayed in the “Message list”.</p>

Memosens OXY Calibration / Adjustment

Note: The HOLD mode is active for the currently calibrated module, the current outputs behave as configured.



With Memosens sensors, the calibration data are stored in the sensor.

This allows using precalibrated sensors.

When the Protos is used for precalibrating sensors in the lab, you can use the calibration routines described below.

Calibration/adjustment methods

- Automatic calibration in water/air
- Product calibration (saturation/concentration/partial pressure)
- Data entry
- Zero correction
- **Calibration:** Detecting deviations without readjustment
- **Adjustment:** Detecting deviations with readjustment

NOTICE:

Without adjustment every dissolved oxygen meter delivers an imprecise or wrong output value! After replacing the sensor, the electrolyte, or the sensor membrane, you must perform a calibration.

The resulting values must be taken over by an adjustment for calculating the measured variables (measured-value display, output signals)!

Procedure

Every oxygen sensor has its individual slope and zero point. Both values are altered, for example, by aging. For sufficiently high accuracy of oxygen measurement, the meter must be regularly adjusted for the sensor data (adjustment).

Adjustment (Memosens OXY)

Adjustment means that the values determined by a calibration are taken over. The values determined for zero and slope are entered in the calibration record. (Cal record can be called in the Diagnostics menu for Memosens OXY.)

These values are only effective for calculating the measured variables when the calibration has been terminated with an adjustment.

A passcode ensures that an adjustment can only be performed by an authorized person (Administrator).

The Operator can check the current sensor data by a calibration and inform the Administrator when there are deviations.

You can use the additional function SW 3400-107 for granting access rights (passcodes) and for AuditTrail (continuous data recording and backup according to FDA 21 CFR Part 11).

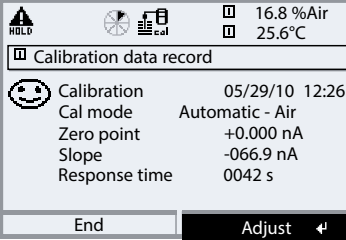
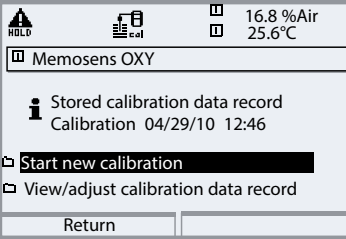
Menu	Display	Adjustment after calibration
		<p>Administrator</p> <p>With the corresponding access rights, the device can immediately be adjusted after calibration. The calibration values are saved in the sensor and taken over for calculating the measured variables.</p>
		<p>Operator (without administrator rights)</p> <p>After calibration, change to measuring mode. Inform Administrator. When opening the menu (Calibration, respective module), the Administrator sees all data of the last calibration and can take over the values or perform a new calibration.</p>

Adjustment (Memosens OXY)

Recommendations for Calibration

It is always recommended to calibrate in air. Compared to water, air is a calibration medium which is easy to handle, stable, and thus safe. In the most cases, however, the sensor must be removed for a calibration in air. In certain processes the sensor cannot be removed for calibration. Here, calibration must be performed directly in the process medium (e.g. with aeration). For applications where concentration is measured, calibration in air has proved to be useful.

Common Combination: Process Variable / Calibration Mode

Measurement	Calibration
Saturation	Water
Concentration	Air

If there is a temperature difference between the calibration medium and the measured medium, the sensor must be kept in the respective medium for several minutes before and after calibration in order to deliver stable measured values. The type of calibration pressure detection is preset during parameter setting.

HOLD Function During Calibration

Behavior of the signal and relay outputs during calibration

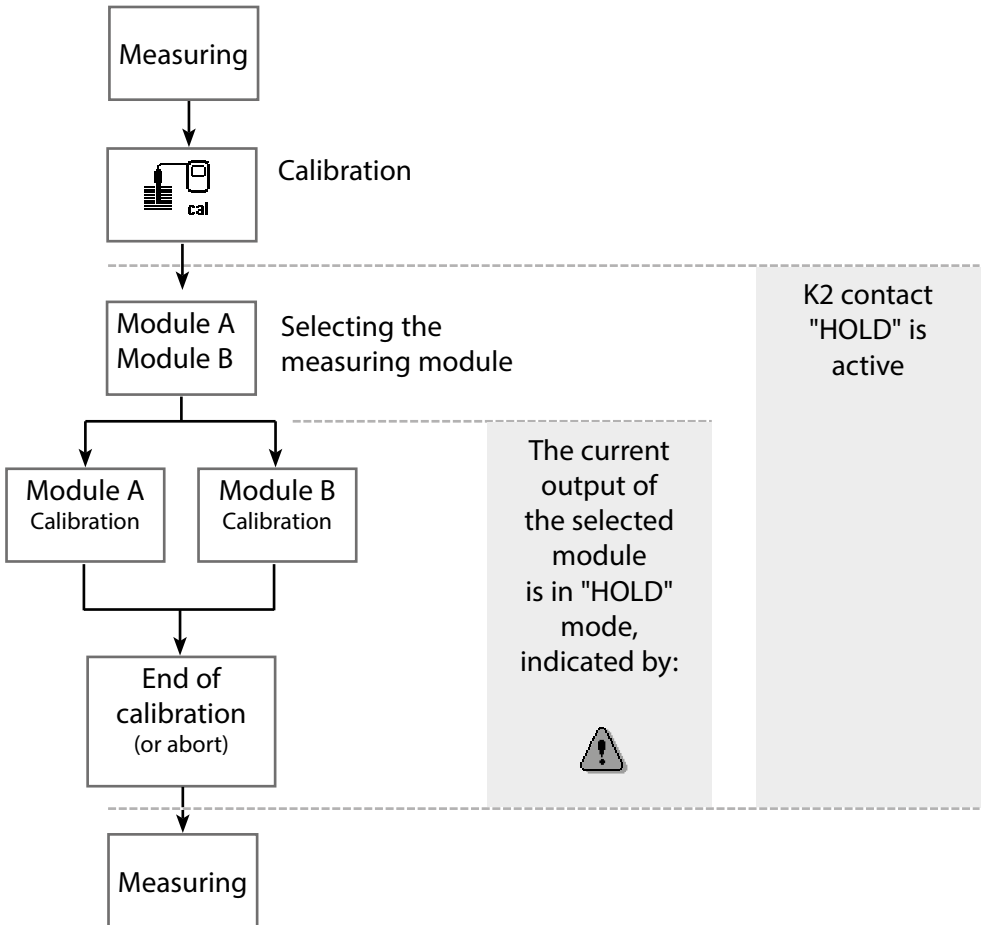

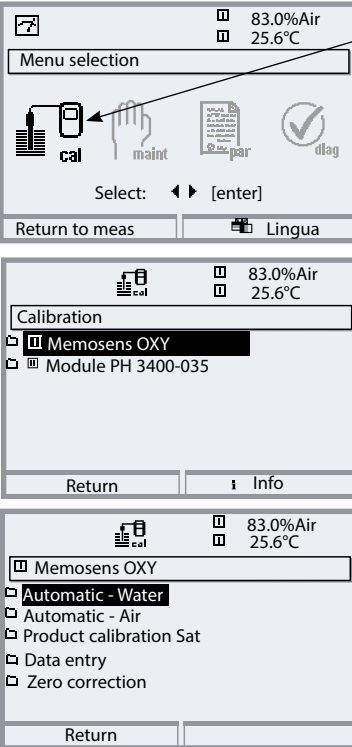
Menu	Display	Selecting a calibration method
		<p>Opening the calibration menu Press menu key to select menu. Select calibration using arrow keys, press enter to confirm, passcode 1147 (To change passcode, select: Parameter setting/System control/Passcode entry).</p> <p>Calibration: Select "Memosens OXY"</p> <p>Select a calibration method:</p> <ul style="list-style-type: none"> • Automatic - Water • Automatic - Air • Product calibration Saturation (concentration/partial pressure) • Data entry • Zero correction <p>When you access calibration, the analyzer automatically proposes the previous calibration method. If you do not want to calibrate, "Return" with the left softkey.</p> <p>During calibration the module is in HOLD mode. Current outputs and relay contacts of the module behave as configured (BASE module).</p>

Calibration / Adjustment (Memosens OXY)

Automatic Calibration in Water

Automatic Calibration in Water

The slope is corrected using the saturation value (100 %) related to air saturation.

During calibration the module is in HOLD mode. Current outputs and relay contacts of the module behave as configured (BASE module).

NOTICE!

Ensure sufficient incident flow to the sensor (see Specifications of oxygen sensors)! The calibration medium must be in equilibrium with air. Oxygen exchange between water and air is very slow. Therefore, it takes a relatively long time until water is saturated with atmospheric oxygen. If there is a temperature difference between calibration medium and measured medium, the sensor must be kept in the respective medium for several minutes before and after calibration.

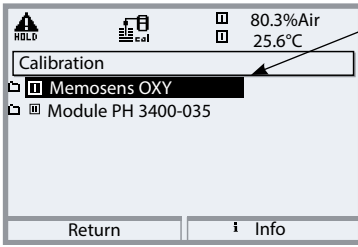
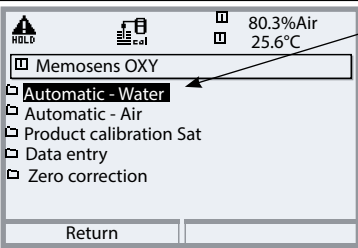
Menu	Display	Select calibration mode
		<p>Select: Memosens OXY</p> <p>The module is in HOLD mode. The assigned current outputs and relay contacts behave as configured (BASE). Press enter to confirm.</p>
		<p>Select calibration method: "Automatic - Water"</p> <p>Remove sensor and immerse it in cal medium (air-saturated water), ensure sufficient incident flow to the sensor. Press enter to confirm.</p>

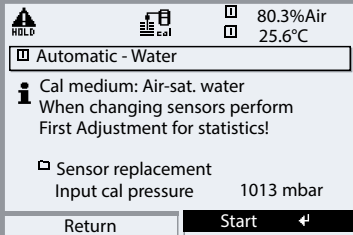
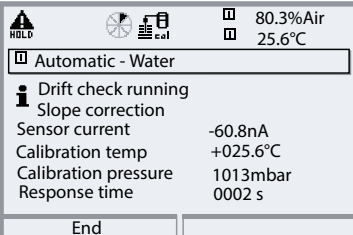
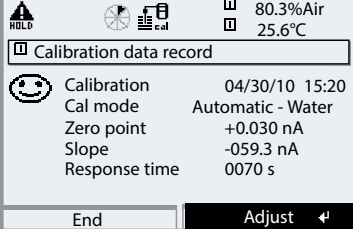
Menu	Display	Automatic calibration in water
		<p>Display of selected calibration medium (Air-sat. water) Enter cal pressure if "manual" has been configured. Start with softkey or enter</p>
		<p>Drift check. Display during calibration</p> <ul style="list-style-type: none"> • Sensor current • Calibration temperature • Calibration pressure • Response time <p>Waiting time can be reduced by pressing enter (without drift check: reduced accuracy of calibration values!). From the response time, you see how long it takes the sensor to deliver a stable signal. If the signal or the measured temperature fluctuate greatly, the calibration procedure is aborted after 2 min. You must re-start the calibration. If successful, place sensor in process, exit calibration using softkey or enter</p>
		<p>Adjustment Press "Adjust" to save the values determined during calibration in the sensor and use them for calculating the measured values.</p>

Calibration / Adjustment (Memosens OXY)

Automatic Calibration in Air

Automatic Calibration in Air

The slope is corrected using the saturation value (100 %), similar to air saturation of water. Since this analogy only applies to water-vapor saturated air (100 % relative humidity) and often the calibration air is less humid, the relative humidity of the calibration air must also be specified. If you do not know the exact value of the relative humidity of the calibration air, you can take the following reference values for a sufficiently precise calibration:

- Ambient air: 50 % rel. humidity (average)
- Bottled gas (synthetic air): 0 % rel. humidity

NOTICE!

The sensor membrane must be dry. Be sure to keep temperature and pressure constant during calibration. If there is a temperature difference between calibration medium and measured medium, the sensor must be kept in the respective medium for several minutes before and after calibration.

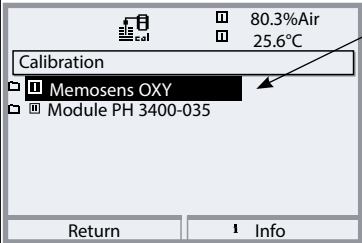
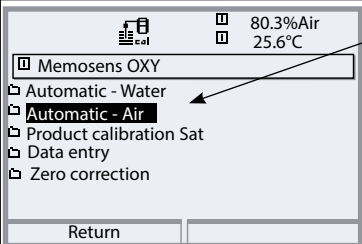
Menu	Display	Select calibration mode
		<p>Select: Memosens OXY</p> <p>The module is in HOLD mode. The assigned current outputs and relay contacts behave as configured (BASE). Press enter to confirm.</p>
		<p>Select calibration method: "Automatic - Air"</p> <p>Remove sensor and place it in air.</p> <p>Press enter to confirm.</p>

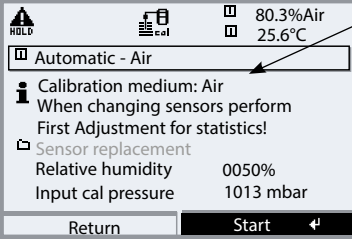
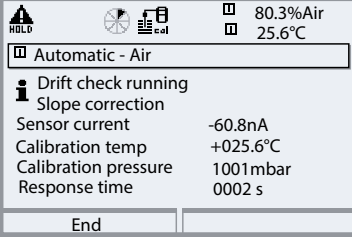
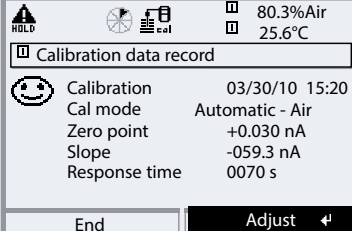
Menu	Display	Automatic calibration in air
		<p>Calibration medium: Air Select: First Adjustment Enter relative humidity, eg:</p> <ul style="list-style-type: none"> Ambient air: 50 % Bottled gas: 0 % <p>Enter cal pressure if "manual" has been configured. Start using softkey or enter</p>
		<p>Drift check. Display during calibration</p> <ul style="list-style-type: none"> Sensor current, calibration pressure and response time. <p>Waiting time can be reduced by pressing "End" (without drift check: reduced accuracy of calibration values!). From the response time, you see how long it takes the sensor to deliver a stable signal. If the signal or the measured temperature fluctuate greatly, the calibration procedure is aborted after approx. 2 min. You must re-start the calibration. If successful, replace sensor in the process. Exit calibration using softkey or enter.</p>
		<p>Adjustment Press "Adjust" to save the values determined during calibration in the sensor and use them for calculating the measured values.</p>

Calibration / Adjustment (Memosens OXY)

Product calibration (saturation/concentration/partial pressure [hPa, mmHg] – preset in: Parameter setting / Cal preset values)

Product Calibration (Calibration with Sampling)

When the sensor cannot be removed – eg, for sterility reasons – its slope can be determined with “sampling”. To do so, the currently measured saturation value of the process is saved by the Protos. Directly afterwards, a reference value is determined using a portable meter, for example. The reference value is entered into the measuring system. From the difference between measured value and reference value, the Protos calculates the correction values of the sensor. With low saturation values, the Protos corrects the zero point, with high values the slope.

During calibration the module is in HOLD mode. Current outputs and relay contacts of the module behave as configured (BASE module).

NOTICE!

The reference value must be measured at temperature and pressure conditions similar to those of the process.

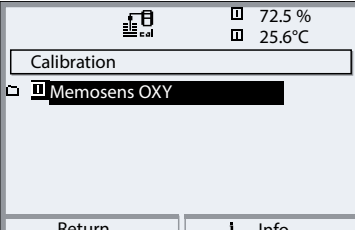
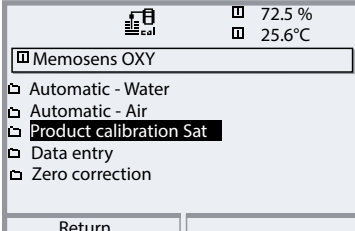
Menu	Display	Product calibration
		<p>Select: Memosens OXY</p> <p>The module is in HOLD mode. The assigned current outputs and relay contacts behave as configured (BASE). Press enter to confirm.</p>
		<p>Select calibration mode: “Product calibration”.</p> <p>Sat (or Conc, p’) is preset in Parameter setting / Cal preset values. Press enter to confirm.</p>

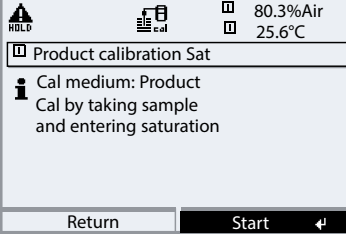
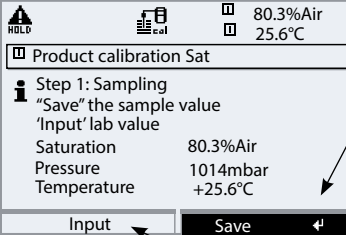
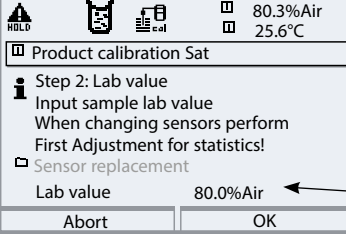
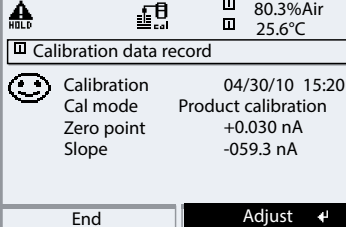
Menu	Display	Product calibration: Saturation
	 	<p>Product calibration Sat</p> <p>Product calibration is performed in 2 steps.</p> <p>Prepare reference measurement (eg, with portable meter), start by pressing softkey or enter</p> <p>Step 1</p> <p>Take sample.</p> <p>Save measured value and temperature at the moment of sampling ("Save" softkey or enter).</p> <p>Press meas to return to measurement.</p> <p>Exception:</p> <p>Sample value can be measured on the site and be entered immediately.</p> <p>To do so, press "Input" softkey.</p>
		<p>Step 2</p> <p>Lab value has been measured.</p> <p>When you open the Product calibration menu again, the display shown on the left appears:</p> <p>Enter reference value ("Lab value"). Press "OK" to confirm.</p>
		<p>Adjustment</p> <p>Press "Adjust" to save the values determined during calibration in the sensor and use them for calculating the measured values.</p>

Calibration / Adjustment (Memosens OXY)

Data Entry of Premeasured Sensors

Data Entry of Premeasured Sensors

Entry of values for slope and zero point of a sensor, related to 25°C, 1013 mbar.

During calibration the module is in HOLD mode. Current outputs and relay contacts of the module behave as configured (BASE module).

Slope = Sensor current at 100 % atmospheric oxygen, 25 °C, 1013 mbar

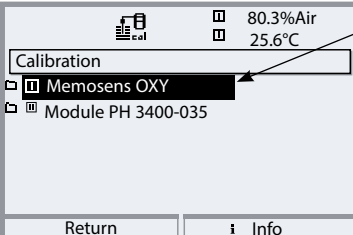
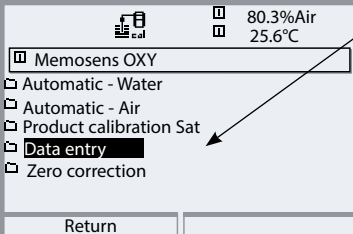
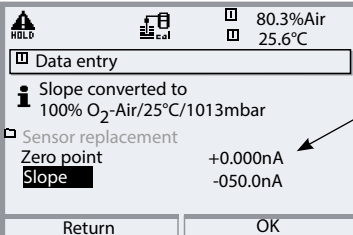
Menu	Display	Data entry of premeasured sensors
	 <p>80.3%Air 25.6°C</p> <p>Calibration</p> <ul style="list-style-type: none"> ▣ Memosens OXY ▣ Module PH 3400-035 <p>Return i Info</p>	<p>Select: Memosens OXY Press enter to confirm.</p>
	 <p>80.3%Air 25.6°C</p> <p>Memosens OXY</p> <ul style="list-style-type: none"> ▣ Automatic - Water ▣ Automatic - Air ▣ Product calibration Sat ▣ Data entry ▣ Zero correction <p>Return</p>	<p>Select calibration method: "Data entry"</p> <p>Press enter to confirm.</p>
	 <p>HOLD 80.3%Air 25.6°C</p> <p>Data entry</p> <ul style="list-style-type: none"> ▣ Slope converted to 100% O₂-Air/25°C/1013mbar ▣ Sensor replacement Zero point +0.000nA Slope -050.0nA <p>Return OK</p>	<p>The module is in HOLD mode!</p> <p>Enter the values for slope, zero point. The data are saved in the sensor. Press "OK" to confirm.</p>

Calibration / Adjustment (Memosens OXY)

Zero Correction

Zero Correction

For trace measurements below 500 ppb, the zero point should be calibrated. If a zero correction is performed, the sensor should remain for at least 10 to 60 minutes in the calibration medium (media containing CO₂: at least 120 min) to obtain stable, non-drifting values. During zero correction, a drift check is not performed.

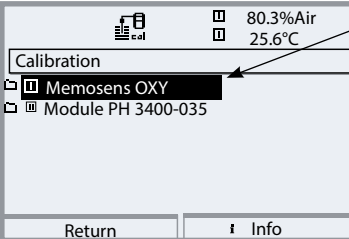
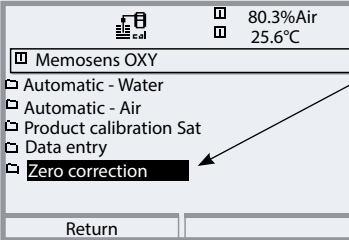
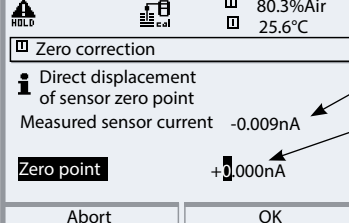
Menu	Display	Zero correction
	 <p>80.3%Air 25.6°C</p> <p>Calibration</p> <ul style="list-style-type: none">Memosens OXYModule PH 3400-035 <p>Return Info</p>  <p>80.3%Air 25.6°C</p> <p>Memosens OXY</p> <ul style="list-style-type: none">Automatic - WaterAutomatic - AirProduct calibration SatData entryZero correction <p>Return</p>  <p>HOLD 80.3%Air 25.6°C</p> <p>Zero correction</p> <p>Direct displacement of sensor zero point</p> <p>Measured sensor current -0.009nA</p> <p>Zero point +0.000nA</p> <p>Abort OK</p>	<p>Select: Memosens OXY</p> <p>The module is in HOLD mode. The assigned current outputs and relay contacts behave as configured (BASE). Press enter to confirm.</p> <p>Select calibration method: "Zero correction"</p> <p>Press enter to confirm.</p> <p>The module is in HOLD mode! Zero correction: Display of measured sensor current. Enter the input current for the zero point.</p> <p>The zero point is saved in the sensor. Press "OK" to confirm.</p>

Memosens OXY Maintenance

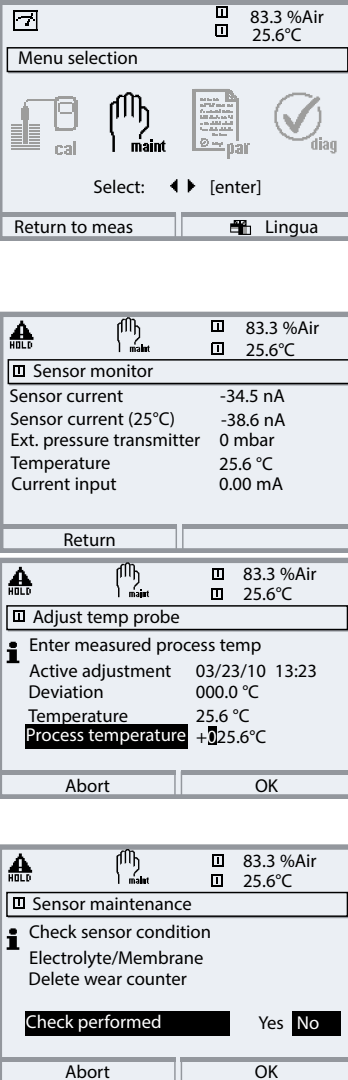

Sensor monitor, temp probe adjustment, sensor maintenance

Note: HOLD mode active

Menu	Display	Maintenance
	 <p>The screenshot shows the maintenance menu with the following options: Menu selection, cal, maint, par, and diag. The 'maint' option is selected. Below the menu, there are three sub-menus: 'Sensor monitor', 'Adjust temp probe', and 'Sensor maintenance'. Each sub-menu displays various sensor parameters and adjustment options.</p>	<p>From the measuring mode: Press menu key to select menu. Select maintenance using arrow keys, confirm by pressing enter. Passcode 2958 (To change passcode: Parameter setting/System control/Passcode entry) Then select "Memosens OXY".</p> <p>Sensor Monitor During maintenance, the sensor monitor allows validation of the sensor by immersing it in a known solution, for example, and checking the values measured.</p> <p>Temp Probe Adjustment Make sure that the process temperature is precisely measured using a calibrated reference thermometer (accuracy better than 0.1°C) when performing an adjustment. Adjustment without precise measurement might result in considerable deviations of the measured-value display! The adjustment value is stored in the Memosens.</p> <p>Sensor Maintenance Here, you can reset the wear counter when you have checked the sensor or after having replaced the membrane or the electrolyte.</p>



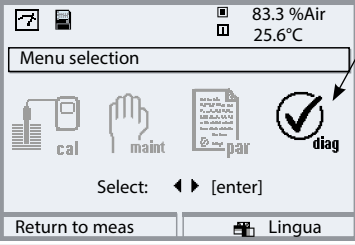

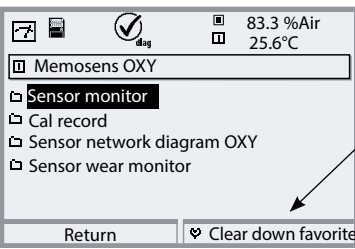
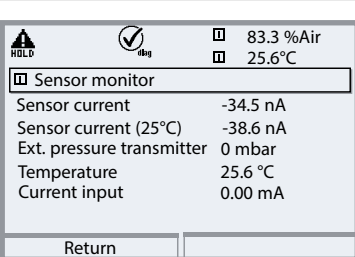

Memosens OXY Diagnostics

Sensor monitor

Menu	Display	Module diagnostics, Sensor monitor
		<p>Opening the Diagnostics menu</p> <p>From the measuring mode: Press menu key to select menu. Select diagnostics using arrow keys, press enter to confirm. Then select "Memosens OXY".</p>
		<p>The Diagnostics menu gives an overview of all diagnostics functions available. <u>Messages</u> set as "Favorite" can be called directly from the measuring mode using a softkey.</p> <p>To configure, select: Parameter setting / System control / Function control matrix.</p>
		<p>Sensor Monitor</p> <p>Shows the values for current and temperature coming from the sensor. Important function for diagnostics and validation!</p>

Diagnostics (Memosens OXY)

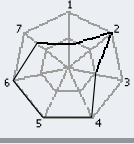
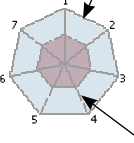
Cal record, Sensor network diagram, Sensor wear monitor

Menu	Display	Cal record, Sensor network diagram, Sensor wear monitor												
 diag	<div style="border: 1px solid black; padding: 5px;"> <div style="display: flex; justify-content: space-between; align-items: center;">   diag 83.3 %Air 25.6°C </div> <div style="border: 1px solid black; padding: 2px; margin-top: 5px;"> Cal record </div> <table style="width: 100%; border-collapse: collapse; margin-top: 5px;"> <tr><td style="width: 30%;">Active adjustment</td><td>06/09/10 09:06</td></tr> <tr><td>Sensor model</td><td>SE 707 Memosens</td></tr> <tr><td>Serial number</td><td>0077123</td></tr> <tr><td>Cal mode</td><td>Automatic - Air</td></tr> <tr><td>Zero point</td><td>0.002 nA</td></tr> <tr><td>Slope</td><td>-55.5 nA</td></tr> </table> <div style="text-align: right; margin-top: 5px;"> Return </div> </div>	Active adjustment	06/09/10 09:06	Sensor model	SE 707 Memosens	Serial number	0077123	Cal mode	Automatic - Air	Zero point	0.002 nA	Slope	-55.5 nA	<h3>Cal Record</h3> <p>Data of last calibration, suitable for documentation to ISO 9000 and GLP</p>
Active adjustment	06/09/10 09:06													
Sensor model	SE 707 Memosens													
Serial number	0077123													
Cal mode	Automatic - Air													
Zero point	0.002 nA													
Slope	-55.5 nA													
	<div style="border: 1px solid black; padding: 5px; margin-bottom: 10px;"> <div style="display: flex; justify-content: space-between; align-items: center;">   diag 83.3 %Air 25.6°C </div> <div style="border: 1px solid black; padding: 2px; margin-top: 5px;"> Sensor network diagram OXY </div> <div style="margin-top: 5px;">  <div style="margin-left: 10px;"> <ol style="list-style-type: none"> 1 - Slope 2 - Zero point 3 - Sensoscheck 4 - Not in use 5 - Response time 6 - Cal timer 7 - Sensor wear </div> </div> <div style="text-align: right; margin-top: 5px;"> Return Info </div> </div> <div style="margin-top: 10px;"> <p>“Outer circle” Value within tolerance</p>  <p>Critical range – “inner circle” Value out of tolerance</p> <p>The tolerance can be modified as required!</p> </div>	<h3>Sensor Network Diagram OXY</h3> <p>The measured values are continuously monitored during the measurement process. The sensor network diagram provides at-a-glance information about critical parameters.</p> <p>If a tolerance limit has been exceeded, the respective parameter is flashing. Values in gray: Monitoring switched off.</p>												
	<div style="border: 1px solid black; padding: 5px;"> <div style="display: flex; justify-content: space-between; align-items: center;">   diag 83.3 %Air 25.6°C </div> <div style="border: 1px solid black; padding: 2px; margin-top: 5px;"> Sensor wear monitor </div> <table style="width: 100%; border-collapse: collapse; margin-top: 5px;"> <tr><td style="width: 30%;">Sensor wear</td><td><div style="width: 100%; height: 10px; background-color: black;"></div></td></tr> <tr><td>Sensor operating time</td><td>635 d</td></tr> <tr><td>Membrane calibrations</td><td>1</td></tr> <tr><td>Membrane changes</td><td>3</td></tr> <tr><td>Sensor calibrations</td><td>24</td></tr> <tr><td>Max. temperature</td><td>33 °C</td></tr> </table> <div style="text-align: right; margin-top: 5px;"> Return </div> </div>	Sensor wear	<div style="width: 100%; height: 10px; background-color: black;"></div>	Sensor operating time	635 d	Membrane calibrations	1	Membrane changes	3	Sensor calibrations	24	Max. temperature	33 °C	<h3>Sensor Wear Monitor</h3> <p>In addition to the current sensor wear, the sensor operating time as well as the number of membrane replacements and calibrations can be seen at a glance.</p>
Sensor wear	<div style="width: 100%; height: 10px; background-color: black;"></div>													
Sensor operating time	635 d													
Membrane calibrations	1													
Membrane changes	3													
Sensor calibrations	24													
Max. temperature	33 °C													

Memosens COND Parameter Setting

Select mode and process variable (conductivity).

Note: "HOLD" mode active

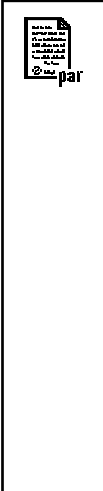
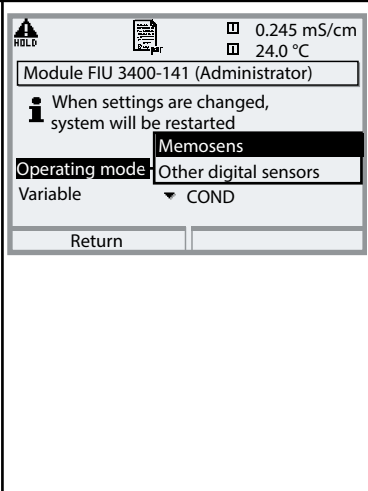
Menu	Display	Parameter setting
		<p>Select mode and process variable.</p> <p>Select: Parameter setting/ Module FIU 3400-141/ Operating mode Memosens, Variable: COND.</p> <p>When the operating mode or the process variable is changed (or selected for the first time), the analyzer automatically restarts to re-initialize the system.</p>

After restart, a connected Memosens sensor is displayed immediately:

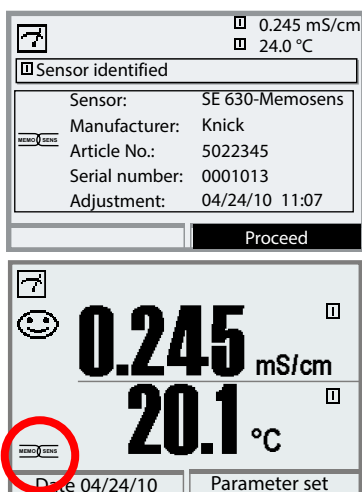

All sensor-typical parameters are automatically sent to the analyzer.

Without any further parameter setting, measurement starts at once, the measuring temperature is simultaneously detected. With "Plug&Measure", premeasured Memosens sensors can immediately be used for measurement without previous calibration.

The Memosens icon is displayed as long as a Memosens sensor is connected.

Parameter Setting (Memosens COND)

Note: HOLD mode active

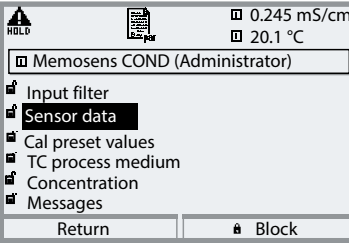
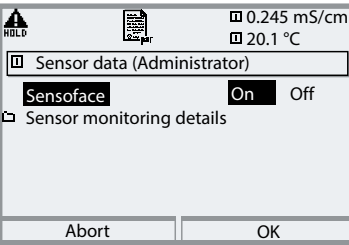
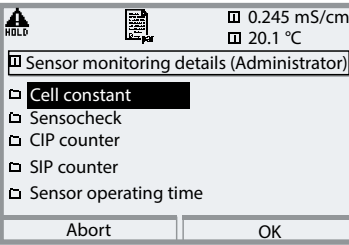
Menu	Display	Parameter selection
	  	<p>Sensor data Memosens sensors provide most of the parameters automatically.</p> <p>Sensoface provides information on the sensor condition. In measuring mode a smiley face is displayed 😊 (friendly, neutral, sad) depending on the sensor data. Sensoface monitors the sensor polarization and deviations of the cell constant and compares the number of CIP and SIP cycles with the values preset in "Sensor monitoring details".</p> <p>Sensor monitoring details If the entries are "(Auto)" data, they can be displayed but not edited. The values are displayed in gray. In addition, you can specify values for SIP counter, CIP counter and sensor operating time which will trigger a message.</p>

Parameter Setting (Memosens COND)

Parameter	Default	Selection / Range
Input filter		
Pulse suppression	Off	On, Off
Sensor data		
Sensoface	On	On, Off
Sensor monitoring details		
Cell constant	Auto	Auto, Individual
Sensocheck	Off	Off, On (Message Off/Failure/Maintenance request)
CIP counter	Off	0, Max. cycles
SIP counter	Off	0, Max. cycles
Sensor operating time	Off	Entry, max. 9999 d
Cal preset values		
Cal solution	NaCl sat	NaCl 0.01 m: 1183 µS/cm NaCl 0.1 m: 10.683 mS/cm NaCl sat: 251.3 mS/cm KCl 0.01 m: 1413 µS/cm KCl 0.1 m: 12.88 mS/cm KCl 1m: 111.80 mS/cm
Sample calibration	without TC	without TC, with TC
TC process medium		
TC correction	Off	Off, Linear, EN 27888, ultrapure water Ultrapure water: Impurity NaOH, NaCl, HCl, NH ₃
Concentration		
Concentration	Off	On, Off Medium: H ₂ SO ₄ (0 ... 30 %) H ₂ SO ₄ (32 ... 84 %) H ₂ SO ₄ (92 ... 99 %) HNO ₃ (0 ... 30 %) HNO ₃ (35 ... 96 %) HCl (0 ... 18 %) HCl (22 ... 39 %) NaOH (0 ... 14 %) NaOH (18 ... 50 %) NaCl (0 ... 26 %) Oleum (12... 45%) Table
Messages		
Messages	Temperature: Device limits max.	Conductivity, Resistivity, Concentration, Temperature, Salinity. Each variable can be moni- tored: Off, Device limits max. or variable
USP function		

Concentration Curves (Memosens COND)

Sulfuric acid H_2SO_4

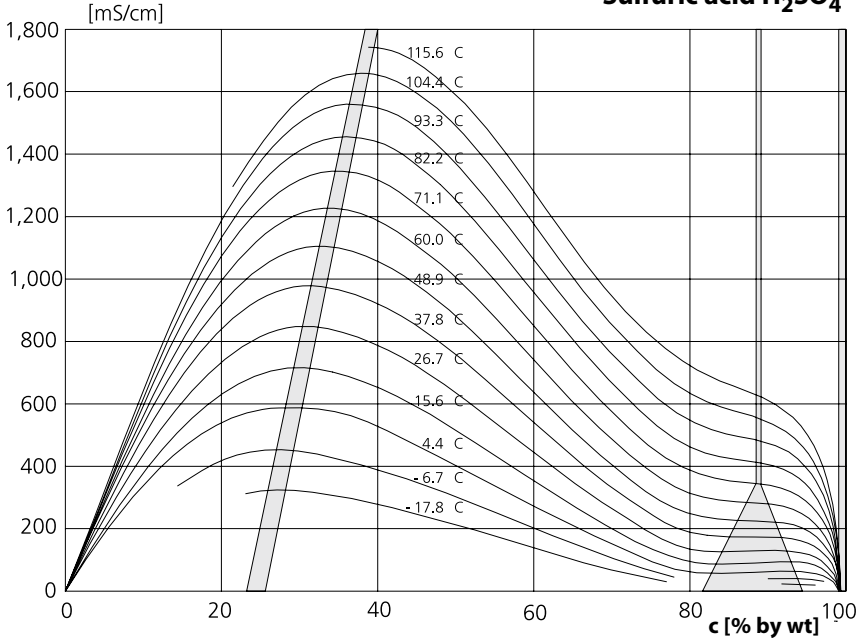

Nitric acid HNO_3

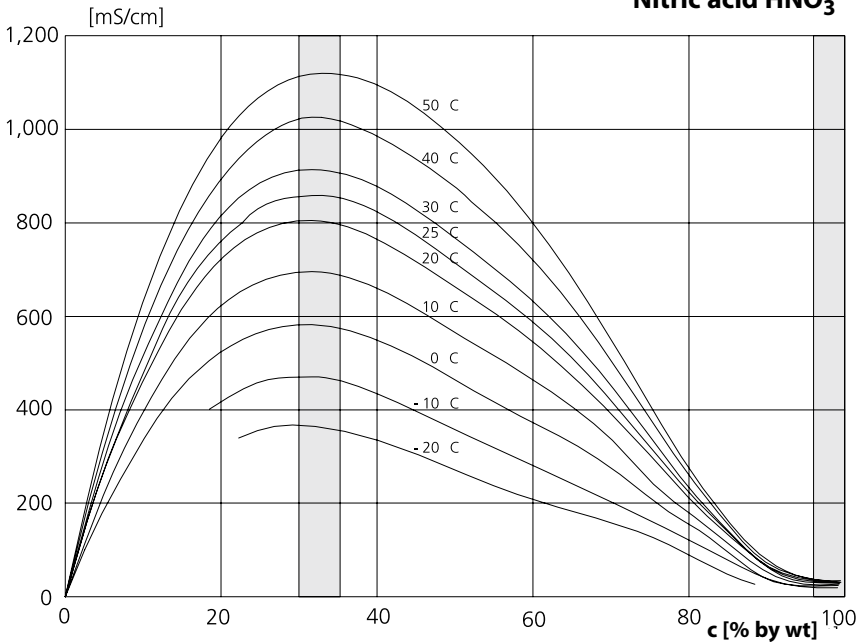

Concentration Curves (Memosens COND)

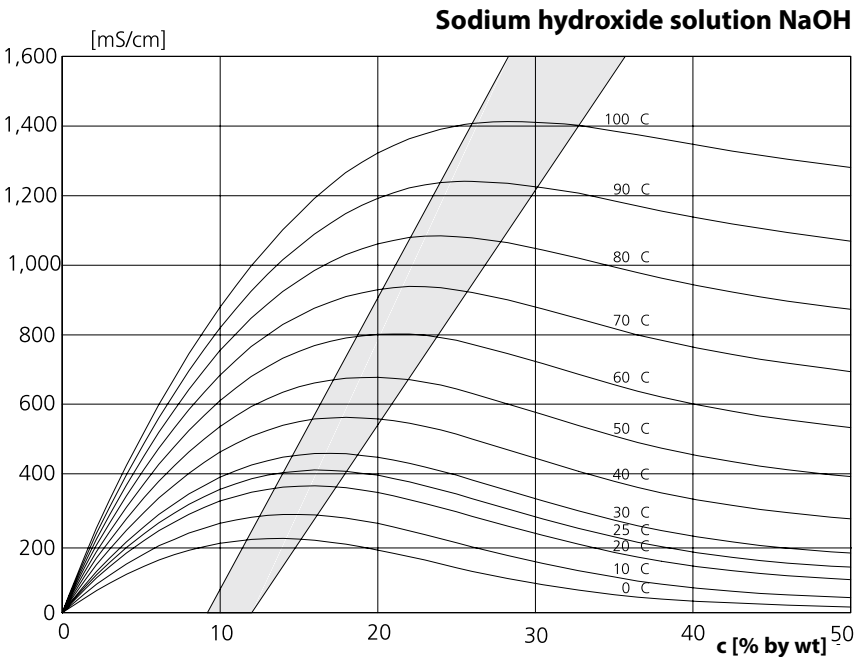
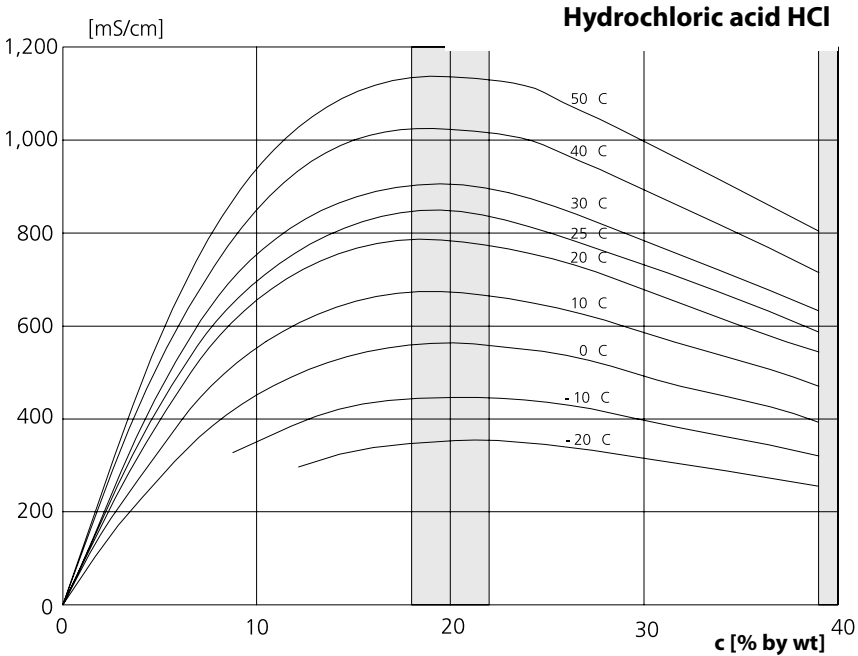

Concentration Curves (Memosens COND)

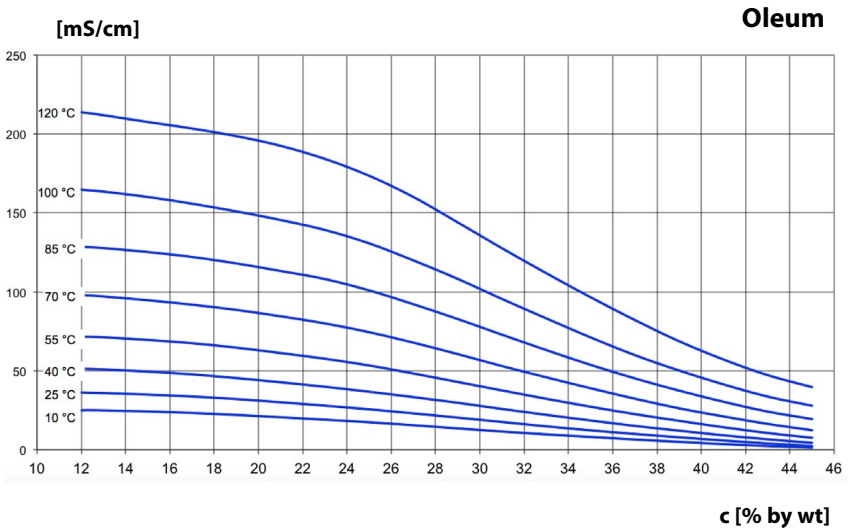
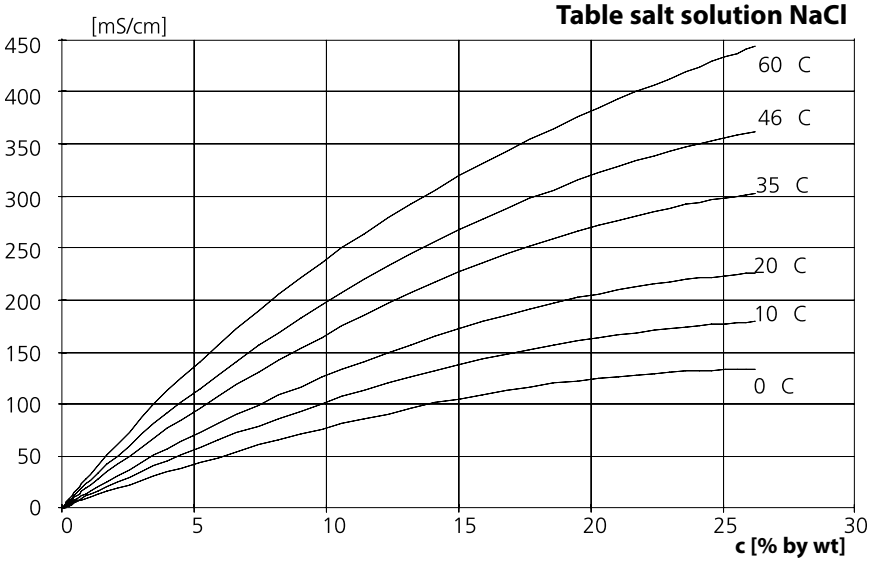

Concentration Table (Memosens COND)

Select menu: Parameter setting/System control/Concentration table
 Specifying a concentration solution for conductivity measurement

Concentration Table

To specify the customer-specific solution, 5 concentration values A-E are entered in a matrix together with 5 temperature values 1-5. To do so, first enter the 5 temperature values, then enter the respective conductivity values for each concentration A-E.

These solutions will then be available in addition to the permanently stored standard solutions (select "Table").

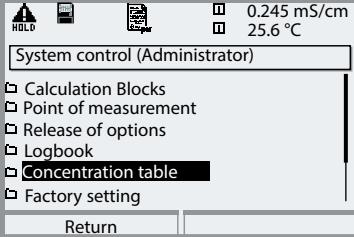
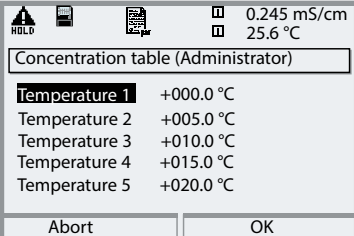
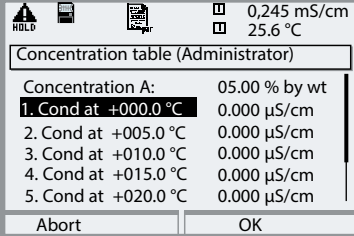
Menu	Display	Enter concentration table
		<p>Enter values</p> <ul style="list-style-type: none"> • Open parameter setting • System control • Select "Concentration table"
		<p>Enter 5 temperature values (right/left arrow keys to select position, up/down arrow keys to edit number, press enter to confirm).</p>
		<p>Enter values for concentrations A-E for the respective temperatures. The table values must be continuous. Maxima/minima are not permitted. Incorrect entries are marked with ✕.</p>

The concentration table is selected as follows:

Parameter setting / Module COND / Concentration = ON / Medium = Table.

USP Function (Memosens COND)

Monitoring of ultrapure water in the pharmaceutical industry
(Select: Parameter setting, Memosens COND)

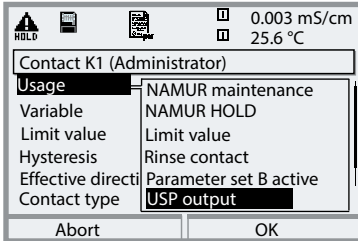

USP function, define switching output

When a Memosens COND is installed, one of the floating relay outputs of the BASE module (K1, K2 or K3) can be assigned to the USP function.

- Select parameter setting:
- Administrator level (HOLD active!)
- Module BASE: Define contact "Usage"

The USP can be selected as USP% process variable for output (display, current output, limit value, measurement recorder)

According to the "USP" directive (U.S.Pharmacopeia), Appendix 5, Section 645 "Water Conductivity" the conductivity of pharmaceutical waters can be monitored online.

To do so, the conductivity is measured without temperature compensation and compared with limit values. The water is usable without further test steps when the conductivity is below the USP limit.

Reduced limit:

The USP limit can be reduced down to 10 % (Parameter setting).

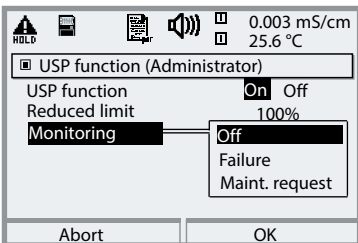

Select USP function

- Select parameter setting, then:
- Administrator level (HOLD active!)
- Memosens COND: USP function

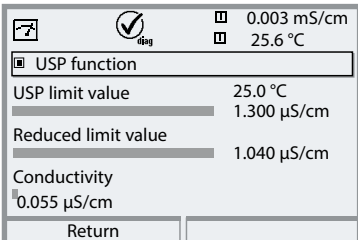

USP function. Diagnostics

- Select diagnostics:
- Memosens COND
- USP function: Display of USP limit, reduced limit, conductivity

pH Value Calculation (Memosens COND)

Note: 2 Memosens COND sensors required

pH value calculation by means of dual conductivity measurement

When monitoring boiler feed water in power plants, the pH value can be calculated by means of a dual conductivity measurement. For that purpose, the boiler feed water conductance is measured before and after the ion exchanger. This commonly used method of indirect pH value measurement does not require much maintenance and has the following advantage:

Normal pH measurement in ultrapure water is very critical. Boiler feed water does not contain many ions. This requires the use of a special electrode, which must be calibrated constantly and the service life of which is generally rather short.

Function

The conductivity before and after the ion exchanger is measured using two Memosens COND sensors at the FIU 3400-141 module. From the two calculated conductivity values, a "Calculation Block" determines the concentration of sodium hydroxide solution and the pH value according to the calculation formulas shown below:

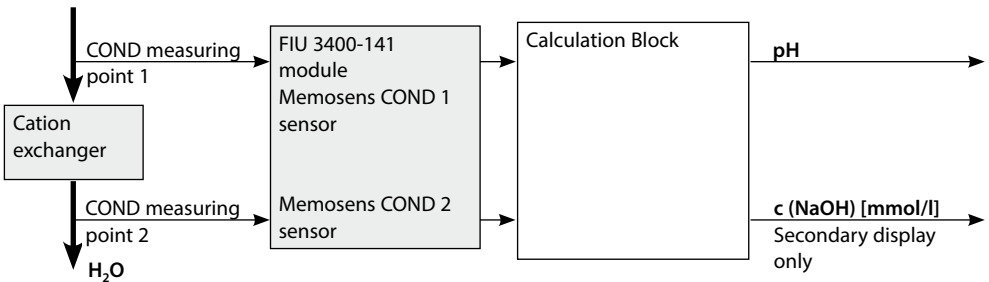

Calculating the concentration of sodium hydroxide solution / pH value:

$$c(\text{NaOH}) = \frac{\text{COND1} - 1/3 \text{COND2}}{243}$$

$$\text{pH} = 11 + \log[c(\text{NaOH})]$$

pH Value Calculation (Memosens COND)

Recommended pH ranges:

10 ± 0.2 for < 136 bar operating overpressure or

9.5 ± 0.2 for > 136 bar operating overpressure

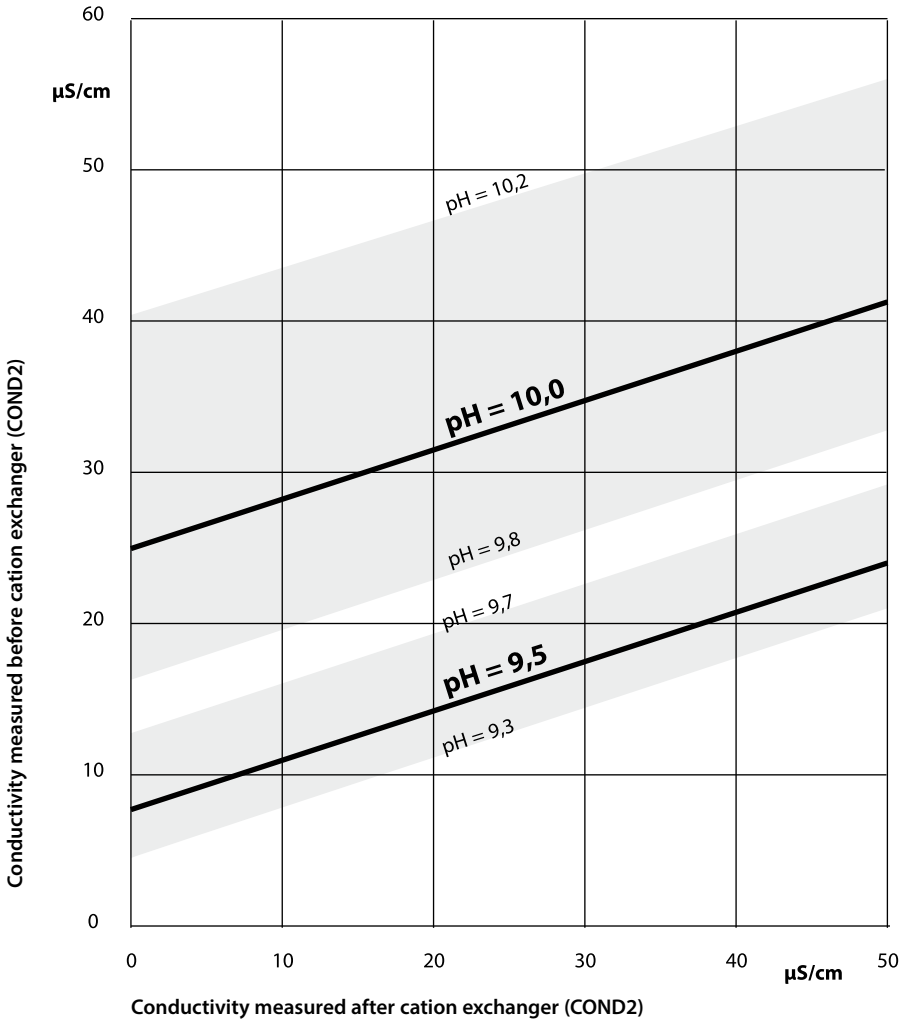

Figure:

Conditioning the feed water of natural circulation boilers with sodium hydroxide. Relationship between the pH value and the conductivity measured before and after the cation exchanger.

Source: Appendix to VGB guideline for boiler feed water, boiler water, and steam of steam generators above 68 bar permissible operating overpressure (VGB-R 450 L, edition 1988)

Calculation Blocks (Memosens COND)

Select menu: Parameter setting/System control/Calculation Blocks
Calculation of new variables from measured variables

Calculation Blocks

Two measuring modules with all their measured values serve as input for the calculation block. In addition, the general device status (NAMUR signals) is taken into account. The difference between the existing values is calculated:

Current outputs

All current outputs can be set to output the new process variables formed by the Calculation Blocks.

Measurement display

All new process variables can be displayed as primary or as secondary value.

Controller

Controller functions are not supported.

Functionality of measuring module

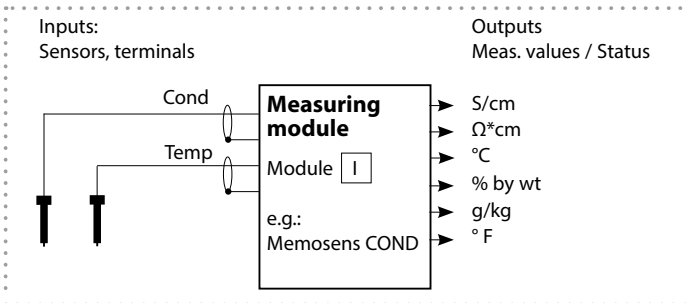

Functionality of Calculation Block

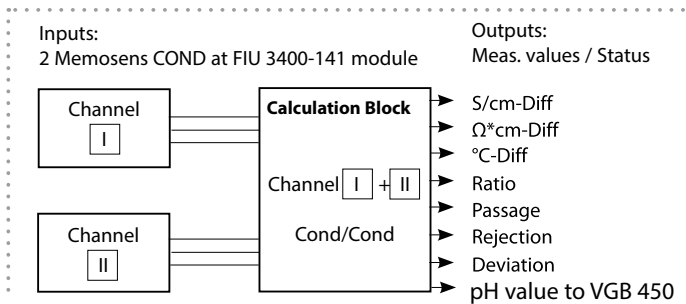

Activating Calculation Blocks (Memosens COND)

Select menu: Parameter setting/System control/Calculation Blocks
 Combining 2 Memosens COND sensors to Calculation Blocks

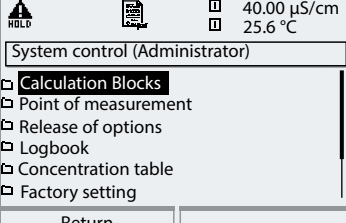
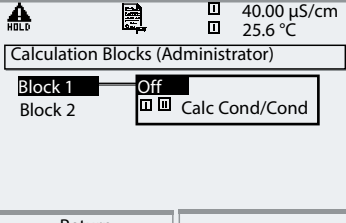
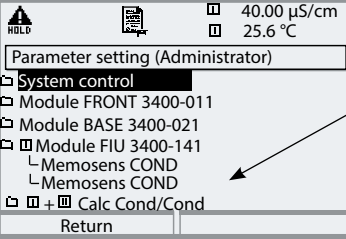
Menu	Display	Activating Calculation Blocks
		<p>Calculation Blocks</p> <ul style="list-style-type: none"> • Open parameter setting • System control • Select “Calculation Blocks”
		<ul style="list-style-type: none"> • Depending on the modules installed, the possible combinations for Calculation Blocks are offered.
		<p>During parameter setting the Calculation Blocks are displayed like modules.</p>

Configuring a Calculation Block

Select menu: Parameter setting/System control/Calculation Blocks

Setting the process variable to be calculated

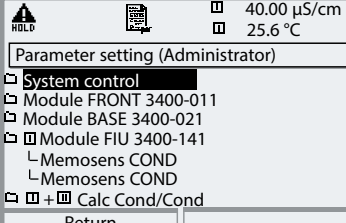
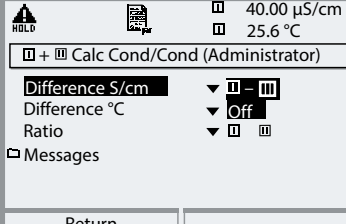
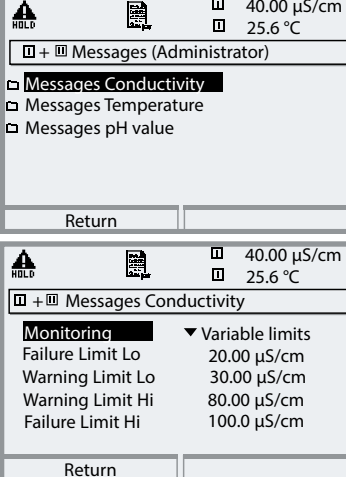
Menu	Display	Configuring a Calculation Block
		<p>Select Calculation Block</p> <ul style="list-style-type: none"> • Open parameter setting • System control • Select module
		<p>Depending on the modules installed, the possible combinations for Calculation Blocks are offered.</p>
		<p>Messages</p> <p>You can activate messages for the selected variables.</p> <p>Variables which have been set as “Off” cannot be processed further.</p> <p>The measured values which shall release a message are set using the arrow keys (left/right: select position, up/down: edit number). Press enter to confirm.</p>

Memosens COND Calibration / Adjustment

Note: HOLD mode active for the currently calibrated module
Current outputs and relay contacts behave as configured



With Memosens sensors, the calibration data are stored in the sensor.

This allows using precalibrated sensors.

When the Protos is used for precalibrating sensors in the lab, for example, you can use the calibration routines described below.

- **Calibration:** Detecting deviations without readjustment
- **Adjustment:** Detecting deviations with readjustment

NOTICE:

Without adjustment every conductivity meter delivers an imprecise or wrong output value! Every conductivity sensor has its individual cell constant. To determine the correct conductivity value, the conductivity meter must be adjusted to the sensor. From the sensor signal and the cell constant, the meter calculates the conductivity value to be displayed.

Procedure

Every conductivity sensor has its individual cell constant.

Depending on the sensor design, the cell constant may vary over a wide range. As the conductivity is calculated from the measured conductance and the cell constant, this must be known to the measuring system. For calibration or sensor standardization, either the known (stamped on) cell constant of the conductivity sensor used is entered in the measuring system or it is determined automatically by measuring a calibration solution with a known conductivity. The data are stored in a calibration record. By "Adjustment" the determined calibration data can be used for correction (see following page).

- Use fresh calibration solutions only!
- The calibration solution used must have been selected during parameter setting.
- Calibration accuracy decisively depends on the exact detection of the calibration solution's temperature. Using the measured or entered temperature, the Protos determines the nominal value for the calibration solution from a stored table.
- Observe response time of temperature probe!
- For exact determination of the cell constant, wait until the temperature probe and calibration solution have the same temperature.

Adjustment (Memosens COND)

Adjustment

means that the cell constant determined by a calibration is taken over. It is entered in the calibration record. (Cal record can be called in the Diagnostics menu for Memosens COND.) The value is only effective for calculating the measured variables when the calibration has been terminated with an adjustment and the data have been saved in the Memosens sensor. A passcode ensures that an adjustment can only be performed by an authorized person (Administrator).

The Operator can check the current sensor data by a calibration and inform the Administrator when there are deviations.

You can use the additional function SW 3400-107 for granting access rights (passcodes) and for AuditTrail (continuous data recording and backup according to FDA 21 CFR Part 11).

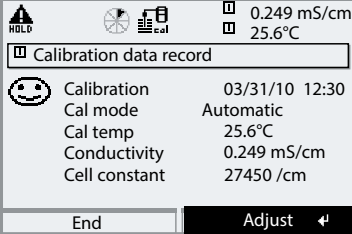
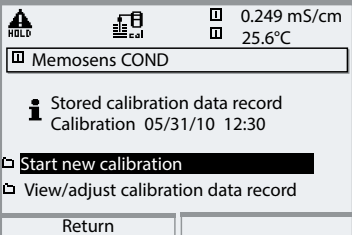
Menu	Display	Adjustment after calibration
		<p>Administrator</p> <p>With the corresponding access rights, the device can immediately be adjusted after calibration. The calibration values are taken over for calculating the measured variables.</p>
		<p>Operator (without administrator rights)</p> <p>After calibration, change to measuring mode. Inform Administrator. When opening the menu (Calibration, respective module), the Administrator sees all data of the last calibration and can take over the values or perform a new calibration.</p>

Calibration / Adjustment (Memosens COND)

Temperature Compensation

Temperature Compensation during Calibration

The conductivity value of the calibration solution is temperature-dependent. For calibration, the calibration solution temperature must therefore be known in order to choose the actual value from the conductivity table.

Automatic Temperature Compensation

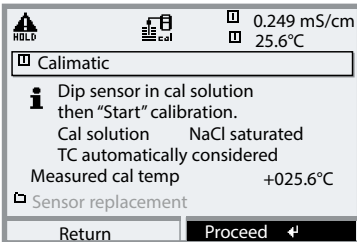



For automatic cal temp detection, the Protos measures the temperature of the calibration solution using the temperature detector integrated in the Memosens sensor.

HOLD Function During Calibration

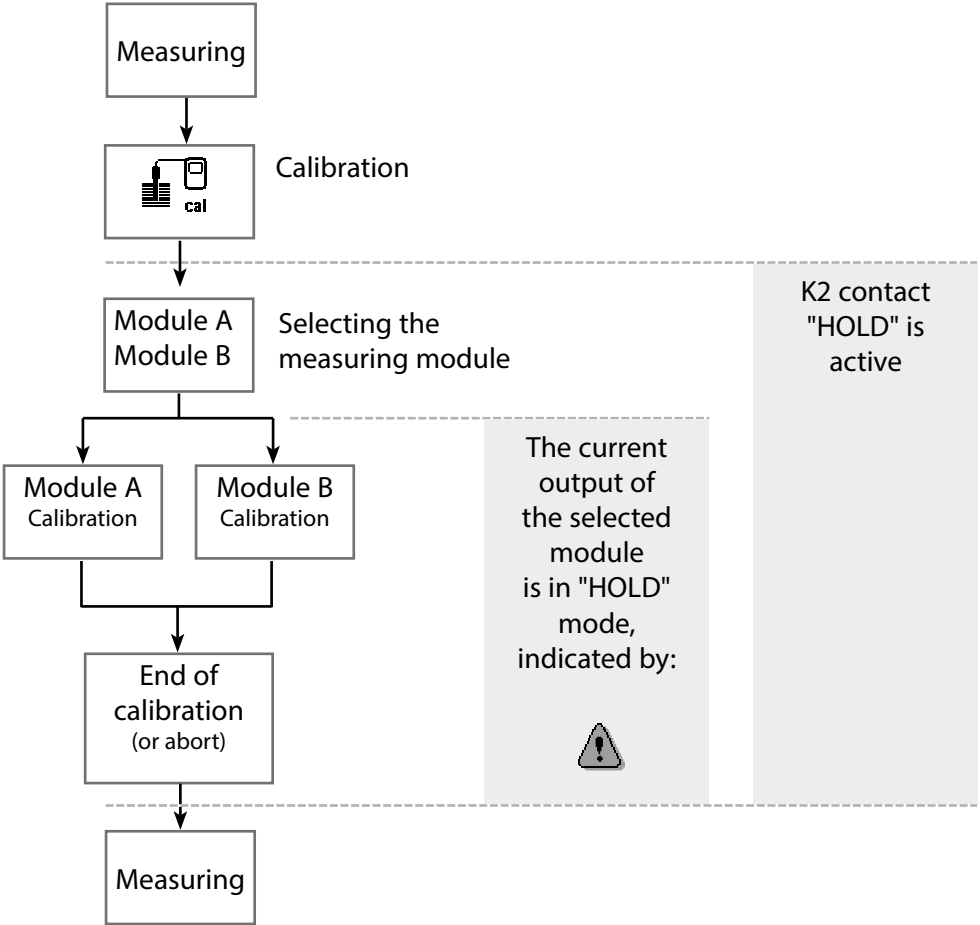
Behavior of the signal and relay outputs during calibration

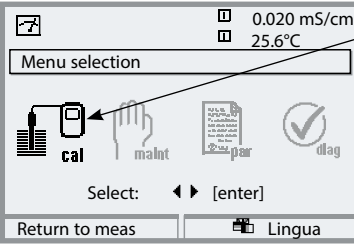

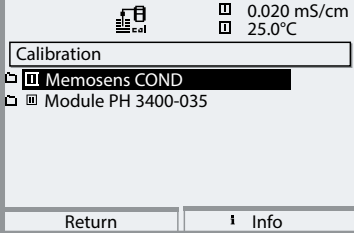
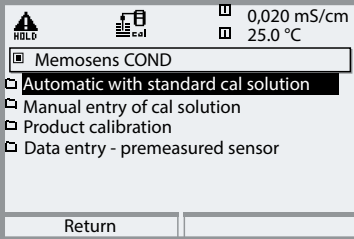
Menu	Display	Selecting a calibration method
		<p>Open Calibration Press menu key to select menu. Select calibration using arrow keys, press enter to confirm, passcode 1147 (The passcode can be edited by the administrator.)</p>
		<p>Calibration: Select "Memosens COND"</p>
		<p>Select calibration method:</p> <ul style="list-style-type: none"> • Automatic with standard cal solution • Manual entry of cal solution • Product calibration • Data entry - premeasured sensor <p>When you access calibration, the analyzer automatically proposes the previous calibration method. If you do not want to calibrate, "Return" with the left softkey.</p> <p>During calibration the module is in HOLD mode. Current outputs and relay contacts of the module behave as configured (Module BASE).</p>

Calibration / Adjustment (Memosens COND)

Automatic Calibration with Standard Calibration Solution

Automatic with Standard Cal Solution

For automatic calibration, the conductivity sensor is immersed in a standard calibration solution (NaCl or KCl, selected during parameter setting: From the measured conductance and temperature, the Protos automatically calculates the cell constant. The temperature dependence of the calibration solution is taken into account.

During calibration the module is in HOLD mode.

Current outputs and relay contacts of the module behave as configured (Module BASE).

NOTICE!

- Use fresh calibration solutions only! The calibration solution used must have been selected during parameter setting.
- Calibration accuracy decisively depends on the exact detection of the calibration solution's temperature. Using the measured or entered temperature, the Protos determines the nominal value for the calibration solution from a stored table.
- Observe response time of temperature probe!
- For exact determination of the cell constant, wait until the temperature probe and calibration solution have the same temperature.

Be sure to observe during calibration:

- If the measured conductance or the measured temperature fluctuate greatly, the calibration procedure is aborted after 2 min.
- If an error message appears, you have to repeat calibration.

Adjustment: Taking over the values determined by calibration

- When the values determined by calibration are correct, they must be taken over to adjust the analyzer. The data are saved in the Memosens sensor.

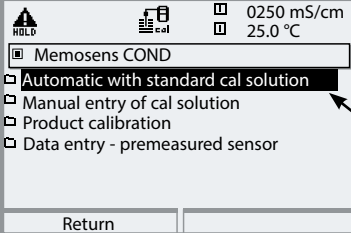
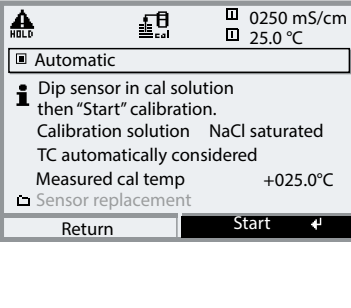
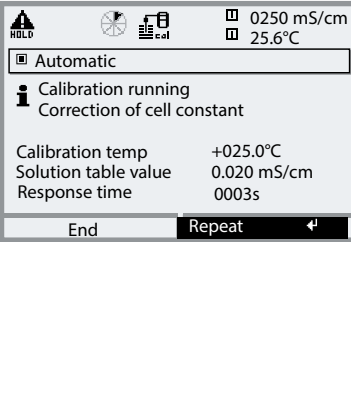
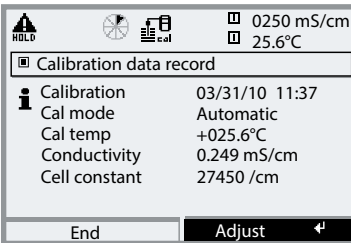
Menu	Display	Automatic calibration
		<p>Select calibration menu Select "Memosens COND"</p> <p>Select calibration method: "Automatic with standard cal solution", confirm by pressing enter.</p>
		<p>Display of selected calibration solution. Immerse sensor in calibration solution. Start calibration by pressing softkey or enter.</p>
		<p>Calibration is running. The display shows:</p> <ul style="list-style-type: none"> • Calibration temperature • Solution table value (conductivity versus cal temperature) • Response time
		<p>Adjustment Press "Adjust" to take over the values determined during calibration for calculating the measured variables to save them in the sensor.</p>

Calibration / Adjustment (Memosens COND)

Manual Entry of Cal Solution

Manual Entry of Cal Solution

For calibration with manual entry of the calibration solution's conductivity, the sensor is immersed in a calibration solution. Protos determines a conductivity/calibration temperature value pair. Then, the temperature-corrected conductivity value of the solution must be entered. To do this, read off the conductivity for the temperature displayed from the TC table of the calibration solution. Intermediate conductivity values must be interpolated. Protos automatically calculates the cell constant.

During calibration the module is in HOLD mode.

Current outputs and relay contacts of the module behave as configured (Module BASE).

NOTICE!

- Use fresh calibration solutions only!
- Calibration accuracy decisively depends on the exact detection of the calibration solution's temperature.
- Observe response time of temperature probe!
- For exact determination of the cell constant, wait until the temperature probe and calibration solution have the same temperature.

Be sure to observe during calibration:

- If the measured conductance or the measured temperature fluctuate greatly, the calibration procedure is aborted after 2 min.
- If an error message appears, you have to repeat calibration.

Adjustment: Taking over the values determined by calibration

- When the values determined by calibration are correct, they must be taken over to adjust the analyzer. The data are saved in the Memosens sensor.

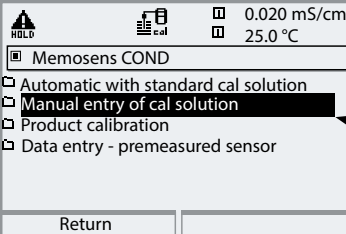
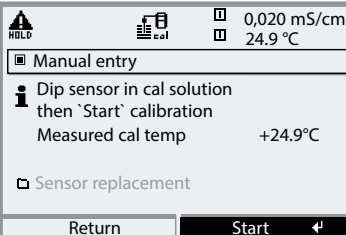
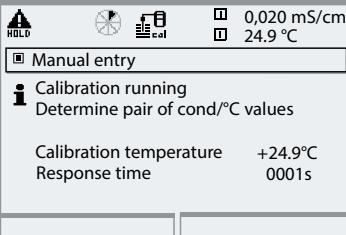
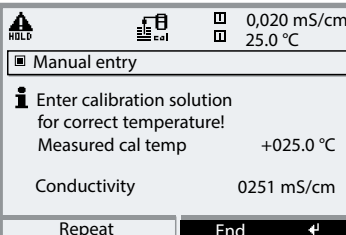
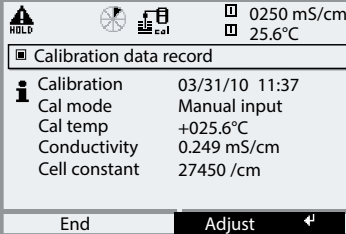
Menu	Display	Manual entry of cal solution
		<p>Select calibration menu Select Memosens COND</p> <p>Select calibration method: "Manual entry of cal solution", confirm by pressing enter.</p>
		<p>Immerse sensor in cal solution. Start calibration by pressing softkey or enter.</p>
		<p>Calibration is running. The display shows:</p> <ul style="list-style-type: none"> • Calibration temperature • Response time
		<p>Enter conductivity. End calibration by pressing the "End" softkey.</p>
		<p>Adjustment Press "Adjust" to take over the values determined during calibration for calculating the measured variables and to save the data in the Memosens sensor.</p>

Calibration / Adjustment (Memosens COND)

Product Calibration

Product Calibration

When the sensor cannot be removed, e.g. for sterility reasons (for biotechnical processes), its cell constant can be determined with "sampling".

To do so, the currently measured process value is stored by the Protos.

Immediately afterwards, you take a sample from the process. The sample value should be measured at process conditions (same temperature!). The determined value is entered in the measuring system. From the difference between process value and sample value, the Protos calculates the cell constant of the conductivity sensor.

During calibration the module is in HOLD mode.

Current outputs and relay contacts of the module behave as configured (Module BASE).

- **Product calibration without TC correction**

Take a sample from the process. Measure its value at the temperature at which the sample has been taken ("Sample temp", see display). To do so, it may be necessary to thermostat the sample correspondingly in the lab. Temperature compensation must be turned off at the comparison meters (TC = 0 %/K).

- **Product calibration with TC correction $T_{ref} = 25\text{ °C}$**

Take a sample from the process. When measuring in the lab (TC linear), be sure that the same values are set for reference temperature and temperature coefficient in the comparison meter and in the Protos. Furthermore, the measuring temperature should correspond to the sample temperature (see display). Transport the sample in an insulated container (Dewar).

NOTICE!

Product calibration can only be performed if the process medium is stable. That means, for example, that there are no chemical reactions which have an effect on the process conductivity. At higher temperatures, the sample values can also be invalidated due to evaporation.

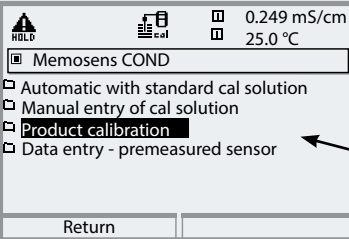
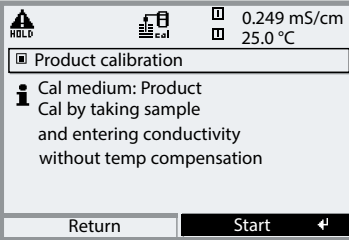
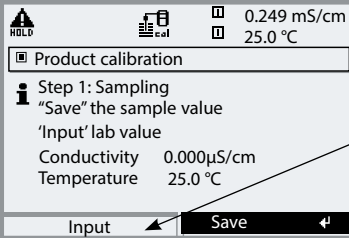
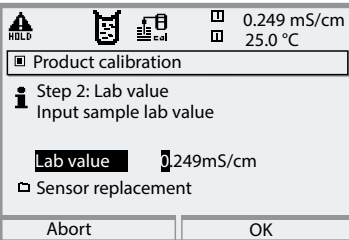
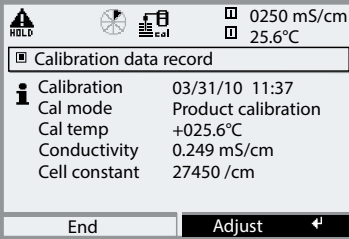
Menu	Display	Product calibration
		<p>Select calibration menu Select "Memosens COND" Select calibration method: "Product calibration", confirm by pressing enter. The module is in HOLD mode!</p>
		<p>Step 1 Take sample. Save measured value and temperature at the moment of sampling ("Save" softkey or enter). The analyzer automatically returns to calibration mode selection. Press meas to return to measurement.</p>
		<p>Exception: Sample value can be measured on the site and be entered immediately. To do so, press "Input" softkey.</p>
		<p>Step 2 Lab value has been measured. When you open the Product calibration menu again, the display shown on the left appears: Enter reference value ("Lab value"). Confirm by pressing "OK" or repeat calibration.</p>
		<p>Adjustment Press "Adjust" to take over the values determined during calibration for calculating the measured variables and to save the data in the Memosens sensor.</p>

Calibration / Adjustment (Memosens COND)

Data Entry of Premeasured Sensors

Data Entry of Premeasured Sensors

Entry of cell constant and zero point of a sensor, related to 25°C, 1013 mbar.

During calibration the module is in HOLD mode.

Current outputs and relay contacts of the module behave as configured (Module BASE).

If **concentration measurement** is activated, this menu also shows the concentration value and directly adjusts it depending on the cell constant. This allows direct calibration of the concentration value.

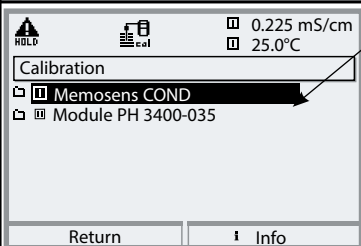
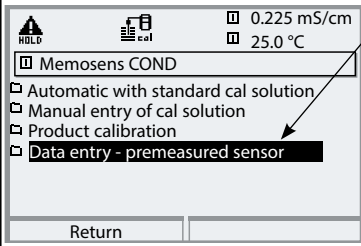
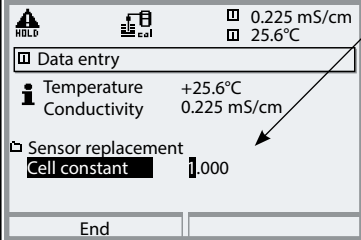
Menu	Display	Data entry of premeasured sensors
		<p>Select module: COND</p> <p>During calibration, the output currents (1 and 2), limit contacts, and controller output are in HOLD mode. Press enter to confirm.</p>
		<p>Select "Data entry" calibration method.</p> <p>Press enter to confirm.</p>
		<p>Enter cell constant of premeasured sensor</p> <p>Confirm by pressing "OK" or repeat calibration.</p> <p>The cell constant is saved in the Memosens sensor.</p>

Calibration (Memosens COND)

Calibrating the Sensors

Sensor Calibration













Since the cell constant is subject to production-related variances, the dismounted sensor should be calibrated with a calibration solution (e.g. NaCl saturated). The cell constant of the sensor – particularly of a fringe-field sensor – depends on the type of installation:

- When the sensor is mounted in a free space (minimum distances exceeded), the cell constant can be entered directly as given in the specifications.
Calibration method: "Data entry"
- When mounted in restricted space (minimum distances not kept), the sensor must be calibrated when mounted since the resulting cell constant has changed. Calibration method: "Product calibration"

Memosens COND Maintenance



Sensor monitor / Temp probe adjustment

Note: HOLD mode active

Menu	Display	Maintenance
 maint	<div style="border: 1px solid black; padding: 5px;"> <div style="display: flex; justify-content: space-between;">  0.245 mS/cm 25.6°C </div> <div style="border: 1px solid black; padding: 2px; margin: 5px 0;">Menu selection</div> <div style="display: flex; justify-content: space-around; align-items: center;"> <div style="text-align: center;">  cal </div> <div style="text-align: center;">  maint </div> <div style="text-align: center;">  par </div> <div style="text-align: center;">  diag </div> </div> <div style="text-align: center; margin-top: 5px;">Select: ◀ ▶ [enter]</div> <div style="display: flex; justify-content: space-between; margin-top: 5px;"> Return to meas  Lingua </div> </div> <div style="border: 1px solid black; padding: 5px;"> <div style="display: flex; justify-content: space-between;">  HOLD  0.245 mS/cm 25.6°C </div> <div style="border: 1px solid black; padding: 2px; margin: 5px 0;">  Sensor monitor </div> <div style="margin-top: 5px;"> Resistance (c=1) 100.0 Ohm Conductance (c=1) 0.000 µS Temperature 25.6 °C </div> <div style="text-align: center; margin-top: 5px;">Return</div> </div> <div style="border: 1px solid black; padding: 5px;"> <div style="display: flex; justify-content: space-between;">  HOLD  0.245 mS/cm 25.6°C </div> <div style="border: 1px solid black; padding: 2px; margin: 5px 0;">  Adjust temp probe </div> <div style="margin-top: 5px;"> Enter measured process temp Active adjustment 03/23/10 13:23 Deviation 000.0 °C Temperature 25.6 °C Process temperature +0.25.6°C </div> <div style="display: flex; justify-content: space-between; margin-top: 5px;"> Abort OK </div> </div>	<p>From the measuring mode: Press menu key to select menu. Select maintenance using arrow keys, confirm by pressing enter. Passcode 2958 (To change passcode: Parameter setting/System control/Passcode entry) Then select "Memosens COND".</p> <p>Sensor Monitor During maintenance, the sensor monitor allows validation of the sensor by immersing it in a known solution, for example, and checking the values measured.</p> <p>Temp Probe Adjustment Make sure that the process temperature is precisely measured using a calibrated reference thermometer (accuracy better than 0.1°C) when performing an adjustment. The data are stored in the Memosens sensor. Adjustment without precise measurement might result in considerable deviations of the measured value display!</p>



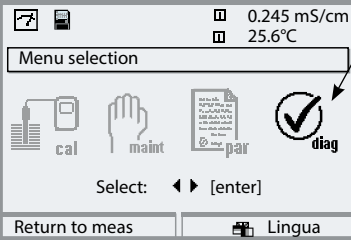

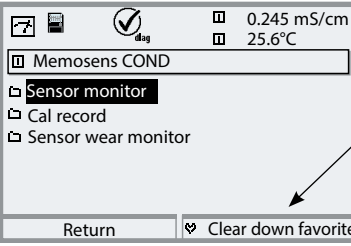
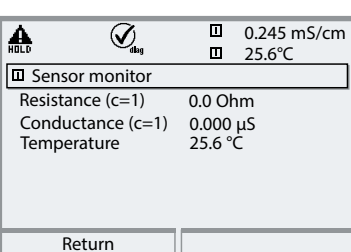
Memosens COND Diagnostics

Sensor monitor

Menu	Display	Sensor monitor
		<p>Opening the diagnostics menu</p> <p>From the measuring mode: Press menu key to select menu. Select diagnostics using arrow keys, confirm by pressing enter. Then select Memosens COND.</p>
		<p>The Diagnostics menu gives an overview of all diagnostics functions available. <u>Messages</u> set as “Favorite” can be called directly from the measuring mode using a softkey. Select: Parameter setting / System control / Function control matrix.</p>
		<p>Sensor Monitor</p> <p>Shows the values for resistance, conductance and temperature coming from the sensor. Important function for diagnostics and validation!</p>

Diagnostics (Memosens COND)

Cal Record

Menu	Display	Cal record												
 diag	<div style="border: 1px solid black; padding: 5px;"> <div style="display: flex; justify-content: space-between; align-items: center;"> <div style="display: flex; align-items: center;">    </div> <div style="text-align: right;"> 0.245 mS/cm 25.6°C </div> </div> <div style="border: 1px solid black; margin-top: 5px; padding: 2px;"> Cal record </div> <table style="width: 100%; border-collapse: collapse; margin-top: 5px;"> <tr> <td style="padding: 2px;">Active adjustment</td> <td style="padding: 2px;">06/09/10 14:06</td> </tr> <tr> <td style="padding: 2px;">Sensor model</td> <td style="padding: 2px;">SE604-MS</td> </tr> <tr> <td style="padding: 2px;">Serial number</td> <td style="padding: 2px;">0077123</td> </tr> <tr> <td style="padding: 2px;">Cal mode</td> <td style="padding: 2px;">Product cal</td> </tr> <tr> <td style="padding: 2px;">Cell constant</td> <td style="padding: 2px;">0.029</td> </tr> <tr> <td style="padding: 2px;">S/No transmitter</td> <td style="padding: 2px;">00123456</td> </tr> </table> <div style="border: 1px solid black; margin-top: 5px; padding: 2px; text-align: center;"> Return </div> </div>	Active adjustment	06/09/10 14:06	Sensor model	SE604-MS	Serial number	0077123	Cal mode	Product cal	Cell constant	0.029	S/No transmitter	00123456	<p>Cal Record</p> <p>Data of last calibration, suitable for documentation to ISO 9000 and GLP</p>
Active adjustment	06/09/10 14:06													
Sensor model	SE604-MS													
Serial number	0077123													
Cal mode	Product cal													
Cell constant	0.029													
S/No transmitter	00123456													

CONDI Parameter Setting (SE 670 Sensor)

Select mode (digital sensors) and process variable (inductive conductivity).

Note: "HOLD" mode active

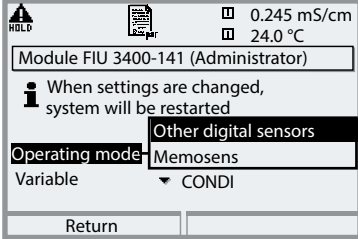
Menu	Display	Parameter setting
		<p>Select mode and process variable.</p> <p>Select: Parameter setting/Module FIU 3400-141/Operating mode: Other digital sensors, Variable: CONDI.</p> <p>When the operating mode is changed (or selected for the first time), the analyzer automatically restarts to re-initialize the system.</p>

After restart, the connected digital sensor (SE 670) is displayed immediately:

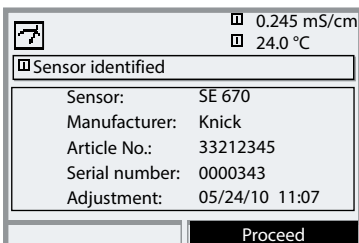

All sensor-typical parameters are automatically sent to the analyzer.

Without any further parameter setting, measurement starts at once, the measuring temperature is simultaneously detected (see also: TICK procedure, next page).

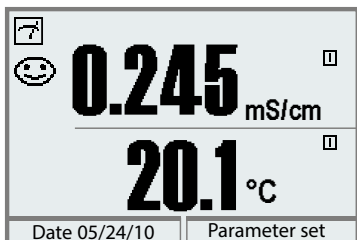

Parameter Setting (CONDI)

Note: HOLD mode active

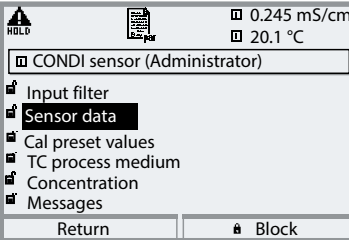
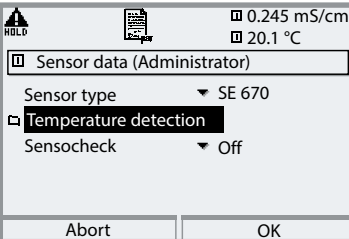
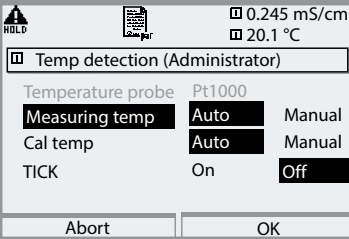
Menu	Display	Parameter selection
	  	<p>Sensor data</p> <p>The SE 670 digital sensor automatically provides the required parameters. Sensocheck monitors the cell factor for deviation. Sensoface provides information on the sensor condition. In measuring mode a smiley face is displayed 😊 (friendly, neutral, sad) depending on the sensor data.</p> <p>Temperature detection: TICK Procedure</p> <p>Conductivity measurement is very temperature-dependent. The temperature detector, however, is very slow. Therefore, it would take quite some time to achieve correct values. The patented TICK procedure allows considerably faster measurement by precalculating the temperature.</p>

Parameter Setting (CONDI)

Parameter	Default	Selection / Range
Input filter		
Pulse suppression	Off	On, Off
Sensor data		
Sensoface	On	On, Off
Temperature detection	Meas. and cal temperature: Auto, TICK = Off	
Cal preset values		
Cal solution	NaCl sat	NaCl 0.01 m: 1183 μ S/cm NaCl 0.1 m: 10,683 mS/cm NaCl Sat: 251.3 mS/cm KCl 0.01 m: 1413 μ S/cm KCl 0.1 m: 12.88 mS/cm KCl 1m: 111.80 mS/cm
Product calibration	without TC	without TC, with TC
TC process medium		
TC correction	Off	Off, linear, EN 27888
Concentration		
Concentration	Off	On, Off Medium: H ₂ SO ₄ (0 ... 30 %) H ₂ SO ₄ (32 ... 84 %) H ₂ SO ₄ (92 ... 99 %) HNO ₃ (0 ... 30 %) HNO ₃ (35 ... 96 %) HCl (0 ... 18 %) HCl (22 ... 39 %) NaOH (0 ... 14 %) NaOH (18 ... 50 %) NaCl (0 ... 26 %) Oleum (12... 45%) Table
Messages		
Messages	Temperature: Device limits max.	Conductivity, Resistivity, Concentration, Temperature, Salinity. Each variable can be monitored: Off, Device limits max. or variable

Concentration Curves (CONDI)

Sulfuric acid H_2SO_4

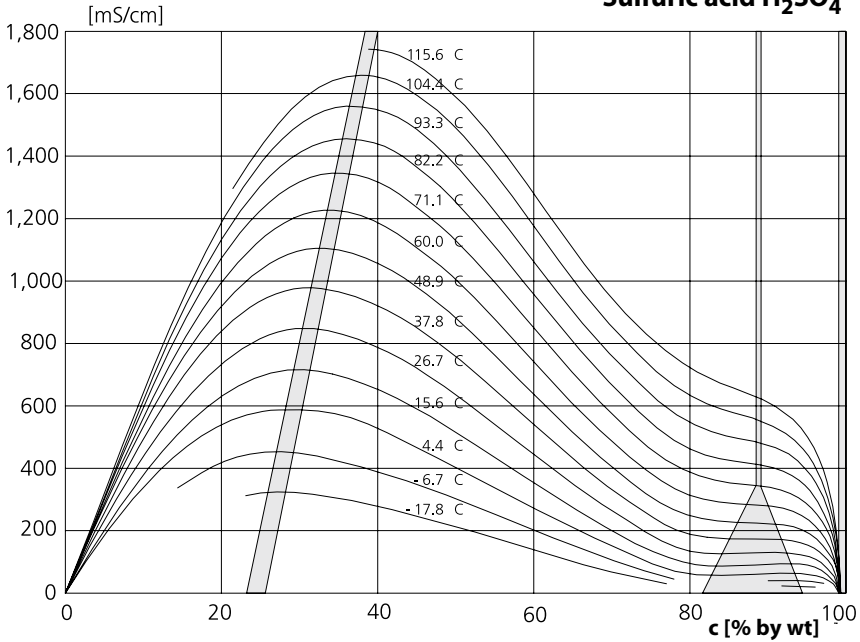

Nitric acid HNO_3

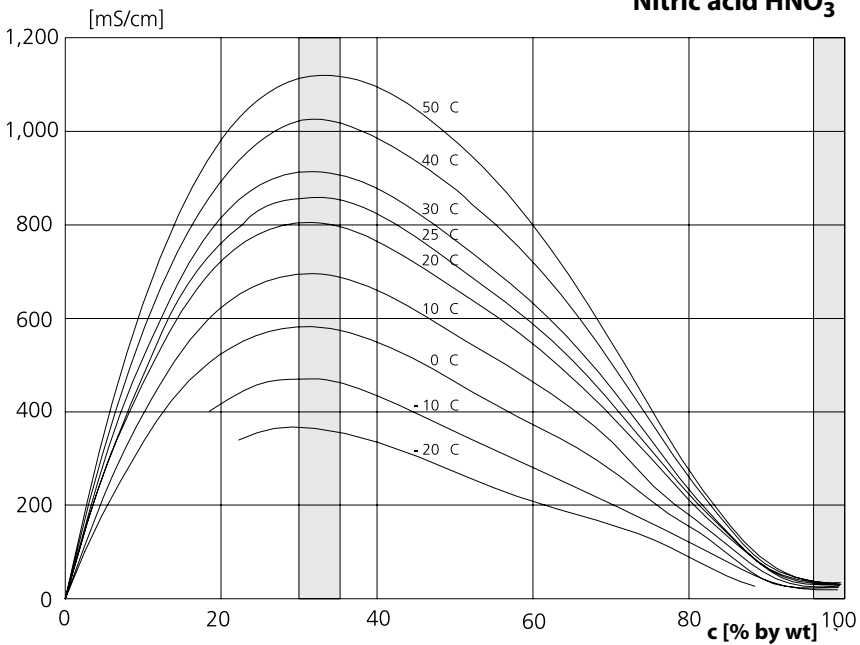

Concentration Curves (CONDI)

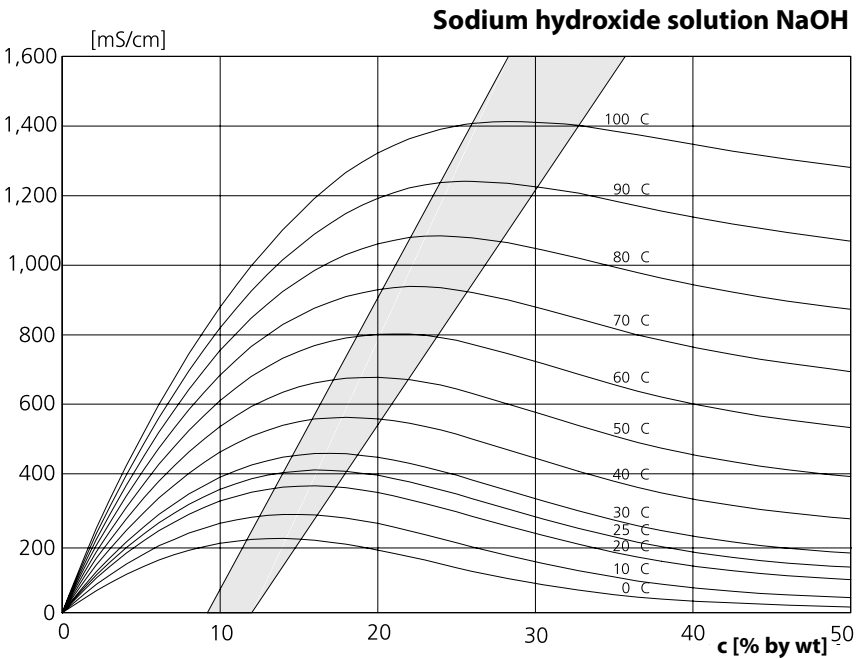
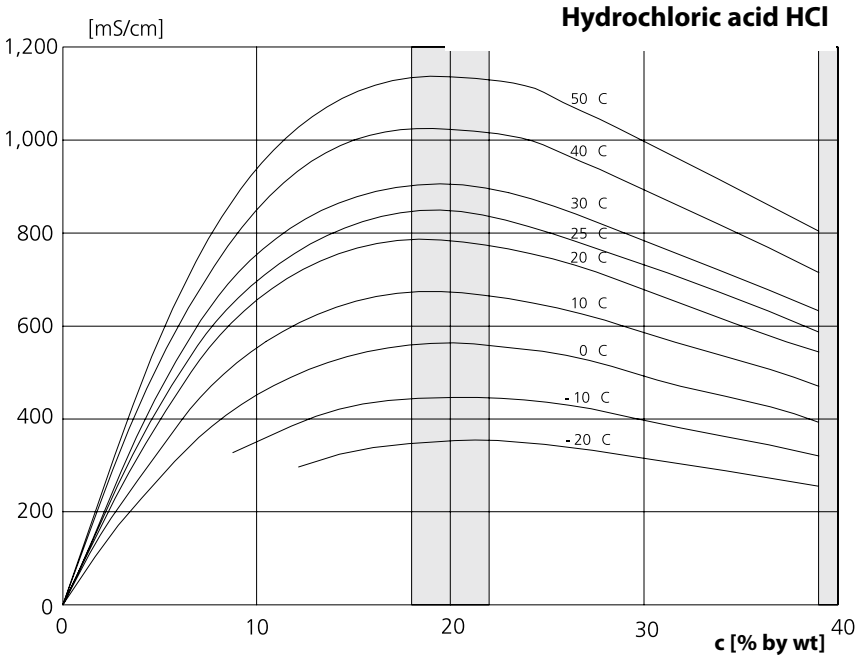

Concentration Curves (CONDI)

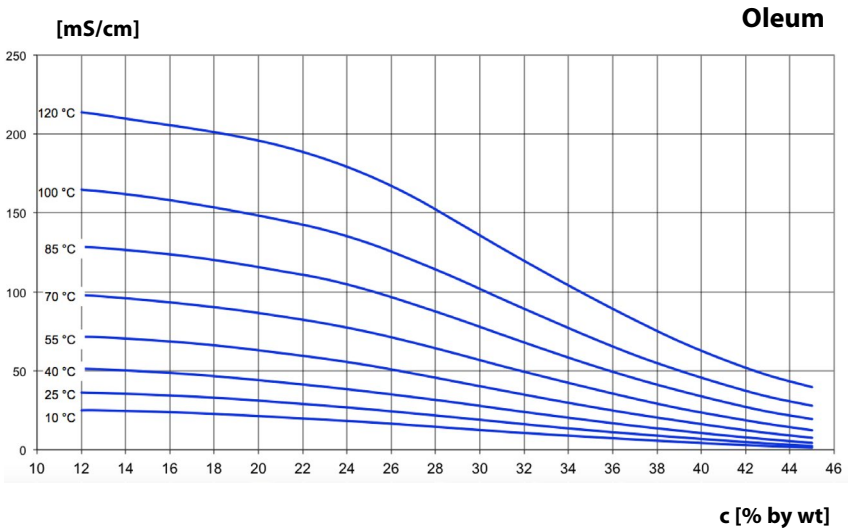
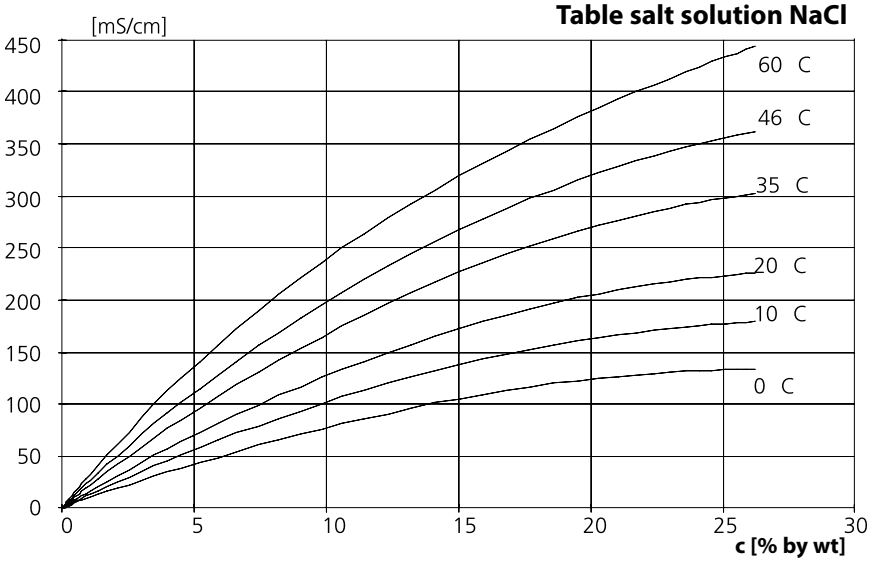

Concentration Table (CONDI)

Select menu: Parameter setting/System control/Concentration table
Specifying a concentration solution for conductivity measurement

Concentration Table

To specify the customer-specific solution, 5 concentration values A-E are entered in a matrix together with 5 temperature values 1-5. To do so, first enter the 5 temperature values, then enter the respective conductivity values for each concentration A-E.

These solutions will then be available in addition to the permanently stored standard solutions (select "Table").

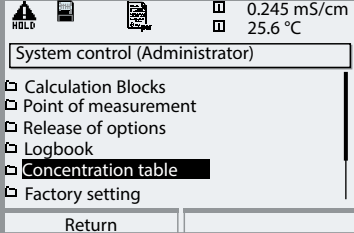
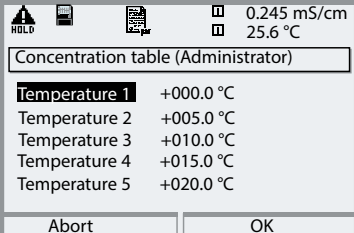
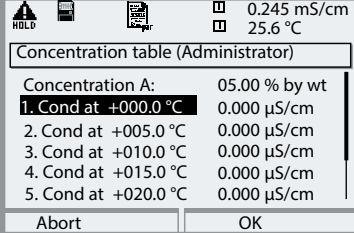
Menu	Display	Entering a concentration table
		<p>Entering values</p> <ul style="list-style-type: none"> • Open parameter setting • System control • Select "Concentration table"
		<p>Enter 5 temperature values (right/left arrow keys to select position, up/down arrow keys to edit number, press enter to confirm).</p>
		<p>Enter values for concentrations A-E for the respective temperatures. The table values must be continuous. Maxima/minima are not permitted. Incorrect entries are marked with ✕.</p>

The concentration table is selected as follows:

Parameter setting / CONDI sensor / Concentration = ON / Medium = Table.

CONDI Calibration / Adjustment

Note: HOLD mode active for the currently calibrated module
Current outputs and relay contacts behave as configured



With Memosens sensors, the calibration data are stored in the sensor.

This allows using precalibrated sensors.

When the Protos is used for precalibrating sensors in the lab, for example, you can use the calibration routines described below.

- **Calibration:** Detecting deviations without readjustment
- **Adjustment:** Detecting deviations with readjustment

NOTICE:

Without adjustment every conductivity meter delivers an imprecise or wrong output value! Every conductivity sensor has its individual cell factor. To determine the correct conductivity value, the conductivity meter must be adjusted to the sensor. From the sensor signal and the cell factor, the analyzer calculates the conductivity value to be displayed.

Procedure

Every inductive conductivity sensor has its individual cell factor.

Depending on the sensor design, the cell factor may vary. As the conductivity is calculated from the measured conductance and the cell factor, this must be known to the measuring system. For calibration or sensor standardization, either the known (stamped on) cell factor of the conductivity sensor used is entered in the measuring system or it is determined automatically by measuring a calibration solution with a known conductivity. The data are stored in a calibration record. By "Adjustment" the determined calibration data can be used for correction (see following page).

- Use fresh calibration solutions only!
- The calibration solution used must have been selected during parameter setting.
- Calibration accuracy decisively depends on the exact detection of the calibration solution's temperature. Using the measured or entered temperature, the Protos determines the nominal value for the calibration solution from a stored table.
- Observe response time of temperature probe!
- For exact determination of the cell factor, wait until the temperature probe and calibration solution have the same temperature.

Adjustment (CONDI)

Adjustment

means that the cell factor determined by a calibration is taken over. It is entered in the calibration record. (Cal record can be called in the Diagnostics menu for the CONDI sensor.) The value is only effective for calculating the measured variables when the calibration has been terminated with an adjustment.

A passcode ensures that an adjustment can only be performed by an authorized person (Administrator).

The Operator can check the current sensor data by a calibration and inform the Administrator when there are deviations.

You can use the additional function SW 3400-107 for granting access rights (passcodes) and for AuditTrail (continuous data recording and backup according to FDA 21 CFR Part 11).

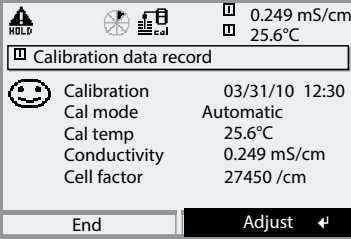
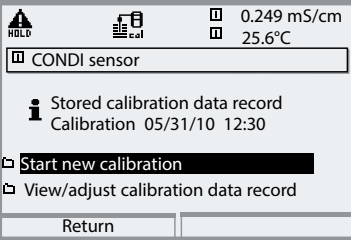
Menu	Display	Adjustment after calibration
	 <p>0.249 mS/cm 25.6°C</p> <p>Calibration data record</p> <p>Calibration 03/31/10 12:30 Cal mode Automatic Cal temp 25.6°C Conductivity 0.249 mS/cm Cell factor 27450 /cm</p> <p>End Adjust ←</p>	<p>Administrator</p> <p>With the corresponding access rights, the device can immediately be adjusted after calibration. The calibration values are taken over for calculating the measured variables.</p>
	 <p>0.249 mS/cm 25.6°C</p> <p>CONDI sensor</p> <p>Stored calibration data record Calibration 05/31/10 12:30</p> <p>Start new calibration View/adjust calibration data record</p> <p>Return</p>	<p>Operator (without administrator rights)</p> <p>After calibration, change to measuring mode. Inform Administrator.</p> <p>When opening the menu (Calibration, respective module), the Administrator sees all data of the last calibration and can take over the values or perform a new calibration.</p>

Calibration / Adjustment (CONDI)

Temperature Compensation

Temperature compensation during calibration

The conductivity value of the calibration solution is temperature-dependent. For calibration, the calibration solution temperature must therefore be known in order to choose the actual value from the conductivity table.

Automatic temperature compensation

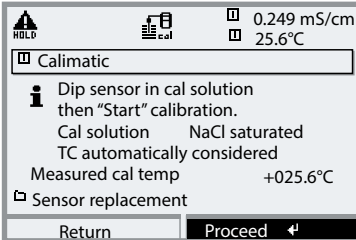



For automatic cal temp detection, the Protos measures the temperature of the calibration solution using the temperature detector integrated in the sensor.

HOLD Function During Calibration

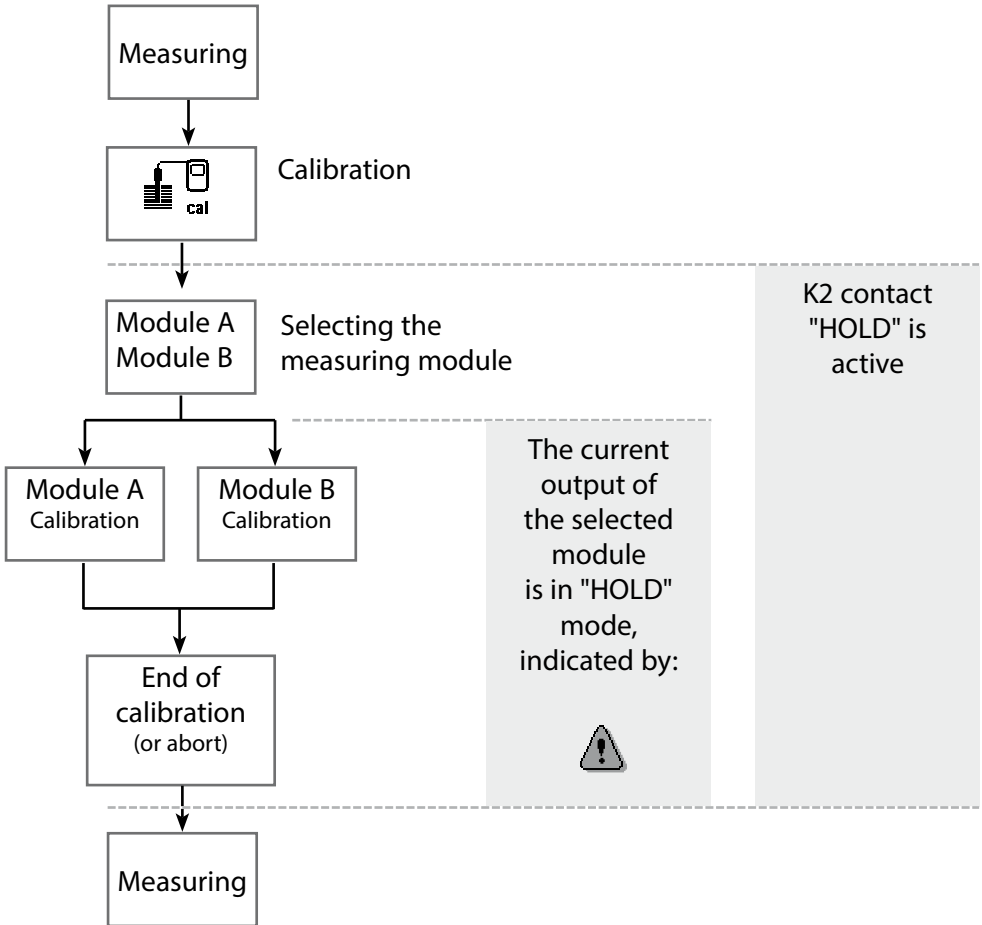
Behavior of the signal and relay outputs during calibration

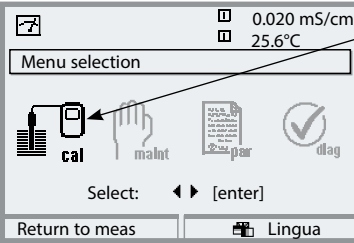

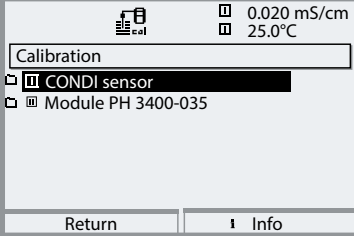
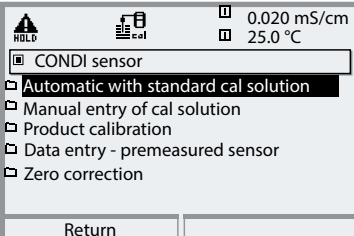
Menu	Display	Selecting a calibration method
		<p>Open Calibration Press menu key to select menu. Select calibration using arrow keys, press enter to confirm, passcode 1147 (The passcode can be edited by the administrator.)</p>
		<p>Calibration: Select "CONDI sensor"</p>
		<p>Select calibration method:</p> <ul style="list-style-type: none"> • Automatic with standard cal solution • Manual entry of cal solution • Product calibration • Data entry - premeasured sensor • Zero correction <p>When you access calibration, the analyzer automatically proposes the previous calibration method. If you do not want to calibrate, "Return" with the left softkey.</p> <p>During calibration the module is in HOLD mode. Current outputs and relay contacts of the module behave as configured (Module BASE).</p>

Calibration / Adjustment (CONDI)

Automatic Calibration with Standard Calibration Solution

Automatic with Standard Cal Solution

For automatic calibration, the conductivity sensor is immersed in a standard calibration solution (NaCl or KCl, selected during parameter setting: From the measured conductance and temperature, the Protos automatically calculates the cell factor. The temperature dependence of the calibration solution is taken into account.

During calibration the module is in HOLD mode.

Current outputs and relay contacts of the module behave as configured (Module BASE).

NOTICE!

- Use fresh calibration solutions only! The calibration solution used must have been selected during parameter setting.
- Calibration accuracy decisively depends on the exact detection of the calibration solution's temperature. Using the measured or entered temperature, the Protos determines the nominal value for the calibration solution from a stored table.
- Observe response time of temperature probe!
- For exact determination of the cell factor, wait until the temperature probe and calibration solution have the same temperature.

Be sure to observe during calibration:

- If the measured conductance or the measured temperature fluctuate greatly, the calibration procedure is aborted after 2 min.
- If an error message appears, you have to repeat calibration.

Adjustment: Taking over the values determined by calibration

- When the values determined by calibration are correct, they must be taken over to adjust the analyzer.

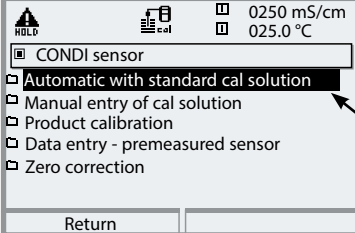
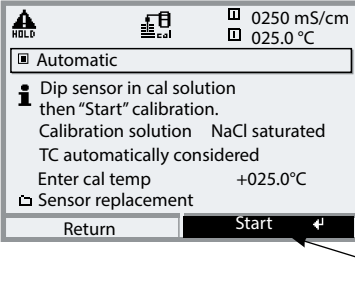
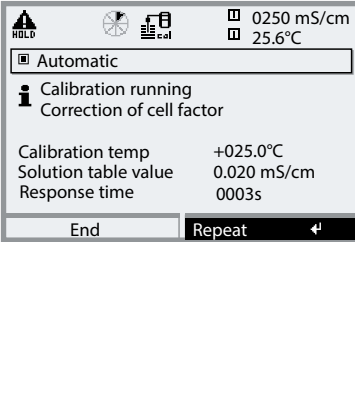
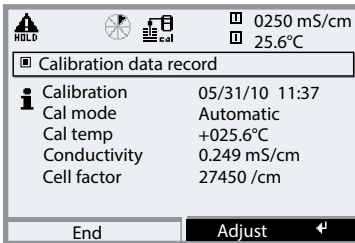
Menu	Display	Automatic calibration
		<p>Select calibration menu Select "CONDI sensor"</p> <p>Select calibration method: "Automatic with standard cal solution", confirm by pressing enter.</p>
		<p>Display of selected calibration solution.</p> <p>Enter process temperature, if manual temperature adjustment has been selected.</p> <p>Dip sensor in calibration solution. Start calibration by pressing softkey or enter.</p>
		<p>Calibration is running.</p> <p>The display shows:</p> <ul style="list-style-type: none"> • Calibration temperature • Solution table value (conductivity versus cal temperature) • Response time
		<p>Adjustment</p> <p>Press "Adjust" to take over the values determined during calibration for calculating the measured variables.</p>

Calibration / Adjustment (CONDI)

Manual Entry of Cal Solution

Manual Entry of Cal Solution

For calibration with manual entry of the calibration solution's conductivity, the sensor is immersed in a calibration solution. Protos determines a conductivity/calibration temperature value pair. Then, the temperature-corrected conductivity value of the solution must be entered. To do this, read off the conductivity for the temperature displayed from the TC table of the calibration solution. Intermediate conductivity values must be interpolated. Protos automatically calculates the cell factor.

During calibration the module is in HOLD mode.

Current outputs and relay contacts of the module behave as configured (Module BASE).

NOTICE!

- Use fresh calibration solutions only!
- Calibration accuracy decisively depends on the exact detection of the calibration solution's temperature.
- Observe response time of temperature probe!
- For exact determination of the cell factor, wait until the temperature probe and calibration solution have the same temperature.

Be sure to observe during calibration:

- If the measured conductance or the measured temperature fluctuate greatly, the calibration procedure is aborted after 2 min.
- If an error message appears, you have to repeat calibration.

Adjustment: Taking over the values determined by calibration

- When the values determined by calibration are correct, they must be taken over to adjust the analyzer.

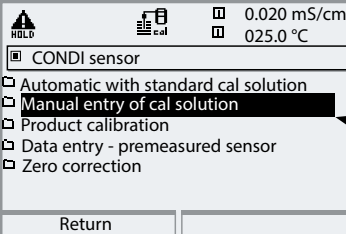
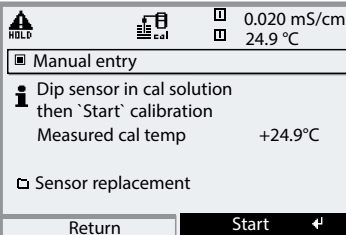
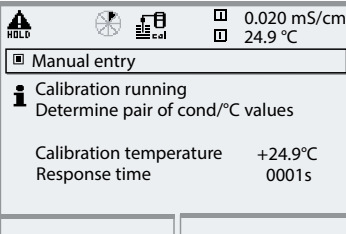
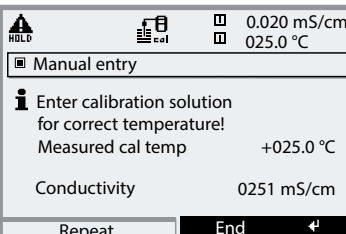
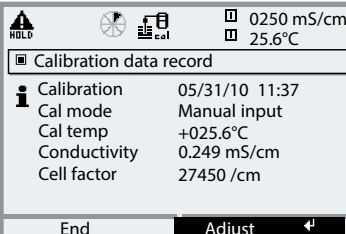
Menu	Display	Manual entry of cal solution
		<p>Select calibration menu Select CONDI sensor</p> <p>Select calibration method: "Manual entry of cal solution", confirm by pressing enter.</p>
		<p>Enter process temperature, if manual temperature adjustment has been selected. Immerse sensor in cal solution. Start calibration by pressing softkey or enter.</p>
		<p>Calibration is running. The display shows:</p> <ul style="list-style-type: none"> • Calibration temperature • Response time
		<p>Enter conductivity. End calibration by pressing the "End" softkey.</p>
		<p>Adjustment Press "Adjust" to take over the values determined during calibration for calculating the measured variables.</p>

Calibration / Adjustment (CONDI)

Product Calibration

Product Calibration

When the sensor cannot be removed, e.g. for sterility reasons (in biotechnical processes), its cell factor can be determined with "sampling".

To do so, the currently measured process value is stored by the Protos. Immediately afterwards, you take a sample from the process. The sample value should be measured at process conditions (same temperature!). The determined value is entered in the measuring system. From the difference between process value and sample value, the Protos calculates the cell factor of the conductivity sensor.

During calibration the module is in HOLD mode.

Current outputs and relay contacts of the module behave as configured (Module BASE).

- **Product calibration without TC correction**

Take a sample from the process. Measure its value at the temperature at which the sample has been taken ("Sample temp", see display). To do so, it may be necessary to thermostat the sample correspondingly in the lab. Temperature compensation must be turned off at the comparison meters (TC = 0 %/K).

- **Product calibration with TC correction $T_{ref} = 25\text{ °C}$**

Take a sample from the process. When measuring in the lab (TC linear), be sure that the same values are set for reference temperature and temperature coefficient in the comparison meter and in the Protos. Furthermore, the measuring temperature should correspond to the sample temperature (see display). Transport the sample in an insulated container (Dewar).

NOTICE!

Product calibration can only be performed if the process medium is stable. That means, for example, that there are no chemical reactions which have an effect on the process conductivity. At higher temperatures, the sample values can also be invalidated due to evaporation.

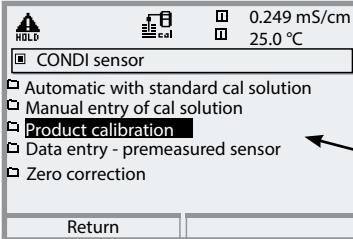
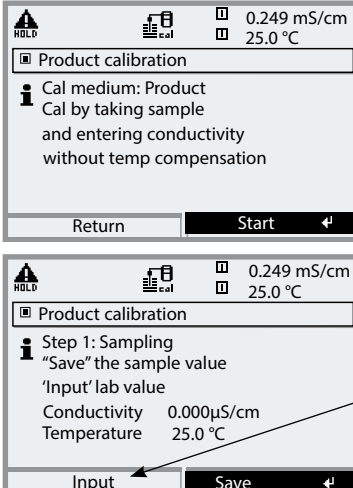
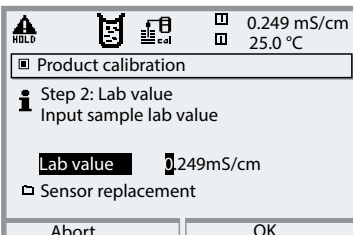
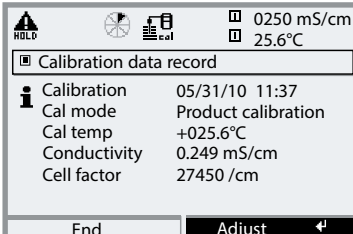
Menu	Display	Product calibration
	 <p>0.249 mS/cm 25.0 °C</p> <p>CONDI sensor</p> <ul style="list-style-type: none"> Automatic with standard cal solution Manual entry of cal solution Product calibration Data entry - premeasured sensor Zero correction <p>Return</p>	<p>Select calibration menu Select CONDI sensor</p> <p>Select calibration method: "Product calibration", confirm by pressing enter.</p>
	 <p>Product calibration</p> <p>Cal medium: Product Cal by taking sample and entering conductivity without temp compensation</p> <p>Return Start</p> <p>Product calibration</p> <p>Step 1: Sampling "Save" the sample value 'Input' lab value Conductivity 0.000µS/cm Temperature 25.0 °C</p> <p>Input Save</p>	<p>Step 1 Take sample. Save measured value and tem- perature at the moment of sampling ("Save" softkey or enter). The analyzer automatically returns to calibration mode selection. Press meas to return to measure- ment.</p> <p>Exception: Sample value can be measured on the site and be entered immediately. To do so, press "Input" softkey.</p>
	 <p>Product calibration</p> <p>Step 2: Lab value Input sample lab value</p> <p>Lab value 0.249mS/cm</p> <p>Sensor replacement</p> <p>Abort OK</p>	<p>Step 2 Lab value has been measured. When you open the Product calibration menu again, the display shown on the left appears: Enter reference value ("Lab value"). Confirm by pressing "OK" or repeat calibration.</p>
	 <p>Calibration data record</p> <p>Calibration 05/31/10 11:37 Cal mode Product calibration Cal temp +025.6°C Conductivity 0.249 mS/cm Cell factor 27450 /cm</p> <p>End Adjust</p>	<p>Adjustment Press "Adjust" to take over the values determined during calibration for calculating the measured variables.</p>

Calibration / Adjustment (CONDI)

Data Entry of Premeasured Sensors

Data Entry of Premeasured Sensors

Entry of cell factor and zero point of a sensor, related to 25°C, 1013 mbar.

During calibration the module is in HOLD mode.

Current outputs and relay contacts of the module behave as configured (Module BASE).

If **concentration measurement** is activated, this menu also shows the concentration value and directly adjusts it depending on the cell factor. This allows direct calibration of the concentration value.

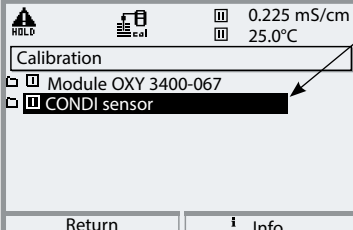
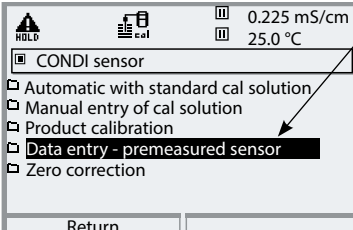
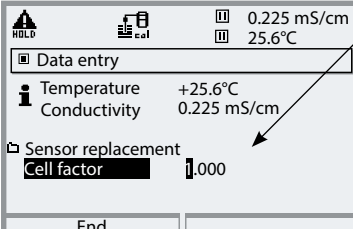
Menu	Display	Data entry of premeasured sensors
		<p>Select: CONDI sensor During calibration, the output currents (1 and 2), limit contacts, and controller output are in HOLD mode. Press enter to confirm.</p>
		<p>Select "Data entry" calibration method. Press enter to confirm.</p>
		<p>Enter cell factor of premeasured sensor Confirm by pressing "OK" or repeat calibration.</p>

Zero Correction (CONDI)

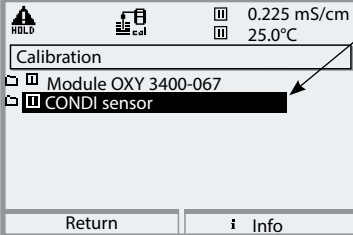
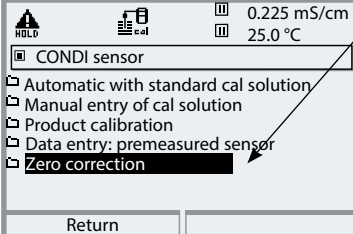
Menu	Display	Data entry of premeasured sensors
		<p>Select: CONDI sensor</p> <p>During calibration, the output currents (1 and 2), limit contacts, and controller output are in HOLD mode. Press enter to confirm.</p>
		<p>Select "Zero correction" calibration method. Press enter to confirm. The module is in HOLD mode. Permissible zero point deviation depends on the sensor type. For the SE 670, it is ± 0.050 mS/cm. Press Adjust to take over the calibration data.</p>

Calibrating the Sensors











Since the cell constant is subject to production-related variances, the dismantled sensor should be calibrated with a calibration solution (e.g. NaCl saturated).

- When mounted in restricted space (minimum distances not kept), the sensor must be calibrated when mounted since the resulting cell factor has changed. Calibration method: "Product calibration"

CONDI Maintenance



Sensor monitor / Temp probe adjustment

Note: HOLD mode active

Menu	Display	Maintenance
 maint	<div data-bbox="180 368 529 611">  0.245 mS/cm 25.6°C <p>Menu selection</p> <div style="display: flex; justify-content: space-around;">     </div> <p>Select: ◀ ▶ [enter]</p> <div style="display: flex; justify-content: space-between;"> Return to meas Lingua </div> </div> <div data-bbox="180 683 529 922">   0.245 mS/cm 25.6°C <p>Sensor monitor</p> <ul style="list-style-type: none"> Resistance (cf=1) 1.983 MOhm Conductance (cf=1) 0.504 µS RTD 1.067 kOhm Temperature 25.6 °C <p style="text-align: center;">Return</p> </div> <div data-bbox="180 930 529 1169">   83.3 %Air 25.6°C <p>Adjust temp probe</p> <ul style="list-style-type: none"> Enter measured process temp Active adjustment 04/23/10 13:23 Deviation 000.0 °C Temperature 25.6 °C Process temperature +0.25.6°C <div style="display: flex; justify-content: space-between;"> Abort OK </div> </div>	<p>From the measuring mode: Press menu key to select menu. Select maintenance using arrow keys, confirm by pressing enter. Passcode 2958 (To change passcode: Parameter setting/System control/Passcode entry) Then select "CONDI sensor".</p> <p>Sensor Monitor During maintenance, the sensor monitor allows validation of the sensor by immersing it in a known solution, for example, and checking the values measured.</p> <p>Temp Probe Adjustment Make sure that the process temperature is precisely measured using a calibrated reference thermometer (accuracy better than 0.1°C) when performing an adjustment. Adjustment without precise measurement might result in considerable deviations of the measured value display!</p>

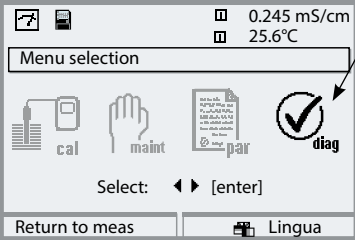

CONDI Diagnostics

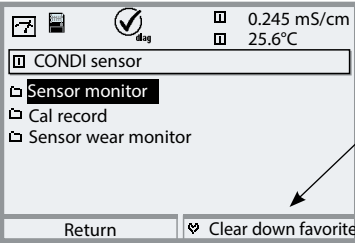
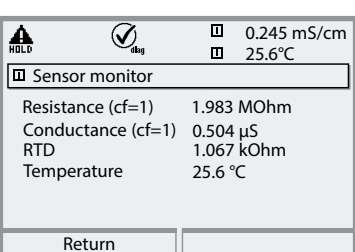
Sensor monitor

Menu	Display	Sensor monitor
		<p>Opening the diagnostics menu</p> <p>From the measuring mode: Press menu key to select menu. Select diagnostics using arrow keys, confirm by pressing enter. Then select CONDI sensor.</p>
		<p>The Diagnostics menu gives an overview of all diagnostics functions available. <u>Messages set as "Favorite"</u> can be called directly from the measuring mode using a softkey. Select: Parameter setting / System control / Function control matrix.</p>
		<p>Sensor Monitor</p> <p>Shows the values currently measured by the sensor. Important function for diagnostics and validation!</p>

Diagnostics (CONDI)

Cal Record

Menu	Display	Cal record
 diag	  0.245 mS/cm 25.6°C Cal record Active adjustment 06/09/10 14:06 Sensor model SE670 Serial number 0077123 Cal mode Prod. cal. Cell factor 6.2 Return	Cal Record Data of last calibration, suitable for documentation to ISO 9000 and GLP

Parameter Setting, General

Parameter setting/System control/Logbook

Note: HOLD mode

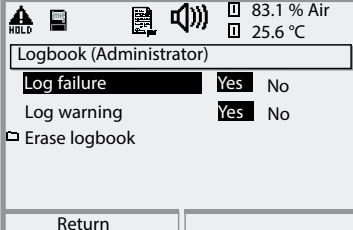
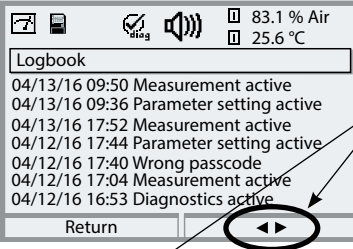
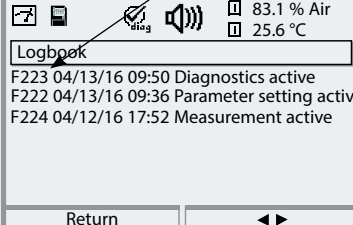
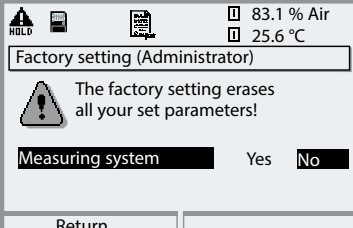
Menu	Display	Logbook, factory setting
		<p>Logbook</p> <p>Select which messages are to be logged in the logbook.</p> <p>The last 50 events are recorded with date and time.</p> <p>This permits quality management documentation to ISO 9000 et seq.</p>
		<p>The logbook can be called from the diagnostics menu (Fig.).</p> <p>Pressing the right softkey displays the message identifier.</p>
		<p>Additional Function SW 3400-104: Extended logbook for recording data on SmartMedia card (TAN).</p>
		<p>Factory Setting</p> <p>Allows resetting the parameters to their factory setting. When this menu is opened, the analyzer displays a warning (Fig.).</p>

Current Outputs, Contacts, OK Inputs

Select menu: Parameter setting/Module BASE

Note: HOLD mode active

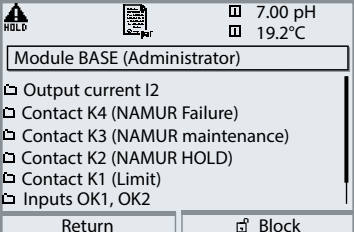
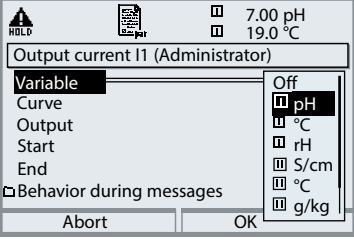
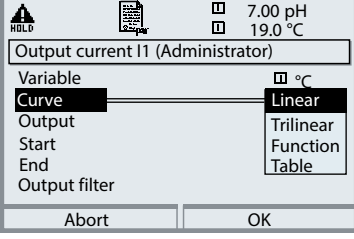
Menu	Display	Parameter setting BASE module
		<p>Configuring a Current Output</p> <ul style="list-style-type: none"> • Open parameter setting • Enter passcode • Select "Module BASE" • Select "Output current ..."
		<ul style="list-style-type: none"> • Select measured variable
		<ul style="list-style-type: none"> • Select Curve, e.g. "linear": The measured variable is represented by a linear output current curve. The desired range of the measured variable is specified by the values for "Start" and "End".

Assignment of Measured Values: Start (4 mA) and End (20 mA)

Example 1: Range pH 0 - 14

Example 2: Range pH 5 - 7

Advantage: Higher resolution in range of interest

Output current [mA]

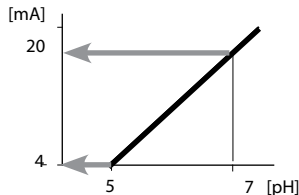
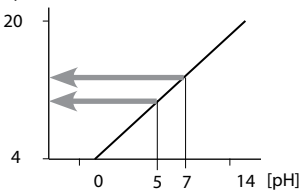

Current Outputs: Characteristics

Select menu: Parameter setting/Module BASE

- **Linear characteristic**

The process variable is represented by a linear output current curve.

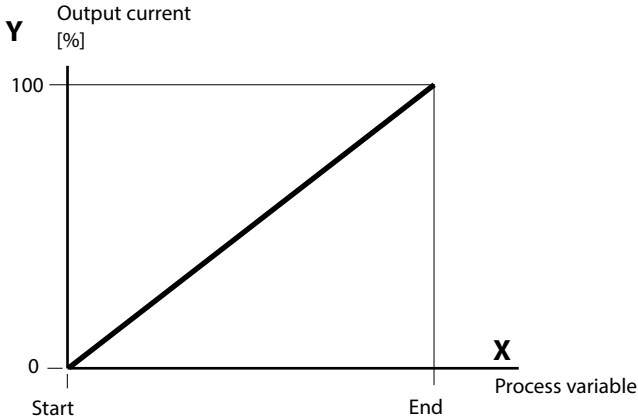

- **Trilinear characteristic**

Two additional vertices must be entered:

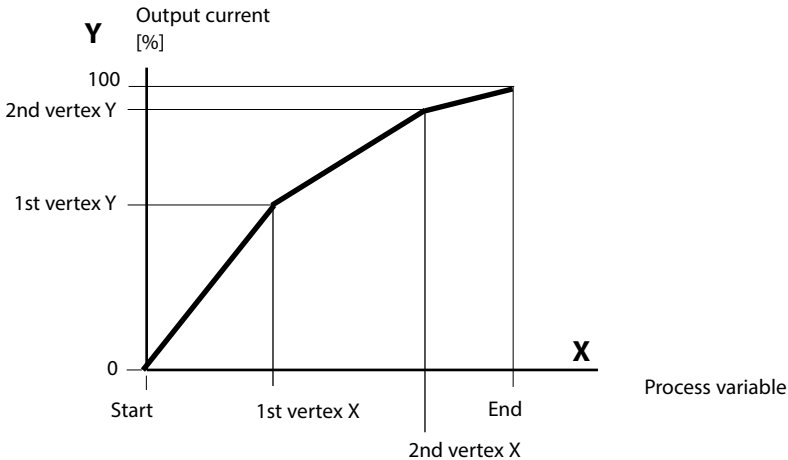

- **Note: Bilinear characteristic**

For a bilinear characteristic, identical parameters are entered for the two vertices (1st vertex, 2nd vertex).

• Function characteristic

Nonlinear output current characteristic: allows measurements over several decades, e.g. measuring very low values with a high resolution and high values with a low resolution.

Required: Entering a value for 50 % output current.

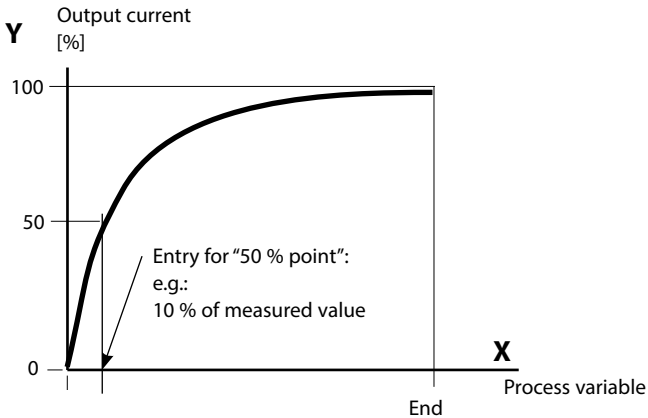

Equation

$$\text{Output current (4 to 20 mA)} = \frac{(1+K)x}{1+Kx} 16 \text{ mA} + 4 \text{ mA}$$

$$K = \frac{E + S - 2 * X50\%}{X50\% - S} \qquad x = \frac{M - S}{E - S}$$

- S: Start value at 4 mA
- X50%: 50% value at 12 mA (output current range 4 to 20 mA)
- E: End value at 20 mA
- M: Measured value

Logarithmic output curve over one decade:

- S: 10 % of maximum value
- X50%: 31.6 % of maximum value
- E: Maximum value

Logarithmic output curve over two decades:

- S: 1 % of maximum value
- X50%: 10 % of maximum value
- E: Maximum value

Output Filter

Time interval

Time averaging filter

To smoothen the current output, a low-pass filter with adjustable time interval can be switched on. When there is a jump at the input (100 %), the output level is at 63 % after the time interval has been reached.

The time interval can be set from 0 to 120 sec. If the time interval is set to 0 sec, the current output follows the input.

Note:

The filter only acts on the current output and the current value of the secondary display, not on the measurement display, the limit values or the controller!

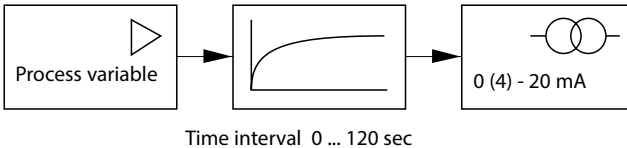

NAMUR Signals: Current Outputs

Behavior during messages: HOLD, 22mA signal

Behavior during messages

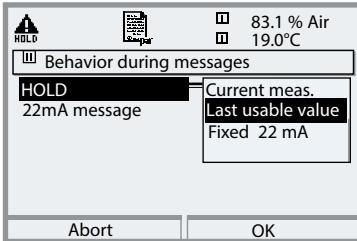

Depending on the configuration ("Messages") the current outputs switch to:

- Currently measured value
- Last measured value (HOLD function)
- Fixed value (22 mA)

In the case of a fault a 22 mA signal can be generated for the selected process variable (1st primary value).

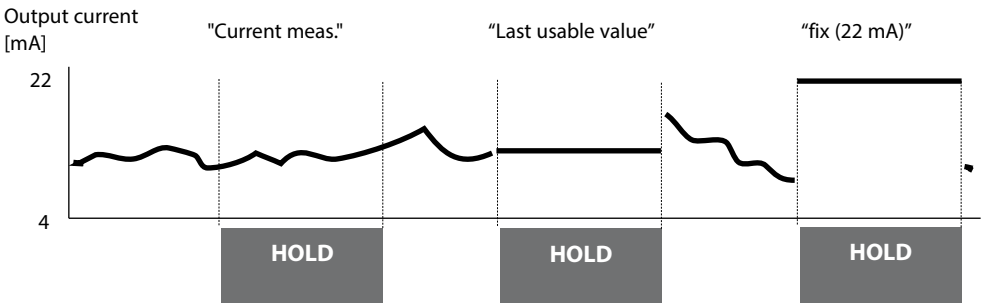

Message when the current range is exceeded

As delivered, the "Maintenance request" (Warn) message is generated when the current range is exceeded ($< 3.8 \text{ mA}$ or $> 20.5 \text{ mA}$).

This setting can be changed in the Parameter setting menu of the respective measuring module at "Messages".

To generate a "Failure" message, the limit value monitoring must be set to "Variable limits":

Parameter setting - <measuring module> - Messages - Variable limits - Failure limit ...

Enter the same values for the failure limits as for the current output:

Parameter setting - Module BASE - Output current - Variable Start / End.

NAMUR Signals: Relay Contacts

Failure, maintenance request, HOLD (function check)

As delivered, the floating relay outputs of the BASE module are assigned to the NAMUR signals:

Failure	Contact K4, normally closed (signaling current failure)
Maintenance request	Contact K3, normally open contact
HOLD	Contact K2, normally open contact

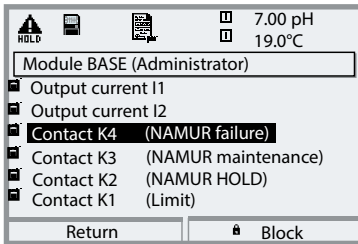

NAMUR signals: Factory setting of contacts

- Select parameter setting
 - Administrator level
 - Select "Module BASE" (Fig.)
- You can define a delay time for "Maintenance request" and "Failure", resp.
- If an alarm message is released, the contact will only be activated after expiry of this delay time.

Failure is active

when a value has exceeded (or fallen below, resp.) a preset "Failure Limit Hi" or "Failure Limit Lo", when the measured value is out of range, or in the event of other failure messages. That means that the equipment no longer operates properly or that process parameters have reached a critical value. Failure is disabled during "HOLD" (Function check).

Maintenance request is active

when a value has exceeded (or fallen below, resp.) a preset "Warning Limit Hi" or "Warning Limit Lo", or when other warning messages have been activated. That means that the equipment is still operating properly but should be serviced, or that process parameters have reached a value requiring intervention. Warning is disabled during "HOLD" (function check).

HOLD is active:

- during calibration
- during maintenance (current source, meas. point maintenance)
- during parameter setting at the Operator level and the Administrator level
- during an automatic rinsing cycle

Relay Contacts: Protective Wiring

Protective wiring of relay contacts

Relay contacts are subject to electrical erosion. Especially with inductive and capacitive loads, the service life of the contacts will be reduced. For suppression of sparks and arcing, components such as RC combinations, nonlinear resistors, series resistors and diodes should be used.

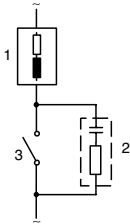
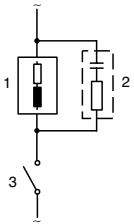

Typical AC applications with inductive load

- 1 Load
 - 2 RC combination, e.g. RIFA PMR 209
- Typical RC combinations
e.g.
capacitor 0.1 μ F
resistor 100 ohms / 1 W
- 3 Contact

Caution!

Make sure that the maximum ratings of the relay contacts are not exceeded even during switching!

Information concerning relay contacts

As delivered, the relay contacts are suitable for low signal currents (down to approx. 1 mA). If currents above approx. 100 mA are switched, the gold plating is destroyed during the switching process. After that, the contacts will not reliably switch low currents.

Relay Contacts

Parameter setting/Module BASE/Relay contacts

Menu	Display	Setting the relay contacts
		Relay contacts, usage <ul style="list-style-type: none"> • Open parameter setting • Enter passcode • Select "Module BASE" • Select "Contact ..." • "Usage" (Fig.)

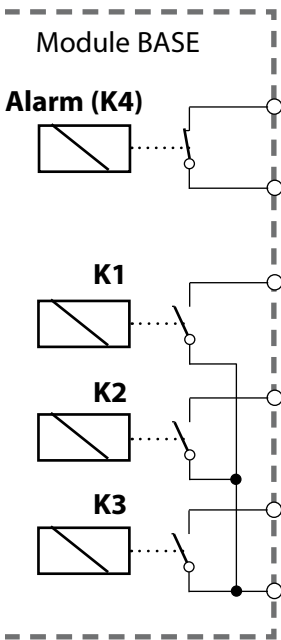

Contact assignment:
See terminal plate of
BASE module

The BASE module provides 4 relay contacts (max. AC/DC rating 30 V / 3 A each). Contact K4 is provided for failure message. The switching behavior (normally open or normally closed), as well as a switch-on or switch-off delay can be defined.

Default settings of the user-definable relay contacts of the BASE module:

- K3: NAMUR maintenance request
- K2: NAMUR HOLD (function check)
- K1: Limit value

K1-K3 are user definable ("Usage"):

- NAMUR maintenance
- NAMUR HOLD
- Limit value
- Rinse contact
- Parameter set B active
- USP output (COND module only)
- K1 rec. active
- Sensoface
- Alarm control

Relay Contacts: Sensoface Messages

Parameter setting/Module BASE/Relay contacts/Usage/Sensoface

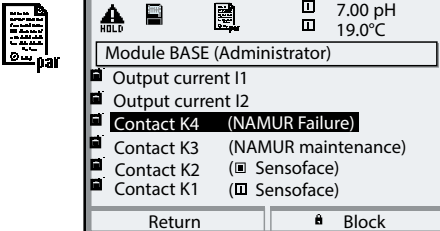
Menu	Display	Parameter setting (Sensoface)
	<p>Module BASE (Administrator)</p> <ul style="list-style-type: none"> Output current I1 Output current I2 Contact K4 (NAMUR Failure) Contact K3 (NAMUR maintenance) Contact K2 (<input checked="" type="checkbox"/> Sensoface) Contact K1 (<input checked="" type="checkbox"/> Sensoface) <p>Return Block</p>	<p>Assign Sensoface messages to relay contacts</p> <p>When more than one measuring module is used, the Sensoface messages of the modules can be assigned to different contacts.</p>
	<p>Contact K1 (Administrator)</p> <p>Usage</p> <ul style="list-style-type: none"> Variable: NAMUR maintenance Limit value: NAMUR HOLD Hysteresis: Limit value Effective direction: <input checked="" type="checkbox"/> Sensoface Contact type: Parameter set B active USP output <p>Return</p>	<p>Relay contacts, usage</p> <ul style="list-style-type: none"> • Open parameter setting • Enter passcode • Select "Module BASE" • Select contact e.g. K1) • Assign Sensoface message of desired measuring module to selected relay contact
	<p>Contact K1 (Administrator)</p> <p>Usage <input checked="" type="checkbox"/> Sensoface</p> <ul style="list-style-type: none"> Contact type: <input checked="" type="checkbox"/> N/O ON delay: 0010 s OFF delay: 0010 s <p>Return</p>	<p>Set contact parameters</p> <ul style="list-style-type: none"> • (e.g. "N/O") • Set ON / OFF delay.

Rinse Contact

Parameter setting/Module BASE/Relay contacts/Usage/Rinse contact

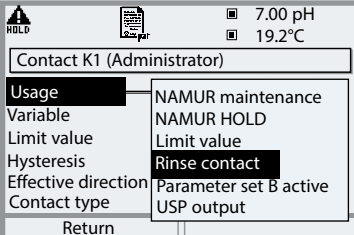
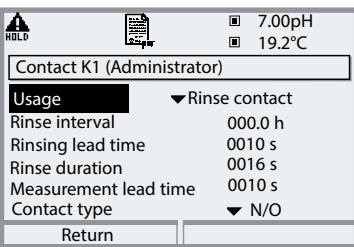
Menu	Display	Configuring the rinse contact
		<p>Relay contacts, usage</p> <ul style="list-style-type: none"> • Open parameter setting • Enter passcode • Select "Module BASE" • Select contact e.g. K1) • "Rinse contact" (Fig.)
		<p>Set rinse contact parameters</p> <ul style="list-style-type: none"> • Set rinse interval • Set rinse duration • During the defined "lead time" the "HOLD" mode is active. • Select contact type (e.g. "N/O")

Please note when configuring the "Rinse contact" function

- "HOLD" mode (e.g. during parameter setting) delays the execution of the "Rinse contact" function.
- Up to 3 rinse functions (contacts K1 ... K3) can be configured independently.
- The individual rinse functions are not synchronized with each other.

Time response

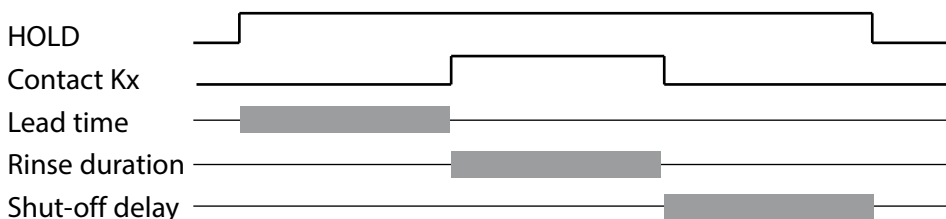

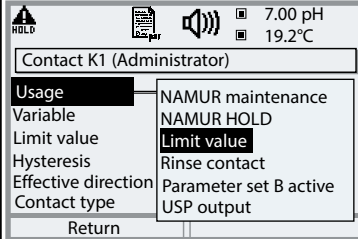

Limit Value, Hysteresis, Contact Type

Parameter setting/Module BASE/Relay contacts/Usage

Menu	Display	Usage as limit value
		Relay output: Limit value <ul style="list-style-type: none"> • Open parameter setting • Enter passcode • Select "Module BASE" • Select "Contact ..." • "Usage: Limit" (Fig.)

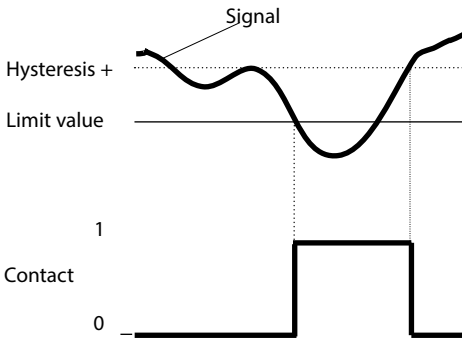
Limit value 
Effective direction min



Limit value 
Effective direction max

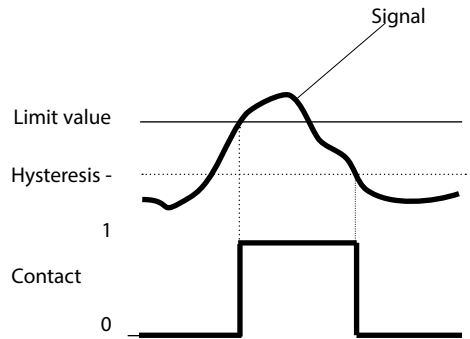

Icons in the measurement display

Measured value exceeds limit: 

Measured value falls below limit: 

Hysteresis

Tolerance band around the limit value, within which the contact is not actuated. Serves to obtain appropriate switching behavior at the output and suppress slight fluctuations of the measured variable (Fig.)

Contact type

Specifies whether the active contact is closed (N/O) or open (N/C).

OK1, OK2 Inputs: Specify Level

Parameter setting/Module BASE/Inputs OK1, OK2

Note: HOLD mode (Setting: BASE module)

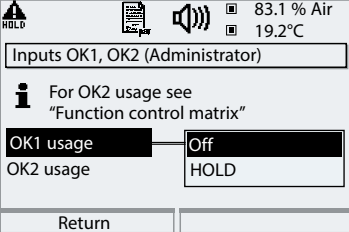
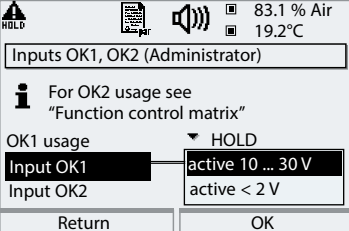
Menu	Display	Setting the OK inputs
		<p>OK1 usage</p> <ul style="list-style-type: none"> • Open parameter setting • Enter passcode • Select "Module BASE" • Select "Inputs OK1/OK2" • Select "OK1 usage"
		<p>OK1/OK2 switching level</p> <ul style="list-style-type: none"> • Open parameter setting • Enter passcode • Select "Module BASE" • Select "Inputs OK1/OK2" • Specify active switching level

The BASE module provides 2 digital inputs (OK1, OK2). The following functions (depending on the parameter setting) can be started via a control signal:

- OK1: "Off" or "HOLD"
- OK2: Select: System control / Function control matrix. ("Off", "Parameter set A/B", "Start KI recorder")

You must specify the switching level for the control signal:
(active 10...30 V or active < 2 V).

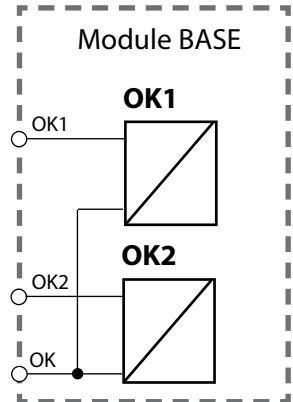

Switching Parameter Sets via OK2

Parameter setting / System control / Function control matrix

Note: HOLD mode (Setting: BASE module)

Parameter Sets

2 complete parameter sets (A, B) can be stored in the analyzer.

You can switch between the parameter sets using the OK2 input.

The currently activated set can be signaled by a relay contact.

An icon in the measurement display shows which parameter set is active:

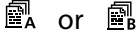

Menu	Display	Parameter sets
		Selecting Parameter Set (A, B) via OK2 Input <ul style="list-style-type: none"> • Open parameter setting • System control • Function control matrix • Select "OK2" • Connect "Parameter set A/B"
		Signaling Active Parameter Set via Relay Contact <ul style="list-style-type: none"> • Open parameter setting • BASE module • Select contact • Usage: "Parameter set ..."

Note

The selection has no effect when working on SmartMedia card with SW 3400-102.

Overview of the System Components

Probe Control

The fully automated process analysis system consists of the following components

- Protos 3400 (modular process analysis system)
- Unical 9000/Uniclean 900 (automatic control of retractable probes)
- Ceramat WA 150 (sensor lock-gate with ceramic sealing to the process) or SensoGate WA 130

The system is operated from the Protos 3400. Four operating modes are provided: calibration, parameter setting, maintenance, diagnostics.

The FIU 3400-141 module consists of 2 functional groups:

- measuring circuit
- probe control

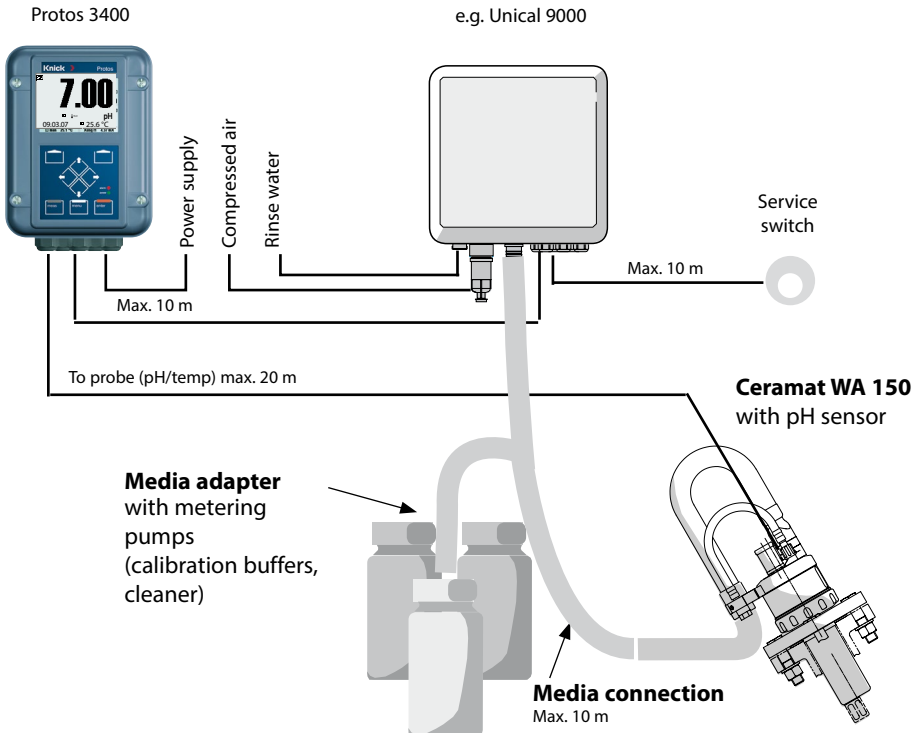

Overview of the System Components

Protos 3400 basic unit and FIU 3400-141 controller module for sensor lock-gates and Unical 9000 / Uniclean 900 probe controller

Protos 3400 basic unit. The FIU 3400-141 module is located in one of the module slots.

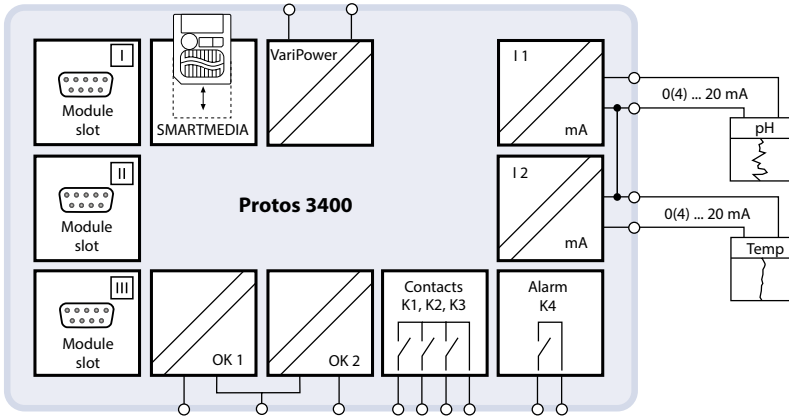

FIU 3400-141 controller module for sensor lock-gates and Unical 9000 / Uniclean 900 probe controllers:

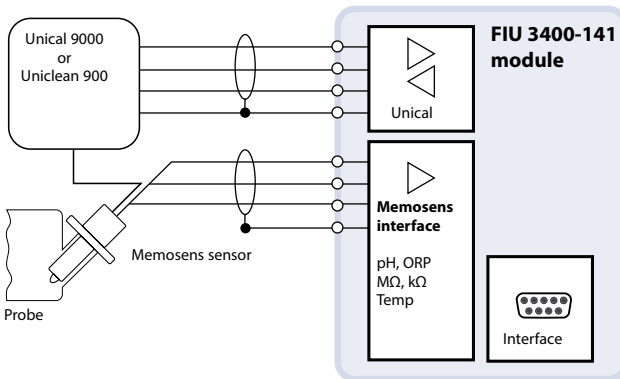

Probe Control via FIU 3400-141 Module

Measuring Circuit and Probe Control Function Blocks

For a direct access to the function descriptions related to the Unical 9000 / Uniclean 900 probe controllers, please refer to the overview on the back page of this manual.

You can document your specific settings for the Unical 9000 / Uniclean 900 probe controllers in the Excel spreadsheet from the CD-ROM (supplied with Protos 3400(X)).

Measuring Circuit and Probe Control Function Blocks

Probe Control

Through an RS-485 interface the FIU 3400-141 module allows actuating the Unical 9000 probe controller for fully automated pH measurement, cleaning, and calibration or the Uniclean 900 probe controller for fully automated pH measurement and cleaning.

Measuring Circuit

The FIU 3400-141 module provides two RS-485 interfaces for connecting digital sensors (Memosens).

This manual describes the whole functionality of the FIU 3400-141 module corresponding to the following menu groups:

- Calibration
- Maintenance
- Parameter setting
- Diagnostics

The Protos 3400(X) is an expandable modular process analysis system.
Latest product information: www.knick.de

Connection of Probe Controller

Probe Controller for Fully Automated Measurement, Cleaning, and Calibration

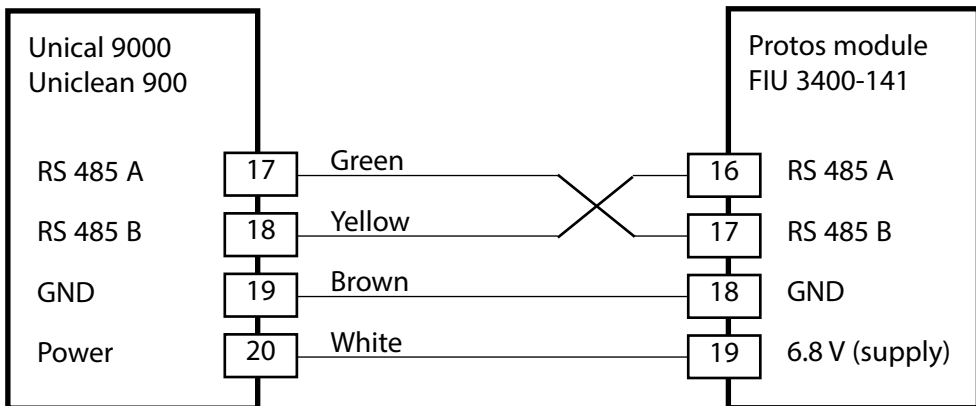

Unical 9000 / Uniclean 900 Probe Controllers

The Unical 9000 / Uniclean 900 probe controllers come with installation manuals, free download at www.knick.de.

Parameter Setting: Operating Modes

Parameter setting: Specifying the operating mode.

Note: HOLD mode active

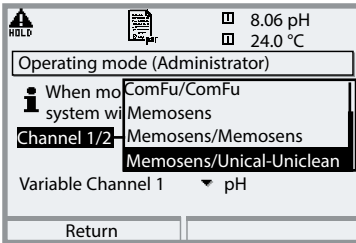
Menu	Display	Parameter setting
		<p>Select Operating Mode Select operating mode using arrow keys, confirm by pressing enter.</p> <p>To take over the new settings, the analyzer will restart.</p>

Thanks to the “Plug & Measure” method, a connected Memosens sensor is displayed immediately after the restart:

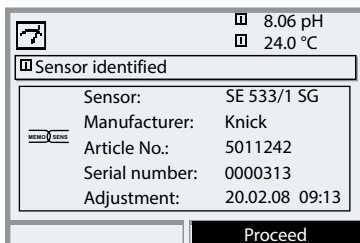

All sensor-typical parameters are automatically sent to the analyzer.

These are, for example, the measurement range, zero and slope of the sensor, but also the type of temperature probe. Without any further parameter setting, measurement starts at once, the measuring temperature is simultaneously detected.

With “Plug&Measure”, premeasured Memosens sensors can immediately be used for measurement without previous calibration.

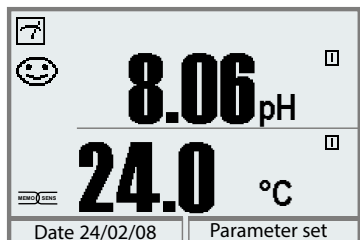

The Memosens icon is displayed as long as a Memosens sensor is connected.

"Memosens/Unical-Uniclean" Mode

Parameter setting: Measuring circuit and probe control.

Note: HOLD mode active.

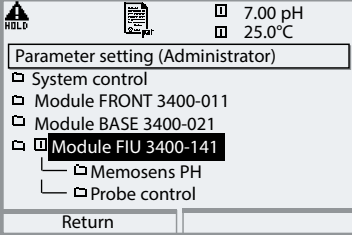
Menu	Display	Parameter setting
		<p>After initialization of the "FIU 3400-141" module (see previous page), the analyzer automatically restarts, identifies the connected sensor (Memosens) and the connected probe controller (Unical, Uniclean).</p> <p>All parameters related to the measuring circuit (i.e. the sensor) are comprised in "Memosens PH".</p> <p>The parameters required for probe control are comprised in "Probe control".</p>

Configuring the Unical 9000 Probe Controller

Functional Capabilities

Setting	Adjustable parameters	Page
<ul style="list-style-type: none"> Control Cal preset values Cal Buffer 1 Cal Buffer 2 Cal mode Cal timer program 	<p>Off, Unical 9000, Unclean 900</p> <p>Buffer set as configured</p> <p>Calimatic (automatic) or selection of a buffer</p> <p>Calimatic (automatic) or selection of a buffer</p> <p>Adjustment, Calibration</p> <p>Starts the selected program after cal timer expiry</p>	Pg 178
<ul style="list-style-type: none"> Time control 	<p>Fixed interval, Week program:</p> <p>Fixed interval: Select program, interval</p> <p>Week program: Configuration of program flows</p>	Pg 179
<ul style="list-style-type: none"> Program flow 	Individual adaptation of program steps for: Cleaning, Cal 2point, Cal 1point, Service, Parking, User 2, User 1	Pg 180
<ul style="list-style-type: none"> Installation External control (DCS) 	<p>On, Off</p> <p>DCS inputs (36...39) active 10...30 V or active < 2 V</p> <p>M/S input (42/43) active 10...30 V or active < 2 V</p> <p>A/M input (40/41) active 10...30 V or active < 2 V</p> <p>Output DCS 34 Measuring, Alarm</p> <p>DCS outputs (31...34) N/O, N/C</p>	<p>Pg 191</p> <p>Pg 192</p>
<ul style="list-style-type: none"> Sensor detection 	On, Off	
<ul style="list-style-type: none"> Access manual control 	Access code required. All valves can be actuated separately.	
<ul style="list-style-type: none"> Probe Move time max. Sealing water Cavity rinsing Check interval Maintenance interval 	<p>Probe type (Ceramatic, SensoGate, InTrac, others)</p> <p>Adjustable; default setting 0015 s</p> <p>On, Off</p> <p>Off, Interval, Continuous</p> <p>On, Off (On: Entry: Check after x travels)</p> <p>On, Off (On: Entry: Maintenance after x travels)</p>	
<ul style="list-style-type: none"> Rinse water 	Monitoring: Off , Process value, Temperature	
<ul style="list-style-type: none"> Media adapter (I ... III) (up to 3 pumps) 	Each: Medium, Displaced volume, Residual volume, Monitoring of medium (Off / Process value / Temperature)	
<ul style="list-style-type: none"> Add. media (1 ... 2) 	Monitoring of medium (Off, Process value, Temperature)	
<ul style="list-style-type: none"> Start-up 	Yes, No	Pg 197
<ul style="list-style-type: none"> System forecast 	On, Off	Pg 198

Menu	Display	Unical 9000 parameter setting
		<h3>Access Parameter Setting</h3> <p>From the measuring mode: Press menu key to select menu. Select parameter setting using arrow keys, press enter to confirm.</p>
		<h3>Select Probe Controller</h3> <p>(FIU_Unical/Uniclean) Icons to assign the measured values displayed:</p> <ul style="list-style-type: none"> <input type="checkbox"/> specifies module slot I <input type="checkbox"/> specifies module slot II <h3>Cal Presetting for Unical 9000</h3> <ul style="list-style-type: none"> • Select measuring module: Select the pH module for evaluation with the Unical 9000 controller (only if equipped with more than 1 pH module). <h3>Select Cal Mode</h3> <ul style="list-style-type: none"> • Adjustment: The values determined by a calibration are taken over. • Calibration: The values determined by a calibration are logged, but not taken over. <h3>Cal Timer Program</h3> <p>Starts the selected program after cal timer expiry.</p>
		<h3>Time Control</h3> <ul style="list-style-type: none"> • Fixed interval (3): Specify times (000.0 h ... xxx.x h) (Please note: 000.1 h = 6 min) • Week program: Specify weekday

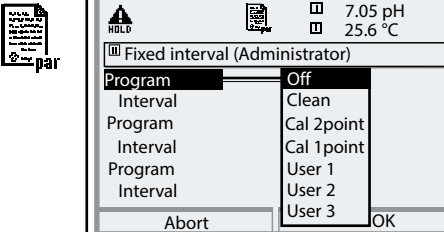
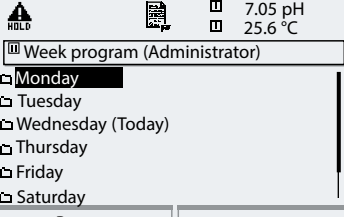
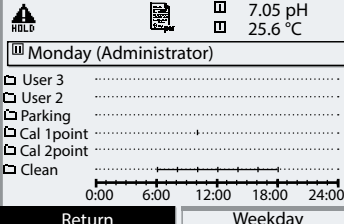
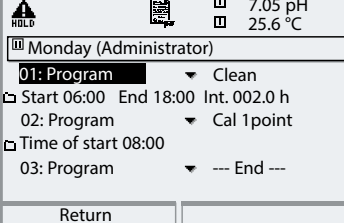
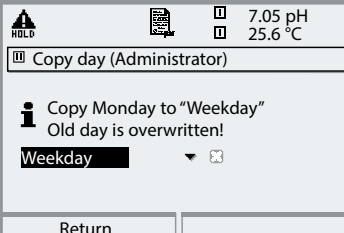
Menu	Display	Configuring the time control
	<p>Time Control: Fixed Interval</p> <p>The “Fixed interval” menu allows selection of up to three programs. An individual time interval can be assigned to each program.</p>	
		<p>Time Control: Week Program</p> <p>In this menu you can View, Edit and Copy.</p>
		<p>View</p> <p>shows the configured program sequences over the day</p>
		<p>Edit</p> <p>allows selection of up to 10 programs per day and you can choose between “Individual start” or “Interval” (the program is executed within a start and an end time at a specified interval).</p>
		<p>Copy</p> <p>allows taking over a configured program for another weekday. (Further editing is possible.)</p>

Parameter Setting: Program Flows

Cleaning (continuous), Media monitoring off

Display text	Time [s]
01: Probe in SERVICE	
02: Cleaning agent	0020 s
03: Rinse water ON	0060 s
04: Rinse water Off	0002 s
05: Probe in MEASURE	0005 s
06: Prog. end	

Cleaning (continuous) can also be started via a DCS input signal at BIN1 input of the Unical 9000 probe controller.

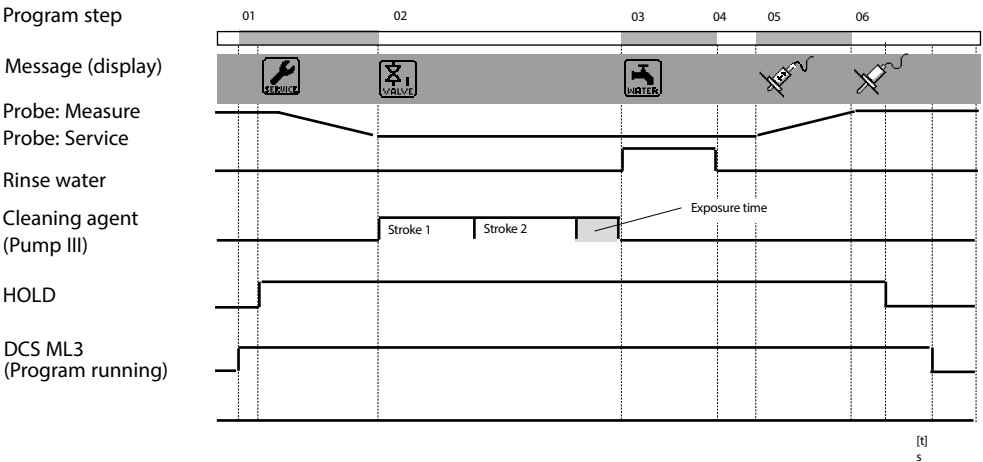

Parameter Setting: Program Flows

Cal 2point (continuous), Media monitoring off

Display text	Time [s]
01: Probe in SERVICE	
02: Cleaning agent	0020 s
03: Rinse water ON	0060 s
04: Rinse water Off	0002 s
05: Buffer I	0000 s
06: Cal Buffer 1	
07: Rinse water ON	0010 s
08: Rinse water Off	0002 s
09: Buffer II	0000 s
10: Cal Buffer 2	
11: Rinse water ON	0010 s
12: Rinse water Off	0002 s
13: Probe in MEASURE	0005 s
14: Prog. end	

Cal 2point (continuous) can also be started via a DCS input signal at BIN2 input of the Unical 9000 probe controller.

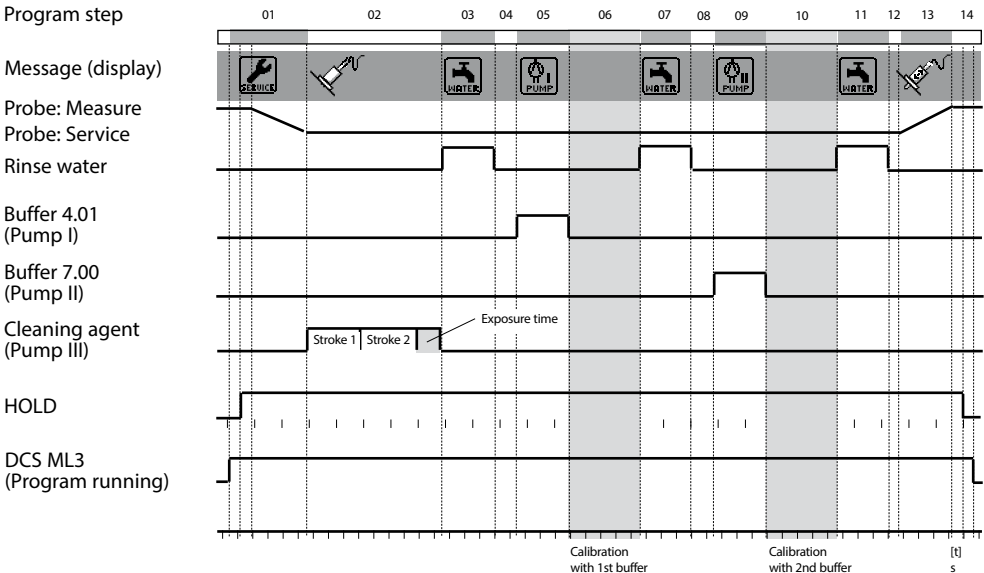

Parameter Setting: Program Flows

Cal 1 point (continuous), Media monitoring off

Display text	Time [s]
01: Probe in SERVICE	
02: Cleaning agent	0003 s
03: Rinse water	0010 s
04: Rinse water	0002 s
05: Buffer I	0000 s
06: Cal buffer 1 (pH 4.01)	
07: Rinse water	0010 s
08: Rinse water	0002 s
09: Probe in MEASURE	
10: Prog. end	

Program step

Message (display)

Probe: Measure

Probe: Service

Rinse water

Buffer 4.01
(Pump I)

Cleaning agent
(Pump II)

HOLD

DCS ML3
(Program running)

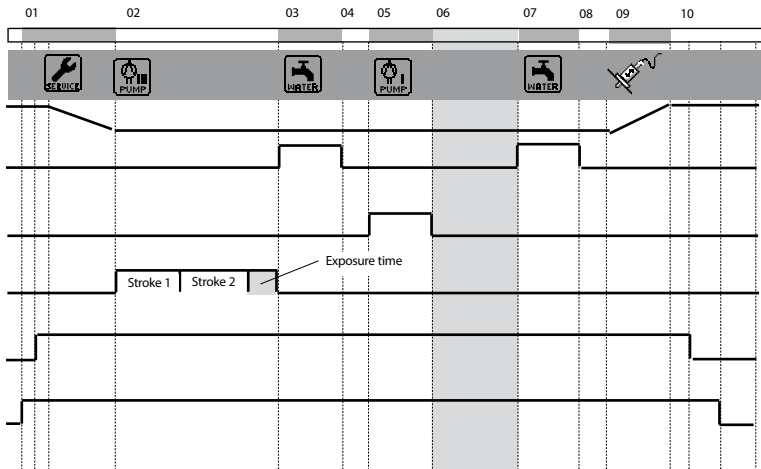

Calibration with
1st buffer

[t]
s

Park Program: Wait Position

The park program includes the programming step “Wait position”. When the program is started via the DCS inputs BIN 1 ... BIN 3 on the Unical 9000, the program will be executed until the “Wait position” is reached. There it remains until the signal status at the DCS inputs changes.

- The program is started via the DCS inputs and remains in “Wait position” until the assignment of the DCS inputs changes:

DCS inputs BIN 1 ... BIN 3
of Unical 9000



- The program is started by a short signal at the DCS inputs: Wait position is skipped.

DCS inputs BIN 1 ... BIN 3
of Unical 9000

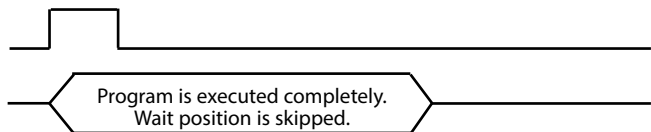

Please note:

If the programs are started by the Protos 3400(X) from the Calibration or Maintenance menu, the wait position will be skipped.

Parameter Setting: Program Flows

Parking

Display text	Time [s]
01: Probe in SERVICE	
02: Cleaning agent	0020 s
03: Rinse water ON	0060 s
04: Rinse water Off	0002 s
05: Purge air ON	0010 s
06: Purge air OFF	0002 s
07: Cal buffer 1 (pH 4.01)	
08: Wait position	> Position will be held until next command (e.g. DCS)
09: Rinse water ON	0010 s
10: Rinse water Off	0002 s
11: Probe in MEASURE	0005 s
12: Prog. end	

Parking is started via a DCS input signal at BIN3 input of the Unical 9000 probe controller.

Program step

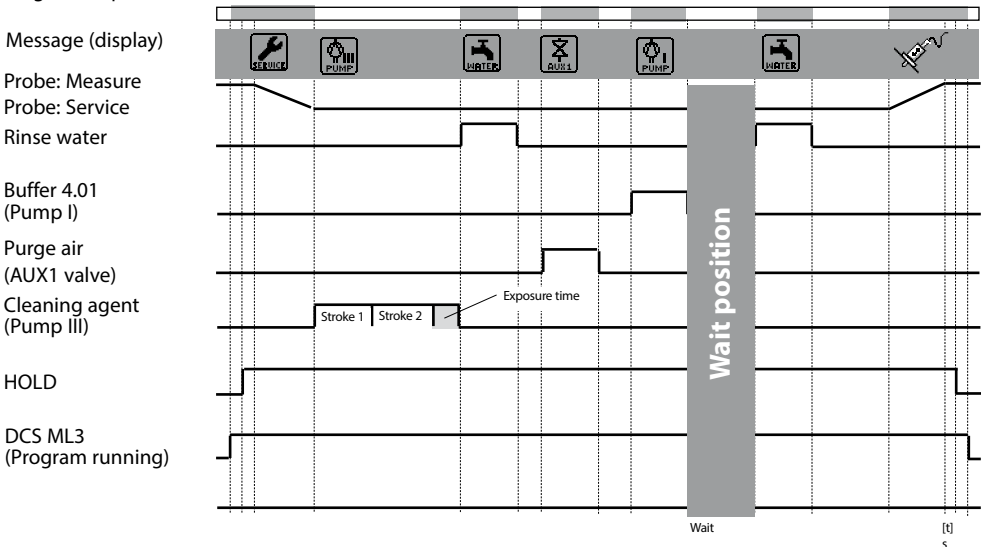

Parameter Setting: Program Flows

Measurement (short-time), Media monitoring off

Display text	Time [s]
01: Rinse water ON	0010 s
02: Rinse water Off	0002 s
03: Probe in MEASURE	0005 s
04: Meas duration	0030 s
05: Probe in SERVICE	
06: Cleaning agent	0020 s
07: Rinse water ON	0060 s
08: Rinse water Off	0002 s
09: Prog. end	

Measurement (short-time) can also be started via a DCS input signal at BIN1 input of the Unical 9000 probe controller.

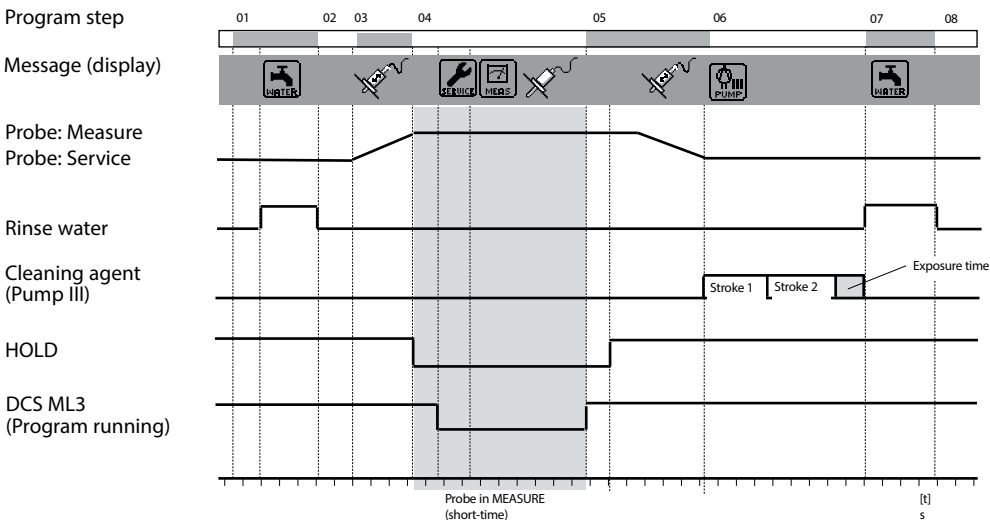

Parameter Setting: Program Flows

Cal 2point (short-time), Media monitoring off

Display text	Time [s]
01: Rinse water ON	0010 s
02: Rinse water Off	0002 s
03: Buffer I	0000 s
04: Cal Buffer 1	
05: Rinse water ON	0010 s
06: Rinse water Off	0002 s
07: Buffer II	0000 s
08: Cal Buffer 2	
09: Rinse water ON	0010 s
10: Rinse water Off	0002 s
11: Prog. end	

Cal 2point (short-time) can also be started via a DCS input signal at BIN2 input of the Unical 9000 probe controller.

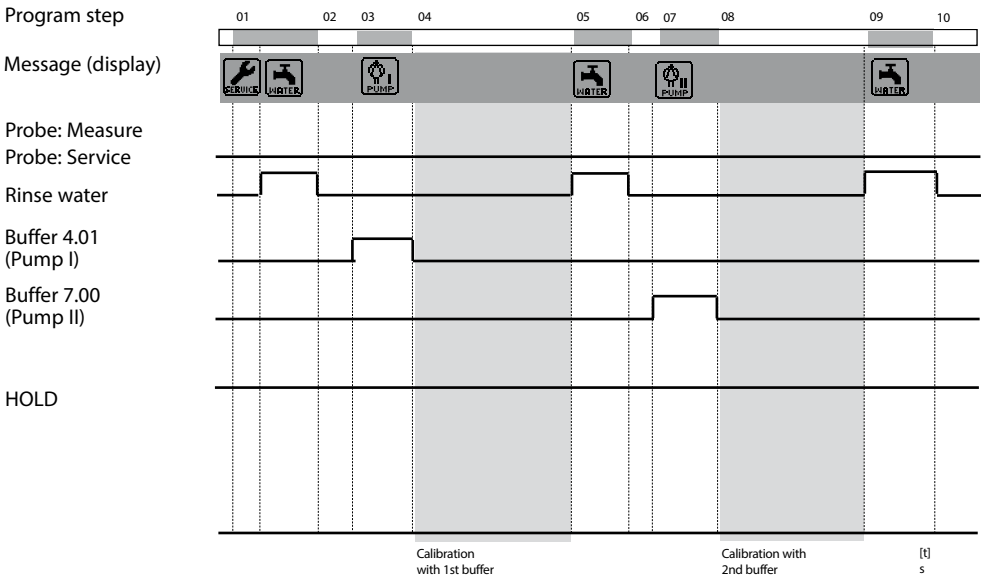

Parameter Setting: Program Flows

Cal 1 point (short-time), Media monitoring off

Display text	Time [s]
01: Rinse water ON	0010 s
02: Rinse water Off	0002 s
03: Buffer I	0000 s
04: Cal buffer 1 (pH 4.01)	
05: Rinse water ON	0010 s
06: Rinse water Off	0002 s
07: Prog. end	

Cal 1 point (short-time)

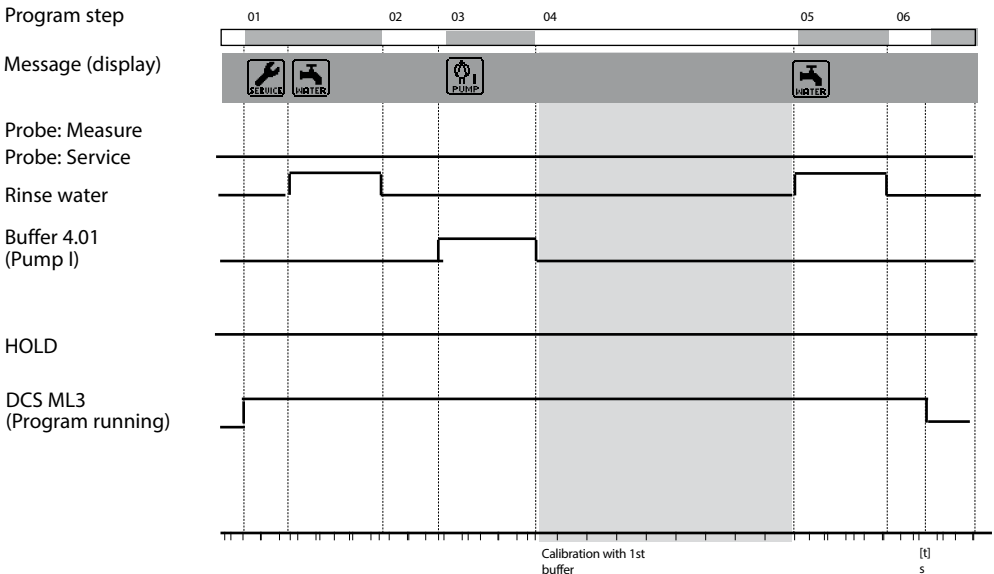



Parameter Setting: Program Flows

Service

Display text	Time [s]	
01: Probe in SERVICE		
02: Cleaning agent	0020 s	Measure -> Service
03: Rinse water ON	0060 s	
04: Rinse water Off	0002 s	
05: Purge air ON	0005 s	
06: Purge air OFF	0002 s	
07: Wait position		Service position
08: Rinse water ON	0010 s	
09: Rinse water Off	0002 s	
10: Probe in MEASURE	0005 s	Service -> Measuring
11: Prog. end		

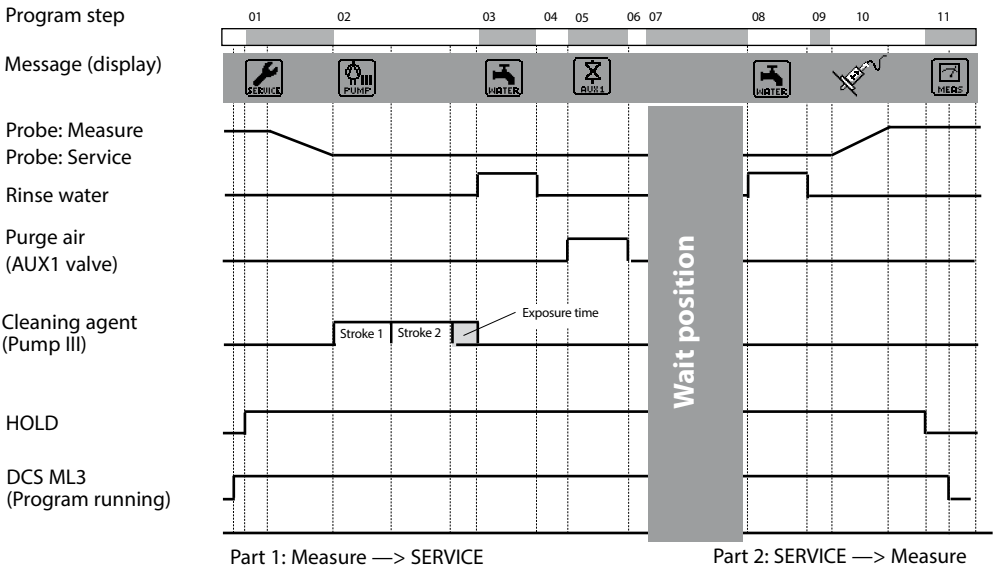
Service can also be started via a DCS input signal at M/S input of the Unical 9000 probe controller.

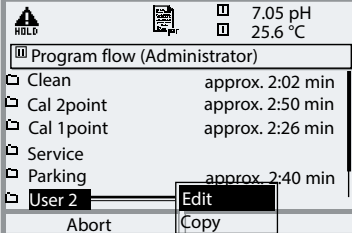
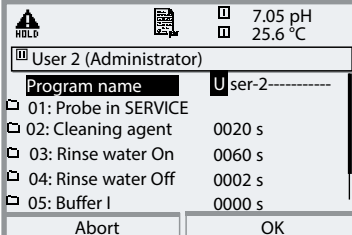
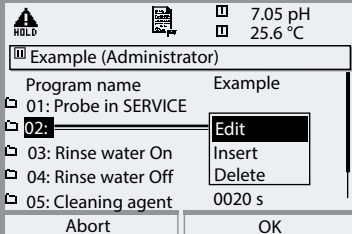

Menu	Display	Parameter setting Program flow
		<p>Configure Program Flow Parameter setting / Probe control / Program flow / User 2: Select "Edit" using arrow keys, confirm by pressing enter.</p>
		<p>Enter Program Name A new program name can be entered using the arrow keys. Confirm the name with enter</p>
		<p>Edit Program Step Select the program step you want to edit using the arrow keys. Press enter: Now you can choose between "Edit, Insert, Delete".</p> <ul style="list-style-type: none"> • Edit: Allows selecting a function • Insert: Inserts an empty step above the selected program step and then allows selecting a function by "editing" the empty step. • Delete: The program step is deleted.

Menu	Display	<ul style="list-style-type: none"> • Configure function • Activate monitoring
------	---------	---

For valve functions the run time must be specified, for pumps the exposure time.

Configure Function

Select a function using arrow keys, confirm with **enter**.

- Functions:
 - Program end
 - Probe in SERVICE
 - Probe in MEASURE
 - Rinse water On
 - Rinse water Off
 - Wait time
 - Buffer I - - Text can be edited during installation
 - Buffer II - - Text can be edited during installation
 - Cleaning agent - Text can be edited during install.
 - Cal Buffer 1
 - Cal Buffer 2
 - Purge air On -- Text can be edited during install.
 - Purge air Off -- Text can be edited during install.
 - Aux medium On - Text can be edited during install.
 - Aux medium Off - Text can be edited during install.

Activate Monitoring

(see "Media monitoring")

With several functions you can monitor the media used in the calibration chamber ("Monitoring: On") (e.g. cleaning agent, buffers, rinsing water, ...)

The respective program step is then marked with "Chk".

In any case it is necessary that you select the monitoring function for the respective medium in the "Installation" menu and specify valid tolerance limits for temperature or process value, otherwise the respective line is not displayed.

Parameter Setting: Installation

Installation	Default setting	Adjustable parameters
• Measurement procedure	Continuous	(short-time)
• Ext. control (DCS)		(Polarity / Output settings)
- Signal level of inputs DCS (36 ... 39) M/S (42, 43) A/M (40, 41)	Active: 10 ... 30 V	(Active: 10 ... 30 V / active < 2V)
- DCS output (34)	Measure	Alarm
- Signal level of inputs DCS (31 ... 34)	N/O	(N/O / N/C)
• Sensor detection	Off	On
• Access manual control	Access code for manual control (Maintenance menu) Default: 2958	
• Probe		
- Probe type	Ceramat	(SensoGate, InTrac / Other)
- Max. move time	0015 s	
- Safety valve	No	(Yes)
- Sealing water	Off	(On)
- Cavity rinsing	Off	(Off, Interval, Continuous)
- Interval	0001.0 h	
- Rinse duration	05 s	
- Check interval	0000 (Off)	(max. 20,000 probe travels)
- Maintenance interval	0000 (Off)	(max. 100,000 probe travels)
• Rinse water		
- Monitoring	Off	(Process value/Temperature)
- Setpoint	+07.00 pH	
- Adm. deviation	01.00 pH	
• Media adapter		
- Port I ... III	Off*	"Pump" or "Off"
- Medium:	---	(e.g. "Buffer I")
- Displaced volume	25 ml	(50 / 75 / 100 ml)
- Residual volume	250 ml	(0 / 250 / 500 ml)
- Monitoring	Off	(Process value/Temperature)
- Setpoint	07.00 pH	(Process medium or temp)
- Adm. deviation	0.50 pH	
• Additional media		
- Additional medium 1	Off	(On - with monitoring)
- Additional medium 2	Off	(On - with monitoring)
• Start-up	No	Yes/No
• System forecast	Off	Off / On: Monitors the probe travels for predictive maintenance of Ceramat und SensoGate

*Automatic adjustment by "Plug & Play" in: System control / Factory setting Unical

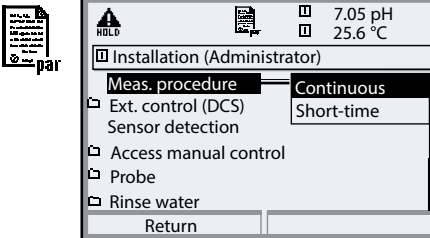
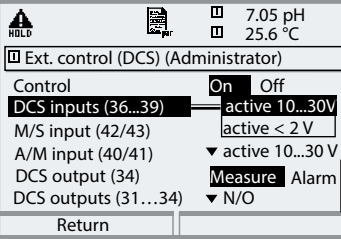
Menu	Display	<ul style="list-style-type: none"> • Meas. procedure • External control via DCS
		<p>Select Measurement Procedure</p> <ul style="list-style-type: none"> • Continuous measurement: With continuous measurement the pH electrode is located in the process medium and is retracted for calibration or cleaning. • Short-time measurement: (interval measurement, sampling, sample mode ...) The pH electrode is only momentarily moved into the process medium. This method is applied when measuring aggressive or thermally demanding process media which require short measurement times with long rest periods.
		<p>External Control via DCS</p> <ul style="list-style-type: none"> • DCS inputs: Inputs for selecting the control programs. Here, the active signal level is specified (< 2 V or 10 ... 30 V). • M/S input: Control of probe movement • A/M input: Intervals automatic / blocked • DCS output (34): Specify output signal for terminal 34: - Measure or - Alarm • DCS outputs (31 ... 34): Specify contact type (N/O, N/C)

Control via Process Control System (DCS)

Inputs/outputs of Unical 9000

No.	Designation	I / O	Level	Function
42	Measuring / Service	I	0	Probe moves to measure position *
43			1	Probe moves to service position
40	Auto / Manual	I	0	Automatic interval control via Unical *
41			1	Automatic intervals blocked
37	Bin 3	I		Program selection and start, manual / DCS * ** (Program 1 ... 6 - see following page)
38	Bin 2			
39	Bin 1			
34	Measuring*** (user-defined: "Alarm")	O	0	
			1	Probe in "MEASURE" position *
33	Service	O	0	
			1	Probe in "SERVICE" position *
32	Program runs	O	0	
			1	Program running *

*) Passive contacts,
24 V must be supplied externally or via DCS

**) Signal duration at least 2 sec (passing contacts)

***) As delivered, the signal output DCS 34 serves for probe position feedback – as shown. However, you can also program this output as "Alarm". Then it sends a signal to the DCS in the event of calibration errors or faulty probe movement.

Control Programs and Measurement Procedures

Factory Settings

Control Programs of Unical 9000

6 programs and one service program can be called. 5 program flows are preset. 2 further programs can be entered by the user (User 1, User 2).

The programs are called ...



- for manual control via Protos 3400
- remotely via DCS or switch with passive inputs Bin 1 ... 3
(24 V must be externally supplied, see specifications)

Program	Description	Bin 3	Bin 2	Bin 1
1	Cleaning	0	0	1
2	Two-point calibration (Cal 2point)	0	1	0
3	One-point calibration (Cal 1point)	0	1	1
4	Park position	1	0	0
5	User-programmable (User 1)	1	0	1
6	User-programmable (User 2)	1	1	0
7	Service program	Request via M/S		

The service program (7) stops all other running programs (1 - 6) immediately and erases stored requests. For programs 1-6 the following applies:
When you start a new program, the remaining steps of a currently running program are executed first. Further requests are stored and executed subsequently. When you control the Unical 9000 via Protos 3400, you can block the Bin 1, Bin 2, Bin 3 signal lines as well as M/S and A/M to prevent conflicts (Parameter setting / Unical 9000 / Installation / Ext. control (DCS) : Off)

Measurement Procedures

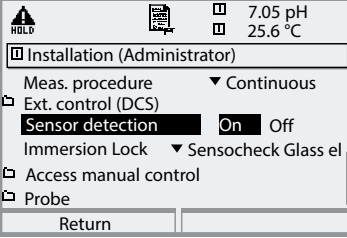
- Continuous measurement: After cleaning / calibration the probe moves into the process for measurement
- Short-time measurement (interval, sampling, sample mode ...):
After cleaning / calibration the probe remains in the calibration chamber and only moves into the process for measurement upon request.

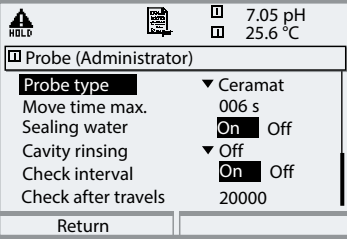
Menu	Display	<ul style="list-style-type: none"> • Sensor detection • Probe
		<p>Sensor detection</p> <p>Sensor detection “On” prevents accidental probe movement when the sensor has been removed. This is done by checking whether the temperature detector integrated in the sensor is connected or whether communication takes place (digital sensors).</p> <p>Immersion lock</p> <p>Sensocheck glass el: Prevents immersion of the probe when the sensor is broken.</p>
		<p>Probe</p> <p>Selecting the retractable fitting. Here, the max. move time is automatically adjusted (depending on model).</p> <p>Sealing water</p> <p>Sealing water is switched on shortly before the probe movement is started to keep the rinsing chamber free from medium. This is important for processes containing fibrous or adhering media.</p> <p>The sealing water pressure must be higher than the medium pressure. Intrusion of medium is prevented by the counter-pressure in the rinsing chamber which is caused by the sealing water.</p> <p>Check interval, Maintenance interval</p> <p>Permits specifying the max. admissible number of move cycles until a message is generated.</p>

Configuring Media Monitoring

Parameter setting / Probe control / Unical 9000 / Installation

Media Monitoring

For perfect system control, the pH value (or temperature) of the media used (buffer solutions, cleaning solution, rinsing water ...) can be checked against a specified value in the calibration chamber. This ensures that only correct media are used in the calibration chamber of the probe. Exchanged or contaminated media or media with a wrong temperature are recognized. In that case a message will be released. If faulty media are recognized before a calibration step, that step will not be performed.

NOTICE!

When monitoring the pH value of a medium, the zero and slope deviations of the electrode must be taken into account. Therefore the value specified for "adm. deviation" must not be too low!

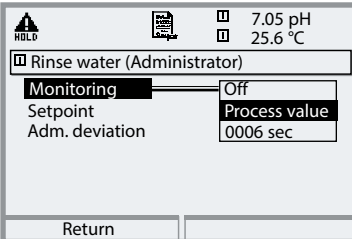
Menu	Display	Configuring media monitoring
		<p>Media monitoring can be configured in the "Parameter setting / Probe control / Installation" menu for:</p> <ul style="list-style-type: none">• Rinse water:• Media at media adapter (... in the "Media adapter" menu)• Additional media: The process value or temperature of the media can be monitored. Please note that the value specified for "Adm. deviation" should not be too low. The minimum response time is automatically taken into account when configuring the user programs.

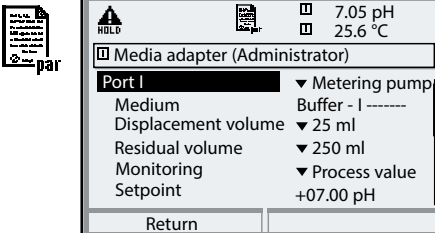
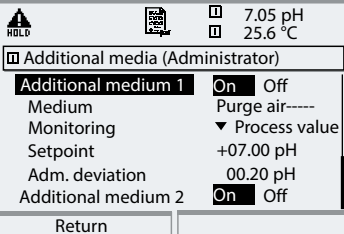
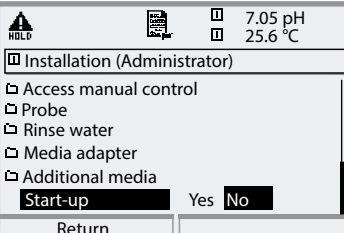
Menu	Display	<ul style="list-style-type: none"> • Media adapter, Additional media • Start-up
	<ul style="list-style-type: none"> • Media Adapter <ul style="list-style-type: none"> • Specify equipment (metering pump, Off, cleaning agent) • Designation of medium • Specify displaced volume (depending on model, e.g.: Ceramit 25 ml SensoGate 50 ml InTrac 77Xe 50 ml InTrac 797e 75 ml InTrac 798e 100 ml) • Residual volume • Monitoring (Process value/Temp) • Setpoint 	
		<ul style="list-style-type: none"> • Additional Media (2) <ul style="list-style-type: none"> • Specifying the equipment (On, Off) • Designation of medium • Monitoring (Process value/Temp) • Setpoint
		<ul style="list-style-type: none"> • Start-Up At the end of the parameter-setting procedure, a "Start-up" line appears in the "Installation" menu. When you are sure to have set all parameters, select "Yes" to confirm. Now the pumps perform the number of stroke movements required for filling the media tubes completely. The necessary rinsing cycles are automatically started.

System Forecast (Cerammat, SensoGate)

Monitoring the probe travel behavior of retractable fittings
(with Unical 9000(X) software version 4.3 or higher)

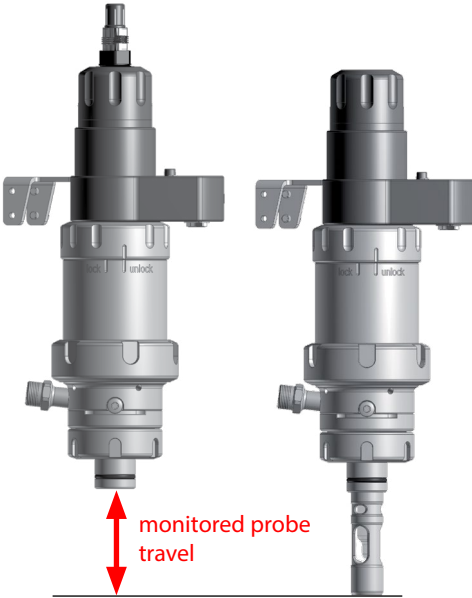

SensoGate in Service
position...

... and in
Process position

The "System Forecast" function enables monitoring of the probe travel behavior of the Ceramat or SensoGate retractable fittings. Possible signs of wear are detected in good time to prevent failure or downtimes ("predictive maintenance").

Fittings frequently display signs of wear as a change in their travel behavior. The travel time can increase significantly, for example, if aggressive media or critical processes cause the retractable fitting to become sticky or seals to swell. The switching behavior of control elements such as piezo valves also changes in the course of time, particularly with long dwell times in one position.

The opening and closing times as well as the passing capacity of these valves can then be significantly changed. Over time, pneumatically-controlled valves are also subject to changed switching times as a result of increasing friction, fatty deposits or other influences. The "System Forecast" determines whether the probe movement is continuous or jerky, which, for example, would indicate resinified fat. These changes can be recorded in a probe travel profile.

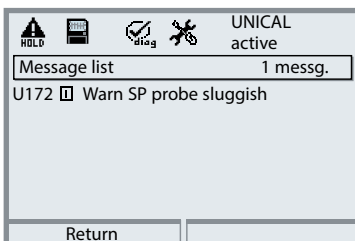

By comparing with reference times, an expert can draw conclusions on the status of the separate components, and the system itself can generate appropriate messages, see example (menu "Diagnostics / Message list").

System Forecast: Probe Travel Profiles

Reference / Probe Travel Profiles

Following installation of a system or after a repair, several cycles are run by calling the "System forecast / Edit reference profile" function. The travel behavior (probe travel profile) detected is saved as a "reference profile" with time and date. A distinction is made here between retraction behavior S (service) and insertion behavior P (process).

Creation of a Probe Travel Profile and Presentation in Protos

Menu: Parameter setting / Probe control / Installation / System forecast

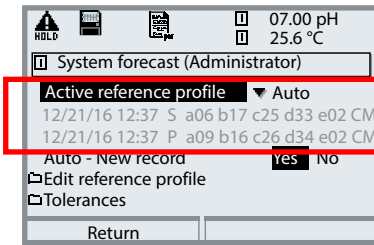

The active reference profile contains the following parameters:

12/21/16 12:37 S a06 b17 c25 d33 e02 CM

CM/SG probe type
CM: Ceramat, SG: SensoGate

aXX ... eXX Records of separate travel times

aXX: Time [1/10 s] from run command to response of air sensor.

bXX: Time [1/10 s] from run command until drop-out of the exit limit position.

cXX: Time [1/10 s] from run command to response of desired limit position.

dXX: Time [1/10 s] from run command to drop-out of air sensor.

eXX: Counter: number of air current interruptions during a travel cycle.

S/P: Direction of travel

S: Service position

P: Process position

Date and time of profile creation

Setting the System Forecast Parameters

Menu: Parameter setting / Probe control / Installation / System forecast

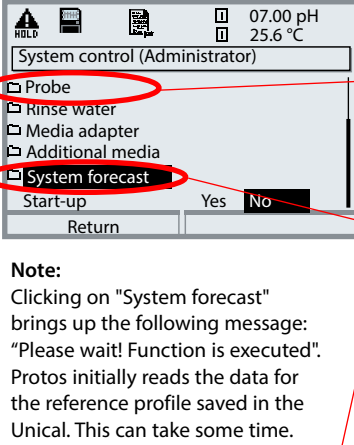
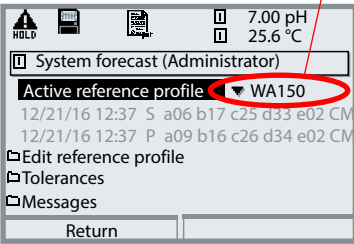
Menu	Display	System forecast
	 <p>Note: Clicking on "System forecast" brings up the following message: "Please wait! Function is executed". Protos initially reads the data for the reference profile saved in the Unical. This can take some time.</p> 	<p>Setting the system forecast parameters (only Ceramat and SensoGate types) Select a Ceramat or SensoGate retractable fitting from within the "Probe" menu item. Further parameters can then be set under "System forecast".</p> <p>Active reference profile Reference profiles are preinstalled by default for the following probes: Ceramat WA150 Ceramat WA160 SensoGate WA130S (short) SensoGate WA130L (long) These profiles can be selected under "Active reference profile".</p> <p>They are based on the following process conditions:</p> <ul style="list-style-type: none"> Process pressure: 3 bar Compressed air: 5 bar Unical hose length: 5 m Temperature: 20 °C <p>In the event of greater deviations in the process conditions, you should create an individual "User" reference profile.</p>





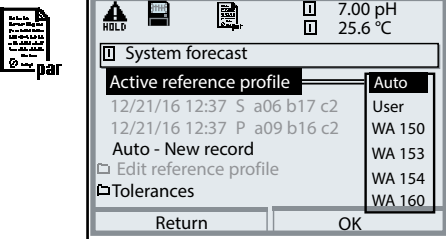

System Forecast: Reference Profile

Menu: Parameter setting / Probe control / Installation / System forecast

Menu	Display	System forecast: Active reference profile
	<p>7.00 pH 25.6 °C</p> <p>System forecast</p> <p>Active reference profile</p> <ul style="list-style-type: none"> Auto User WA 150 WA 153 WA 154 WA 160 <p>Return OK</p>	<p>Active reference profile "Auto"</p> <p>A reference profile is recorded in the background during the first probe movements (at least 20 probe movements).</p>
	<p>7.00 pH 25.6 °C</p> <p>System forecast</p> <p>Active reference profile ▼ Auto</p> <p>12/21/16 12:37 S a06 b17 c25 d33 e02 CM</p> <p>12/21/16 12:37 P a09 b16 c26 d34 e02 CM</p> <p>Auto - New record Yes No</p> <p>Edit reference profile</p> <p>Tolerances</p> <p>Return</p>	<p>Auto - New record</p> <p>The old reference profile is deleted and a new one is recorded.</p>
	<p>7.00 pH 25.6 °C</p> <p>System forecast</p> <p>01/01/00 00:00 S a00 b00 c00 d00 e00 X Auto</p> <p>01/01/00 00:00 P a00 b00 c00 d00 e00 X Auto</p> <p>12/21/16 12:37 S a06 b17 c25 d33 e02</p> <p>12/21/16 12:37 P a09 b16 c26 d34 e02</p> <p>Return S ▶▶▶</p>	<p>While recording is in progress, all values are set to "0" and the "Auto" remark is active.</p>
	<p>7.00 pH 25.6 °C</p> <p>System forecast</p> <p>12/21/16 12:37 S a06 b17 c25 d33 e02 CM Auto</p> <p>12/21/16 12:37 P a09 b16 c26 d34 e02 CM Auto</p> <p>12/21/16 12:37 S a06 b17 c25 d33 e02</p> <p>12/21/16 12:37 P a09 b16 c26 d34 e02</p> <p>12/21/16 12:37 S a06 b17 c25 d33 e02</p> <p>Return S ▶▶▶</p>	<p>"Auto" reference profile created</p> <p>After 20 probe movements the reference values are created. They are followed by the probe identifier (CM=Cerammat, SG=SensoGate) and "Auto" for the reference profile.</p>



System Forecast: Creating a Reference Profile

Menu: Parameter setting / Probe control / Installation / System forecast

Menu	Display	System forecast: Active reference profile: "User"
	<div data-bbox="180 379 535 619">    7.00 pH 25.6 °C <hr/> System forecast <hr/> Active reference profile ▼ User 12/21/16 12:37 S a06 b17 c25 d33 e02 CM 12/21/16 12:37 P a09 b16 c26 d34 e02 CM <hr/> Edit reference profile <hr/> Tolerances <hr/> Messages <hr/> Return </div> <div data-bbox="180 655 535 895">    7.00 pH 25.6 °C <hr/> Edit reference profile (Administrator) <hr/> Record new profile with "Start" softkey <hr/> 12/21/16 12:37 S a06 b17 c25 d33 e02 CM 12/21/16 12:37 P a09 b16 c26 d34 e02 CM <hr/> Reference profile ▼ User <hr/> Return Start </div>	<p data-bbox="557 373 1012 405">Creating a "User" reference profile</p> <p data-bbox="557 411 1012 651">By selecting "Edit reference profile", you can create an individual "User" reference profile. Use the Start softkey to record a reference profile. For this purpose, six probe movements are executed. The reference profile is the average of the recorded values.</p> <p data-bbox="557 708 945 772">Auto, User reference profiles: Setting tolerances</p> <p data-bbox="557 778 1012 986">For monitoring during operation, permissible deviations in the separate travel times can be set in the "Tolerances" menu. The tolerances a ... e are permissible deviations from the active reference profile.</p> <p data-bbox="557 992 754 1024">– See next page</p> <p data-bbox="557 1062 1012 1200">The name "User" cannot be modified by the user. The new profile is identifiable by the date and time of its recording.</p>

System Forecast: Tolerance Specifications

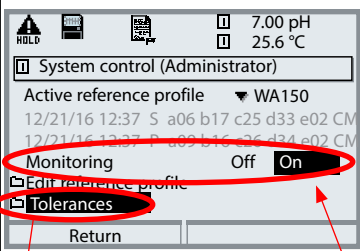
Menu: Parameter setting / Probe control / Installation / System forecast

Menu	Display	System forecast: Tolerances
		<p>Tolerance specifications</p> <p>For monitoring during operation, permissible deviations in the separate travel times can be set in the "Tolerances" menu. The tolerances "a ... e" are permissible deviations from the active reference profile.</p> <p>If monitoring is set to "on", the  icon is displayed in measuring mode if a tolerance limit is exceeded – the corresponding message text can be viewed under "Diagnostics / Messages".</p>



Tolerances (tol.)

Input range

a	Probe valve switching time (tol.+)	00 ... 99 [1/10 s]
b	Exit of limit position (tol.+)	00 ... 99 [1/10 s]
c	Achievement of limit position (tol.+)	00 ... 99 [1/10 s]
d	Air sensor deactivated (tol.+)	00 ... 99 [1/10 s]
	Air sensor deactivated (tol.-)	00 ... 99 [1/10 s]
e	Air current interruptions (tol.+)	01 ... 09 [number]
	Reference profile tolerance	00 ... 99 %



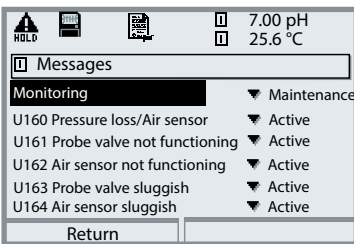











System Forecast: Reference Profiles, Messages

Menu: Parameter setting / Probe control / Installation / System forecast

Menu	Display	System forecast
	 <p>The screenshot shows a control panel interface. At the top, there are several icons: a warning triangle with 'HOLD', a document icon, a printer icon, and two status indicators showing '7.00 pH' and '25.6 °C'. Below these is a 'Messages' window with a dropdown menu set to 'Monitoring'. The list includes: <ul style="list-style-type: none"> U160 Pressure loss/Air sensor (Active) U161 Probe valve not functioning (Active) U162 Air sensor not functioning (Active) U163 Probe valve sluggish (Active) U164 Air sensor sluggish (Active) A 'Return' button is at the bottom of the list. </p>	<p>Reference profiles, messages</p> <p>Monitoring allows forecast messages to be switched off ("Off") or to be output as maintenance message ("Maintenance") or as failure message ("Failure"). The corresponding message text can be viewed under "Diagnostics / Messages".</p> <p>The individual messages can be set to "active" or "inactive" (switched off).</p> <p>With "Maintenance" selected, the  icon is shown in measuring mode when a tolerance is exceeded.</p> <p>With "Failure" selected, the  icon is shown in measuring mode when a tolerance is exceeded.</p>

System Forecast: Diagnostic Messages

Menu: Diagnostics / System forecast

Menu	Display	System forecast: Diagnostics
	<div data-bbox="180 379 534 619">     UNICAL active <p>Message list 1 messg.</p> <p>U168 SP SERVICE position not functioning</p> <p>Return</p> </div> <div data-bbox="180 651 534 890">     7.00 pH  25.6 °C <p>System forecast</p> <p>12/21/16 12:37 S a06 b17 c25 d33 e02 CM</p> <p>12/21/16 12:37 P a09 b16 c26 d34 e02 CM User</p> <p>Load probe travel profile</p> <p>Return S >>></p> </div> <div data-bbox="180 938 534 1177">     7.00 pH  25.6 °C <p>System forecast</p> <p>WA150 S a04 b11 c09 d06 e04</p> <p>WA150 P a07 b16 c10 d08 e04</p> <hr/> <p>20.07.10 07:17 S a06 b12 c11 d07 e04</p> <p>20.07.10 07:17 P a08 b17 c26 d08 e04 U188</p> <p>13.06.10 08:47 S a06 b11 c10 d07 e04</p> <p>23.06.10 08:47 P a08 b16 c26 d08 e04 U188</p> <p>Return S >>></p> </div> <p data-bbox="180 1209 534 1281">For better comparability, the travel cycles can be displayed using the right softkey:</p> <ul data-bbox="180 1289 534 1393" style="list-style-type: none"> - in Service "S" and Process "P" directions - in Service "S" direction only - in Process "P" direction only 	<p data-bbox="557 379 1033 411">Message list</p> <p data-bbox="557 419 1033 587">When you have activated "Monitoring On" in the System forecast menu, a violation of a preset tolerance will generate a message text. These texts can be viewed in the message list.</p> <p data-bbox="557 611 770 643">System forecast</p> <p data-bbox="557 651 1033 778">In operation, travel times are saved for every cycle (max. 200) and are compared with the active reference profile.</p> <p data-bbox="557 786 1033 1058">If "System forecast" is selected in the diagnostics menu, the active reference profile and probe profiles already recorded are displayed (this may take some time). If tolerance limits are exceeded in the probe travel profile, the error number is displayed after the probe profile.</p> <p data-bbox="557 1082 658 1114">NOTICE</p> <p data-bbox="557 1121 1033 1361">In the Protos/Unical system, the last 200 travel cycles are recorded in volatile memory, i.e. the data is lost when the supply voltage is switched off. Recording on a SmartMedia card is therefore recommended – see following page.</p>

System Forecast:

Recording on SmartMedia Card

Menu: Parameter setting / Probe control / Installation / System forecast

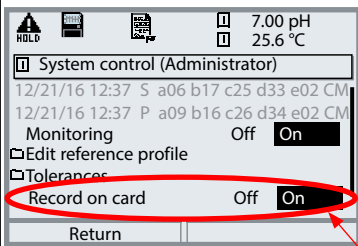
Menu	Display	System forecast: SmartMedia card
	 <p>The screenshot shows a menu interface with the following elements: a top status bar with 'HOLD', 'pH', and '7.00 pH' and '25.6 °C'; a title 'System control (Administrator)'; two lines of alphanumeric data; 'Monitoring' set to 'Off' with an 'On' button; 'Edit reference profile' and 'Tolerances' with checkboxes; 'Record on card' set to 'Off' with an 'On' button (circled in red); and a 'Return' button at the bottom. A red arrow points from the 'On' button to the text in the adjacent column.</p>	<p>Record on SmartMedia card</p> <p>If a SmartMedia card is installed, probe travel times can be saved on it (ASCII). The recording capacity is limited only by the amount of memory on the card.</p> <p>For this function, use the final menu item in the system forecast – "Record on card".</p>

System Forecast: Messages



No.	"System forecast" message	Cause
U160	SP Pressure loss/Air sensor	Air leaking uncontrolled – air sensor defective
U161	SP Probe valve not functioning	Pilot valve does not switch; probe valve possibly does not switch
U162	SP Air sensor not functioning	Air sensor does not switch
U163	SP Probe valve sluggish	Pilot valve switches late; probe valve possibly switches late
U164	SP Air sensor sluggish	Air sensor switches late
U165	SP Limit positions interrupted	Both limit positions do not switch (e.g. GND missing)
U166	SP Limit positions short-circuited	Both limit switches are actuated (short-circuited)
U170	SP Probe stopped between end positions	Probe is stuck between the limit positions
U171	SP PROCESS position sluggish	Limit switch (PROCESS) reacts too late after start of probe travel
U172	SP Probe sluggish	Probe sluggish (limit position is reached)
U173	SP Probe is stuck during probe travel	Probe is stuck during probe travel (limit position is not reached)
U174	SP SERVICE position not functioning	Limit switch (SERVICE) does not react after end of probe travel
U175	SP PROCESS position not functioning	Limit switch (PROCESS) does not react after end of probe travel
U176	SP SERVICE position sluggish	Limit switch (SERVICE) reacts too late after end of probe travel
U177	SP SERVICE position not functioning	Limit switch (SERVICE) not functioning
U178	SP PROCESS position not functioning	Limit switch (PROCESS) not functioning
U179	SP Probe instantly got stuck	Probe is stuck in limit position
U188	SP General error	Error not clearly assignable

Messages are automatically reset after two correct probe movements.

Configuring the Uniclean 900 Probe Controller

Functional Capabilities

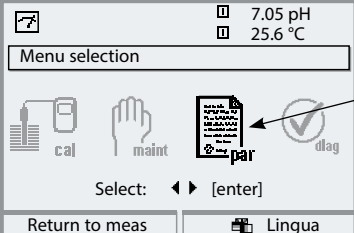
Setting	Adjustable parameters	Page
• Control	Off , Unical 9000, Uniclean 900	Pg 209
• Time control	Fixed interval , Week program: Fixed interval: Select program, interval Week program: Configuration of program flows	
• Program flow	Individual adaptation of program steps for: Rinsing, Cleaning, Parking, Service	Pg 210
• Installation Meas. procedures Ext. control (DCS)	Continuous / Short-time On, Off DCS inputs (36...39) active 10...30 V or active < 2 V M/S input (42/43) active 10...30 V or active < 2 V A/M input (40/41) active 10...30 V or active < 2 V Output DCS 34 Measuring , Alarm DCS outputs (31...34) N/O , N/C	Pg 218
• Sensor detection	On, Off	
• Access manual control	Access code required. All valves can be actuated separately.	
• Probe Move time max. Sealing water Cavity rinsing Check interval Maintenance interval	Probe type (SensoGate, Ceramat, others) Adjustable; default setting 0015 s On, Off Off , Interval, Continuous On, Off (On: Entry: Check after x travels) On, Off (On: Entry: Maintenance after x travels)	
• Media adapter (I ... III) (up to 3 pumps)	Each: Pump (On, Off), Medium, Displaced volume, Residual volume	
• Add.media (1 ... 2)	Monitoring of medium (On, Off, Medium)	
• Start-up	Yes No	Pg 223
• System forecast	On, Off	Pg 198

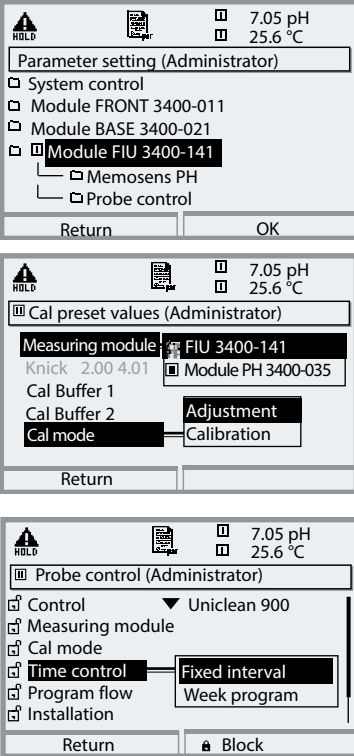
Menu	Display	Uniclean 900 parameter setting
		<p>Access Parameter Setting</p> <p>From the measuring mode: Press menu key to select menu. Select parameter setting using arrow keys, confirm by pressing enter.</p>
		<p>“Select “Probe control / Uniclean 900”. Icons to assign the measured values displayed:</p> <ul style="list-style-type: none"> <input type="checkbox"/> specifies module slot I <input type="checkbox"/> specifies module slot II <p>Measuring Module</p> <p>Select measuring module: Select the pH module for evaluation with the Uniclean 900 controller (only if equipped with more than 1 pH module).</p> <p>Time Control</p> <ul style="list-style-type: none"> • Fixed interval: Specify times (000.0 h ... xxx.x h) (Please note: 000.1 h = 6 min) • Week program: Specify weekday

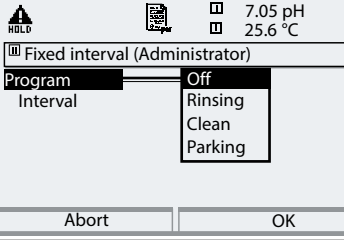
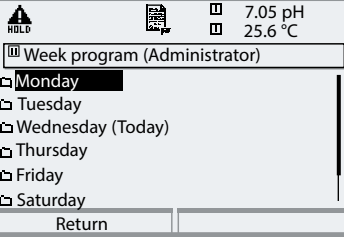
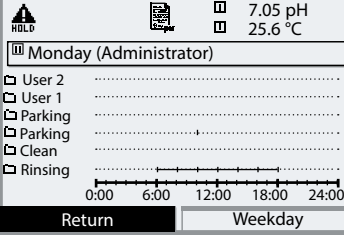
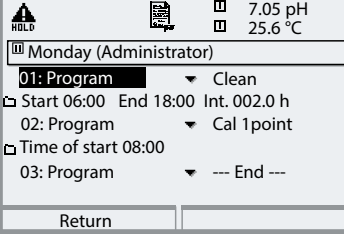
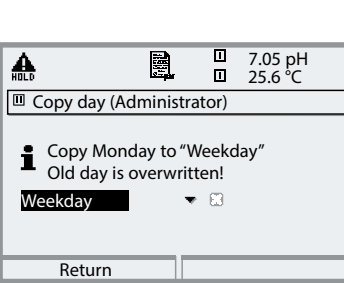
Menu	Display	Time control configuration
		<p>Time Control: Fixed Interval</p> <p>The “Fixed interval” menu allows selection of up to three programs. An individual time interval can be assigned to each program.</p>
		<p>Time Control: Week Program</p> <p>In this menu you can View, Edit and Copy.</p>
		<p>View</p> <p>shows the configured program flows over the day</p>
		<p>Edit</p> <p>allows selection of up to 10 programs per day and you can choose between “Individual start” or “Interval” (the program is executed within a start and an end time at a specified interval).</p>
		<p>Copy</p> <p>allows taking over a configured program for another weekday. (Further editing is possible.)</p>

Parameter Setting: Program Flows

Rinsing (continuous)

Display text	Time [s]
01: Probe in SERVICE	
02: Rinse water ON	0060 s
03: Rinse water Off	0002 s
04: Probe in MEASURE	0005 s
05: Program end	

Rinsing (continuous) can also be started via a DCS input signal at BIN1 input of the Uniclean 900 probe controller.

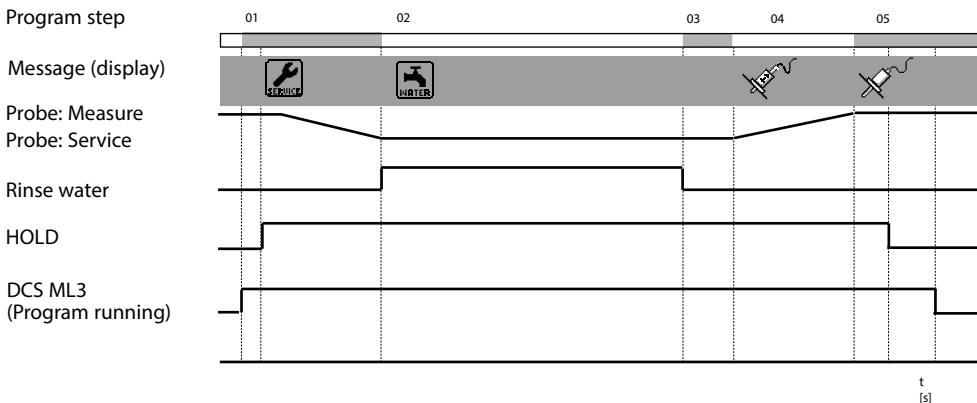

Parameter Setting: Program Flows

Cleaning (continuous)

Display text	Time [s]
01: Probe in SERVICE	
02: Cleaning agent	0020 s
03: Rinse water ON	0060 s
04: Rinse water Off	0002 s
05: Probe in MEASURE	0005 s
06: Program end	

Cleaning (continuous) can also be started via a DCS input signal at BIN1 input of the Uniclean 900 probe controller.

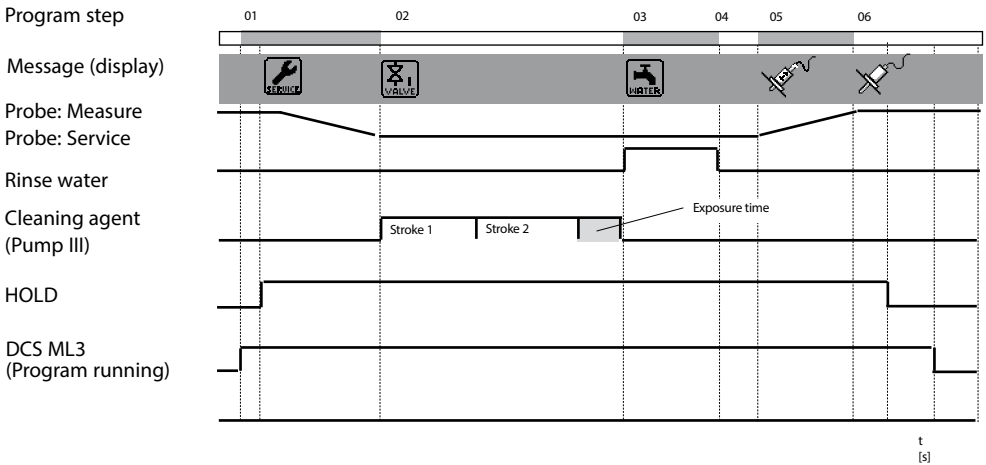

Park Program: Wait Position

The park program includes the programming step “Wait position”. When the program is started via the DCS inputs BIN 1 ... BIN 3 on the Uniclean 900, the program will be executed until the “Wait position” is reached. There it remains until the signal status at the DCS inputs changes.

- The program is started via the DCS inputs and remains in “Wait position” until the assignment of the DCS inputs changes:

DCS inputs BIN 1 ... BIN 3
of Uniclean 900



- The program is started by a short signal at the DCS inputs: Wait position is skipped.

DCS inputs BIN 1 ... BIN 3
of Uniclean 900

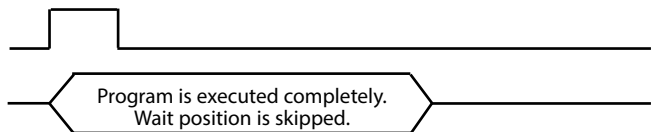

Please note:

If the programs are started by the Protos 3400(X) from the Calibration or Maintenance menu, the wait position will be skipped.

Parameter Setting: Program Flows

Parking

Display text	Time [s]
01: Probe in SERVICE	
02: Cleaning agent	0020 s
03: Rinse water ON	0060 s
04: Rinse water Off	0002 s
05: Purge air ON	0010 s
06: Purge air OFF	0002 s
07: Wait position	> Position will be held until next command (e.g. DCS)
08: Rinse water ON	0010 s
09: Rinse water Off	0002 s
10: Probe in MEASURE	0005 s
11: Program end	

Parking is started via a DCS input signal at BIN3 input of the Unclean 900 probe controller.

Program step

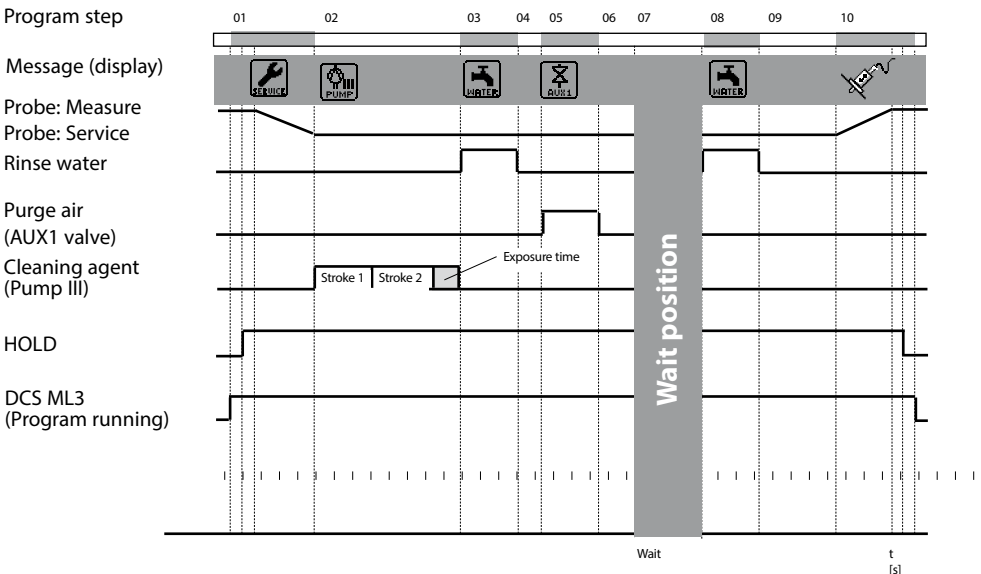

Parameter Setting: Program Flows

Measuring (short-time)

Display text	Time [s]
01: Rinse water ON	0010 s
02: Rinse water Off	0002 s
03: Probe in MEASURE	0005 s
04: Meas duration	0030 s
05: Probe in SERVICE	
06: Cleaning agent	0020 s
07: Rinse water ON	0060 s
08: Rinse water Off	0002 s
09: Program end	

Measurement (short-time) can also be started via a DCS input signal at BIN1 input of the Uniclean 900 probe controller.

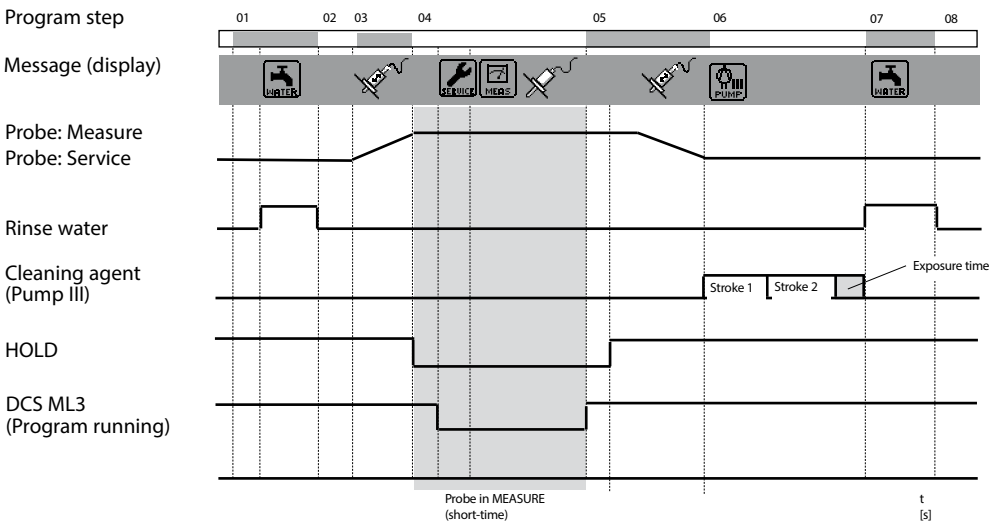

Parameter Setting: Program Flows

Service

Display text	Time [s]	
01: Probe in SERVICE		
02: Cleaning agent	0020 s	Measure -> Service
03: Rinse water ON	0060 s	
04: Rinse water Off	0002 s	
05: Purge air ON	0005 s	
06: Purge air OFF	0002 s	
07: Wait position		Service position
08: Rinse water ON	0010 s	
09: Rinse water Off	0002 s	
10: Probe in MEASURE	0005 s	Service -> Measuring
11: Program end		

Service can also be started via a DCS input signal at M/S input of the Uniclean 900 probe controller.

Program step

Message (display)

Probe: Measure

Probe: Service

Rinse water



Purge air
(AUX1 valve)

Cleaning agent
(Pump III)

HOLD

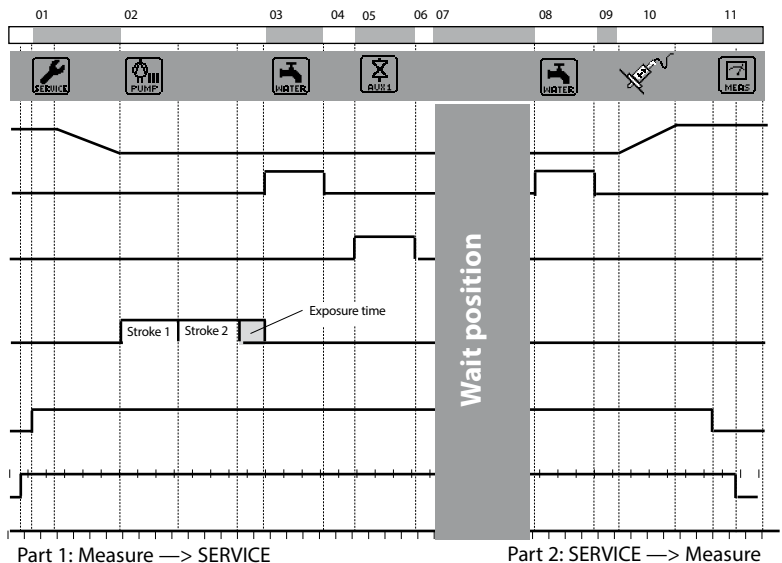
DCS ML3
(Program running)

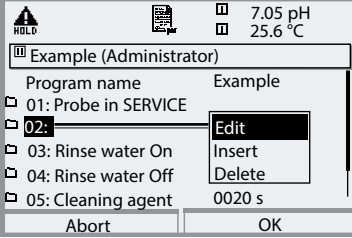

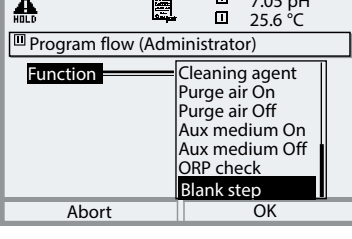





Menu	Display	Program flow Function
		<h3>Edit Program Step</h3> <p>Select the program step you want to edit using the arrow keys. Press enter: Now you can choose between "Edit, Insert, Delete".</p> <ul style="list-style-type: none"> • Edit: Allows selecting a function (see below) • Insert: Inserts an empty step above the selected program step and then allows selecting a function by "editing" the empty step. • Delete: The program step is deleted.
		<h3>Configure Function</h3> <p>Select a function using arrow keys, confirm by pressing enter.</p> <ul style="list-style-type: none"> • Functions: <ul style="list-style-type: none"> • Program end • Probe in SERVICE • Probe in MEASURE • Rinse water On • Rinse water Off • Wait time • Wait position • Cleaning agent --- Text can be edited during install. • Purge air On - Text can be edited during installation • Purge air Off - Text can be edited during installation • Aux medium On - Text can be edited during install. • Aux medium Off - Text can be edited during install. • ORP check • Blank step

Parameter Setting: Installation

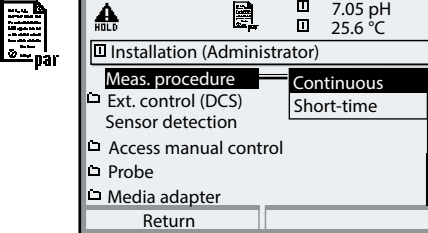
Configuration of Uniclean 900 Functions

Installation	Default setting	Adjustable parameters
• Measurement procedures	Continuous	(Continuous / Short-time)
• Ext. control (DCS)		(Polarity / Output settings)
- Signal level of inputs DCS (36 ... 39) M/S (42, 43) A/M (40, 41)	Active: 10 ... 30 V	(Active: 10 ... 30 V / active < 2V)
- Signal level of inputs DCS (31 ... 34)	N/O	(N/O / N/C)
• Sensor detection	Off	On
• Access manual control	Access code for manual control (Maintenance menu) Default: 2958	
• Probe		
- Probe type	Ceramat	(SensoGate, Other)
- Max. move time	0015 s	
- Sealing water	Off	(On)
- Cavity rinsing	Off	(Off, Interval, Continuous)
- Check interval	0000 (Off)	(max. 20,000 probe travels)
- Maintenance interval	0000 (Off)	(max. 100,000 probe travels)
• Media adapter		
- Metering pump	Off*	"On" or "Off"
- Medium	---	(e.g. "Cleaning agent A")
- Displaced volume	50 ml	(25 / 50 / 75 / 100 ml)
- Residual volume	250 ml	(0 / 250 / 500 ml)
• Additional media		
- Additional medium 1	Off	(On - then enter designation)
- Additional medium 2	Off	(On - then enter designation)
• Start-up	No	Yes/No
• System forecast	Off	Off / On: Monitors the probe travels for predictive maintenance of Ceramat und SensoGate

*Automatic adjustment by "Plug & Play" in: System control / Factory setting Uniclean

Menu	Display	<ul style="list-style-type: none"> • Meas. procedure • External control via DCS
	<p>    7.05 pH 25.6 °C </p> <p>Installation (Administrator)</p> <ul style="list-style-type: none"> Meas. procedure Continuous Ext. control (DCS) Short-time Sensor detection Access manual control Probe Media adapter <p>Return</p>	<p>Select Measurement Procedure</p> <ul style="list-style-type: none"> • Continuous measurement: With continuous measurement the pH electrode is located in the process medium and is retracted for calibration or cleaning. • Short-time measurement: (interval measurement, sampling, sample mode ...) The pH electrode is only momentarily moved into the process medium. This method is applied when measuring aggressive or thermally demanding process media which require short measurement times with long rest periods.
	<p>    7.05 pH 25.6 °C </p> <p>Ext. control (DCS) (Administrator)</p> <p>Control On Off</p> <p>DCS inputs (36...39) active 10...30V</p> <p>M/S input (42/43) active < 2 V</p> <p>A/M input (40/41) ▼ active 10...30 V</p> <p>DCS outputs (31...34) ▼ N/O</p> <p>Return</p>	<p>External Control via DCS</p> <ul style="list-style-type: none"> • DCS inputs: Inputs for selecting the control programs. Here, the active signal level is specified (< 2 V or 10 ... 30 V). • M/S input: Control of probe movement • A/M input: Intervals automatic / blocked • DCS outputs (31 ... 34): Specify contact type (N/O, N/C)

Control via Process Control System (DCS)

Inputs/Outputs of Uniclean 900

No.	Designation	I / O	Level	Function
42	Measuring / Service	I	0	Probe moves to measure position *
43			1	Probe moves to service position
40	Auto / Manual	I	0	Automatic interval control via Uniclean *
41			1	Automatic intervals blocked
37	Bin 3	I		Program selection and start, manual / DCS * **
38	Bin 2			
39	Bin 1			
34	Measuring *** (user-defined: "Alarm")	O	0	
			1	Probe in "MEASURE" position *
33	Service	O	0	
			1	Probe in "SERVICE" position *
32	Program runs	O	0	
			1	Program running *

*) Passive contacts,
24 V must be supplied externally or via DCS

**) Signal duration at least 2 sec (passing contacts)

***) As delivered, the signal output DCS 34 serves for probe position feedback – as shown. However, you can also program this output as "Alarm". Then it sends a signal to the DCS in the event of calibration errors or faulty probe movement.

Control Programs and Measurement Procedures

Factory Settings

Control Programs of Uniclean 900

3 programs and one service program can be called.

3 program flows are preset.

The programs are called ...

- for manual operation via Protos 3400(X)
- remotely via DCS or switch with passive inputs Bin 1 ... 3
(24 V must be externally supplied, see specifications)

Program	Description	Bin 3	Bin 2	Bin 1
1	Rinsing	0	0	1
2	Clean	0	1	0
3	Parking	1	0	0
4	Service program	Request via M/S		









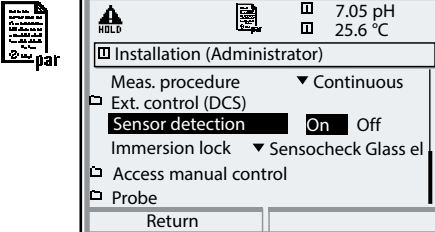
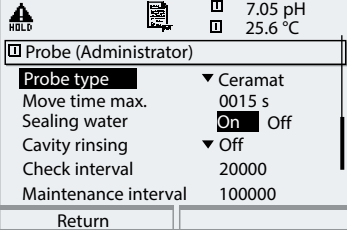

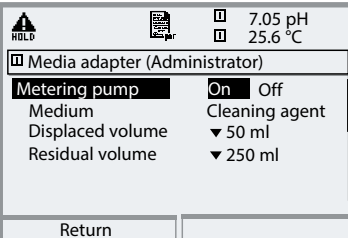

The service program (4) stops all other running programs (1 - 3) immediately and erases stored requests. For programs 1-3 the following applies:

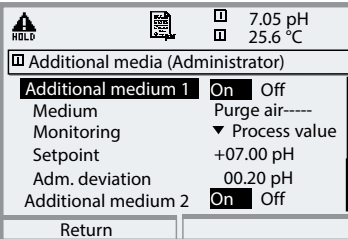
When you start a new program, the remaining steps of a currently running program are executed first. Further requests are stored and executed subsequently. When you control the Uniclean 900 via Protos 3400, you can block the Bin 1, Bin 2, Bin 3 signal lines as well as M/S and A/M to prevent conflicts (Parameter setting / Uniclean 900 / Installation / Ext. control (DCS) : Off)

Measurement Procedures

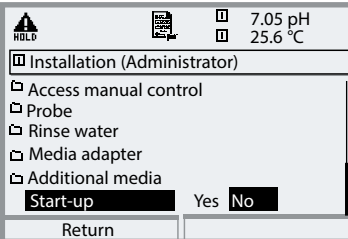
- Continuous measurement:
After cleaning / calibration the probe moves into the process for measurement
- Short-time measurement (interval, sampling, sample mode ...):
After cleaning / calibration the probe remains in the calibration chamber and only moves into the process for measurement upon request.

Menu	Display	<ul style="list-style-type: none"> • Sensor detection • Probe
		<p>Sensor Detection</p> <p>Sensor detection “On” prevents accidental probe movement when the sensor has been removed. This is done by checking whether the temperature detector integrated in the sensor is connected or whether communication takes place (digital sensors).</p> <p>Immersion Lock</p> <p>Sensocheck glass el: Prevents immersion of the probe when the sensor is broken.</p>
		<p>Probe</p> <p>Select the retractable fitting. Here, the max. move time is automatically adjusted (depending on model).</p> <p>Sealing Water</p> <p>Sealing water is switched on shortly before the probe movement is started to keep the rinsing chamber free from medium. This is important for processes containing fibrous or adhering media. The sealing water pressure must be higher than the medium pressure. Intrusion of medium is prevented by the counter-pressure in the rinsing chamber which is caused by the sealing water.</p> <p>Check Interval / Maintenance Interval</p> <p>Permits specifying the max. admissible number of move cycles until a message is generated.</p>

Menu	Display	<ul style="list-style-type: none"> • Media adapter, Additional media • Start-up
	 <p>    7.05 pH  25.6 °C </p> <p> <input type="checkbox"/> Media adapter (Administrator) </p> <p> Metering pump On Off Medium Cleaning agent Displaced volume ▼ 50 ml Residual volume ▼ 250 ml </p> <p>Return</p>	<p>Media Adapter</p> <ul style="list-style-type: none"> • Metering pump (On, Off) • Designation of medium • Specifying the displaced volume (depending on model, e.g.: Ceramat 25 ml) • Residual volume
	 <p>    7.05 pH  25.6 °C </p> <p> <input type="checkbox"/> Additional media (Administrator) </p> <p> Additional medium 1 On Off Medium Purge air---- Monitoring ▼ Process value Setpoint +07.00 pH Adm. deviation 00.20 pH Additional medium 2 On Off </p> <p>Return</p>	<p>Additional Media (2)</p> <ul style="list-style-type: none"> • Specifying the equipment (On, Off) • Designation of medium • Monitoring (Process value/Temp) • Setpoint
	 <p>    7.05 pH  25.6 °C </p> <p> <input type="checkbox"/> Installation (Administrator) </p> <p> <input type="checkbox"/> Access manual control <input type="checkbox"/> Probe <input type="checkbox"/> Rinse water <input type="checkbox"/> Media adapter <input type="checkbox"/> Additional media Start-up Yes No </p> <p>Return</p>	<p>Start-Up</p> <p>At the end of the parameter-setting procedure, a “Start-up” line appears in the “Installation” menu. When you are sure to have set all parameters, select “Yes” to confirm.</p> <p>Now the pumps perform the number of stroke movements required for filling the media tubes completely. The necessary rinsing cycles are automatically started.</p>

Maintenance of Memosens PH





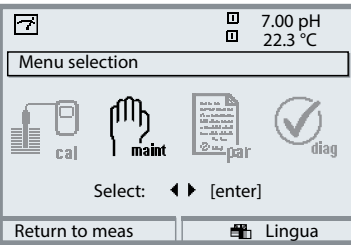
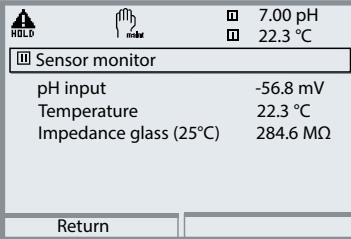
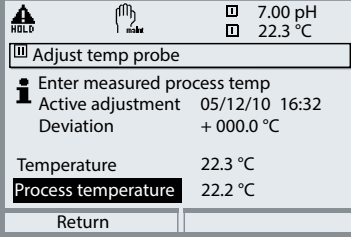

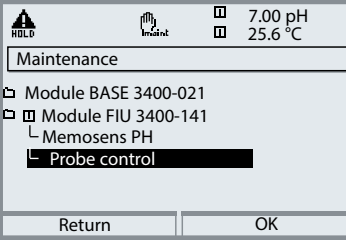

Sensor monitor, Temp probe adjustment

Note: HOLD mode is active.

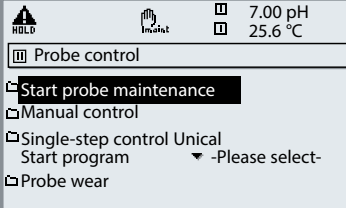
Menu	Display	Maintenance
	  	<p>Opening the maintenance menu</p> <p>From the measuring mode: Press menu key to select menu. Select maintenance using arrow keys, confirm by pressing enter. Passcode (as delivered): 2958 Then select Module FIU 3400-141 and the corresponding Memosens PH sensor.</p> <p>Sensor monitor</p> <p>For validation of sensor and complete signal processing.</p> <p>Temp probe adjustment</p> <p>This function allows compensating for the individual temperature probe tolerance and the influence of the lead resistances to increase the accuracy of temperature measurement. The adjust- ment value is stored in the sensor. Before performing an adjustment, you must precisely measure the process temperature using a calibrated refer- ence thermometer. The measurement error of the reference thermometer should be less than 0.1 °C. Adjustment without precise measurement might result in considerable deviations of the measured value display!</p>

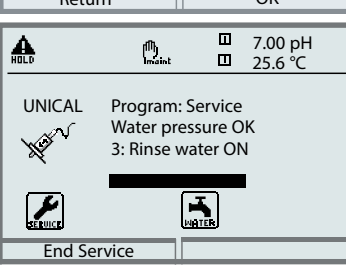
Probe Maintenance via Protos 3400

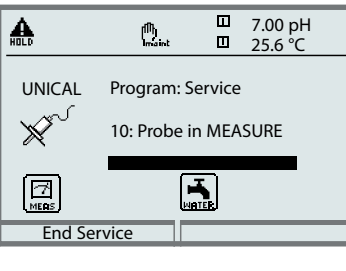
“Maintenance / Probe control” Menu

Menu	Display	Maintenance																						
	 <p>  7.00 pH  25.6 °C Maintenance Module BASE 3400-021 Module FIU 3400-141 Memosens PH Probe control </p>	<p>Select “Probe control”. Select using arrow keys, confirm by pressing enter</p>																						
	 <p>  7.00 pH  25.6 °C Probe control Start probe maintenance Manual control Single-step control Unical Start program ▼ -Please select- Probe wear </p>	<p>Probe maintenance With the Unical “SERVICE” program, the probe is moved into SERVICE position. The individual program steps are indicated in the display:</p>																						
	 <p>  7.00 pH  25.6 °C UNICAL Program: Service Water pressure OK 3: Rinse water ON [Service icon] [WATER icon] </p>	<table border="1"> <tbody> <tr><td>01: Probe in SERVICE</td><td></td></tr> <tr><td>02: Cleaning agent</td><td>0020 sec</td></tr> <tr><td>03: Rinse water ON</td><td>0060 sec</td></tr> <tr><td>04: Rinse water OFF</td><td>0002 sec</td></tr> <tr><td>05: Purge air ON</td><td>0005 sec</td></tr> <tr><td>06: Purge air OFF</td><td>0002 sec</td></tr> <tr><td>07: Wait position</td><td></td></tr> <tr><td>08: Rinse water ON</td><td>0010 sec</td></tr> <tr><td>09: Rinse water OFF</td><td>0002 sec</td></tr> <tr><td>10: Probe in MEASURE</td><td>0005 sec</td></tr> <tr><td>11: Program end</td><td></td></tr> </tbody> </table>	01: Probe in SERVICE		02: Cleaning agent	0020 sec	03: Rinse water ON	0060 sec	04: Rinse water OFF	0002 sec	05: Purge air ON	0005 sec	06: Purge air OFF	0002 sec	07: Wait position		08: Rinse water ON	0010 sec	09: Rinse water OFF	0002 sec	10: Probe in MEASURE	0005 sec	11: Program end	
	01: Probe in SERVICE																							
02: Cleaning agent	0020 sec																							
03: Rinse water ON	0060 sec																							
04: Rinse water OFF	0002 sec																							
05: Purge air ON	0005 sec																							
06: Purge air OFF	0002 sec																							
07: Wait position																								
08: Rinse water ON	0010 sec																							
09: Rinse water OFF	0002 sec																							
10: Probe in MEASURE	0005 sec																							
11: Program end																								
 <p>  7.00 pH  25.6 °C UNICAL Program: Service 10: Probe in MEASURE [MEAS icon] [WATER icon] </p>	<p>After end of servicing work the probe moves back to “Measuring” position (PROCESS).</p>																							

Manual Control via Protos 3400

“Maintenance / Probe control” Menu

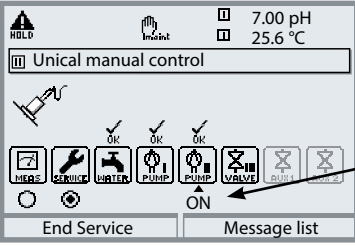
Menu	Display	Maintenance
		<p>Manual control (requires access code*) Select function using arrow keys. Symbol flashes, activate with enter – “ON” appears below the icon. End with enter. (“ON” disappears again.)</p> <p>* The access code is specified in the “Parameter setting / Installation” menu. Default: 2958.</p>



Warning for Use of Manual Control!

Make sure that the probe is separated from the process!

Manual control via Protos 3400 allows actuating the probe controller for servicing.

Rinsing water, media supply, and valve functions can be tested individually.

Single-Step Control

“Maintenance / Probe control” Menu

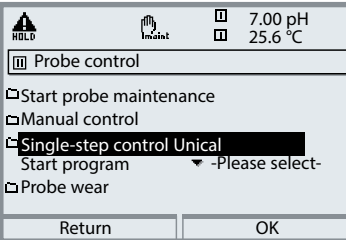
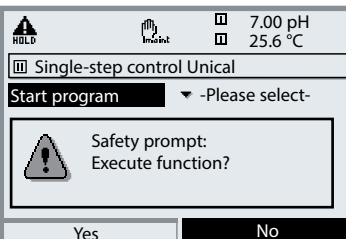
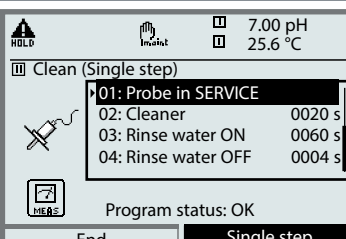
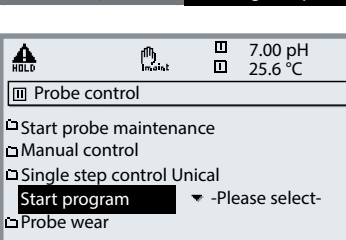
Menu	Display	Maintenance												
	   	<p>Single-step control</p> <p>Each program can be executed in single-step mode. A safety prompt is displayed before the program starts. The individual program steps are indicated in the display. A "Cleaning" program might be displayed as follows:</p> <hr/> <table border="1" data-bbox="561 695 986 903"> <tr><td>01: Probe in SERVICE</td><td></td></tr> <tr><td>02: Cleaner</td><td>0020 sec</td></tr> <tr><td>03: Rinse water ON</td><td>0060 sec</td></tr> <tr><td>04: Rinse water OFF</td><td>0002 sec</td></tr> <tr><td>05: Probe in MEASURE</td><td>0005 sec</td></tr> <tr><td>06: Program end</td><td></td></tr> </table> <hr/> <p>Start program</p> <p>Here you can select a program for test purposes:</p> <ul style="list-style-type: none"> Clean Cal 2point Cal 1point Parking User 2 User 3 	01: Probe in SERVICE		02: Cleaner	0020 sec	03: Rinse water ON	0060 sec	04: Rinse water OFF	0002 sec	05: Probe in MEASURE	0005 sec	06: Program end	
01: Probe in SERVICE														
02: Cleaner	0020 sec													
03: Rinse water ON	0060 sec													
04: Rinse water OFF	0002 sec													
05: Probe in MEASURE	0005 sec													
06: Program end														

Probe Wear

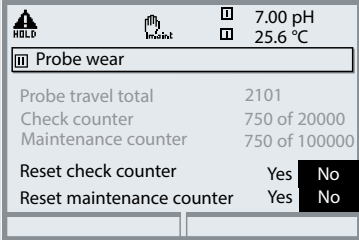

“Maintenance / Probe control” Menu

Menu	Display	Maintenance
	 <p>The screenshot shows the 'Probe wear' menu with the following data:</p> <ul style="list-style-type: none"> 7.00 pH 25,6 °C Probe travel total: 2101 Check counter: 750 of 20000 Maintenance counter: 750 of 100000 Reset check counter: Yes/No Reset maintenance counter: Yes/No 	<p>Probe wear</p> <p>There are 2 counters:</p> <ul style="list-style-type: none"> • Check counter • Maintenance counter <p>In the menu</p> <ul style="list-style-type: none"> • Parameter setting • Probe control • Installation • Probe <p>you can switch each counter on or off and set an individual interval for each counter. After expiry of this interval, a message is generated.</p> <p>You can reset the counters in the maintenance menu.</p>

Diagnostics Functions

General status information of the measuring system

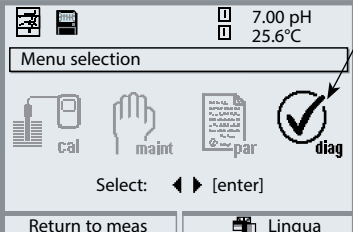
Select menu: Diagnostics - Logbook

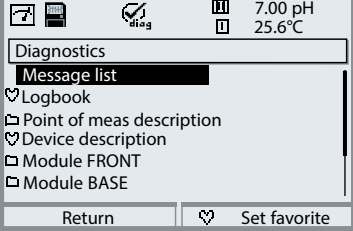
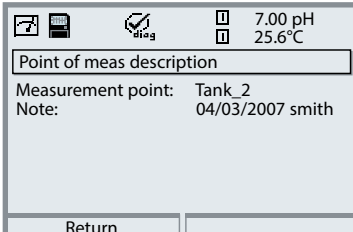
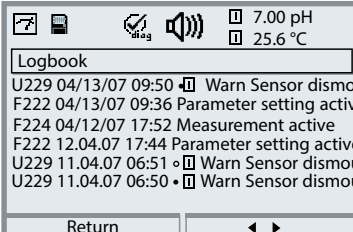
Menu	Display	Diagnostics functions
		<p>Access Diagnostics</p> <p>From the measuring mode: Press menu key to select menu. Select diagnostics using arrow keys, confirm with enter.</p>
		<p>The “Diagnostics” menu gives an overview of all functions available. Functions which have been set as “Favorite” can be directly accessed from the measuring mode.</p>
		<p>Point of Meas Description</p> <p>Allows entering a tag number and a note. Select position: left/right arrow key, select character: up/down arrow key. Confirm the entry with enter.</p>
		<p>Logbook</p> <p>The last 50 events are recorded with message identifier, date, time, and module concerned.</p> <p>This permits quality management documentation to ISO 9000 et seq.</p> <p>Extended logbook: SmartMedia card (SW 3400-104)</p>

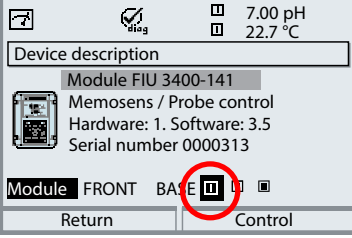
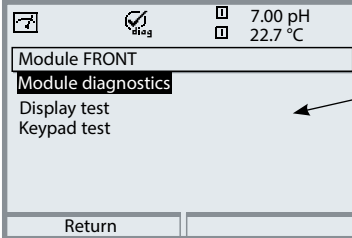
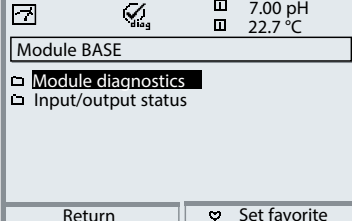
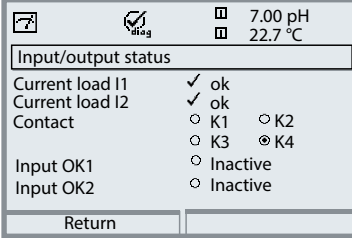
Menu	Display	Diagnostics functions
	 <p>7.00 pH 22.7 °C</p> <p>Device description</p> <p>Module FIU 3400-141</p> <p>Memosens / Probe control Hardware: 1. Software: 3.5 Serial number 0000313</p> <p>Module FRONT BASE E</p> <p>Return Control</p>	<p>Device Description</p> <p>Select module using arrow keys: Provides information about all modules installed: Function, serial number, hardware and software version, and device options.</p>
	 <p>7.00 pH 22.7 °C</p> <p>Module FRONT</p> <p>Module diagnostics</p> <p>Display test ←</p> <p>Keypad test</p> <p>Return</p>	<p>FRONT Module</p> <p>The module contains the display and keypad control. Test possibilities:</p> <ul style="list-style-type: none"> • Module diagnostics • Display test • Keypad test
	 <p>7.00 pH 22.7 °C</p> <p>Module BASE</p> <p>Module diagnostics</p> <p>Input/output status</p> <p>Return Set favorite</p>	<p>BASE Module</p> <p>The module generates the standard output signals. Test possibilities:</p> <ul style="list-style-type: none"> • Module diagnostics • Input/output status
	 <p>7.00 pH 22.7 °C</p> <p>Input/output status</p> <p>Current load I1 ✓ ok</p> <p>Current load I2 ✓ ok</p> <p>Contact ○ K1 ○ K2</p> <p>○ K3 ⊗ K4</p> <p>Input OK1 ○ Inactive</p> <p>Input OK2 ○ Inactive</p> <p>Return</p>	<p>Example:</p> <p>Module BASE, input/output status.</p>

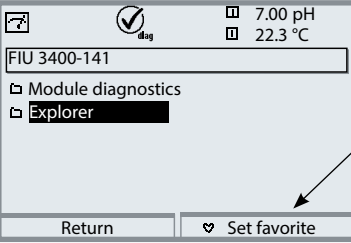
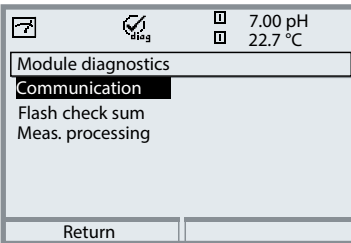
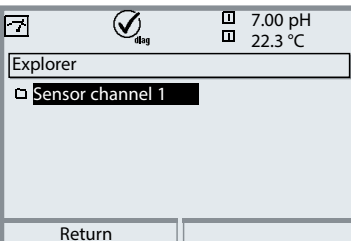

FIU 3400-141 Diagnostics

Module diagnostics / Explorer

Menu	Display	Module diagnostics, Explorer
		<p>The Diagnostics menu gives an overview of all diagnostics functions available. <u>Messages set as "Favorite"</u> can be called directly from the measuring mode using a softkey. To configure: Parameter setting / System control / Function control matrix.</p>
		<p>Module Diagnostics Self test in 3 categories.</p>
		<p>Explorer Provides information on the sensors connected to the FIU 3400-141, e.g.:</p> <ul style="list-style-type: none"> -- Memosens cable -- Serial number Hardware Software -- Memosens sensor -- Serial number Hardware Software

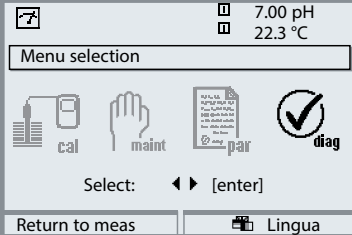

Memosens PH Diagnostics

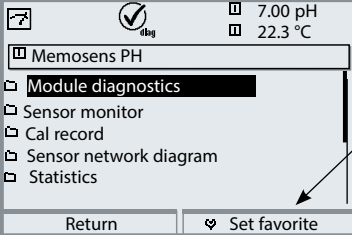
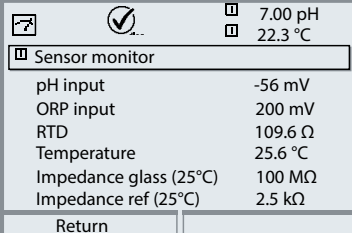
Module diagnostics / Sensor monitor

Menu	Display	Module diagnostics / Sensor monitor
		<p>Access Diagnostics</p> <p>From the measuring mode: Press menu key to select menu. Select diagnostics using arrow keys, confirm by pressing enter. Then select "Module FIU/Memosens_PH".</p>
		<p>The Diagnostics menu gives an overview of all diagnostics functions available. <u>Messages</u> set as "Favorite" can be called directly from the measuring mode using a softkey. To configure: Parameter setting / System control / Function control matrix.</p>
		<p>Module Diagnostics Internal function test.</p> <p>Sensor Monitor Shows the values currently measured by the sensor. Important function for diagnostics and validation!</p>

Memosens PH Diagnostics

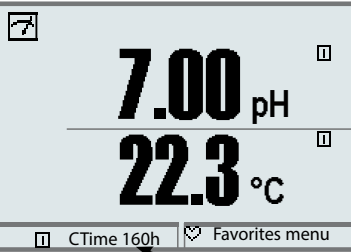
Calibration timer / Tolerance band recorder / Cal record / Sensor network diagram / Statistics

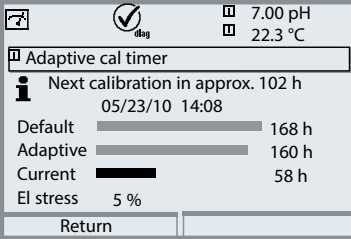
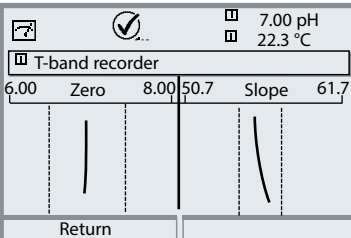



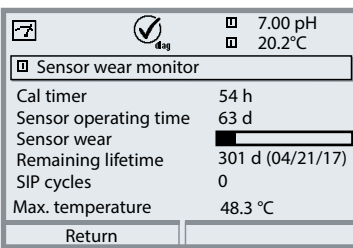

Menu	Display	Cal timer, tolerance band recorder
		<p>Calibration Timer</p> <p>After expiration of a presettable interval (Parameter setting, Module FIU, Memosens PH, Cal preset values), the calibration timer generates a warning message as a reminder that calibration is required. The remaining time can be indicated in the measuring mode by pressing a softkey (secondary display: "CTime").</p>
		<p>Adaptive Calibration Timer</p> <p>The time until the next due calibration is automatically reduced depending on the electrode stress (temperature, pH value).</p>
		<p>Tolerance Adjustment</p> <p>Additional function SW 3400-005 Records the tolerance ranges for zero and slope over the time. If the values determined by a calibration exceed the tolerance limits, an adjustment can be executed automatically. Display can be graphical or as a listing. The tolerance band (zero, slope) is configured during parameter setting (Module FIU, Memosens PH, Cal preset values).</p>

Memosens PH Diagnostics

Sensor wear monitor

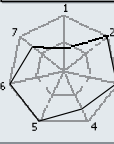
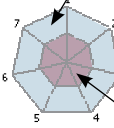

Menu	Display	Sensor wear monitor
		<p>Sensor Wear Monitor</p> <p>Based on the sensor operating time and parameters which are critical for the sensor (e.g. temperature) the sensor wear monitor calculates the "remaining lifetime" of the sensor. Next to the recommended remaining operating time (in days) you see the date when the sensor should be replaced.</p>

Memosens PH Diagnostics

Menu	Display	Cal record, Sensor network diagram, Statistics												
 diag	<div style="border: 1px solid black; padding: 5px;"> <div style="display: flex; justify-content: space-between;">   diag <input type="checkbox"/> 7.00 pH <input type="checkbox"/> 24.2°C </div> <div style="border: 1px solid black; padding: 2px; margin-top: 5px;"> <input checked="" type="checkbox"/> Cal record </div> <table style="width: 100%; border-collapse: collapse;"> <tr><td>Active adjustment</td><td>05.04.10 09:34</td></tr> <tr><td>Sensor type</td><td>SE 532 Memosens</td></tr> <tr><td>Serial number</td><td>08151234</td></tr> <tr><td>Cal mode</td><td>Data entry</td></tr> <tr><td>Zero</td><td>+07.00 pH</td></tr> <tr><td>Slope</td><td>057.7 mV/pH</td></tr> </table> <div style="display: flex; justify-content: space-between; margin-top: 5px;"> Return Calibration data </div> </div>	Active adjustment	05.04.10 09:34	Sensor type	SE 532 Memosens	Serial number	08151234	Cal mode	Data entry	Zero	+07.00 pH	Slope	057.7 mV/pH	<p>Cal Record Data of last adjustment/calibration, suitable for documentation to ISO 9000 and GLP/GMP (Date, time, calibration method, zero and slope, isothermal potential, information concerning calibration buffers and response times)</p>
Active adjustment	05.04.10 09:34													
Sensor type	SE 532 Memosens													
Serial number	08151234													
Cal mode	Data entry													
Zero	+07.00 pH													
Slope	057.7 mV/pH													
	<div style="border: 1px solid black; padding: 5px;"> <div style="display: flex; justify-content: space-between;">   diag <input type="checkbox"/> 7.00 pH <input type="checkbox"/> 24.1°C </div> <div style="border: 1px solid black; padding: 2px; margin-top: 5px;"> <input checked="" type="checkbox"/> Sensor network diagram </div> <div style="display: flex; align-items: center; margin-top: 5px;">  <div style="margin-left: 10px;"> <ul style="list-style-type: none"> 1 - Slope 2 - Zero point 3 - Ref impedance 4 - Glass impedance 5 - Response time 6 - Cal timer 7 - Sensor wear </div> </div> <div style="display: flex; justify-content: space-between; margin-top: 5px;"> Return Info </div> </div> <div style="margin-top: 20px;"> <p style="text-align: center;">"Outer circle" Value within tolerance</p>  <p style="text-align: center;">Critical range – "inner circle" Value out of tolerance Tolerance can be modified with additional function.</p> </div>	<p>Sensor Network Diagram Graphical representation of the sensor parameters. Tolerance limit violations can be seen at a glance. Critical parameters are blinking. Parameters displayed in gray have been disabled during parameter setting or do not apply to the currently selected sensor.</p> <p>The tolerance limits (radius of "inner circle") can be modified as desired.</p> <p>For more detailed information, press "Info" softkey.</p>												
	<div style="border: 1px solid black; padding: 5px;"> <div style="display: flex; justify-content: space-between;">   diag <input type="checkbox"/> 7.00 pH <input type="checkbox"/> 24.1°C </div> <div style="border: 1px solid black; padding: 2px; margin-top: 5px;"> <input checked="" type="checkbox"/> Statistics </div> <table style="width: 100%; border-collapse: collapse;"> <tr><td>Zero</td><td></td></tr> <tr><td>1st Cal</td><td>+07.00 pH 01/04/10 10:03</td></tr> <tr><td>Diff</td><td>+07.03 pH 01/04/10 10:24</td></tr> <tr><td>Diff</td><td>+07.02 pH 12/04/10 09:18</td></tr> <tr><td>Diff</td><td>+07.03 pH 28/04/10 10:47</td></tr> <tr><td>Slope</td><td></td></tr> </table> <div style="display: flex; justify-content: space-between; margin-top: 5px;"> Return </div> </div>	Zero		1st Cal	+07.00 pH 01/04/10 10:03	Diff	+07.03 pH 01/04/10 10:24	Diff	+07.02 pH 12/04/10 09:18	Diff	+07.03 pH 28/04/10 10:47	Slope		<p>Statistics Indication of sensor data for the First Calibration (adjustment) and the last 3 calibrations compared to the First Calibration. (Date and time of First Calibration, zero and slope, impedance of glass and reference electrode, response time)</p>
Zero														
1st Cal	+07.00 pH 01/04/10 10:03													
Diff	+07.03 pH 01/04/10 10:24													
Diff	+07.02 pH 12/04/10 09:18													
Diff	+07.03 pH 28/04/10 10:47													
Slope														

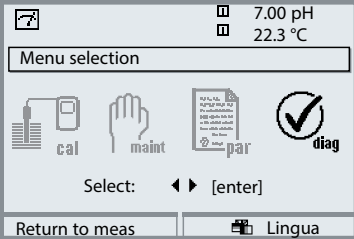

Diagnostics of Unical 9000

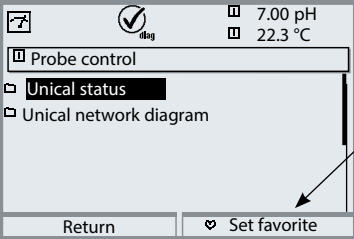
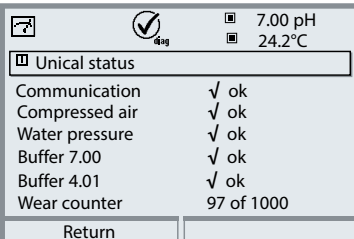
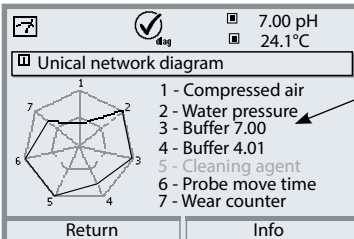
Unical status, Unical network diagram

Menu	Display	Unical status, Unical network diagram												
	 <p>7.00 pH 22.3 °C</p> <p>Menu selection</p> <p>cal maint par diag</p> <p>Select: ◀ ▶ [enter]</p> <p>Return to meas Lingua</p>	<p>Access Diagnostics</p> <p>From the measuring mode: Press menu key to select menu. Select diagnostics using arrow keys, confirm with enter. Then select Probe control.</p>												
	 <p>7.00 pH 22.3 °C</p> <p>Probe control</p> <p>Unical status</p> <p>Unical network diagram</p> <p>Return Set favorite</p>	<p>The Diagnostics menu gives an overview of all diagnostics functions available. Messages set as “Favorite” can be called directly from the measuring mode using a softkey. To configure: Parameter setting / System control / Function control matrix.</p>												
	 <p>7.00 pH 24.2 °C</p> <p>Unical status</p> <table border="0"> <tr><td>Communication</td><td>✓ ok</td></tr> <tr><td>Compressed air</td><td>✓ ok</td></tr> <tr><td>Water pressure</td><td>✓ ok</td></tr> <tr><td>Buffer 7.00</td><td>✓ ok</td></tr> <tr><td>Buffer 4.01</td><td>✓ ok</td></tr> <tr><td>Wear counter</td><td>97 of 1000</td></tr> </table> <p>Return</p>	Communication	✓ ok	Compressed air	✓ ok	Water pressure	✓ ok	Buffer 7.00	✓ ok	Buffer 4.01	✓ ok	Wear counter	97 of 1000	<p>Unical Status</p> <p>The media / ports at the media adapter are tested. The texts for the media are entered by the user during the installation (here, for example “Buffer 7.00”)</p>
Communication	✓ ok													
Compressed air	✓ ok													
Water pressure	✓ ok													
Buffer 7.00	✓ ok													
Buffer 4.01	✓ ok													
Wear counter	97 of 1000													
	 <p>7.00 pH 24.1 °C</p> <p>Unical network diagram</p> <p>1 - Compressed air 2 - Water pressure 3 - Buffer 7.00 4 - Buffer 4.01 5 - Cleaning agent 6 - Probe move time 7 - Wear counter</p> <p>Return Info</p>	<p>Unical Network Diagram</p> <p>Graphical representation of the parameters. Tolerance limit violations can be seen at a glance. For principle of function, see “Sensor network diagram”.</p>												

Diagnostics of Unclean 900

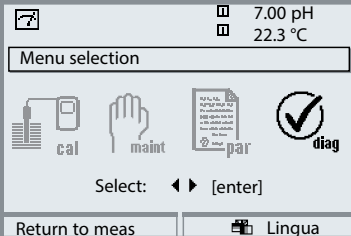
Unclean Status

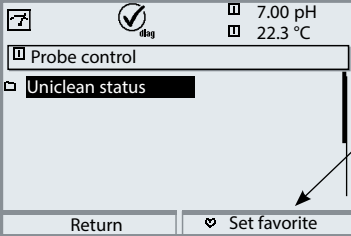
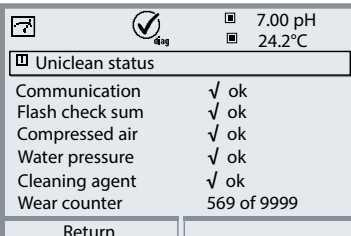
Menu	Display	Unclean status
		<p>Access Diagnostics</p> <p>From the measuring mode: Press menu key to select menu. Select diagnostics using arrow keys, confirm with enter. Then select Probe control.</p>
		<p>The Diagnostics menu gives an overview of all diagnostics functions available. Messages set as “Favorite” can be called directly from the measuring mode using a softkey. To configure: Parameter setting / System control / Function control matrix.</p>
		<p>Unclean Status</p> <p>The media / ports at the media adapter are checked. During installation, you can enter texts specifying the media (here, for example “Cleaning agent”)</p>

Setting Diagnostics Functions as Favorite

Select menu: Parameter setting/System control/Function control matrix

Secondary Displays (1)

Here, additional values are displayed in the measuring mode according to the factory setting. When the respective softkey (2) is pressed, the process variables measured by the modules plus date or time are displayed. In addition, you can use the **softkeys (2)** to control functions. To assign a function to a softkey, select

Parameter setting/System control/ Function control matrix

Function which can be controlled by softkeys:

- Parameter set selection
- KI recorder Start/Stop
- Favorites
- Unical (fully automated probe controller)

Favorites

Selected Diagnostics functions can be called directly from the measuring mode using a softkey.

The table on the next page explains how to select favorites.

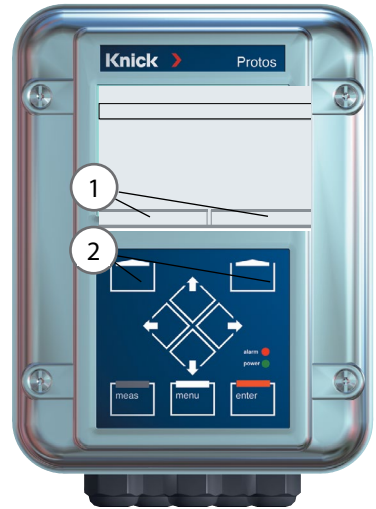

			7.00 pH	
			25.6 °C	
Function control matrix (Administrator)				
	ParSet	KI rec.	♥ Fav	Unical
Input OK2	<input type="radio"/>	<input type="radio"/>	-	-
Left softkey	<input type="radio"/>	<input type="radio"/>	-	-
Right softkey	<input type="radio"/>	<input type="radio"/>	<input checked="" type="radio"/>	-
Profibus DO 2	<input type="radio"/>	<input type="radio"/>	-	-
Return		Connect		

Example:



“Favorites” to be selected with
“Right softkey”

To select a softkey function:

Select desired function using arrow keys,
press “Connect” softkey and
confirm with **enter**.

To deselect a function:

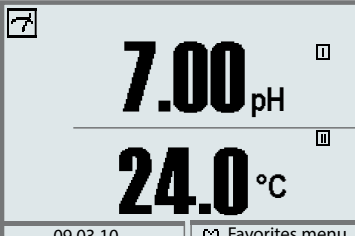
Press “Disconnect” softkey,
confirm with **enter**.

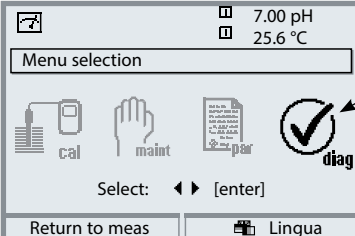
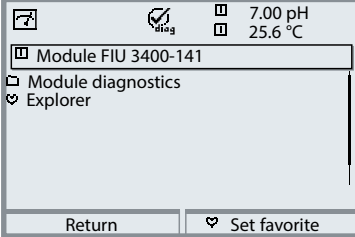
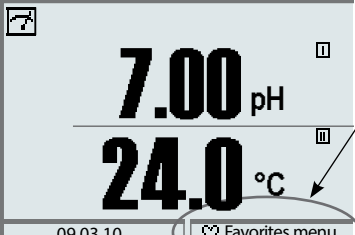
Menu	Display	Select favorites
		<p>Favorites menu</p> <p>Diagnostics functions can be called directly from the measuring mode using a softkey.</p> <p>The “Favorites” are selected in the Diagnostics menu.</p>
		<p>Select favorites</p> <p>Press menu key to select menu.</p> <p>Select diagnostics using arrow keys, confirm with enter. Then select module and confirm with enter.</p>
		<p>Set/delete favorite:</p> <p>“Set favorite” allows activation of the selected diagnostic function directly from the measuring mode via softkey. The menu line is marked with a heart icon.</p>
		<p>Pressing the meas key returns to measurement. When the softkey has been assigned to “Favorites”, “Favorites menu” is read in the secondary display (see “Function control matrix”).</p>



Note:

When one of the softkeys has been assigned to the “Favorites menu” function, diagnostic functions which have been set as “Favorite” can be directly called from the measuring mode.

Diagnostics Functions

General status information of the measuring system

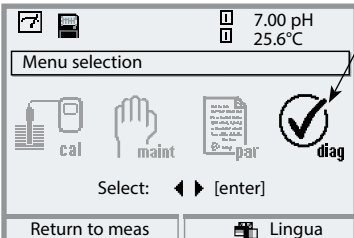
Select menu: Diagnostics - Message list

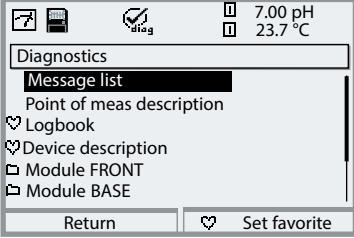
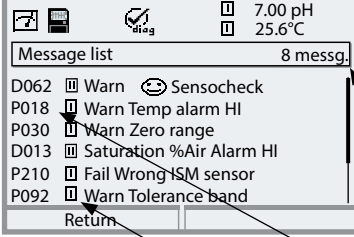
Menu	Display	Diagnostics functions
		<p>Access Diagnostics</p> <p>From the measuring mode: Press menu key to select menu. Select diagnostics using arrow keys, confirm with enter.</p>
		<p>The "Diagnostics" menu gives an overview of all functions available. Functions which have been set as "Favorite" can be directly accessed from the measuring mode.</p>
		<p>Message List</p> <p>Shows the currently activated warning or failure messages in plain text.</p> <p>Number of messages</p> <p>When there are more than 7 messages, a vertical scrollbar appears. Scroll with the up/down arrow keys.</p> <p>Message identifier</p> <p>See message list for description.</p> <p>Module identifier</p> <p>Specifies the module that has generated the message.</p>

Messages

FRONT 3400-011 Module FRONT 3400(X)-015 Module

No.	FRONT Messages	Message type
F008	Meas. processing (factory settings)	FAIL
F009	Module failure (Firmware Flash check sum)	FAIL
F060	KI process window exceeded (acknowledgeable message)	User-defined
F061	KI recorder parameter	WARN
F080	I No sensor	FAIL
F081	II No sensor	FAIL
F082	I Communication interrupted	FAIL
F083	II Communication interrupted	FAIL
F086	I Battery replacement required	WARN
F087	II Battery replacement required	WARN
F090	II No sensor	FAIL
F091	III No sensor	FAIL
F092	II Communication interrupted	FAIL
F093	III Communication interrupted	FAIL
F096	II Battery replacement required	WARN
F097	III Battery replacement required	WARN
F200	CRC error PAR	FAIL
F201	Communications error (system bus)	FAIL
F202	System failure	FAIL
F210	Device diagnostics (Self test signals error)	WARN
F211	Card error (SmartMedia)	WARN
F212	Time/date	WARN
F213	Module temperature (range exceeded)	WARN
F215	Memory card full	WARN
F216	AuditTrail card	FAIL
F220	Calibration active	Text
F221	Maintenance active	Text
F222	Parameter setting active	Text

Messages

No.	FRONT Messages	Message type
F223	Diagnostics active	Text
F225	Measurement active	Text
F226	Power supply OFF	Text
F227	Power supply ON	Text
F228	Software update	Text
F229	Wrong passcode	Text
F230	Factory setting	Text
F231	Configuration changed	Text
F232	Module equipment Ex/non-Ex	FAIL
F233	Module equipment Ex	FAIL

Messages

BASE 3400-021 Module
BASE 3400(X)-025/VPW Module
BASE 3400(X)-026/24V Module

No.	BASE Messages	Message type
B008	Meas. processing (factory settings)	FAIL
B009	Module failure (Firmware Flash check sum)	FAIL
B070	Current I1 Span	WARN
B071	Current I1 <0/4 mA	WARN
B072	Current I1 > 20 mA	WARN
B073	Current I1 Load error	FAIL
B074	Current I1 Parameter	WARN
B075	Current I2 Span	WARN
B076	Current I2 <0/4 mA	WARN
B077	Current I2 > 20 mA	WARN
B078	Current I2 Load error	FAIL
B079	Current I2 Parameter	WARN
B200	Rinsing program active	Text
B254	Module reset	Text

Messages

PH Measuring Module

No.	pH Messages	Message type
P008	Meas. processing (factory settings)	FAIL
P009	Module failure (Firmware Flash check sum)	FAIL
P010	pH range	FAIL
P011	pH Alarm LO_LO	FAIL
P012	pH Alarm LO	WARN
P013	pH Alarm HI	WARN
P014	pH Alarm HI_HI	FAIL
P015	Temperature range	FAIL
P016	Temperature Alarm LO_LO	FAIL
P017	Temperature Alarm LO	WARN
P018	Temperature Alarm HI	WARN
P019	Temperature Alarm HI_HI	FAIL
P020	ORP range	FAIL
P021	ORP Alarm LO_LO	FAIL
P022	ORP Alarm LO	WARN
P023	ORP Alarm HI	WARN
P024	ORP Alarm HI_HI	FAIL
P025	rH range	WARN
P026	rH Alarm LO_LO	FAIL
P027	rH Alarm LO	WARN
P028	rH Alarm HI	WARN
P029	rH Alarm HI_HI	FAIL
P030	Zero range	WARN
P035	Slope range	WARN
P040	Isotherm potential Uis range	WARN
P045	mV range	WARN
P046	mV Alarm LO_LO	FAIL

Messages

No.	pH Messages	Message type
P047	mV Alarm LO	WARN
P048	mV Alarm HI	WARN
P049	mV Alarm HI_HI	FAIL
P050	Man. temperature range	FAIL
P060	SAD SENSOFACE: Slope	User-defined
P061	SAD SENSOFACE: Zero	User-defined
P062	SAD SENSOFACE: Ref impedance (Sensocheck)	User-defined
P063	SAD SENSOFACE: Glass impedance (Sensocheck)	User-defined
P064	SAD SENSOFACE: Response time	User-defined
P065	SAD SENSOFACE: Calibration timer	WARN
P066	SAD SENSOFACE: Calcheck	User-defined
P069	SAD SENSOFACE: Calimatic (Zero/slope)	WARN
P070	SAD SENSOFACE: Sensor wear	User-defined
P071	SAD SENSOFACE: ISFET leakage current	User-defined
P090	Buffer offset (buffer table to be entered):	WARN
P091	Zero offset ORP	WARN
P092	Tolerance band	WARN
P110	CIP counter	User-defined
P111	SIP counter	User-defined
P112	Autoclaving counter	User-defined
P113	Sensor operating time (duration of use)	User-defined
P114	ISFET characteristic	User-defined
P115	Membrane body changes	User-defined
P120	Wrong ISM sensor	FAIL
P121	ISM sensor (error in factory settings/characteristics)	FAIL
P122	ISM sensor memory (error in cal data records)	WARN
P123	New sensor, adjustment required	WARN
P130	SIP cycle counted	Text
P131	CIP cycle counted	Text
P200	Noise level at pH input	FAIL
P201	Cal temp	WARN

Messages

No.	pH Messages	Message type
P202	Cal: Buffer unknown	Text
P203	Cal: Identical buffers	Text
P204	Cal: Buf interchanged	Text
P205	Cal: Sensor unstable	Text
P206	Cal: Slope	WARN
P207	Cal: Zero	WARN
P208	Cal: Sensor failure (ORP check)	FAIL
P254	Module reset	Text

No.	Calculation Block PH / PH Messages	Message type
A010	pH-Diff Range	FAIL
A011	pH-Diff Alarm LO_LO	FAIL
A012	pH-Diff Alarm LO	WARN
A013	pH-Diff Alarm HI	WARN
A014	pH-Diff Alarm HI_HI	FAIL
A015	Temperature-Diff Range	FAIL
A016	Temperature-Diff Alarm LO_LO	FAIL
A017	Temperature-Diff Alarm LO	WARN
A018	Temperature-Diff Alarm HI	WARN
A019	Temperature-Diff Alarm HI_HI	FAIL
A020	ORP-Diff Range	FAIL
A021	ORP-Diff Alarm LO_LO	FAIL
A022	ORP-Diff Alarm LO	WARN
A023	ORP-Diff Alarm HI	WARN
A024	ORP-Diff Alarm HI_HI	FAIL

Messages

Probe Control

No.	Probe Control Messages	Message type
U190	Probe control Buffer I almost empty	WARN
U191	Buffer II almost empty	WARN
U192	Probe control Cleaner almost empty	WARN
U194	Probe control Buffer I empty	FAIL
U195	Probe control Buffer II empty	FAIL
U196	Probe control Cleaner empty	FAIL
U219	Firmware Probe control	WARN
U220	Probe control Compressed air switch	FAIL
U221	Sensor dismantled	FAIL
U222	Undefined security status	FAIL
U224	Probe control flooded	FAIL
U225	Probe control Probe valve defective	FAIL
U226	Probe limit switch	FAIL
U227	Probe limit position SERVICE	FAIL
U228	Probe cylinder untight	WARN
U229	Sensor dismount guard defective	WARN
U230	Probe limit position MEASURE	FAIL
U231	Probe move time MEASURE	WARN
U233	Probe control Water pressure switch	WARN
U234	Probe move time SERVICE	WARN
U235	Probe control Safety valve defective	WARN
U236	Probe control No pump I	WARN
U237	Probe control No pump II	WARN
U238	Probe control No pump III	WARN
U239	Probe control No aux. valve 1	WARN
U240	Probe control No aux. valve 2	WARN
U241	Check Rinse water	WARN
U242	Check buffer I	WARN

Messages

No.	Probe Control Messages	Message type
U243	Check buffer II	WARN
U244	Check cleaner	WARN
U245	Check Add. medium 1	WARN
U246	Check Add. medium 2	WARN
U248	Probe control Water valve	WARN
U249	Proble check counter	WARN
U250	Proble maintenance counter	WARN
U251	Probe control Calibration error	WARN
U252	Probe control Communications error	WARN
U253	Probe control	WARN

System Forecast Messages

No.	"System forecast" message	Cause
U160	SP Pressure loss/Air sensor	Air leaking uncontrolled – air sensor defective
U161	SP Probe valve not functioning	Pilot valve does not switch; probe valve possibly does not switch
U162	SP Air sensor not functioning	Air sensor does not switch
U163	SP Probe valve sluggish	Pilot valve switches late; probe valve possibly switches late
U164	SP Air sensor sluggish	Air sensor switches late
U165	SP Limit positions interrupted	Both limit positions do not switch (e.g. GND missing)
U166	SP Limit positions short-circuited	Both limit switches are actuated (short-circuited)
U170	SP Probe stopped between end positions	Probe is stuck between the limit positions
U171	SP PROCESS position sluggish	Limit switch (PROCESS) reacts too late after start of probe travel
U172	SP Probe sluggish	Probe sluggish (limit position is reached)
U173	SP Probe is stuck during probe travel	Probe is stuck during probe travel (limit position is not reached)
U174	SP SERVICE position not functioning	Limit switch (SERVICE) does not react after end of probe travel
U175	SP PROCESS position not functioning	Limit switch (PROCESS) does not react after end of probe travel
U176	SP SERVICE position sluggish	Limit switch (SERVICE) reacts too late after end of probe travel
U177	SP SERVICE position not functioning	Limit switch (SERVICE) not functioning
U178	SP PROCESS position not functioning	Limit switch (PROCESS) not functioning
U179	SP Probe instantly got stuck	Probe is stuck in limit position
U188	SP General error	Error not clearly assignable

Messages are automatically reset after two correct probe movements.

Error Messages of Unical 9000(X)

NAMUR class	Protos contacts			DCS34	Message (PROTOS)
	Fct.chk	Failure	Maint req.	Alarm	
MAINT REQ.			Active		Probe move time SERVICE (U234)
MAINT REQ.			Active		Probe move time MEASURE (U231)
FAIL		Active		Active	Probe limit position SERVICE (U227)
FAIL		Active		Active	Probe limit position MEASURE (U230)
FAIL		Active		Active	Compressed air switch (U220)
FAIL		Active		Active	UNICAL Probe valve defective (U225)
FAIL		Active		Active	UNICAL flooded (U224)

Cause	System reaction	Reset	Remark
<ul style="list-style-type: none"> - Low air pressure - Probe sluggish - Filter choked - Move time too long 	None, message only	By next smooth probe movement	Limit position not reached at the first trial.
<ul style="list-style-type: none"> - Low air pressure - Probe sluggish - Filter choked - Move time too long 	None, message only	By next smooth probe movement	Limit position not reached at the first trial.
<ul style="list-style-type: none"> - Probe defective - Probe sticky - SERVICE limit switch defective - Probe valve defective * - Pilot valve defective * 	None, message only	By next smooth probe movement	SERVICE limit position was not reached even after several trials
<ul style="list-style-type: none"> - Probe defective - Probe sticky - MEASURE limit switch defective - Probe valve defective * - Pilot valve defective * 	None, message only	By next smooth probe movement	MEASURE limit position was not reached even after several trials
<ul style="list-style-type: none"> - Media adapter untight - Failure in compressed-air supply - Pressure too low - P/E converter defective - Safety valve defective (shut) 	None, message only	Automatic as soon as pressure is provided	
<ul style="list-style-type: none"> - Pilot valve or probe valve defective * 	None, message only	By next smooth probe movement	Distinction cannot be made between pilot valve and probe valve. Redundancy of pilot valves not provided any more. Can only be noticed with "SERVICE switch" function
<ul style="list-style-type: none"> - Tubings untight - Hose/tube torn off - Water valve leaking - Water stop defective 	None, message only	SERVICE request	Water has been stopped

Error Messages of Unical 9000(X)

NAMUR class	Protos contacts			DCS34	Message (PROTOS)
	Fct.chk	Failure	Maint req.	Alarm	
FAIL	Active				Sensor dismounted (U221)
FAIL		Active		Active	Undefined security status (U222)
MAINT REQ.			Active		Safety valve defective (U235)
MAINT REQ.			Active		Sensor dismount guard defective (U229)
MAINT REQ.			Active		Buffer almost empty Err text from medium description (U190/U191)
FAIL		Active		Active	Buffer empty Err text from medium description (U194/U195)
MAINT REQ.			Active		Cleaner almost empty Err text from medium description (U192)
FAIL		Active		Active	Cleaner empty Err text from medium description (U196)
MAINT REQ.			Active		UNICAL Water pressure swich (U220)

	Cause	System reaction	Reset	Remark
	<ul style="list-style-type: none"> - Sensor dismantled - Probe cylinder untight - Probe lines untight - Dismount guard defective 	Probe does not move into MEAS position, message	When sensor has been remounted	Message can only appear in SERVICE position Sensor can only be removed in SERVICE position
	<ul style="list-style-type: none"> - Voltage interruption while SERVICE switch is activated 	Red LED at service switch is lit	Switch SERVICE switch on/off Caution! Probe moves into the process	The system could not unequivocally determine whether a safe status has been achieved.
	<ul style="list-style-type: none"> - Safety valve does not close * 	None, message only		Redundancy of pilot valves not given any more. Can only be noticed with "SERVICE switch" function
	<ul style="list-style-type: none"> - Flow sensor defective - Air leak in probe cylinder - Probe lines untight 	None, message only	Replace flow sensor or eliminate other cause of defect	
	<ul style="list-style-type: none"> - Filling level below minimum - Float switch stuck - Check-back error (line interrupted or short-circuited) - Bottle untight 	None, message only	Automatic when buffer solution is topped up above min. level	Start immediately when intervals have expired
	<ul style="list-style-type: none"> - Residual bottle contents used up - Float switch stuck - Check-back error (line interrupted or short-circuited) 	All programs requiring buffer solution are blocked	Automatic when buffer solution is topped up above min. level	Start immediately when intervals have expired
	<ul style="list-style-type: none"> - Filling level below minimum - Float switch stuck - Check-back error (line interrupted or short-circuited) - Bottle untight 	None, message only	Automatic when cleaning solution is topped up above min. level	Start immediately when intervals have expired
	<ul style="list-style-type: none"> - Residual bottle contents used up - Float switch stuck - Check-back error (line interrupted or short-circuited) 	All programs requiring cleaning solution are blocked	Automatic when cleaning solution is topped up	Start immediately when intervals have expired
	<ul style="list-style-type: none"> - No water - Water pressure too low 	All programs requiring water are blocked	Automatic as soon as water pressure OK	Start immediately when intervals have expired

Error Messages of Unical 9000(X)

NAMUR class	Protos contacts			DCS34	Message (PROTOS)	
	Fct.chk	Failure	Maint req.	Alarm		
MAINT REQ.			Active		Probe cylinder untight (U228)	
MAINT REQ.			Active		Proble check counter / Proble maintenance counter (U249 / U250)	
MAINT REQ.			Active		Media monitoring Err texts from medium description (U241 ... U246)	
MAINT REQ.			Active	Active	UNICAL Calibration error (U251)	

* Can only be detected with "SERVICE switch" function.

Cause	System reaction	Reset	Remark
<ul style="list-style-type: none"> - Probe cylinder untight - Probe lines untight 	None, message only	Automatic as soon as cause of trouble removed	Probe cylinder or probe lines untight Maintenance required
<ul style="list-style-type: none"> - Counter expired 	None, message only	Manual reset in maintenance menu	
<ul style="list-style-type: none"> - Wrong medium - Wrong medium temp. - Media mixed - System untight - Probe untight 	None, message only	Automatic as soon as medium OK	
<ul style="list-style-type: none"> - Buffers interchanged - Identical buffers - Buffer unknown - Cal temp - Sensor unstable - Zero too low/high - Slope too low/high 	Calibration aborted	Automatically after next fault-free calibration	

Error Messages of Unclean 900(X)

NAMUR class	Protos contacts			DCS34	Message (PROTOS)
	Fct.chk	Failure	Maint req.	Alarm	
MAINT REQ.			Active		Probe move time SERVICE (U234)
MAINT REQ.			Active		Probe move time MEASURE (U231)
FAIL		Active		Active	Probe limit position SERVICE (U227)
FAIL		Active		Active	Probe limit position MEASURE (U230)
FAIL		Active		Active	Compressed air switch (U220)
FAIL		Active		Active	Probe valve defective (U225)
FAIL		Active		Active	UNICLEAN flooded (U224)

Cause	System reaction	Reset	Remark
<ul style="list-style-type: none"> - Low air pressure - Probe sluggish - Filter choked - Move time too long 	None, message only	By next smooth probe movement	Limit position not reached at the first trial.
<ul style="list-style-type: none"> - Low air pressure - Probe sluggish - Filter choked - Move time too long 	None, message only	By next smooth probe movement	Limit position not reached at the first trial.
<ul style="list-style-type: none"> - Probe defective - Probe sticky - SERVICE limit switch defective - Probe valve defective * - Pilot valve defective * 	None, message only	By next smooth probe movement	SERVICE limit position was not reached even after several trials
<ul style="list-style-type: none"> - Probe defective - Probe sticky - MEASURE limit switch defective - Probe valve defective * - Pilot valve defective * 	None, message only	By next smooth probe movement	MEASURE limit position was not reached even after several trials
<ul style="list-style-type: none"> - Media adapter untight - Failure in compressed-air supply - Pressure too low - P/E converter defective - Safety valve defective (shut) 	None, message only	Automatic as soon as pressure is provided	
<ul style="list-style-type: none"> - Pilot valve or probe valve defective * 	None, message only	By next smooth probe movement	Distinction cannot be made between pilot valve and probe valve. Redundancy of pilot valves not provided any more. Can only be noticed with "SERVICE switch" function
<ul style="list-style-type: none"> - Tubings untight - Hose/tube torn off - Water valve leaking - Water stop defective 	None, message only	SERVICE request	Water has been stopped

Error Messages of Uniclean 900(X)

NAMUR class	Protos contacts			DCS34	Message (PROTOS)	
	Fct.chk	Failure	Maint req.	Alarm		
FAIL	Active				Sensor dismounted (U221) (Message only with Ceramat!)	
MAINT REQ.			Active		Sensor dismount guard defective (U229) (Message only with Ceramat!)	
MAINT REQ.			Active		Cleaner almost empty (U192)	
FAIL		Active		Active	Cleaner empty (U196)	
MAINT REQ.			Active		UNICLEAN Water pressure switch (U220)	
MAINT REQ.			Active		Probe cylinder untight (U228)	
MAINT REQ.			Active		Proble check counter / Proble maintenance counter (U249 / U250)	

Cause	System reaction	Reset	Remark
<ul style="list-style-type: none"> - Sensor dismantled - Probe cylinder untight - Probe lines untight - Dismount guard defective 	Probe does not move into MEAS position, message	When sensor has been remounted	Message can only appear in SERVICE position Sensor can only be removed in SERVICE position
<ul style="list-style-type: none"> - Flow sensor defective - Air leak in probe cylinder - Probe lines untight 	None, message only	Replace flow sensor or eliminate other cause of defect	
<ul style="list-style-type: none"> - Filling level below minimum - Float switch stuck - Check-back error (line interrupted or short-circuited) - Bottle untight 	None, message only	Automatic when cleaning solution is topped up above min. level	Start immediately when intervals have expired
<ul style="list-style-type: none"> - Residual bottle contents used up - Float switch stuck - Check-back error (line interrupted or short-circuited) 	All programs requiring cleaning solution are blocked	Automatic when cleaning solution is topped up	Start immediately when intervals have expired
<ul style="list-style-type: none"> - No water - Water pressure too low 	All programs requiring water are blocked	Automatic as soon as water pressure OK	Start immediately when intervals have expired
<ul style="list-style-type: none"> - Probe cylinder untight - Probe lines untight 	None, message only	Automatic as soon as cause of trouble removed	Probe cylinder or probe lines untight Maintenance required
<ul style="list-style-type: none"> - Counter expired 	None, message only	Manual reset in maintenance menu	

Specifications

Protos FIU 3400-141-2 Specifications

Memosens I

Power supply

Interface

Transfer rate

Max. cable length

Interface for digital sensor

+3.0 ... 3.15 V / $I_{\max} = 6 \text{ mA}$, $R_i = 45 \text{ ohms}$

RS 485

9600 Bd

150m

Memosens II

Power supply

Interface

Transfer rate

Max. cable length

Interface for digital sensor

+3.0 ... 3.15 V / $I_{\max} = 6 \text{ mA}$, $R_i = 45 \text{ ohms}$

RS 485

9600 Bd

150m

Unical

Power supply

Interface

Transfer rate

Max. cable length

Interface to Unical 9000

$V_0 = 7.0 \dots 7.5 \text{ V}$, +15% / $I_{\max} = 15 \text{ mA}$, $R_i = 66 \text{ ohms}$,
for operation of Unical 9000

RS 485; +3.0 ... 3.5 V, $R_i = 45 \text{ ohms}$

1200 Bd

20m

Specifications

General Data

EMC

Emitted interference
Immunity to interference

NAMUR NE 21 and
EN 61326-1
EN 61326-2-3
Class B (residential area)
Industry

Nominal operating conditions

Ambient temperature:
-20 ... +55 °C
Rel. humidity: 10 ... 95% not condensing

Transport/Storage temperature

-20 ... +70 °C

Screw clamp connector

Single wires and flexible leads up to 2.5 mm² (AWG 14)

Appendix:

Minimum spans for current outputs – Memosens PH

Current outputs are provided by the BASE module (basic device) or by communication modules (e.g. OUT, PID). The corresponding parameters must be set there.

The minimum current span shall prevent that the resolution limit of the measurement technology (± 1 count) is seen in the current.

Memosens PH

pH	1.00
ORP	100.0
°C	10.0
mV	100.0
rH	1.00
°F	10.0

Calculation Block PH/PH

Diff pH	1.00
Diff ORP	100.0
Diff °C	10.0

Appendix:

Minimum spans for current outputs – Memosens COND

Current outputs are provided by the BASE module (basic device) or by communication modules (e.g. OUT, PID). The corresponding parameters must be set there.

The minimum current span shall prevent that the resolution limit of the measurement technology (± 1 count) is seen in the current.

Memosens COND

S/cm	20 %, min. 0.2 μ S/cm
% by wt	1.00
°C	10.0
g/kg	1.00
Ohm*cm	20 %, min. 100.0 ohms*cm
°F	10.0

Calculation Block COND/COND

Diff-S/cm	20 %, min. 0.2 μ S/cm
Diff-°C	10.0
Diff-Ohm*cm	20 %, min. 100.0 ohms*cm
RATIO	0.10
PASSAGE	10.0
REJECTION	10.0
DEVIATION	10.0
pH	1.00

Appendix:

Minimum spans for current outputs – Memosens CONDI

Current outputs are provided by the BASE module (basic device) or by communication modules (e.g. OUT, PID). The corresponding parameters must be set there.

The minimum current span shall prevent that the resolution limit of the measurement technology (± 1 count) is seen in the current.

Memosens CONDI

S/cm	20 %, min. 100.0 μ S/cm
% by wt	1.00
°C	10.0
g/kg	1.00
Ohm*cm	20 %, min. 100.0 ohms*cm
°F	10.0

Calculation Block COND/COND

Diff-S/cm	20 %, min. 100.0 μ S/cm
Diff-°C	10.0
Diff-Ohm*cm	20 %, min. 100.0 ohms*cm
RATIO	0.10
PASSAGE	10.0
REJECTION	10.0
DEVIATION	10.0

Appendix:

Minimum spans for current outputs – Memosens OXY

Current outputs are provided by the BASE module (basic device) or by communication modules (e.g. OUT, PID). The corresponding parameters must be set there.

The minimum current span shall prevent that the resolution limit of the measurement technology (± 1 count) is seen in the current.

Memosens OXY

%Air	10.0
%O ₂	2.0
°C	10.0
mbar	20.0 (air pressure)
nA	10 % min. 1.00 nA
mg/l	10 % min. 20.0 µg/l
ppm	10 % min. 20.0 ppb
mbar	20.0 (partial pressure)
Vol%	2.0
ppm	1000
°F	10.0

Calculation Block OXY/OXY

Diff-%Air	10.0
Diff-%O ₂	2.0
Diff-mg/l	10 % min. 20.0 µg/l
Diff-ppm	10 % min. 20 ppb
Diff-°C	10.0
Diff-Vol%	2.0
Diff-ppm	1000 (=0.1%vol)

Appendix:

Buffer table "Mettler-Toledo"

° C	pH			
0	2,03	4,01	7,12	9,52
5	2,02	4,01	7,09	9,45
10	2,01	4,00	7,06	9,38
15	2,00	4,00	7,04	9,32
20	2,00	4,00	7,02	9,26
25	2,00	4,01	7,00	9,21
30	1,99	4,01	6,99	9,16
35	1,99	4,02	6,98	9,11
40	1,98	4,03	6,97	9,06
45	1,98	4,04	6,97	9,03
50	1,98	4,06	6,97	8,99
55	1,98	4,08	6,98	8,96
60	1,98	4,10	6,98	8,93
65	1,99	4,13	6,99	8,90
70	1,99	4,16	7,00	8,88
75	2,00	4,19	7,02	8,85
80	2,00	4,22	7,04	8,83
85	2,00	4,26	7,06	8,81
90	2,00	4,30	7,09	8,79
95	2,00	4,35	7,12	8,77

Appendix:

Buffer table "Knick CaliMat"

°C	pH				
Order No.	CS-P0200A/...	CS-P0400A/...	CS-P0700A/...	CS-P0900A/...	CS-P1200A/...
0	2.01	4.05	7.09	9.24	12.58
5	2.01	4.04	7.07	9.16	12.39
10	2.01	4.02	7.04	9.11	12.26
15	2.00	4.01	7.02	9.05	12.13
20	2.00	4.00	7.00	9.00	12.00
25	2.00	4.01	6.99	8.95	11.87
30	2.00	4.01	6.98	8.91	11.75
35	2.00	4.01	6.96	8.88	11.64
40	2.00	4.01	6.96	8.85	11.53
50	2.00	4.01	6.96	8.79	11.31
60	2.00	4.00	6.96	8,73	11.09
70	2.00	4.00	6.96	8,70	10.88
80	2.00	4.00	6.98	8,66	10.68
90	2.00	4.00	7.00	8,64	10.48

Appendix:

Buffer table "DIN 19267"

°C	pH				
0	1,08	4,67	6,89	9,48	13,95*
5	1,08	4,67	6,87	9,43	13,63*
10	1,09	4,66	6,84	9,37	13,37
15	1,09	4,66	6,82	9,32	13,16
20	1,09	4,65	6,80	3,27	12,96
25	1,09	4,65	6,79	9,23	12,75
30	1,10	4,65	6,78	9,18	12,61
35	1,10	4,65	6,77	9,13	12,45
40	1,10	4,66	6,76	9,09	12,29
45	1,10	4,67	6,76	9,04	12,09
50	1,11	4,68	6,76	9,00	11,98
55	1,11	4,69	6,76	8,96	11,79
60	1,11	4,70	6,76	8,92	11,69
65	1,11	4,71	6,76	8,90	11,56
70	1,11	4,72	6,76	8,88	11,43
75	1,11	4,73	6,77	8,86	11,31
80	1,12	4,75	6,78	8,85	11,19
85	1,12	4,77	6,79	8,83	11,09
90	1,13	4,79	6,80	8,82	10,99
95	1,13*	4,82*	6,81*	8,81*	10,89*

* extrapoliert / extrapolated / extrapolée

Appendix:

Buffer table "NIST standard" (DIN 19266: 2000-01)

°C	pH			
0				
5	1.668	4.004	6.950	9.392
10	1.670	4.001	6.922	9.331
15	1.672	4.001	6.900	9.277
20	1.676	4.003	6.880	9.228
25	1.680	4.008	6.865	9.184
30	1,685	4.015	6.853	9.144
37	1,694	4.028	6.841	9.095
40	1.697	4.036	6.837	9.076
45	1.704	4.049	6.834	9.046
50	1.712	4.064	6.833	9.018
55	1.715	4.075	6.834	9.985
60	1.723	4.091	6.836	8.962
70	1.743	4.126	6.845	8.921
80	1.766	4.164	6.859	8.885
90	1.792	4.205	6.877	8.850
95	1.806	4.227	6.886	8.833

Notice:

The pH(S) values of the individual charges of the secondary reference materials are documented in a certificate of an accredited laboratory. This certificate is supplied with the respective buffer materials. Only these pH(S) values shall be used as standard values for the secondary reference buffer materials. Correspondingly, this standard does not include a table with standard pH values for practical use. The table above only provides examples of pH(PS) values for orientation.

Appendix:

Buffer table "Techn. buffers to NIST"

°C	pH		
0	4.00	7.14	10.30
5	4.00	7.10	10.23
10	4.00	7.04	10.11
15	4.00	7.04	10.11
20	4.00	7.02	10.05
25	4.01	7.00	10.00
30	4.01	6.99	9.96
35	4.02	6.98	9.92
40	4.03	6.98	9.88
45	4.05	6.98	9.85
50	4.06	6.98	9.82
55	4.07	6.98	9.79
60	4.09	6.99	9.76
65	4.09 *	6.99 *	9.76 *
70	4.09 *	6.99 *	9.76 *
75	4.09 *	6.99 *	9.76 *
80	4.09 *	6.99 *	9.76 *
85	4.09 *	6.99 *	9.76 *
90	4.09 *	6.99 *	9.76 *
95	4.09 *	6.99 *	9.76 *

* Values complemented

Appendix:

Buffer table "Hamilton"

°C	pH				
0	1,99	4,01	7,12	10,19	12,46
5	1,99	4,01	7,09	10,19	12,46
10	2,00	4,00	7,06	10,15	12,34
15	2,00	4,00	7,04	10,11	12,23
20	2,00	4,00	7,02	10,06	12,11
25	2,00	4,01	7,00	10,01	12,00
30	1,99	4,01	6,99	9,97	11,90
35	1,98	4,02	6,98	9,92	11,80
40	1,98	4,03	6,97	9,86	11,70
45	1,97	4,04	6,97	9,83	11,60
50	1,97	4,06	6,97	9,79	11,51
55	1,97	4,08	6,98	9,77	11,51
60	1,97	4,10	6,98	9,75	11,51
65	1,97	4,13	6,99	9,74	11,51
70	1,97	4,16	7,00	9,73	11,51
75	1,97	4,19	7,02	9,73	11,51
80	1,97	4,22	7,04	9,73	11,51
85	1,97	4,26	7,06	9,74	11,51
90	1,97	4,30	7,09	9,75	11,51
95	1,97	4,35	7,09	9,75	11,51

Appendix:

Buffer table "Kraft"

°C	pH				
0	2.01	4.05	7.13	9.24	11.47*
5	2.01	4.04	7.07	9.16	11.47
10	2.01	4.02	7.05	9.11	11.31
15	2.00	4.01	7.02	9.05	11.15
20	2.00	4.00	7.00	9.00	11.00
25	2.00	4.01	6.98	8.95	10.85
30	2.00	4.01	6.98	8.91	10.71
35	2.00	4.01	6.96	8.88	10.57
40	2.00	4.01	6.95	8.85	10.44
45	2.00	4.01	6.95	8.82	10.31
50	2.00	4.00	6.95	8.79	10.18
55	2.00	4.00	6.95	8.76	10.18*
60	2.00	4.00	6.96	8.73	10.18*
65	2.00	4.00	6.96	8.72	10.18*
70	2.01	4.00	6.96	8.70	10.18*
75	2.01	4.00	6.96	8.68	10.18*
80	2.01	4.00	6.97	8.66	10.18*
85	2.01	4.00	6.98	8.65	10.18*
90	2.01	4.00	7.00	8.64	10.18*
95	2.01	4.00	7.02	8.64	10.18*

* Values complemented

Appendix:

Buffer table "Hamilton A"

°C	pH				
0	1.99	4.01	7.12	9.31	11.42
5	1.99	4.01	7.09	9.24	11.33
10	2.00	4.00	7.06	9.17	11.25
15	2.00	4.00	7.04	9.11	11.16
20	2.00	4.00	7.02	9.05	11.07
25	2.00	4.01	7.00	9.00	11.00
30	1.99	4.01	6.99	8.95	10.93
35	1.98	4.02	6.98	8.90	10.86
40	1.98	4.03	6.97	8.85	10.80
45	1.97	4.04	6.97	8.82	10.73
50	1.97	4.05	6.97	8.78	10.67
55	1.98	4.06	6.98	8.75	10.61
60	1.98	4.08	6.98	8.72	10.55
65	1.98	4.10	6.99	8.70	10.49
70	1.99	4.12	7.00	8.67	10.43
75	1.99	4.14	7.02	8.64	10.38
80	2.00	4.16	7.04	8.62	10.33
85	2.00	4.18	7.06	8.60	10.28
90	2.00	4.21	7.09	8.58	10.23
95	2.00	4.24	7.12	8.56	10.18

Appendix:

Buffer table "Hamilton B"

°C	pH				
0	1.99	4.01	6.03	9.31	11.42
5	1.99	4.01	6.02	9.24	11.33
10	2.00	4.00	6.01	9.17	11.25
15	2.00	4.00	6.00	9.11	11.16
20	2.00	4.00	6.00	9.05	11.07
25	2.00	4.01	6.00	9.00	11.00
30	1.99	4.01	6.00	8.95	10.93
35	1.98	4.02	6.00	8.90	10.86
40	1.98	4.03	6.01	8.85	10.80
45	1.97	4.04	6.02	8.82	10.73
50	1.97	4.05	6.04	8.78	10.67
55	1.98	4.06	6.06	8.75	10.61
60	1.98	4.08	6.09	8.72	10.55
65	1.98	4.10	6.11	8.70	10.49
70	1.99	4.12	6.13	8.67	10.43
75	1.99	4.14	6.15	8.64	10.38
80	2.00	4.16	6.18	8.62	10.33
85	2.00	4.18	6.21	8.60	10.28
90	2.00	4.21	6.24	8.58	10.23
95	2.00	4.24	6.27	8.56	10.18

Appendix:

Buffer table "HACH"

T [°C]	pH		
0	4,00	7,118	10,30
5	4,00	7,087	10,23
10	4,00	7,059	10,17
15	4,00	7,036	10,11
20	4,00	7,016	10,05
25	4,01	7,000	10,00
30	4,01	6,987	9,96
35	4,02	6,977	9,92
40	4,03	6,970	9,88
45	4,05	6,965	9,85
50	4,06	6,964	9,82
55	4,07	6,965	9,79
60	4,09	6,968	9,76
65	4,10	6,980	9,71
70	4,12	7,000	9,66
75	4,14	7,020	9,63
80	4,16	7,040	9,59
85	4,18	7,060	9,56
90	4,21	7,090	9,52
95	4,24	7,120	9,48

Appendix:

Buffer table "Ciba"

°C	pH			
0	2,04	4,00	7,10	10,30
5	2,09	4,02	7,08	10,21
10	2,07	4,00	7,05	10,14
15	2,08	4,00	7,02	10,06
20	2,09	4,01	6,98	9,99
25	2,08	4,02	6,98	9,95
30	2,06	4,00	6,96	9,89
35	2,06	4,01	6,95	9,85
40	2,07	4,02	6,94	9,81
45	2,06	4,03	6,93	9,77
50	2,06	4,04	6,93	9,73
55	2,05	4,05	6,91	9,68
60	2,08	4,10	6,93	9,66
65	2,07*	4,10*	6,92*	9,61*
70	2,07	4,11	6,92	9,57
75	2,04*	4,13*	6,92*	9,54*
80	2,02	4,15	6,93	9,52
85	2,03*	4,17*	6,95*	9,47*
90	2,04	4,20	6,97	9,43
95	2,05*	4,22*	6,99*	9,38*

* Extrapolated

Appendix:

Buffer table "Reagecon"

°C	pH				
0°C	*2,01	*4,01	*7,07	*9,18	*12,54
5°C	*2,01	*4,01	*7,07	*9,18	*12,54
10°C	2,01	4,00	7,07	9,18	12,54
15°C	2,01	4,00	7,04	9,12	12,36
20°C	2,01	4,00	7,02	9,06	12,17
25°C	2,00	4,00	7,00	9,00	12,00
30°C	1,99	4,01	6,99	8,95	11,81
35°C	2,00	4,02	6,98	8,90	11,63
40°C	2,01	4,03	6,97	8,86	11,47
45°C	2,01	4,04	6,97	8,83	11,39
50°C	2,00	4,05	6,96	8,79	11,30
55°C	2,00	4,07	6,96	8,77	11,13
60°C	2,00	4,08	6,96	8,74	10,95
65°C	*2,00	*4,10	*6,99	*8,70	*10,95
70°C	*2,00	*4,12	*7,00	*8,67	*10,95
75°C	*2,00	*4,14	*7,02	*8,64	*10,95
80°C	*2,00	*4,16	*7,04	*8,62	*10,95
85°C	*2,00	*4,18	*7,06	*8,60	*10,95
90°C	*2,00	*4,21	*7,09	*8,58	*10,95
95°C	*2,00	*4,24	*7,12	*8,56	*10,95

* Values complemented

SW 3400-002: Specifiable Buffer Sets

Select menu: Parameter setting/System control/Buffer table
 Individual buffer set (with 3 buffer solutions) for pH measurement

Buffer Table

You can enter an individual buffer set (with 3 buffer solutions). To do so, you enter the nominal buffer values for the correct temperature (range 0 ... 95 °C, 5°C steps. Min. distance between buffers in the whole temperature range: 1 °C). Then this buffer set is available in addition to the permanently set standard buffer solutions in the "Calimatic buffer" menu (select "Table").

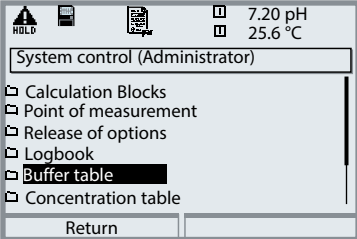
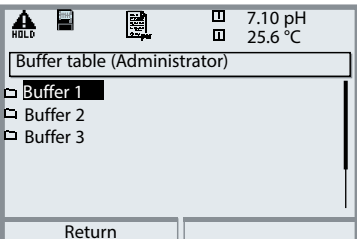
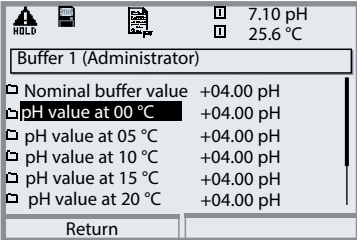
Menu	Display	Buffer table: Entering values
		<p>Enter buffer set</p> <ul style="list-style-type: none"> • Open parameter setting • System control • Select "Buffer table"
		<ul style="list-style-type: none"> • Select buffer to be entered
		<ul style="list-style-type: none"> • Enter nominal buffer value and all other values for the correct temperature (right/left arrow keys to select position, up/down arrow keys to edit number, confirm with enter.)

The special buffer set is selected as follows:

Parameter setting/Module pH/Cal preset values/Calimatic buffer/Table.

Overview of Parameter Setting

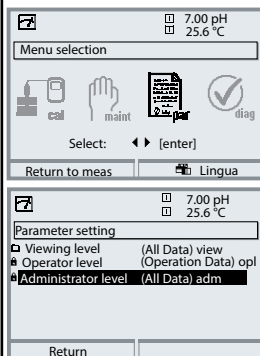

Parameter setting

Activated from measuring mode: Press **menu** key to select menu. Select parameter setting using arrow keys, confirm with **enter**.

Administrator level

Access to all functions, also passcode setting. Releasing or blocking functions for access from the Operator level.

Operator level

Access to all functions which have been released at the Administrator level. Blocked functions are displayed in gray and cannot be edited.

Viewing level

Only display, no editing possible!

System control

Memory card (Option)

- Record logbook
- Register recorder
- Decimal separator
- Card full
- Format

Menu only appears with SmartMedia Card inserted.

Make sure that it is a memory card, not an update card.

Commercially available SmartMedia cards must be formatted in the analyzer before they can be used as memory card.

Copy configuration

The complete configuration of an analyzer can be written on a SmartMedia card. This allows transferring all device settings to other devices with identical equipment (exception: options and passcodes).

Parameter sets

- Load
- Save

2 parameter sets (A,B) are available in the analyzer.

The currently active parameter set is read on the display. Parameter sets contain all settings except:

Sensor type, Options, System control settings

Up to 5 parameter sets (1, 2, 3, 4, 5) are available when a SmartMedia card (Option) is used.

Function control matrix

- Input OK2
- Left softkey
- Right softkey

Selecting the control element for the following functions:

- Parameter set selection
- KI recorder (start/stop)
- Favorites menu (selected diagnostics functions)
- Unical (fully automated probe controller)

Time/date

Selecting the display format, entry

Point of meas description

Can be called from the diagnostics menu.

Release of options

A TAN is required to release an Option.

Software update

Software update from SmartMedia card (update card)

Logbook

Selecting events to be recorded

Buffer table

Entering own buffer set for automatic calibration

Factory setting

Resetting all parameters to factory setting

Passcode entry

Editing the passcodes

Parameter Setting Menu



Display settings: FRONT module

Languages

Measurement display

- Main display
- Display format
- Viewing angle

Representation of measured values on the display:
 - Selecting the number of primary values displayed (one or two)
 - Decimal places

Measurement recorder

- Time base
- Zoom function
- Min/Max display

Option: 2-channel, selection of process variable, start and end

KI recorder

Option: See more detailed "Options" manual

Signal outputs and inputs, contacts: BASE module

Output current I1, I2

- Variable
- Curve
- Output (0/4 - 20 mA)
- Output filter
- Behavior during messages
 - HOLD
 - Current meas.
 - Last usable value
 - Fixed 22 mA
 - 22 mA message

2 current outputs, separately adjustable

Behavior during messages

Output current

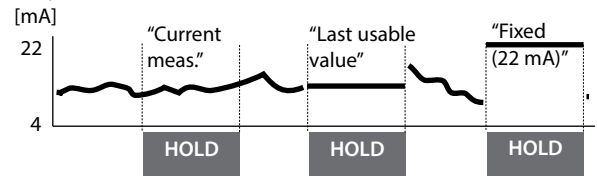

Contact K4

- Contact type
- ON delay
- OFF delay

NAMUR failure

Contacts K3, K2, K1

- Usage
 - Maintenance request
 - HOLD (function check)
 - Limit value (adjustable)
 - Rinse contact (adjustable)
 - Parameter set B active
 - USP output
 - KI recorder active
 - Sensoface
- Controller alarm (alarm output Unical/Uniclean)
- Contact type / ON/OFF delay

Factory setting:

K3: Maintenance request, K2: HOLD, K1: Limit

- Variable, limit value, hysteresis, effective direction, ...
 - Rinsing interval, lead times, rinse duration, logbook entry, ...

Inputs OK1, OK2

- OK1 usage
 - Signal level

Optocoupler - signal inputs

Off, HOLD (function check)

active level switchable from 10 to 30 V or < 2 V, resp.
 For OK2 see System control/Function control matrix

Memosens ORP Parameter Setting

Parameter	Default	Selection / Range
Input filter		
Pulse suppression	Off	On, Off
Sensor data		
Sensoface	On	On, Off
Sensor monitoring details		
Sensor parameters		SIP cycles and sensor operating time
Cal preset values		
Cal timer monitoring	Auto: 0168h	Auto, Off, Individual
ORP check	Test period 10 s Test difference 10 mV	Off, On
Delta function		
Delta function	Off	Off, ORP
Messages		
Messages ORP value	Off	Off, Variable limits

Memosens OXY Parameter Setting

Parameter	Default	Selection / Range
Input filter		
Pulse suppression	Weak	Off, Weak, Medium, Strong
Input filter	010 sec	xxx sec (entry)
Sensor data		
Measure in	Liquids	Liquids, Gases
Sensoface	On	On, Off
Sensor monitoring details		
Sensor parameters		SIP cycles and sensor operating time
Cal preset values		
Product calibration	%Air	Sat (%Air), Conc (mg/l, µg/l, ppm, ppb), p´ (mmHg, mbar)
Calibration timer		
- Monitoring	Auto	Off, Auto, Individual
- Cal timer	0000 h	Auto: 168 h (or entry: xxxx h)
Pressure correction		
Pressure transmitter	Absolute	Absolute, Difference
I input	4 ... 20 mA	0 ... 20 mA / 4 to 20 mA:
Start 0(4) mA	0000 mbar	xxxx mbars
End 20 mA.	9999 mbar	xxxx mbars
Pressure during meas	Manual	Manual (default 1013 mbars), External
Pressure during cal	Manual	Manual (default 1013 mbars), External
Salinity correction		
Entry	Salinity	Salinity, Chlorinity, Conductivity (00.00 g/kg or 0.000 µS/cm, depending on selection)
Messages Liquid (gas messages marked with *)		
Messages Saturation %Air	Off	Off, Variable limits
Messages Saturation %O ₂	Off	Off, Variable limits
Messages Concentration*	Off	Off, Variable limits
Messages Partial pressure*	Off	Off, Variable limits

Memosens COND Parameter Setting

Parameter	Default	Selection / Range
Input filter		
Pulse suppression	Off	On, Off
Sensor data		
Sensoface	On	On, Off
Sensor monitoring details		
Cell constant	Auto	Auto, Individual
Sensocheck	Off	Off, On (Message Off/Failure/Maintenance request)
CIP counter	Off	0, Max. cycles
SIP counter	Off	0, Max. cycles
Sensor operating time	Off	Entry, max. 9999 d
Cal preset values		
Cal solution	NaCl sat	NaCl 0.01 m: 1183 µS/cm NaCl 0.1 m: 10.683 mS/cm NaCl sat: 251.3 mS/cm KCl 0.01 m: 1413 µS/cm KCl 0.1 m: 12.88 mS/cm KCl 1 m: 111.80 mS/cm
Sample calibration	without TC	without TC, with TC
TC process medium		
TC correction	Off	Off, linear, EN 27888, ultrapure water Ultrapure water: Impurity NaOH, NaCl, HCl, NH ₃
Concentration		
Concentration	Off	On, Off Medium: H ₂ SO ₄ (0 ... 30 %) H ₂ SO ₄ (32 ... 84 %) H ₂ SO ₄ (92 ... 99 %) HNO ₃ (0 ... 30 %) HNO ₃ (35 ... 96 %) HCl (0 ... 18 %) HCl (22 ... 39 %) NaOH (0 ... 14 %) NaOH (18 ... 50 %) NaCl (0 ... 26 %) Table
Messages		
Messages	Temperature: Device limits max.	Conductivity, resistivity, concentration, temperature, salinity. Each variable can be monitored: Off, device limits max. or variable
USP function		

CONDI Parameter Setting

Parameter	Default	Selection / Range
Input filter		
Pulse suppression	Off	On, Off
Sensor data		
Sensoface	On	On, Off
Temperature detection	Meas. and cal temperature: Auto, TICK = Off	
Cal preset values		
Cal solution	NaCl sat	NaCl 0.01 m: 1183 μ S/cm NaCl 0.1 m: 10.683 mS/cm NaCl sat: 251.3 mS/cm KCl 0.01 m: 1413 μ S/cm KCl 0.1 m: 12.88 mS/cm KCl 1 m: 111.80 mS/cm
Product calibration	without TC	without TC, with TC
TC process medium		
TC correction	Off	Off, linear, EN 27888
Concentration		
Concentration	Off	On, Off Medium: H ₂ SO ₄ (0 ... 30 %) H ₂ SO ₄ (32 ... 84 %) H ₂ SO ₄ (92 ... 99 %) HNO ₃ (0 ... 30 %) HNO ₃ (35 ... 96 %) HCl (0 ... 18 %) HCl (22 ... 39 %) NaOH (0 ... 14 %) NaOH (18 ... 50 %) NaCl (0 ... 26 %) Table
Messages		
Messages	Temperature: Device limits max.	Conductivity, resistivity, concentration, temperature, salinity. Each variable can be monitored: Off, device limits max. or variable

PH Parameter Setting Menu



Memosens PH

Input filter

Sensoface	Representation of measured values on the display:
Sensor monitoring details	- Select
- Slope	- Select for measurement / calibration
- Zero point	
- Temperature	
- Sensocheck glass electrode	
- Response time	
- Sensor wear	
- SIP counter	
- Sensor operating time	

Cal preset values

- Calimatic buffer
- Knick CaliMat
- Mettler-Toledo
- DIN 19267
- NIST standard
- NIST technical
- Hamilton
- Kraft
- Hamilton A
- Hamilton B
- HACH
- Ciba
- Reagecon
- Table
- Drift check
- Cal timer
- Cal tolerance band

TC process medium

Select: Off, linear, ultrapure water, table

Delta function

- ### Messages
- pH value
 - Temperature
 - mV value

Unical Parameter Setting Menu



Unical 9000

Control	On / Off (automatic calibration)
Cal preset values	Selecting the calibration method for automatic control
<ul style="list-style-type: none"> • Measuring module • Cal buffer 1, Cal buffer 2 • Cal mode • Cal timer program 	<ul style="list-style-type: none"> - Select measuring module - Menu entry depending on selected sensor type Check / Adjustment Automatic program start when cal timer expired
Time control	Selecting the program (Cleaning, Cal 2point, ..., Off) and interval
<ul style="list-style-type: none"> • Fixed interval • Week program 	Select up to 10 programs per weekday, adjustable for each program are: mode (individual start / interval), start and end time. Programmed weekdays can be copied.
Program flow	Configure the detailed program sequences (Cleaning, Cal 1point calibration, Cal 2point calibration, Parking, User1 ... 2 - for free programming)
Installation	For first start-up or change of configuration
<ul style="list-style-type: none"> • Meas. procedure • External control (DCS) 	Continuous (probe always in the process) / Short-time When external controllers such as SiMatic® are used Setting the active signal level (10 ... 30 V or < 2 V)
<ul style="list-style-type: none"> - DCS inputs (36/39) - M/S input (42/43) - A/M input (40/41) - Outputs 1-3 (31-34) - DCS output 34 	Control inputs Control input Measuring / Service
<ul style="list-style-type: none"> • Sensor detection 	Select switch function (N/O or N/C) Measuring / Alarm
<ul style="list-style-type: none"> • Access manual control 	Monitoring as a dismount guard
<ul style="list-style-type: none"> • Probe type - Max. move time - Sealing water - Check/Maintenance interval • Rinse water --- Monitoring --- Setpoint --- Adm. deviation 	4-digit access code; access from maintenance menu
<ul style="list-style-type: none"> • Media adapter - Port I - Medium 1 - Displaced volume - Residual volume - Monitoring - Setpoint - Adm. deviation 	Usage: Metering pump / Off Buffer 7.00 25 / 50 / 75 / 100 ml 0 / 250 / 500 ml Process value / Temperature / Off 7.00 pH (default) 00.50 pH (default)

Unical Parameter Setting Menu



Unical 9000

• Media adapter	
- Port II	Usage: Metering pump / Off
- Medium 2	Buffer 4.01
- Displaced volume	25 / 50 / 75 / 100 ml
- Residual volume	0 / 250 / 500 ml
- Monitoring	Process value / Temperature / Off
- Setpoint	7.00 pH (default)
- Adm. deviation	00.50 pH (default)
<hr/>	
- Port III	Usage: Cleaning valve / Metering pump / Off
- Medium	Cleaning agent
- Displaced volume	25 / 50 / 75 / 100 ml
- Residual volume	0 / 250 / 500 ml
- Monitoring	Process value / Temperature / Off
- Setpoint	9.21 pH (default)
- Adm. deviation	00.50 pH (default)
<hr/>	
• Additional media	
- Additional medium 1	On / Off
- Medium	Purge air _ _ _ _ _
- Monitoring	Process value / Temperature / Off
- Setpoint	7.00 pH (default)
- Adm. deviation	00.50 pH (default)
<hr/>	
- Additional medium 2	On / Off
- Medium	Aux Medium _ _ _ _ _
- Monitoring	Process value / Temperature / Off
- Setpoint	7.00 pH (default)
- Adm. deviation	00.50 pH (default)
<hr/>	
• Start-up	Yes / No
	Makes sure that the tubings between media adapter and probe are filled with calibration medium
<hr/>	
• System forecast	Off, On:
	Monitoring of probe travel for predictive maintenance of Ceramat and SensoGate

pH Calibration Menu



Memosens PH

Calimatic
Entry of buffer values
Product calibration
Data entry

Maintenance Menu (PH and Unical)



BASE Module

Current source Output current definable 0 ... 22 mA

Memosens PH

Sensor monitor pH / ORP input, RTD, Temp, Impedance glass + ref. el.
Temp probe adjustment Compensating for lead length

Unical 9000

Start probe maintenance Service program is executed, Cal starts are possible
Manual control Access to all control elements, passcode required
 (Admin. level / Parameter setting / Unical 9000 / Installation)
Single-step control Possibility to test the program flows
Reset wear counter Reset wear counter after electrode replacement

Diagnostics Menu (PH and Unical)



Message list List of all warning and failure messages
Point of meas. description
Logbook
Device description Hardware version, Serial no., (Module) firmware, Options

FRONT Module

Module diagnostics
Display test
Keypad test

BASE Module

Module diagnostics
Input/output status

Memosens PH

Module diagnostics Internal function test
Sensor monitor Shows the values currently measured by the sensor
Cal record Data of last adjustment / calibration
Sensor network diagram PH Graphical representation of the sensor parameters
Statistics Displays first calibration and deviations of last 3 calibrations

Unical 9000

Unical status
Unical network diagram
System forecast

Index

A

Activating the cal tolerance band.....	46
Adaptive calibration timer (PH)	68
Additional function, activation	28
Additional media (Unical 9000)	197
Additional media (Uniclean 900).....	223
Adjustment (CONDI)	142
Adjustment (Memosens COND).....	118
Adjustment (Memosens OXY)	88
Adjustment (Memosens PH)	51
Administrator level	33
Appendix	262
Audit Trail Log.....	15
Automatic buffer recognition (Calimatic)	56
Automatic calibration in air.....	94
Automatic calibration in water	92
Automatic calibration with standard calibration solution (CONDI)	146
Automatic calibration with standard cal solution (COND)	122
Automatic temperature compensation (COND).....	119
Automatic temperature compensation (CONDI).....	143
Automatic temperature compensation (PH)	53

B

BASE module	21
Behavior during messages	162
Buffer sets to be entered	279
Buffer tables	267
Buffer values, manual entry for calibration	58

C

Cable glands.....	18
Cal 1point (program flow Unical 9000).....	182
Cal 1point, short-time (program flow Unical 9000).....	187
Cal 2point, continuous (program flow Unical 9000)	181
Cal 2point, short-time (program flow Unical 9000).....	186
Calculation Blocks	113
Calibrating the sensors (COND)	129
Calibrating the sensors (CONDI).....	153
Calibration by entering data from premeasured electrodes	62
Calibration by sampling (OXY).....	96
Calibration (CONDI)	141

Index

Calibration (Memosens COND)	117
Calibration (Memosens ORP)	74
Calibration (Memosens OXY)	87
Calibration (Memosens PH)	50
Calibration methods (PH)	52
Calibration, preset values (OXY)	85
Calibration timer (PH)	68
Calibration with sampling (COND)	126
Calibration with sampling (CONDI)	150
Calibration with sampling (PH)	60
Calimatic (PH)	56
Cal presettings for Unical 9000	178
Cal presettings for Uniclean 900	209
Cal record (COND)	132
Cal record (CONDI)	156
Cal record (ORP)	79
Cal record (OXY)	102
Cal record (PH)	66
Cal timer program (Unical 9000)	178
Change passcode	30
Check counter	228
Check interval (program flow Unical 9000)	195
Check interval (Uniclean 900)	222
Cleaning, continuous (program flow Unical 9000)	180
Cleaning, continuous (program flow Uniclean 900)	212
Concentration curves (COND)	106
Concentration curves (CONDI)	136
Concentration table (COND)	109
Concentration table (CONDI)	139
CONDI parameter setting	133
CONDI: range and presettings	135
COND: range and presettings	105
Configuration with ProgaLog 3000	37
Configurator menu of "ProgaLog 3000"	40
Configure function (Unical 9000)	190
Configure function (Uniclean 900)	217
Configure program flow (Unical 9000)	189
Configuring the module	41
Connection of Memosens (RS-485 cable)	26
Connection of probe controller	174

Index

Contacts.....	158
Contact type.....	168
Control programs (Unical 9000).....	194
Control programs (Uniclean 900).....	221
Control via process control system (Unical 9000).....	193
Control via process control system (Uniclean 900).....	220
Current outputs.....	158
Current outputs, characteristics.....	159

D

Data entry of premeasured electrodes.....	62
Data entry of premeasured sensors (COND).....	128
Data entry of premeasured sensors (CONDI).....	152
Data entry of premeasured sensors (OXY).....	98
Delta function (ORP).....	72
Delta function (PH).....	48
Device description.....	230
Device limits, messages (ORP).....	73
Device limits, messages (OXY).....	86
Device limits, messages (PH).....	49
Device software.....	16
Diagnostics CONDI.....	155
Diagnostics functions.....	229
Diagnostics functions as favorite.....	238
Diagnostics (Memosens COND).....	131
Diagnostics (Memosens ORP).....	77
Diagnostics (Memosens OXY).....	101
Diagnostics (Memosens PH).....	65
Diagnostics messages (system forecast).....	205
Diagnostics of FIU 3400-141.....	231
Diagnostics of Unical 9000.....	236
Diagnostics of Uniclean 900.....	237
Display icons.....	304
Disposal.....	2
Documenting parameter setting.....	35, 36

Index

E

Edit program step (Unical 9000).....	189
Edit program step (Uniclean 900).....	217
Electronic Signature.....	15
EMC.....	261
Error messages.....	241
Error messages of Unical 9000(X).....	250
Error messages of Uniclean 900(X).....	256
Error messages (system forecast).....	207
Explorer.....	231
External control via DCS (Unical 9000).....	192
External control via DCS (Uniclean 900).....	219

F

Factory setting.....	157
Failure.....	163
Favorites.....	238
FDA 21 CFR Part 11.....	15
FIU 3400-141 diagnostics.....	231
Fixed interval (Unical 9000).....	179
Fixed interval (Uniclean 900).....	210
Forecast messages.....	204
FRONT module.....	20
Function check.....	163

G

Generating messages (ORP).....	73
Generating messages (OXY).....	86
Generating messages (PH).....	49
Graphic display.....	18

H

Hardware and software version.....	16
Hydrochloric acid, concentration curves.....	107, 137
Hysteresis.....	168

Index

I

Icons	304
Immersion lock (Unical 9000)	195
Immersion lock (Uniclean 900)	222
Individual buffer set	279
Inserting the module	23
Intended use	13
Interfaces	25

L

LED	18
Limit value	168
Limit value, icons in the measurement display	168
Linear characteristic	159
Lock functions	34
Lock icon	34
Logarithmic output curve	160
Logbook (ORP)	77
Logbook, parameter setting	157
Logbook (PH)	65

M

Maintenance CONDI	154
Maintenance counter	228
Maintenance interval (Unical 9000)	195
Maintenance interval (Uniclean 900)	222
Maintenance (Memosens COND)	130
Maintenance (Memosens OXY)	100
Maintenance (Memosens PH)	64
Maintenance (ORP)	76
Maintenance request	163
Manual control (Unical)	226
Manual entry of buffer values	58
Manual entry of cal solution (COND)	124
Manual entry of cal solution (CONDI)	148
Measurement display	31
Measurement procedures (Unical 9000)	194
Measurement procedures (Uniclean 900)	221
Measuring circuit	176
Measuring circuit function block	173

Index

Measuring, short-time (program flow Unical 9000)	185
Measuring, short-time (program flow Uniclean 900)	215
Media adapter (Unical 9000).....	197
Media adapter (Uniclean 900)	223
Media at media adapter (Unical 9000).....	196
Media monitoring (Unical 9000).....	196
Memosens COND parameter setting.....	103
Memosens, connection.....	26
Memosens ORP parameter setting.....	69
Memosens OXY parameter setting.....	83
Memosens OXY (TAN required)	81
Memosens PH diagnostics.....	232
Menu selection.....	29
Menu structure.....	19
Message list	240
Message list (ORP).....	73
Message list (OXY)	86
Message list (PH)	49
Message list (system forecast)	207
Messages	240, 241
Messages (ORP).....	70
Messages (PH)	44
Messages, response of current outputs.....	162
Messages (system forecast)	204
Message when the current range is exceeded	162
Modular concept	17
Module diagnostics (FIU 3400-141).....	231
Module diagnostics (Memosens PH)	232
Module equipment.....	21
Modules	20
Module software	16
Monitoring, activation (Unical 9000)	190
Monitoring functions for calibration (PH).....	63
Monitoring the behavior of retractable fittings.....	198
N	
NAMUR signals, current outputs	162
NAMUR signals, relay contacts	163
Nitric acid, concentration curves.....	106, 136

Index

O

OK1,OK2 inputs.....	169
OK1/OK2 switching level.....	169
OK1 usage.....	169
OK2, selecting parameter set (A, B).....	170
OK inputs.....	158
Oleum, concentration curves.....	108, 138
One-point calibration (COND).....	117
One-point calibration (CONDI).....	141
One-point calibration (OXY).....	87
One-point calibration (PH).....	52
Operating levels.....	33
Operating mode.....	41
Operating mode "Memosens".....	175
Operator level.....	33
Option release SW 3400-005.....	46
Option release SW 3400-015/016.....	82
ORP calibration/adjustment.....	74
ORP: range and presetsings.....	71
ORP related to the standard hydrogen electrode.....	74
Output filter.....	161
Overview of functions.....	3
Overview of parameter setting.....	280
Overview of system components.....	171
OXY: range and presetsings.....	85

P

Parameter setting.....	35
Parameter setting CONDI.....	133
Parameter setting (Memosens COND).....	103
Parameter setting (Memosens ORP).....	69
Parameter setting (Memosens OXY).....	83
Parameter setting (Memosens PH).....	43
Parameter setting of Unical 9000.....	177
Parameter setting of Uniclean 900.....	208
Parameter setting, overview.....	281
Parameter setting, system forecast.....	200
Parking (program flow Unical 9000).....	184
Parking (program flow Uniclean 900).....	214
Park program (Unical 9000).....	183

Index

Park program (Uniclean 900)	213
Passcode entry	30
Passcode lost.....	30
pH: range and presetsings	45
pH value calculation.....	111
Plug & Measure	175
Precalibrated sensors (COND).....	117
Precalibrated sensors (CONDI)	141
Precalibrated sensors (OXY)	87
Precalibrated sensors (PH)	52
Pressure correction (OXY)	85
Probe control	173, 176
Probe control, icons.....	305
Probe controller connection	174
Probe control (menu).....	209
Probe control, menu (Unical 9000).....	178
Probe maintenance	225
Probe travel profile	199
Probe (Unical 9000)	195
Probe (Uniclean 900).....	222
Probe wear.....	228
Product calibration (COND).....	126
Product calibration (CONDI).....	150
Product calibration (PH).....	60
Product calibration (Sat) (OXY)	96
ProgaLog 3000 software.....	37
Program flow: Cal 1point (continuous), media monitoring off.....	182
Program flow: Cal 1point (short-time), media monitoring off	187
Program flow: Cal 2point (continuous), media monitoring off.....	181
Program flow: Cal 2point (short-time), media monitoring off	186
Program flow: Cleaning, continuous (Unical 9000)	180
Program flow: Cleaning, continuous (Uniclean 900)	212
Program flow: Measurement, short-time (Unical 9000).....	185
Program flow: Measurement, short-time (Uniclean 900).....	215
Program flow: Parking (Unical 9000)	184
Program flow: Parking (Uniclean 900).....	214
Program flow: Rinsing, continuous (Uniclean 900)	211
Program flow: Service (Unical 9000)	188
Program flow: Service (Uniclean 900).....	216

Index

Program flows (Unical 9000)	180
Program flows (Uniclean 900)	211
Program name assignment (Unical 9000)	189
Protective wiring of relay contacts	164

Q

Quick access	306
--------------------	-----

R

Reduced limit (USP)	110
Reference profile "Auto" (system forecast)	201
Reference profiles, messages	204
Reference profile "User" (system forecast)	202
Relay contacts, protective wiring	164
Relay contacts, Sensoface messages	166
Relay contacts, usage	165
Relay output, limit value	168
Release (softkey function)	34
Replacing the front module	20
Return of products under warranty	2
Rinse contact	167
Rinse water (Unical 9000)	196
Rinsing, continuous (program flow Uniclean 900)	211
RS-485 interfaces	25, 26

S

Safety information	14
Salinity correction (OXY)	85
Salt solution, concentration curves	108, 138
Screw clamp connector	261
SE 670 sensor, parameter setting	133
Sealing	20
Sealing water (Unical 9000)	195
Sealing water (Uniclean 900)	222
Secondary displays	31, 238
Second channel for Memosens sensors	27
Select measurement procedure (Unical 9000)	192
Select measurement procedure (Uniclean 900)	219
Sensoface	166
Sensoface (COND)	104
Sensoface (CONDI)	134

Index

Sensoface (ORP).....	70
Sensoface (OXY)	84
Sensoface (PH).....	44
Sensor data (COND).....	104
Sensor data (CONDI)	134
Sensor data (ORP)	70
Sensor data (OXY)	84
Sensor data (PH)	44
Sensor detection (Unical 9000).....	195
Sensor detection (Uniclean 900)	222
Sensor maintenance (OXY).....	100
Sensor monitor, diagnostics (COND)	131
Sensor monitor, diagnostics (CONDI)	155
Sensor monitor, diagnostics (ORP)	78
Sensor monitor, diagnostics (OXY).....	101
Sensor monitor, diagnostics (PH).....	66
Sensor monitoring details (COND)	104
Sensor monitoring details (ORP)	70
Sensor monitoring details (OXY).....	84
Sensor monitoring details (PH).....	44
Sensor monitor, maintenance (COND).....	130
Sensor monitor, maintenance (CONDI).....	154
Sensor monitor, maintenance (ORP).....	76
Sensor monitor, maintenance (OXY).....	100
Sensor monitor, maintenance (PH).....	64
Sensor network diagram (OXY)	102
Sensor network diagram (PH).....	67
Sensor wear monitor (OXY).....	102
Sensor wear monitor (PH).....	67
Serial number	16
Service (program flow Unical 9000).....	188
Service (program flow Uniclean 900)	216
Settings documentation.....	35
Short description.....	18
Signaling active parameter set via relay contact	170
Single-step control (Unical).....	227
Slot for SmartMedia card.....	20
SmartMedia card	20
Sodium hydroxide solution, concentration curves	107, 137
Softkeys.....	31

Index

Softkeys, function control.....	238
Software version.....	16
Specifiable buffer sets.....	279
Specifications.....	260
Start (4 mA) and end (20 mA).....	158
Start program (Unical).....	227
Start-up (Unical parameter setting).....	197
Start-up (Uniclean parameter setting).....	223
Statistics.....	235
Sulfuric acid, concentration curves.....	106, 136
Switching parameter sets via OK2.....	170
System components function block.....	171
System forecast.....	198
System forecast messages.....	249
System forecast, messages.....	204
System forecast, parameter setting.....	200
System forecast, probe travel profiles.....	199
System forecast, reference profiles.....	201
System forecast, SmartMediaCard.....	206
System forecast, tolerances.....	203

T

Table of contents.....	4
TAN.....	28
TC process medium (PH).....	47
Temperature compensation during calibration (COND).....	119
Temperature compensation during calibration (CONDI).....	143
Temperature compensation during calibration (PH).....	53
Temperature compensation (PH).....	48
Temperature dependence of reference systems measured against SHE.....	75
Temp probe adjustment (COND).....	130
Temp probe adjustment (CONDI).....	154
Temp probe adjustment (ORP).....	76
Temp probe adjustment (OXY).....	100
Temp probe adjustment (PH).....	64
Terminal assignments Memosens.....	26
Terminal compartment.....	21
Terminal plate.....	20, 22
Three-point calibration (PH).....	52
Time control: Fixed interval (Unical 9000).....	179

Index

Time control: Fixed interval (Uniclean 900).....	210
Time control (Unical 9000).....	178
Time control (Uniclean 900).....	209
Time control: Week program (Unical 9000).....	179
Time control: Week program (Uniclean 900).....	210
Tolerance adjustment menu (PH).....	45
Tolerance adjustment (PH).....	68
Tolerance specifications, system forecast.....	203
Trademarks.....	2
Travel behavior of retractable fittings.....	198
Two-point calibration (PH).....	52

U

Unical 9000 connection.....	174
Unical 9000, overview of parameter setting.....	287
Unical 9000, quick access.....	307
Unical diagnostics.....	236
Unical error messages.....	250
Unical network diagram.....	236
Unical parameter setting.....	177
Unical status.....	236
Uniclean 900 connection.....	174
Uniclean 900, quick access.....	306
Uniclean diagnostics.....	237
Uniclean error messages.....	256
Uniclean parameter setting.....	208
Uniclean status.....	237
USP function.....	110

V



















Viewing level.....	33
--------------------	----













W

Wait position (program flow Unical 9000).....	183
Wait position (program flow Uniclean 900).....	213
Week program (Unical 9000).....	179
Week program (Uniclean 900).....	210

Z

Zero correction (CONDI).....	153
Zero correction (OXY).....	99

Icon	Explanation of icons important for the FIU 3400-141 module
	The analyzer is in measuring mode.
 	The analyzer is in calibration mode. HOLD mode active for the currently calibrated module.
 	The analyzer is in maintenance mode. HOLD mode active.
 	The analyzer is in parameter setting mode. HOLD mode active.
	The analyzer is in diagnostics mode.
NAMUR signals   	<p>HOLD. The NAMUR "HOLD" contact is active (factory setting: Module BASE, Contact K2, N/O contact). Current outputs as configured:</p> <ul style="list-style-type: none"> • Current meas.: The currently measured value appears at the current output • Last usable value: The last measured value is held at the current output • Fix 22 mA: The output current is at 22 mA <p>Failure: The NAMUR "failure" contact is active (factory setting: Module BASE, Contact K4, N/C contact). To view error message, access: Diagnostics menu/Message list</p> <p>Maintenance: The NAMUR "maintenance request" contact is active (factory setting: Module BASE, Contact K2, N/O contact). To view error message, access: Diagnostics menu/Message list</p>
 man	Temperature by manual input
	Calibration is performed (progress display)
	Calibration - Step 1 of product calibration has been executed. The analyzer is waiting for the sample values.
TC	Temperature compensation for process medium is active (Linear/Ultrapure water/Table)
Δ	Delta function is active (Output value = measured value – delta value)
	In the plaintext display in front of a menu line: Access to next menu level with enter
	In the plaintext display in front of a menu line when it has been blocked by the Administrator against access from the Operator level.
	Designates the module slot (1, 2, or 3), allowing the clear assignment of measured-value/parameter displays in the case of identical module types.
	Indicates the active parameter set (The analyzer provides two parameter sets A and B. Up to 5 sets can be added using additional functions and SmartMedia card.)

Icon	Explanation of icons important for the probe control
	The probe is in MEASURE position ("PROCESS")
	The probe is in SERVICE position
	Rinse water active
	Metering pump at media adapter port I active.
	Metering pump at media adapter port II active.
	Metering pump at media adapter port III active.
	Additional medium 1 activated
	Additional medium 2 activated
	Valve at port III active
	Probe in SERVICE position
	Probe changes position
	Probe in MEASURE position ("PROCESS")

Quick Access

Functions for Uniclean 900 Controller



Uniclean 900 parameter setting	208
Time control (fixed interval / week program).....	209
Week program.....	210
Parameter setting: Program flows.....	211
Rinse program	211
Cleaning program	212
Park program	213
Measuring program, short-time	215
Service program	216
Parameter setting: Installation	218
Control via process control system	220
Start-up	223
System forecast.....	198



Uniclean 900 diagnostics.....	237
--------------------------------------	------------

Quick Access

Functions for Unical 9000 Controller



Unical 9000 parameter setting	177
Time control (fixed interval / week program).....	178
Week program.....	179
Parameter setting: Program flows.....	180
Park program	183
Service program:	188
Parameter setting: Installation	191
Control via process control system	193
Configuring Media Monitoring	196
System forecast.....	198



Probe maintenance	225
Manual control	226
Single step control.....	227
Probe wear.....	228



Unical 9000 diagnostics	236
--------------------------------------	------------

Quick Access

General Parameter Setting



Parameter setting	33
Documenting.....	35
Memosens PH.....	43
Memosens ORP	69
Memosens OXY.....	83
Memosens COND.....	103
Calculation Blocks.....	113
CONDI (Sensor SE 670).....	133
Logbook.....	157
Factory setting	157
BASE module	158
Current outputs	158
Relay contacts.....	165
Rinse contact	167
OK1, OK2 inputs.....	169
Parameter set selection	170



Diagnostics	229
Memosens PH.....	65
Memosens ORP	77
Memosens OXY.....	101
Memosens COND.....	131
CONDI (Sensor SE 670).....	155



091982