

Stratos Multi E471N Industrial Transmitter

EtherNet/IP™

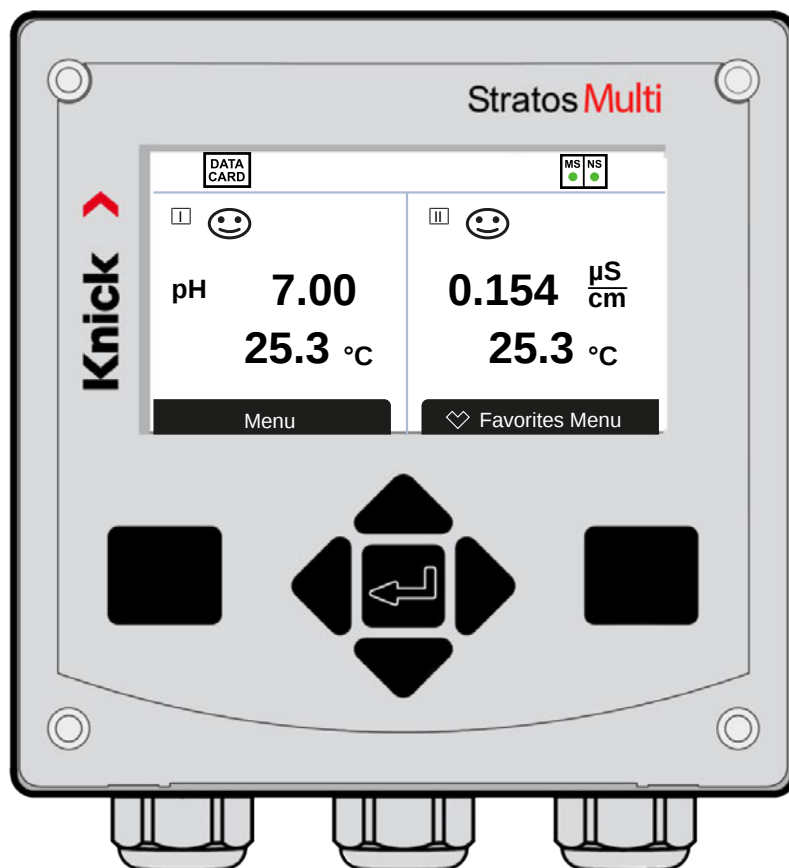

Supplemental Directives

READ AND SAVE THIS DOCUMENT FOR FUTURE REFERENCE. BEFORE ATTEMPTING TO ASSEMBLE, INSTALL, OPERATE OR MAINTAIN THE PRODUCT, PLEASE ENSURE A COMPLETE UNDERSTANDING OF THE INSTRUCTIONS AND RISKS DESCRIBED HEREIN. ALWAYS OBSERVE ALL SAFETY INFORMATION. FAILURE TO COMPLY WITH INSTRUCTIONS IN THIS DOCUMENT COULD RESULT IN SERIOUS INJURY AND/OR PROPERTY DAMAGE. THIS DOCUMENT IS SUBJECT TO CHANGE WITHOUT NOTICE.



These supplemental directives explain how safety information is laid out in this document and what content it covers.

Safety Chapter

This document's safety chapter is designed to give the reader a basic understanding of safety. It illustrates general hazards and gives strategies on how to avoid them.

Warnings

This document uses the following warnings to indicate hazardous situations:

Icon	Category	Meaning	Remark
	WARNING!	Designates a situation that can lead to death or serious (irreversible) injury.	The warnings contain information on how to avoid the hazard.
	CAUTION!	Designates a situation that can lead to slight or moderate (reversible) injury.	
<i>Without</i>	NOTICE!	Designates a situation that can lead to property or environmental damage.	

Symbols Used in this Document





Icon	Meaning
	Reference to additional information
	Interim or final result in instructions for action
	Sequence of figures attached to an instruction for action
	Item number in a figure
(1)	Item number in text

Table of Contents

1 Safety	9
1.1 Intended Use	9
1.2 Personnel Requirements	9
1.3 Safety Training	9
1.4 Residual Risks	10
1.5 Installation and Commissioning.....	10
1.6 Operation.....	11
2 Product	12
2.1 Package Contents and Product Identification	12
2.1.1 Nameplate	13
2.2 Symbols and Markings on the Product.....	13
2.3 Design and Function.....	14
2.4 Product Line.....	15
2.5 System Overview.....	16
3 Installation	17
3.1 Enclosure Mounting Options.....	17
3.2 Mounting the Enclosure	17
3.3 Dimension Drawings	19
3.3.1 Wall Mounting.....	19
3.3.2 Pipe-Mount Kit ZU0274.....	21
3.3.3 Protective Hood for Wall and Pipe Mounting ZU0737/ZU1176	22
3.3.4 Panel-Mount Kit ZU0738	23
3.4 Blanking Plugs, Reduction Sealing Inserts, Multiple Sealing Inserts.....	24
3.5 Connections.....	25
3.6 Terminal Assignment.....	26
3.7 Electrical Installation.....	27
3.7.1 RJ45 Ethernet Socket Wiring	27
3.7.2 Installing Active and Passive Current Outputs.....	28
3.7.3 Relay Contacts: Protective Wiring.....	28
3.8 Sensor Connection	30
3.8.1 Connecting a Memosens Sensor/Optical Oxygen Sensor (LDO).....	30
3.8.2 Connecting an Analog Sensor/Second Memosens Channel.....	31
3.9 Terminal Assignments of Measuring Modules	32
4 Commissioning	34
5 Operation and Use	35
5.1 Changing the User Interface Language.....	35
5.2 Display and Keypad.....	35
5.3 Menu Structure Overview.....	38
5.4 Access Control.....	38
5.5 Operating States.....	38
5.6 Measurement Display.....	39

6	Parameter Setting	40
6.1	Operating Levels	40
6.2	Locking a Function	41
6.3	Parameter Setting Menus	42
6.4	System Control.....	42
6.4.1	Memory Card	43
6.4.2	Transfer Configuration.....	43
6.4.3	Parameter Sets.....	44
6.4.4	Function Control.....	45
6.4.5	Calculation Blocks (TAN Option FW-E020)	46
6.4.6	Time/Date.....	46
6.4.7	Measuring Point Description	46
6.4.8	Firmware Update (TAN Option FW-E106)	46
6.4.9	Option Activation	47
6.4.10	Logbook.....	47
6.4.11	Measurement Recorder (TAN Option FW-E103).....	47
6.4.12	Buffer Table (TAN Option FW-E002)	47
6.4.13	Concentration Table (TAN Option FW-E009)	48
6.4.14	Restore Factory Settings	48
6.4.15	Passcode Entry	48
6.5	Parameter Setting, General	48
6.5.1	Configuring the Measurement Display	49
6.5.2	Display	54
6.5.3	Measurement Recorder (TAN Option FW-E103).....	54
6.6	Inputs/Outputs	55
6.6.1	Current Outputs.....	55
6.6.2	Relay Contacts	58
6.6.3	Control Inputs.....	62
6.7	Sensor Selection [I] [II]	63
6.8	pH Process Variable	64
6.8.1	Sensor Data	67
6.8.2	Calibration Presettings	70
6.8.3	Temperature Compensation of Process Medium	71
6.8.4	Delta Function	71
6.8.5	Messages	72
6.9	ORP Process Variable	73
6.9.1	Sensor Data	74
6.9.2	Calibration Presettings	75
6.9.3	Delta Function	75
6.9.4	Messages	76
6.10	Conductivity (Contacting) Process Variable	77
6.10.1	Input Filter.....	78
6.10.2	Sensor Data	80
6.10.3	Calibration Presettings	82
6.10.4	Temperature Compensation of Process Medium	83
6.10.5	Concentration (TAN Option FW-E009).....	83
6.10.6	TDS Function.....	83
6.10.7	USP Function.....	84
6.10.8	Messages	85

6.11	Conductivity (Inductive) Process Variable	86
6.11.1	Sensor Data	88
6.11.2	Calibration Presettings	90
6.11.3	Temperature Compensation of Process Medium	90
6.11.4	Concentration (TAN Option FW-E009).....	91
6.11.5	TDS Function.....	91
6.11.6	USP Function.....	91
6.11.7	Messages	92
6.12	Dual Conductivity Measurement	93
6.13	Oxygen Process Variable	94
6.13.1	Sensor Data	97
6.13.2	Calibration Presettings	100
6.13.3	Pressure Correction	100
6.13.4	Salinity Correction.....	101
6.13.5	Messages	101
6.14	EtherNet/IP	102
6.14.1	Configuring the EIP Channel.....	102
6.14.2	Configuration with Studio 5000 Logix Designer®	102
6.14.3	Product Calibration with Studio 5000 Logix Designer®	104
6.14.4	Local Operation.....	105
6.14.5	Configuring the Measured Values	106
6.14.6	State	108
6.14.7	Diagnostics	108
6.14.8	Connections to the Controller	109
6.15	Flow.....	111
7	Calibration/Adjustment	112
7.1	Calibration/Adjustment Memosens	113
7.2	pH Process Variable Calibration/Adjustment.....	113
7.2.1	Explanations for pH Calibration/Adjustment.....	113
7.2.2	Calibration Procedure	114
7.2.3	Temperature Compensation during Calibration.....	115
7.2.4	Calibration/Adjustment Options	115
7.2.5	Calibration Mode: Calimatic	115
7.2.6	Calibration Mode: Manual.....	117
7.2.7	Calibration Mode: Product.....	118
7.2.8	Calibration Mode: Data Entry.....	119
7.2.9	Calibration Mode: ISFET Zero Point	120
7.2.10	Calibration Mode: Temperature	120
7.3	ORP Process Variable Calibration/Adjustment	121
7.3.1	Calibration/Adjustment Options	121
7.3.2	Calibration Mode: ORP Data Entry	121
7.3.3	Calibration Mode: ORP Adjustment.....	121
7.3.4	Calibration Mode: ORP Check.....	123
7.3.5	Calibration Mode: Temperature	123
7.4	Conductivity (Contacting) Process Variable Calibration/Adjustment.....	124
7.4.1	Explanations Regarding Calibration/Adjustment with 2-/4-Electrode Sensors	124
7.4.2	Temperature Compensation during Calibration.....	124
7.4.3	Calibration/Adjustment Options	125
7.4.4	Calibration Mode: Automatic.....	125
7.4.5	Calibration Mode: Manual.....	126
7.4.6	Calibration Mode: Product.....	127

7.4.7	Calibration Mode: Data Entry	129
7.4.8	Calibration Mode: Temperature	129
7.5	Conductivity (Inductive) Process Variable Calibration/Adjustment	130
7.5.1	Explanations Regarding Calibration/Adjustment with Toroidal Sensors	130
7.5.2	Temperature Compensation during Calibration	130
7.5.3	Calibration/Adjustment Options	131
7.5.4	Calibration Mode: Automatic	131
7.5.5	Calibration Mode: Manual	132
7.5.6	Calibration Mode: Product	133
7.5.7	Calibration Mode: Zero Point	135
7.5.8	Calibration Mode: Installation Factor	135
7.5.9	Calibration Mode: Data Entry	136
7.5.10	Calibration Mode: Temperature	136
7.6	Calibration/Adjustment Oxygen Process Variable	137
7.6.1	Explanations Regarding Oxygen Calibration/Adjustment	137
7.6.2	Calibration/Adjustment Options	137
7.6.3	Calibration Mode: In Air	138
7.6.4	Calibration Mode: In Water	139
7.6.5	Calibration Mode: Data Entry	140
7.6.6	Calibration Mode: Product	140
7.6.7	Calibration Mode: Zero Point	142
7.6.8	Calibration Mode: Temperature	142
8	Diagnostics.....	143
8.1	Diagnostics Functions	143
8.1.1	Overview of Diagnostic Functions	143
8.1.2	Message List	144
8.1.3	Logbook.....	145
8.1.4	Device Information	145
8.1.5	Device Test	146
8.1.6	Measuring Point Description	146
8.1.7	Channel I/II Diagnostic Functions	147
9	Maintenance Functions.....	149
9.1	Overview of Maintenance Functions	149
9.2	Channel I/II Maintenance Functions	150
9.2.1	Sensor Monitor	150
9.2.2	Autoclaving Counter	150
9.2.3	Electrolyte Replacement/Membrane Body Replacement	150
9.2.4	Replacing the Membrane Body/Interior Body.....	151
9.3	Manual Function Test	151
9.3.1	Current Source.....	151
9.3.2	Relay Test	151
10	Maintenance	152
11	Decommissioning.....	153
11.1	Disposal	153
11.2	Return Delivery	153

12 Troubleshooting	154
12.1 Failure Conditions	154
12.2 Messages	155
12.3 Sensocheck and Sensoface	178
13 Accessories	181
13.1 Memory Card	181
13.2 ZU1072 RJ45 Socket	184
13.3 ZU1073 Adapter Cable RJ45/M12 D-Type	185
14 TAN Options	186
14.1 pH Buffer Table: Entry of Individual Buffer Set (FW-E002)	186
14.2 Current Characteristic (FW-E006)	187
14.3 Concentration Determination (FW-E009)	187
14.3.1 Concentration Curves	189
14.4 Pfaunder Sensors (FW-E017)	192
14.5 Calculation Blocks (FW-E020)	194
14.6 Digital ISM-Sensors (FW-E053)	198
14.7 Parameter Sets 1-5 (FW-E102)	199
14.8 Measurement Recorder (FW-E103)	201
14.9 Logbook (FW-E104)	203
14.10 Firmware Update (FW-E106)	204
15 Specifications	205
15.1 Power Supply (Power)	205
15.2 Connections	205
15.2.1 Inputs (SELV, PELV)	205
15.2.2 Outputs (SELV, PELV)	205
15.2.3 Relay Contacts	206
15.3 Device	207
15.4 Ambient Conditions	208
15.5 Compliance	208
15.6 Interfaces	208
15.7 Measurement Functions	209
15.7.1 pH	209
15.7.2 Conductivity (Contacting)	211
15.7.3 Conductivity (Inductive)	212
15.7.4 Conductivity (Dual)	213
15.7.5 Temperature Compensation (Conductivity)	214
15.7.6 Concentration Determination, Conductivity (TAN Option FW-E009)	214
15.7.7 Oxygen	215
15.8 Diagnostics and Statistics	217

16 Appendix.....218

- 16.1 Channel II Wiring Examples 218
 - 16.1.1 pH Analog Wiring Examples 218
 - 16.1.2 ORP Analog Wiring Example 224
 - 16.1.3 ISM pH Wiring Example 225
 - 16.1.4 Contacting Conductivity Wiring Examples 226
 - 16.1.5 Inductive Conductivity Wiring Examples 233
 - 16.1.6 Dual Conductivity Wiring Examples 235
 - 16.1.7 Oxygen Wiring Examples 238
- 16.2 Symbols and Markings on the Display 241

17 Abbreviations243

1 Safety

This document contains important instructions for the use of the product. Always follow all instructions and operate the product with caution. If you have any questions, please contact Knick Elektronische Messgeräte GmbH & Co. KG (hereinafter sometimes referred to as “Knick”) using the information provided on the back page of this document.

1.1 Intended Use

Stratos Multi E471N is an industrial transmitter in 4-wire technology for EtherNet/IP communication. It features an RJ45 socket and can therefore be connected in a star topology. In the field of liquid analysis, the device can measure pH values, ORP, conductivity (contacting or inductive), and oxygen content, both dissolved and in the gaseous phase.

Alongside a permanently installed measuring channel I for Memosens sensors, the modular transmitter has a slot that can be equipped with analog or digital measuring modules (measuring channel II). The transmitter can be extended with device-specific add-on functions called TAN options.

The defined rated operating conditions must be observed when using this product.

→ *Specifications, p. 205*

USE CAUTION AT ALL TIMES WHEN INSTALLING, USING, OR OTHERWISE INTERACTING WITH THE PRODUCT. ANY USE OF THE PRODUCT EXCEPT AS SET FORTH HEREIN IS PROHIBITED, AND MAY RESULT IN SERIOUS INJURY OR DEATH, AS WELL AS DAMAGE TO PROPERTY. THE OPERATING COMPANY SHALL BE SOLELY RESPONSIBLE FOR ANY DAMAGES RESULTING FROM OR ARISING OUT OF AN UNINTENDED USE OF THE PRODUCT.

All designations such as “device,” “product,” “industrial transmitter,” or “transducer” refer to the Stratos Multi E471N.

Devices Not Intended for Use in Hazardous Locations

Devices identified with an N in the product name must not be used in hazardous locations.

1.2 Personnel Requirements

The operating company shall ensure that any personnel using or otherwise interacting with the product is adequately trained and has been properly instructed.

The operating company shall comply and cause its personnel to comply with all applicable laws, regulations, codes, ordinances, and relevant industry qualification standards related to product. Failure to comply with the foregoing shall constitute a violation of operating company’s obligations concerning the product, including but not limited to an unintended use as described in this document.

1.3 Safety Training

Upon request, Knick Elektronische Messgeräte GmbH & Co. KG will provide safety briefings and product training during initial commissioning of the product. More information is available from the relevant local contacts.

1.4 Residual Risks

The product has been developed and manufactured in accordance with generally accepted safety rules and regulations. The following residual risks remain:

- Ambient conditions with chemically corrosive substances may prevent the system from working properly.
- If access to the operator and administrator levels of the **Parameter Setting** menu is not protected by passcodes, faulty operation may occur.

1.5 Installation and Commissioning

Adhere to all applicable national and local regulations and standards for the installation of electrical equipment. Information on installation is provided in the installation guide Stratos Multi.

Comply with the points below during installation and commissioning:

- The device must be installed in a stationary position by a licensed electrician in compliance with the regulations and standards that apply at the installation site.
- Avoid notches when stripping the wires.
- The device must be commissioned by authorized, qualified personnel, and it must be fully configured.

Cable

Only use cables with a suitable temperature resistance.

Cable temperature resistance: > 75 °C (> 167 °F)

Mains Connection

The device does not have a power switch. An appropriately arranged and accessible disconnecting for the device must be present in the system installation. The disconnecting device must disconnect all non-grounded, current-carrying wires. The disconnecting device must be labeled in such a way that enables the associated device to be identified.

The power cord may carry dangerous touch voltages. Touch protection must be ensured by proper installation.

Inputs and Outputs (SELV, PELV)

All inputs and outputs must be connected to SELV/PELV circuits.

Degree of Protection

The device housing is dust-tight and offers complete protection against contact as well as against strong water jets.

- Europe: IP protection IP66/IP67
- USA: TYPE 4X Outdoor (with pressure compensation)

1.6 Operation

Whenever it is likely that protection has been impaired, the device must not be switched on or the device must be switched off correctly and secured against unintended operation. Reasons for this could be:

- Visible damage to the device
- Failure of the electrical function

Before recommissioning the device, a professional routine test must be performed by the manufacturer.

Manipulations of the device other than the handling described in the user manual are not permitted.

Relay Contacts

The permissible load capability of the relay contact must not be exceeded, even during switching operations. The relay contacts are subject to electrical erosion, which reduces their service life under inductive and capacitive loads.

2 Product

2.1 Package Contents and Product Identification

- Stratos Multi basic unit (front unit and rear unit)
- Bag containing small accessory parts (2x plastic sealing plugs, 1x hinge pin, 1x plate for conduits, 2x insertable jumpers, 1x reduction sealing insert, 1x multiple sealing insert, 2x blanking plugs, 5x cable glands, and M20x1.5 hexagon nuts)
- Test report 2.2 according to EN 10204
- Installation Guide
- Safety Guide

Note: The user manual (this document) is published electronically. → knick-international.com

Note: Check all components for damage upon receipt. Do not use damaged parts.

Measuring modules are not included in the basic unit's package contents.

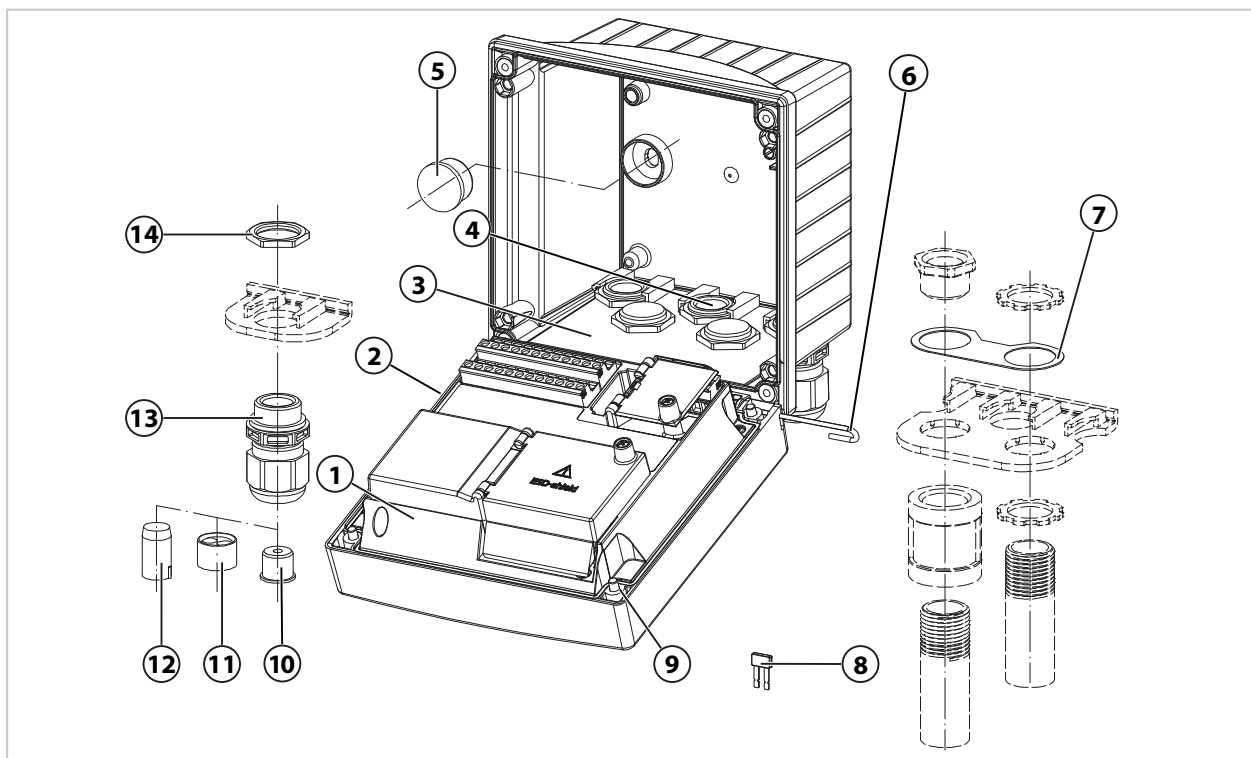

1 Front unit	8 Insertable jumper (2x)
2 Circumferential seal	9 Enclosure screw (4x)
3 Rear unit	10 Reduction sealing insert (1x)
4 Holes for cable glands	11 Multiple sealing insert (1x)
5 Plastic sealing plug (2x), for sealing in case of wall mounting	12 Blanking plug (2x)
6 Hinge pin (1x), insertable from either side	13 Cable gland (5x)
7 Plate (1x), for conduit mounting: Place washer between enclosure and union	14 Hexagon nut (5x)

2.1.1 Nameplate

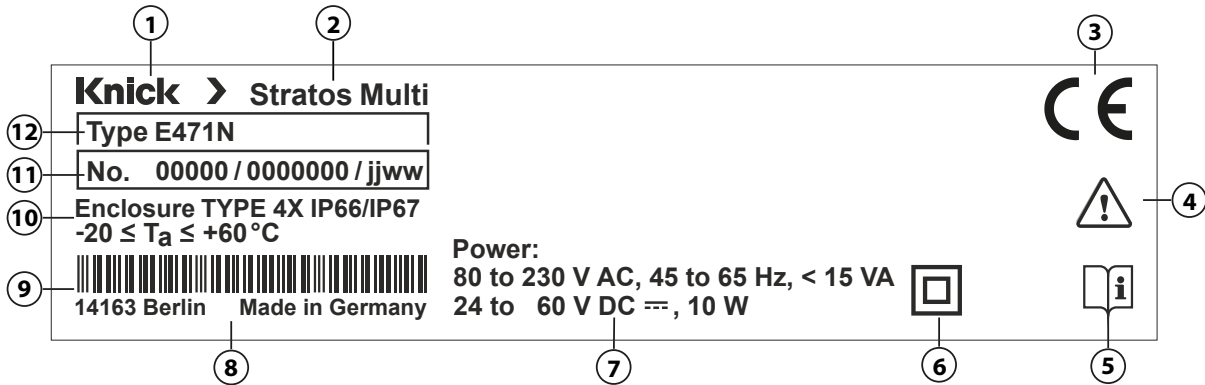

1	Manufacturer	7	Power supply
2	Product name	8	Manufacturer address with designation of origin
3	CE mark	9	Barcode: Product number, serial number, check digit
4	Special conditions and danger points	10	Degree of protection, permissible ambient temperature
5	Reminder to read the documentation	11	Product number/serial number/production year and week
6	Protection class II	12	Model designation

Note: The MAC address (00:19:10:xx:xx:xx) is located on a separate label.

You can view the device type, serial number, and firmware, hardware, and bootloader versions of your device in the Diagnostics menu: [Menu Selection](#) ▶ [Diagnostics](#) ▶ [Device Information](#)

→ *Device Information, p. 145*

2.2 Symbols and Markings on the Product

	CE mark
	Special conditions and danger points! Observe the safety instructions and instructions on safe use of the product as outlined in the product documentation.
	Reminder to read the documentation
	Protection class II

2.3 Design and Function

Basic Variant

Communication via EtherNet/IP

1 measuring channel for a Memosens sensor or digital optical oxygen sensor

Door contact

2 freely assignable relay contacts

for NAMUR messages (Failure, Maintenance Required, Out of Specification, Function Check), set-point alarm relay, controller, rinse contact, parameter set, USP (for conductivity), Sensoface

1 control input

2 current outputs ¹⁾

Flow measurement

Additional functions (TAN options) can be enabled by entering a transaction number (TAN).

→ *TAN Options, p. 186*

The measuring modules enable an analog sensor to be connected or 2-channel measurement.

Version	Possible Combinations
1-channel	1x Memosens sensor
	1x SE740 optical oxygen sensor
	1x analog sensor via measuring module (MK module)
	1x digital ISM sensor via measuring module (MK module) and TAN option FW-E053
2-channel	2x Memosens sensors (1x via MK-MS module)
	1x Memosens sensor (MK-MS module) and 1x SE740 optical oxygen sensor
	1x Memosens sensor and 1x analog sensor via measuring module (MK module)
	1x Memosens sensor and 1x digital ISM sensor via measuring module (MK module) and TAN option FW-E053
	Dual conductivity measurement (MK-CC module)

Parameter Sets

Two complete parameter sets (A, B) can be stored in the device. The control element for switching between the parameter sets (optocoupler input OK1, softkey) is selected in the system control.

The currently activated set can be signaled by a relay contact.

Power Supply

Power is provided by an integrated broad-range power supply. → *Specifications, p. 205*

¹⁾ Not with activated EtherNet/IP communication

2.4 Product Line

Device (Digital Basic Unit)	Order No.
Stratos E471N	E471N
Measuring Modules for Analog or ISM Sensors¹⁾ or 2nd Channel Memosens, Non-Ex	
pH value, ORP measurement	MK-PH015N
Oxygen measurement	MK-OXY046N
Contacting conductivity measurement (wetted)	MK-COND025N
Inductive conductivity measurement	MK-CONDI035N
Dual conductivity measurement	MK-CC065N
Memosens Multiparameter (for 2-channel version)	MK-MS095N

Accessories → *Accessories, p. 181*

Add-on functions (TAN Options) → *TAN Options, p. 186*

¹⁾ ISM with TAN option FW-E053

2.5 System Overview

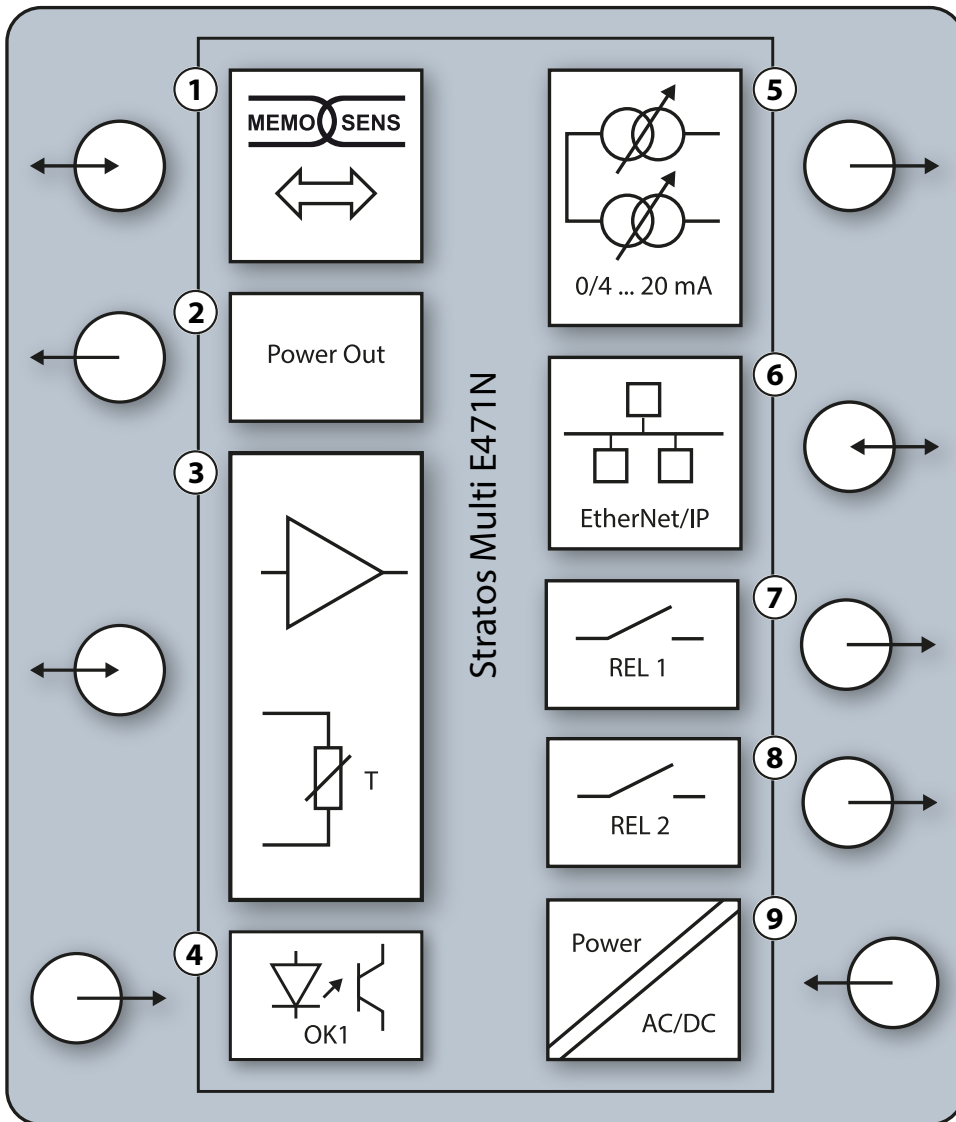

1 Input for Memosens sensors or SE740 optical oxygen sensor	6 EtherNet/IP interface
2 Power output 3/15/24 V for SE740 optical oxygen sensor or external transmitter	7 Relay contact K1: Messages, limits, rinse contact, ...
3 Port for an analog MK module or Memosens via MK-MS module	8 Relay contact K2: Messages, limits, rinse contact, ...
4 Octocoupler input OK1: Parameter set selection A/B, flow, ...	9 Power input: 80 ... 230 V AC/24 ... 60 V DC < 15 VA/10 W
5 Current output 1, 2: Active or passive	

Note: EtherNet/IP and the current outputs may not be used at the same time.

3 Installation

3.1 Enclosure Mounting Options

Knockouts in the rear unit enable different mounting options:

- Wall mounting → *Dimension Drawings, p. 19*
- Pipe mounting → *Pipe-Mount Kit ZU0274, p. 21*
- Panel mounting → *Panel-Mount Kit ZU0738, p. 23*
- Protective hood → *Protective Hood for Wall and Pipe Mounting ZU0737/ZU1176, p. 22*

Cable glands for connecting sensors:

- 3 knockouts for M20x1.5 cable glands
→ *Blanking Plugs, Reduction Sealing Inserts, Multiple Sealing Inserts, p. 24*
- 2 knockouts for M20x1.5 or NPT 1/2" cable glands or rigid metallic conduit

3.2 Mounting the Enclosure

⚠ CAUTION! Risk of losing the specified ingress protection. Observe the permissible cable diameters and tightening torques. Fasten the cable glands and screw together the enclosure correctly. Do not contaminate or damage the circumferential seal.

NOTICE! Possible product damage. Use only a suitable Phillips head screwdriver to open and close the enclosure. Do not use sharp or pointed objects. Tighten the screws with a torque of 0.5 ... 2 Nm.

Note: Install the hinge pin to prevent tensile strain on the measuring cables when replacing the front unit. Imprecise measured values may result if this is not done.

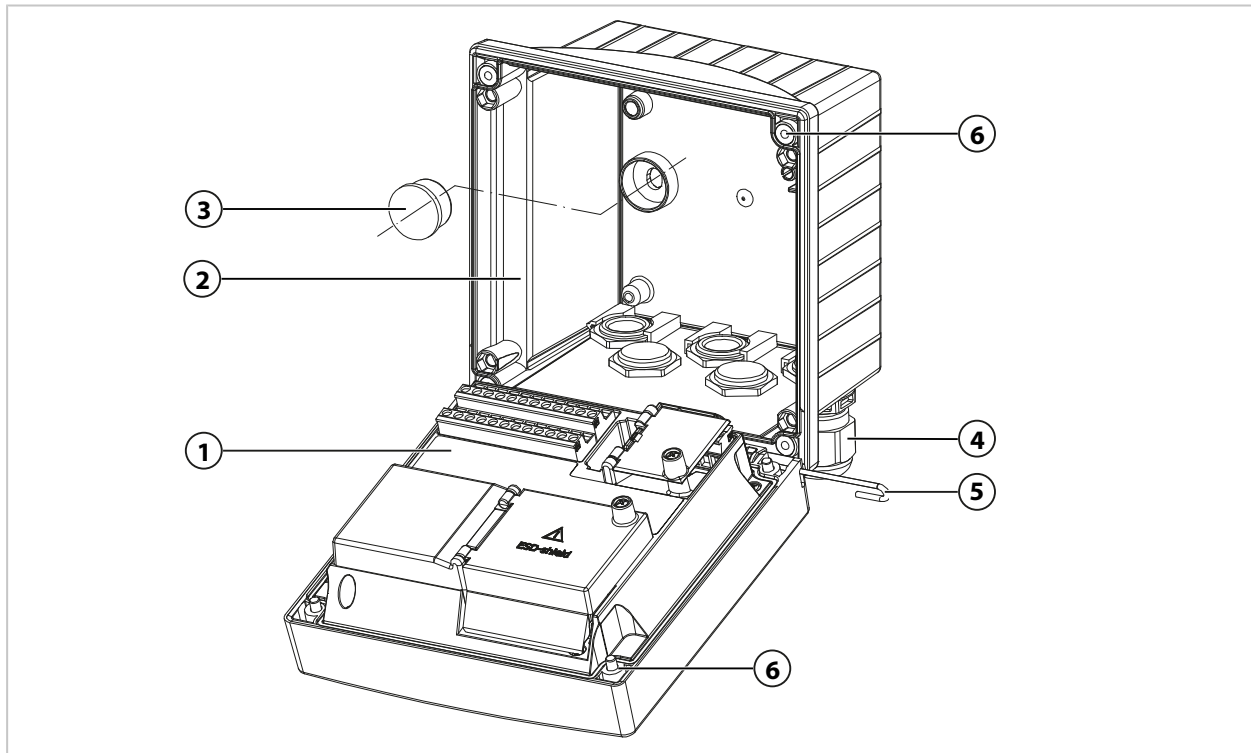

01. Select mounting type and install.

- ✓ Wall mounting → *Wall Mounting, p. 19*
- ✓ Pipe mounting → *Pipe-Mount Kit ZU0274, p. 21*
- ✓ Panel mounting → *Panel-Mount Kit ZU0738, p. 23*

02. Following wall mounting, seal the holes with plastic sealing plugs **(3)**.

03. Install the cable glands **(4)** from the bag containing small accessory parts in the rear unit.
 - *Package Contents and Product Identification, p. 12*
 - *Blanking Plugs, Reduction Sealing Inserts, Multiple Sealing Inserts, p. 24*
04. Guide the required cables through.
05. Seal unused cable glands with blanking plugs.
06. Insert the hinge of the front unit **(1)** into the rear unit **(2)** and connect both parts with the hinge pin **(5)**.
07. Insert module if required. → *Connecting an Analog Sensor/Second Memosens Channel, p. 31*
08. Connect the cables.
 - *Electrical Installation, p. 27*
 - *Connecting a Memosens Sensor/Optical Oxygen Sensor (LDO), p. 30*
09. Open the front unit and tighten the captive enclosure screws **(6)** on the front of the front unit **(1)** in diagonal sequence using a Phillips head screwdriver. Tightening torque 0.5 ... 2 Nm

3.3 Dimension Drawings

3.3.1 Wall Mounting

Note: All dimensions are listed in millimeters [inches].

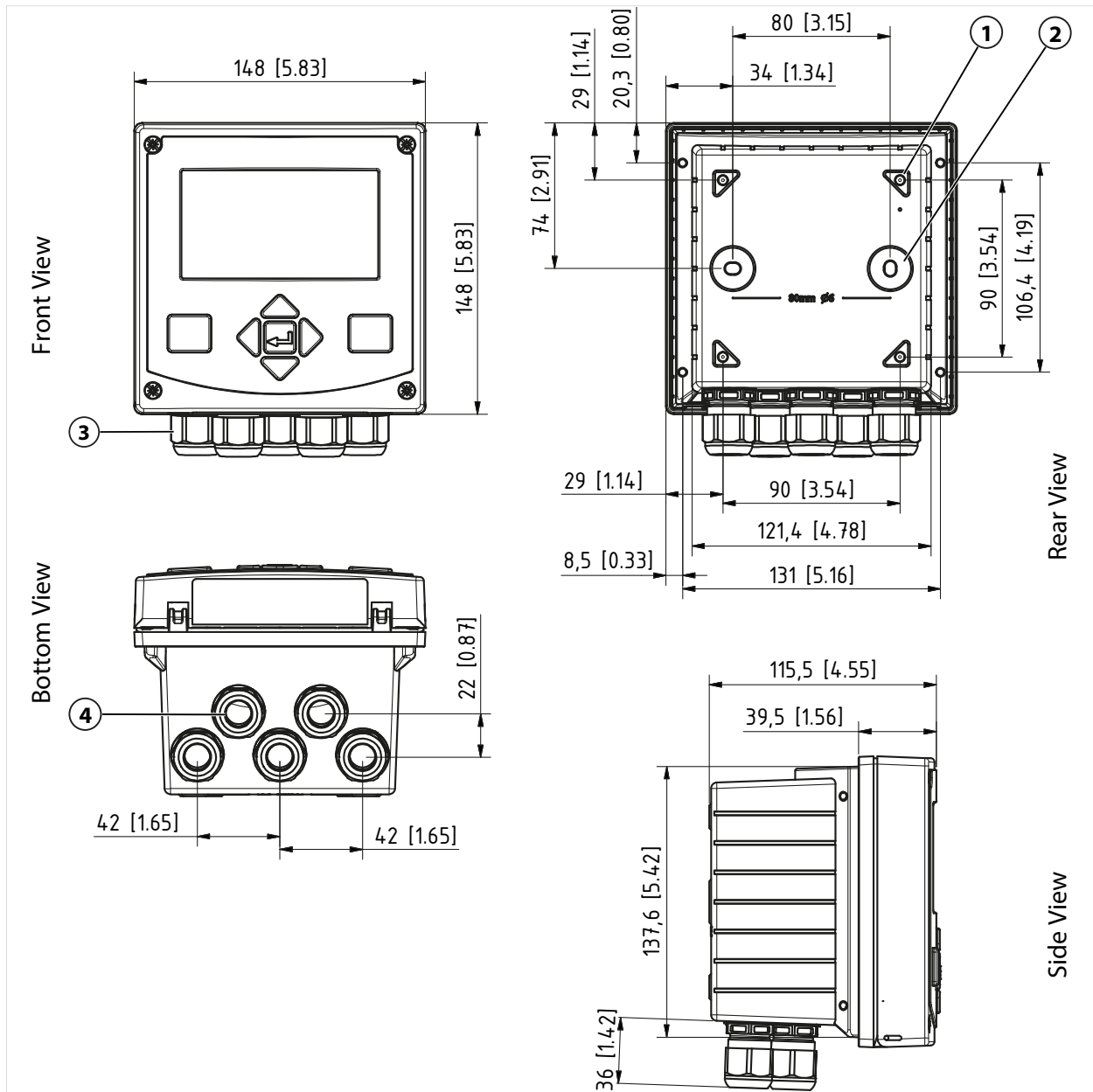

- | | |
|---|---|
| 1 Holes for pipe mounting, 4x | 3 Cable glands, 5x |
| 2 Holes for wall mounting, 2x
Sealing with plastic sealing plugs | 4 Holes for cable glands or 1/2" conduit, ø 21.5 mm, 2x |

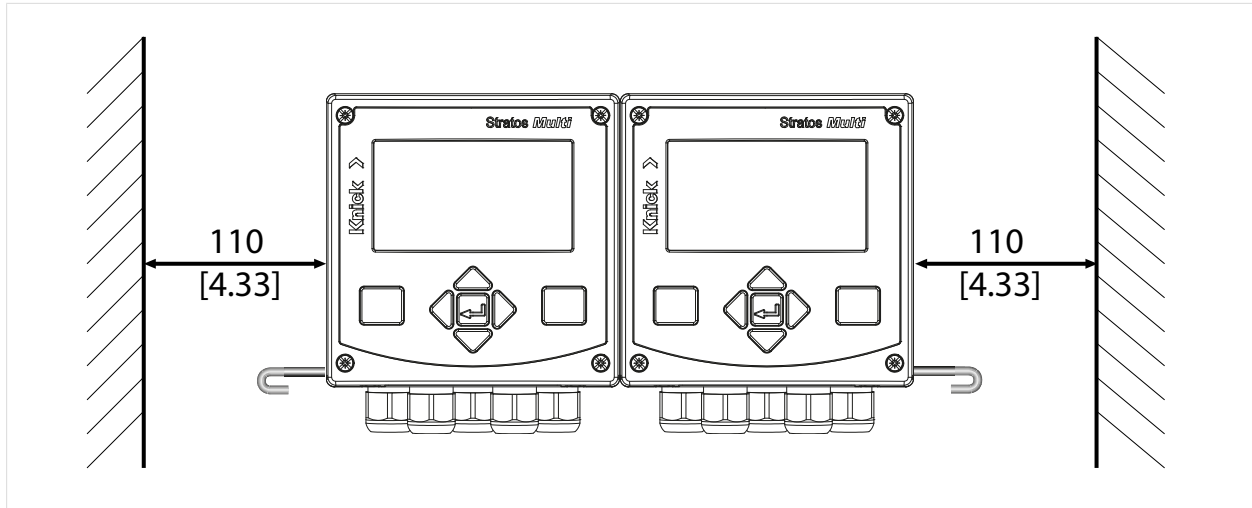
Mounting Clearance

There is a 100 mm hinge pin in the bag containing small accessory parts included in the package contents → *Package Contents and Product Identification*, p. 12. The hinge pin connects the front and rear units. Depending on space requirements, the hinge pin can be inserted on the left or right. In order to replace the front unit, a minimum clearance of 110 mm [4.33 inches] must be maintained on the relevant side.

3.3.2 Pipe-Mount Kit ZU0274

Note: All dimensions are listed in millimeters [inches].

Pipe dimensions:

Diameter 40 ... 60 mm [1.57 ... 2.36"] or edge length 30 ... 45 mm [1.18 ... 1.77"]

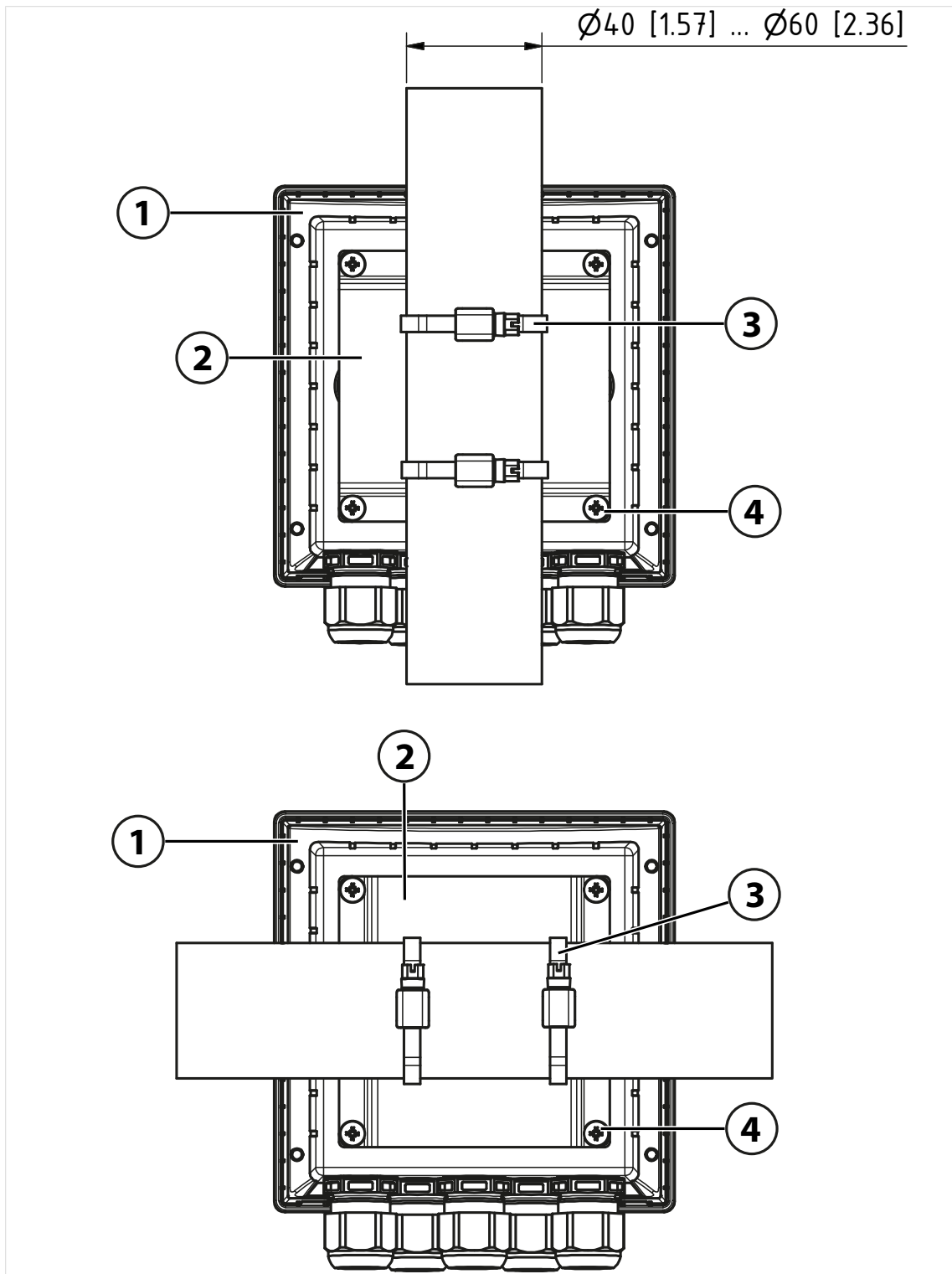

1 For either vertical or horizontal posts or pipes

3 Hose clamp with worm gear drive according to DIN 3017, 2x

2 Pipe-mount plate, 1x

4 Self-tapping screw, 4x

3.3.3 Protective Hood for Wall and Pipe Mounting ZU0737/ZU1176

ZU0737: Stainless steel A2

ZU1176: Stainless steel 1.4401

Note: Use only for wall or pipe mounting

Note: All dimensions are listed in millimeters [inches].

Wall Mounting

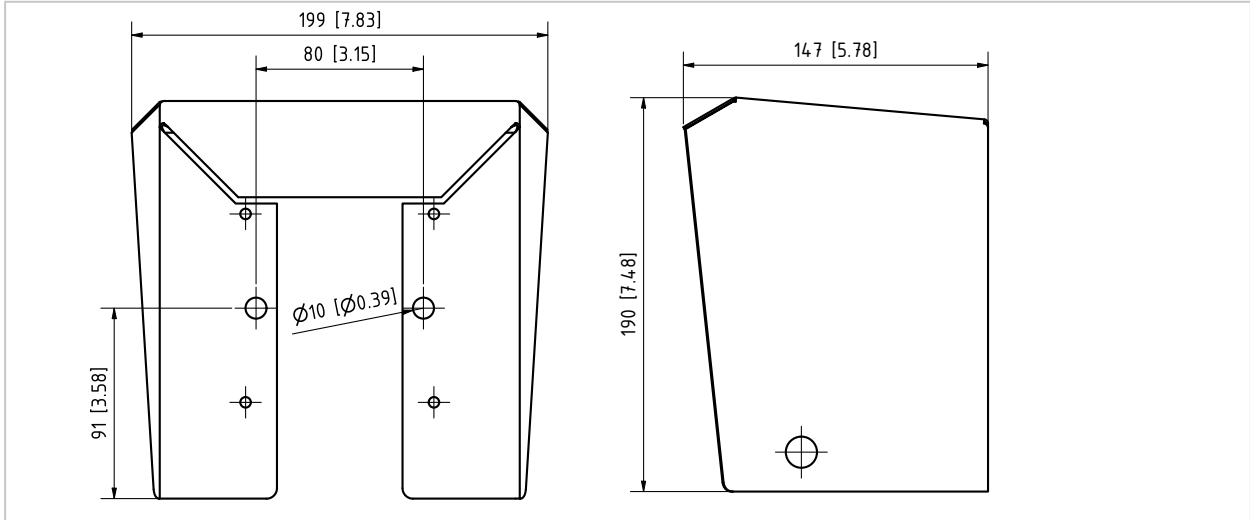

Pipe Mounting

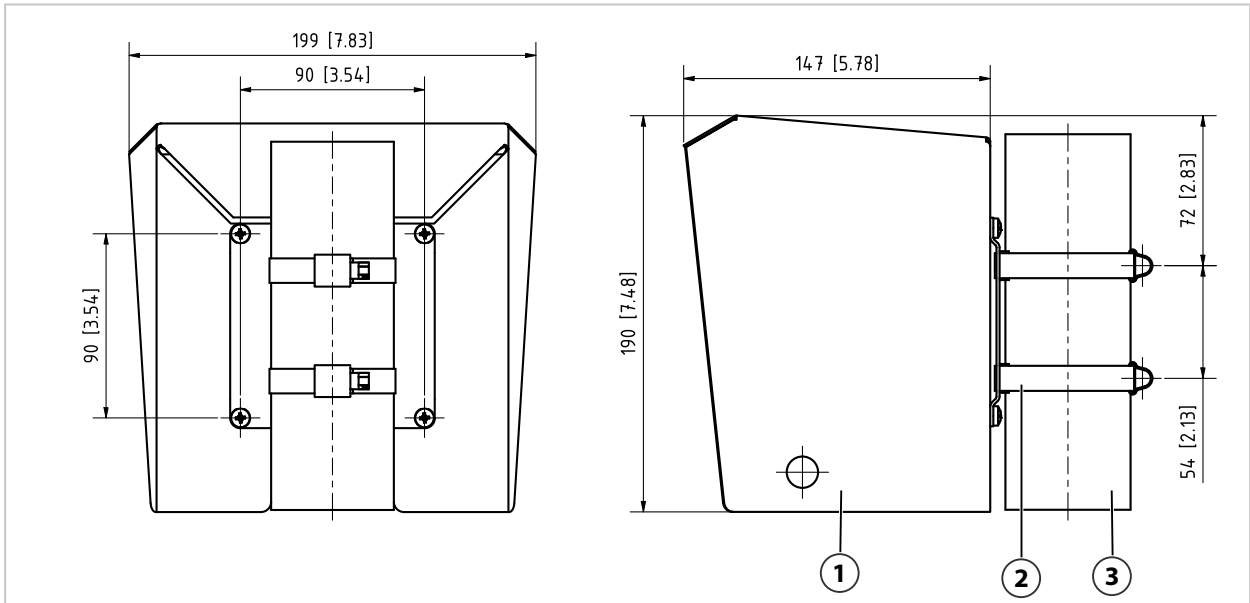

1 Protective hood ZU1176

2 Pipe-mount kit ZU0274

3 Pipe

3.3.4 Panel-Mount Kit ZU0738

Note: All dimensions are listed in millimeters [inches].

Cutout 138 mm x 138 mm (DIN 61554)

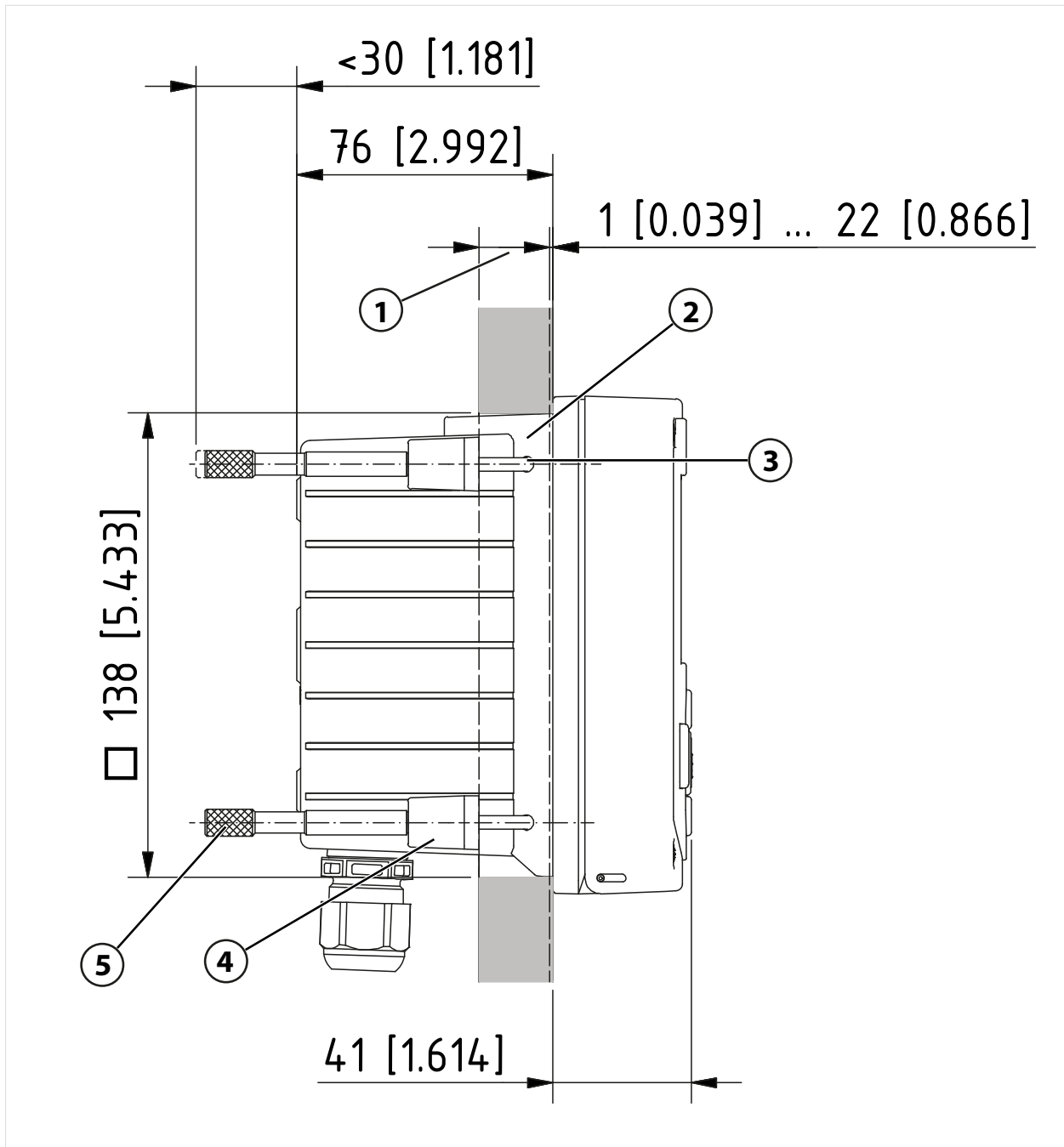

1 Control panel	4 Locking bar, 4x
2 Circumferential seal, 1x	5 Threaded sleeve, 4x
3 Screw 60.0 x 4.0 mm, 4x	

3.4 Blanking Plugs, Reduction Sealing Inserts, Multiple Sealing Inserts

As delivered, each cable gland includes a standard sealing insert. Reduction sealing inserts and multiple sealing inserts are available for the tight insertion of one or two thinner cables. The clasp can be tightly sealed using a blanking plug. Proceed as shown below.

⚠ CAUTION! Risk of losing the specified ingress protection. Fasten the cable glands and screw together the enclosure correctly. Observe the permissible cable diameters and tightening torques. Only use original accessories and spare parts.

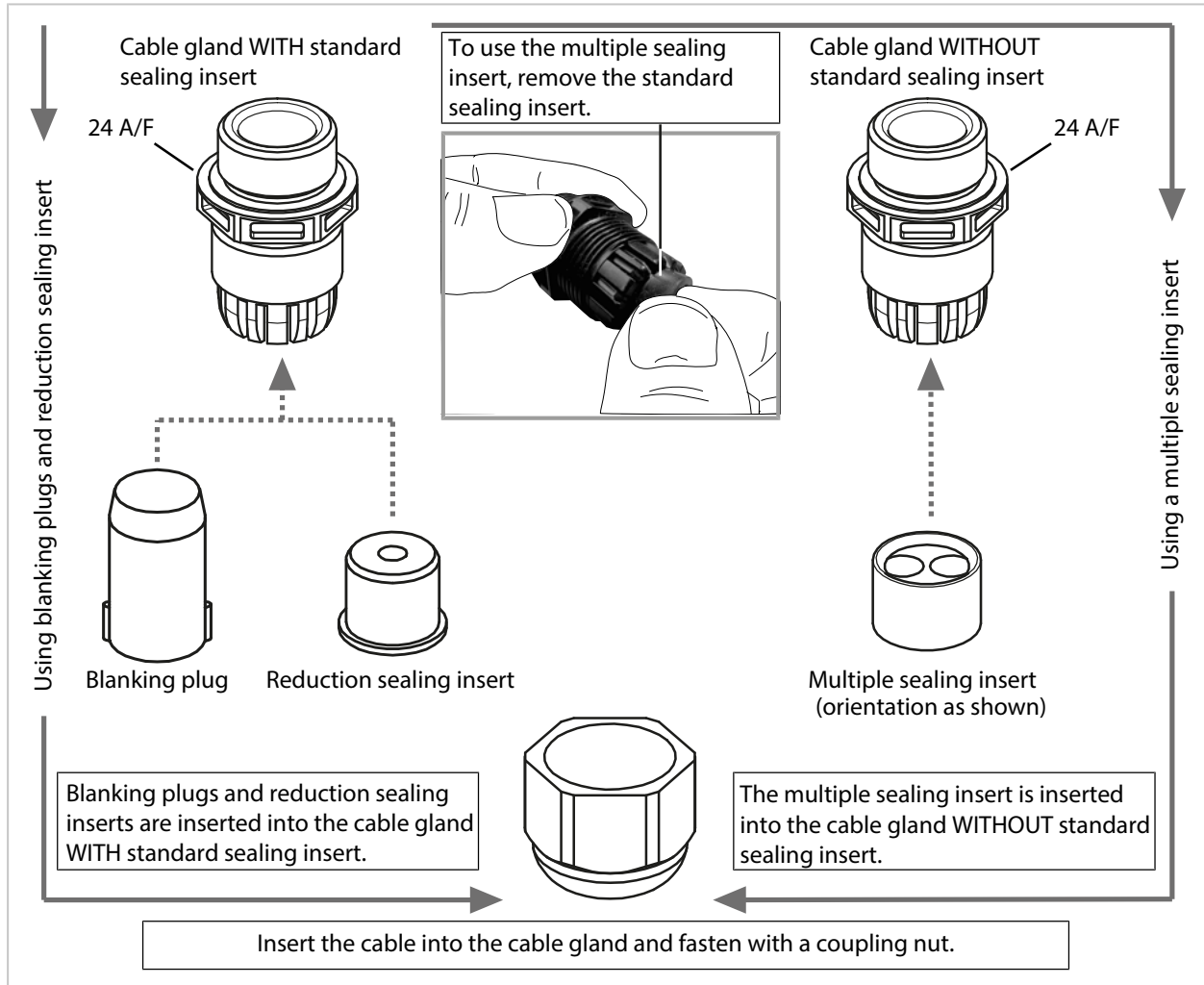

3.5 Connections

Rear of front unit

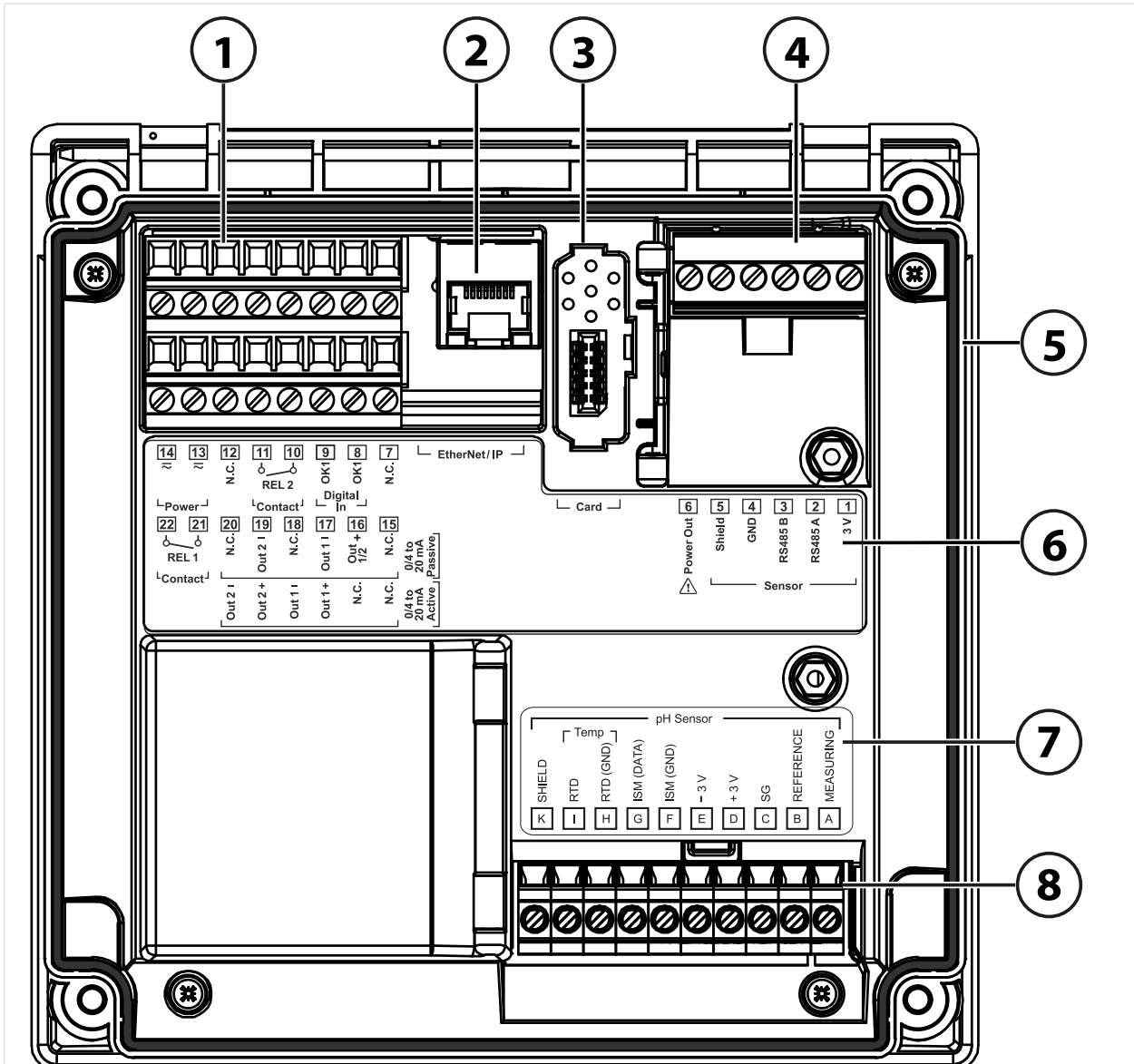

- | | |
|---|--|
| <ul style="list-style-type: none"> 1 Terminals for inputs, outputs, relay contacts, power supply 2 RJ45 socket for EtherNet/IP 3 Slot for memory card (ZU1080-S-*.*) 4 RS-485 interface: Connection for Memosens/ optical sensors (SE740) | <ul style="list-style-type: none"> 5 Circumferential seal 6 Terminal plate 7 Module plate sticker, example of pH module 8 Connected measuring module |
|---|--|

3.6 Terminal Assignment

The terminals are suitable for single wires or stranded wires up to 2.5 mm².

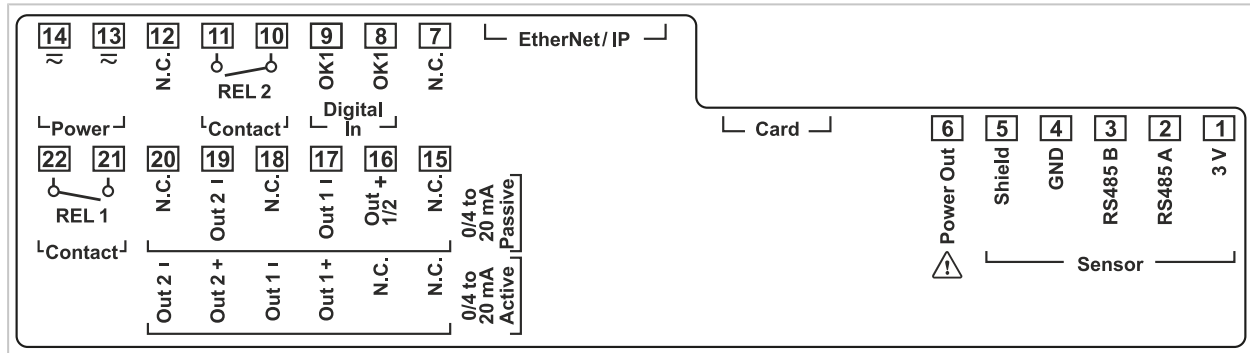

Terminal	Connection		
Sensor (Memosens or other digital sensor)	1	3 V	
	2	RS485 A	
	3	RS485 B	
	4	GND	
	5	Shield	
	6	Power out	Auxiliary power output for supplying power to special sensors or external transmitters
	Card	Memory card	
	EtherNet/IP	RJ45 socket	
	7	N.C., no connection	
Digital control input Optocoupler input	8	OK1	
	9	OK1	
Relay contact REL 2	10	Relay 2	Contact rating → <i>Specifications, p. 205</i>
	11	Relay 2	
	12	N.C., no connection	
Power supply 24 V ... 230 V AC/DC	13	Power	Power supply input
	14	Power	
Current outputs Out 1/2 (0)4 mA ... 20 mA		Active	Passive
	15	N.C., no connection	N.C., no connection
	16	N.C., no connection	+ Out 1/2
	17	+ Out 1	- Out 1
	18	- Out 1	N.C., no connection
	19	+ Out 2	- Out 2
	20	- Out 2	N.C., no connection
	Relay contact REL 1	21	Relay 1
22		Relay 1	

See also

→ *Power Supply (Power), p. 205*

3.7 Electrical Installation

⚠ WARNING! The device does not have a power switch. An appropriately arranged and accessible disconnecting device for the transmitter must be present in the system installation. The disconnecting device must disconnect all non-grounded, current-carrying wires and be labeled such that the associated transmitter can be identified.

⚠ WARNING! The power cord may carry voltages that are dangerous to touch. Only install the product in a voltage-free state. Secure the system against accidental restart.

NOTICE! Strip the insulation from the wires using a suitable tool to prevent damage. Stripping length max. 7 mm.

NOTICE! Damage to the screw terminals due to excessive tightening torque. Tighten the screw terminals with a maximum torque of 0.6 Nm.

01. Before commencing with the installation, make sure that all lines to be connected are de-energized.
02. Wire the connections.
 - *RJ45 Ethernet Socket Wiring, p. 27*
 - *Installing Active and Passive Current Outputs, p. 28*
 - *Relay Contacts: Protective Wiring, p. 28*
03. Deactivate unused current outputs in the parameter settings or use insertable jumpers.
 - *Current Outputs, p. 55*
04. Connect the power supply cables.
05. When measuring with analog sensors or a second Memosens sensor: Insert the measuring module into the module slot. → *Connecting an Analog Sensor/Second Memosens Channel, p. 31*
06. Connect the sensor(s). → *Sensor Connection, p. 30*
07. Check whether all connections are correctly wired.
08. Open the front unit and tighten the enclosure screws in diagonal sequence with a Phillips head screwdriver. Tightening torque 0.5 ... 2 Nm
09. Before switching on the power supply, make sure its voltage is within the specified range (values → *Specifications, p. 205*).
10. Switch on the power supply.

3.7.1 RJ45 Ethernet Socket Wiring

Pin	Name	Description
1	TD+	Transmitted data +
2	TD-	Transmitted data -
3	RD+	Received data +
6	RD-	Received data -

3.7.2 Installing Active and Passive Current Outputs

The current outputs directly supply current (0/4 ... 20 mA) to a load according to the selected process variable.

Passive current outputs require an external supply voltage.

Note: Observe the specifications and connected loads. → *Specifications, p. 205*

Terminal Assignment Diagram

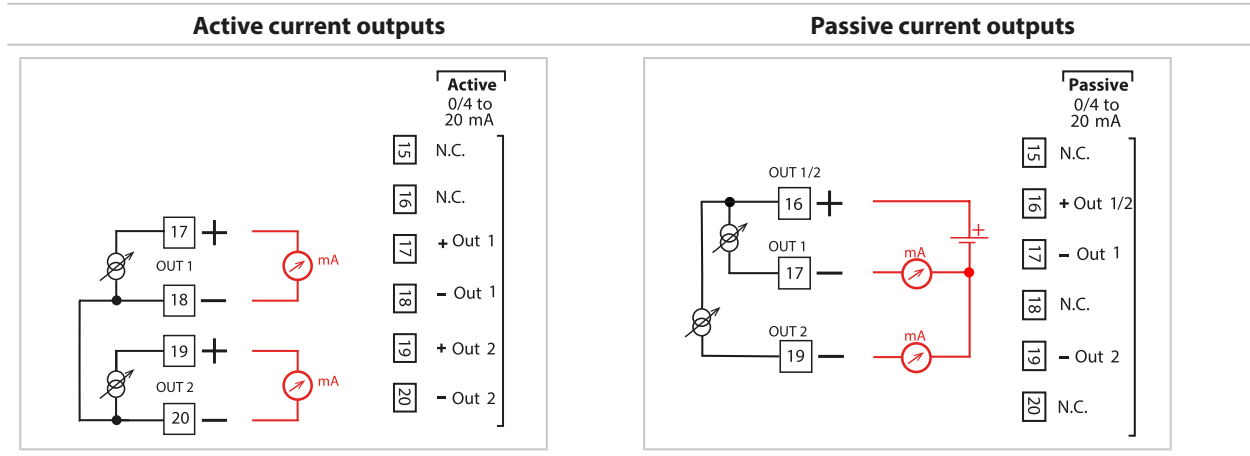

3.7.3 Relay Contacts: Protective Wiring

Relay contacts are subject to electrical erosion. With inductive and capacitive loads in particular, this will reduce the service life of the contacts. For suppressing sparks and arcing, use components such as RC combinations, non-linear resistors, series resistors, and diodes.

NOTICE! The permissible load capability of the relay contact must not be exceeded, even during switching operations. → *Specifications, p. 205*

Note on Relay Contacts

As delivered, the relay contacts are suitable for low signal currents (as of approx. 1 mA). If currents above approx. 100 mA are switched, the gold plating is destroyed during the switching process. After that, the contacts will not reliably switch low currents.

Parameter setting for relay contacts → *Relay Contacts, p. 58*

Wiring of relay contacts → *Terminal Assignment, p. 26*

Typical AC Application with Inductive Load

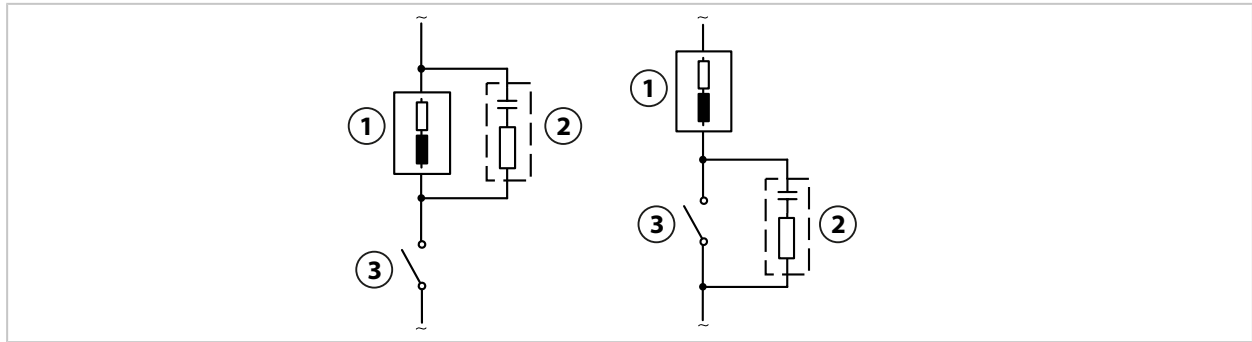

- | | |
|---|-----------|
| 1 Load | 3 Contact |
| 2 Typical RC combination, e.g., capacitor 0.1 μ F, resistance 100 Ω /1 W | |

Typical DC Application with Inductive Load

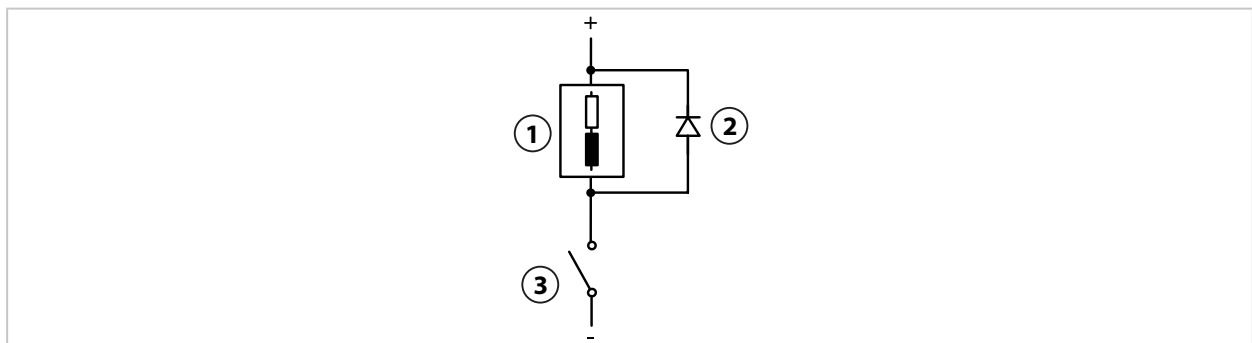

- | | |
|---|-----------|
| 1 Inductive load | 3 Contact |
| 2 Free-wheeling diode, e.g., 1N4007 (note polarity) | |

Typical AC/DC Application with Capacitive Load

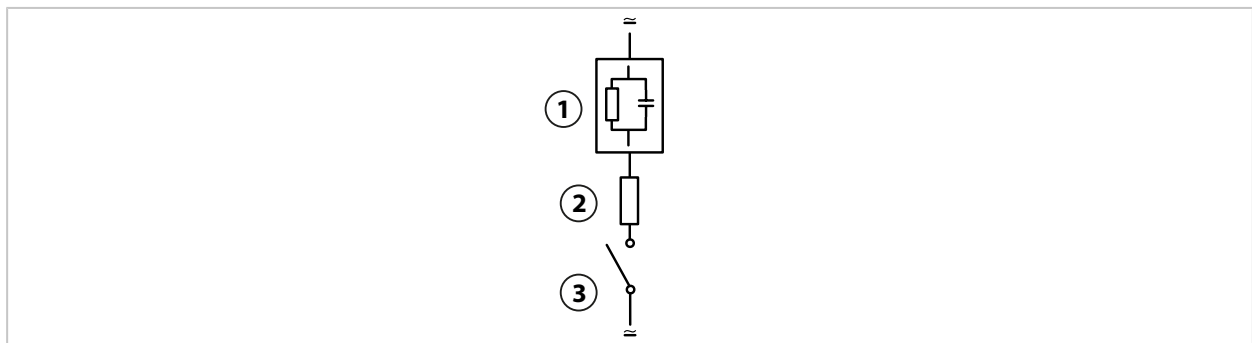

- | | |
|--|-----------|
| 1 Capacitive load | 3 Contact |
| 2 Resistance e.g., 8 Ω /1 W at 24 V/0.3 A | |

3.8 Sensor Connection

3.8.1 Connecting a Memosens Sensor/Optical Oxygen Sensor (LDO)

Top view of terminals for Memosens/LDO sensor. The figure shows the opened device, rear side of the front unit.

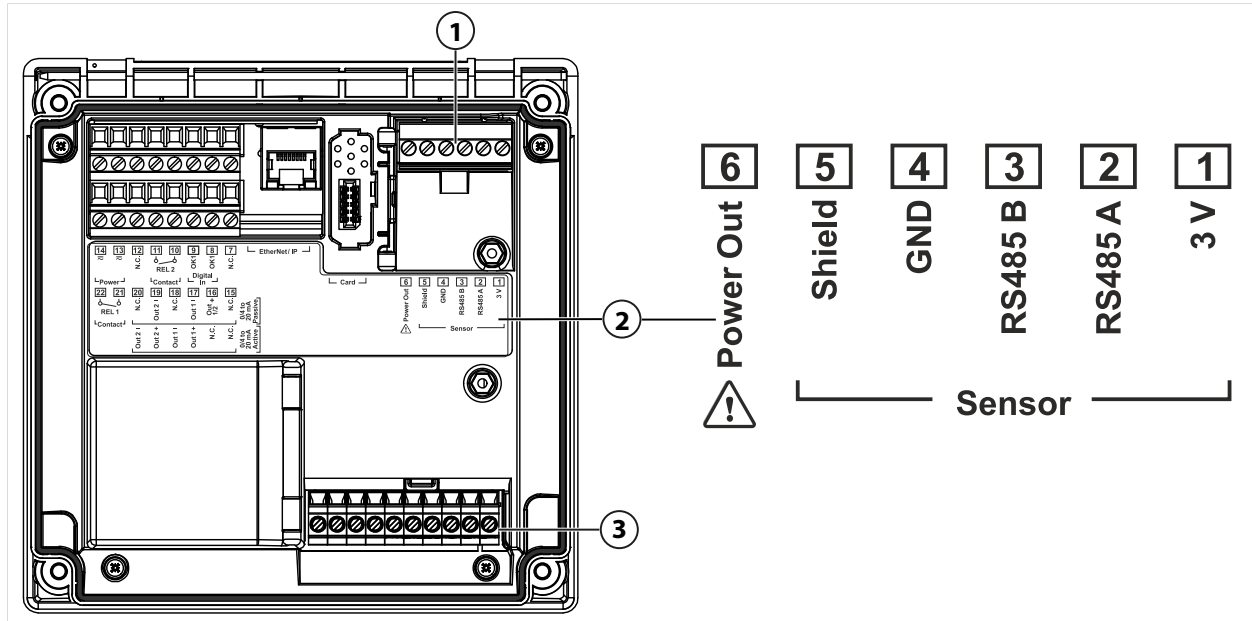

- 1 RS-485 interface: Standard sensor connection for digital sensors (Memosens sensor/LDO SE740 sensor)
- 2 Terminal plate with terminal assignments for digital sensor
- 3 Sensor connection for analog sensors or second Memosens sensor via measuring module

Memosens sensor			SE 740 optical oxygen sensor (LDO)		
Terminal	Wire color	Memosens cable wiring	Terminal	Wire color	M12 cable wiring
1	Brown	+3 V	1	-	
2	Green	RS-485 A	2	Gray	RS-485 A
3	Yellow	RS-485 B	3	Pink	RS-485 B
4	White	GND	4	Brown	GND
5	Transparent	Shield	5	-	-
6			6	White	Power out

01. Using an appropriate sensor cable, connect a Memosens sensor or the SE740 optical oxygen sensor (LDO) to the RS-485 interface (1) of the Stratos Multi.
02. Close the device and tighten the screws on the front.
03. Next, select the measurement method and set the sensor parameters:
From the measuring mode, press the **left softkey: Menu**.
✓ **Menu Selection** opens.
04. Select **Parameter Setting** ▶ **Sensor Selection [I] [II]**.
Note: Function check (HOLD) is active.
05. Press **enter** to open **Sensor Selection [1]**.
06. Select the process variable, mode, and functionality, and confirm with **enter**.
Set further parameters with the **left softkey: Back**.
07. To end the configuration go back to measuring mode, e.g., with the **right softkey: Back to Meas.**

3.8.2 Connecting an Analog Sensor/Second Memosens Channel

⚠ CAUTION! Electrostatic discharge (ESD). The modules' signal inputs are sensitive to electrostatic discharge. Take measures to protect against ESD before inserting the module and connecting the inputs.

Measuring Modules for Connecting Analog Sensors: pH, ORP, Oxygen, Conductivity

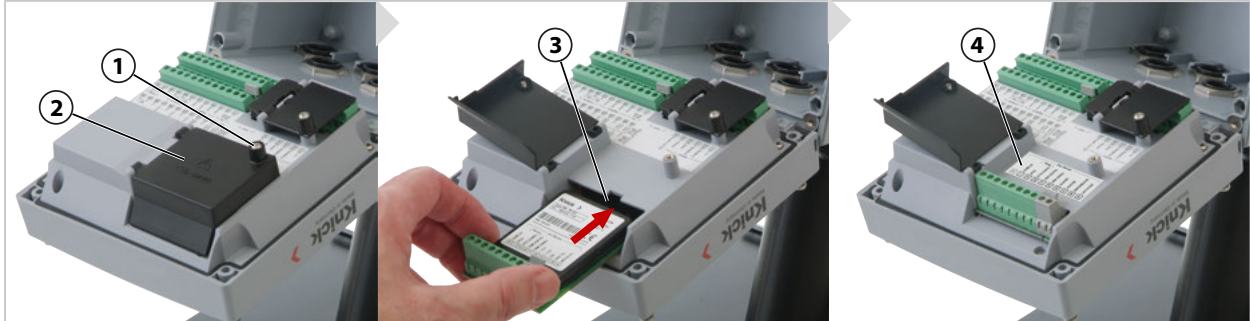

01. Switch off the power supply of the device.
02. Open the device (loosen the 4 screws on the front).
03. Loosen the screw **(1)** on the module cover **(2)** ("ESD shield") and open the flap.
04. Insert the module into the module slot **(3)**.
05. Attach the module plate sticker **(4)**.
06. Strip the wires with a suitable tool. Stripping length 7 mm
07. Connect the sensor and, if required, the separate temperature detector.
→ *Channel II Wiring Examples, p. 218*
08. Check whether all connections are correctly connected.
09. Close the module cover **(2)** and tighten the screw **(1)**.
10. Close the device and tighten the screws on the front. Tightening torque 0.5 ... 2 Nm
11. Switch on the power supply.

Selecting a Measurement Method and Setting the Sensor Parameters

01. From the measuring mode, press the **left softkey: Menu**.
✓ **Menu Selection** opens.
02. Select **Parameter Setting** ▶ **Sensor Selection [I] [II]**.

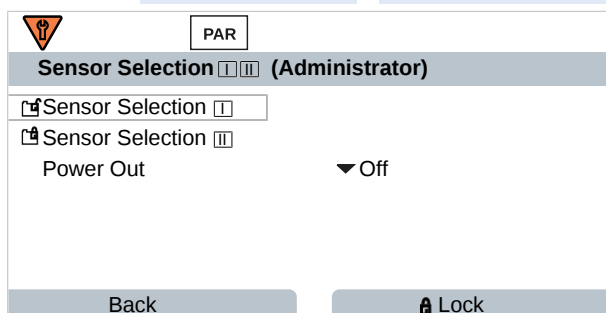

Note: Function check (HOLD) is active.

03. Press **enter** to open **Sensor Selection [II]**.
04. Select the module and mode, and confirm with **enter**.
Set further parameters with the **left softkey: Back**.
05. To end the configuration go back to measuring mode, e.g., with the **right softkey: Back to Meas**.

Measuring Module for Connecting a Second Memosens Sensor

If you want to measure two process variables using Memosens sensors, you must insert an MK-MS095N Memosens module for the second channel.

01. Insert a Memosens module into the module slot and connect it (see above).
02. Next, select the measurement method and set the sensor parameters:
From the measuring mode, press the **left softkey: Menu**.
✓ **Menu Selection** opens.
03. Select **Parameter Setting** ▶ **Sensor Selection [I] [II]** .
Note: Function check (HOLD) is active.
04. Press **enter** to open **Sensor Selection [II]** .
05. Select module MK-MS.
06. Select the process variable, mode, and functionality, and confirm with **enter**.
Set further parameters with the **left softkey: Back**.
07. To end the configuration go back to measuring mode,
e.g., with the **right softkey: Back to Meas.**

3.9 Terminal Assignments of Measuring Modules

Installation of the measuring modules

→ *Connecting an Analog Sensor/Second Memosens Channel, p. 31*

For the terminal assignments of the connected measuring module, see the module plate sticker (1) under the module cover on the rear of the front unit.

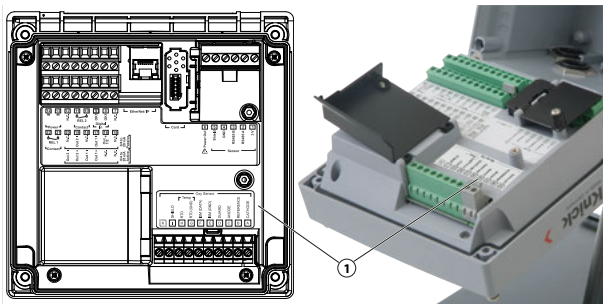

pH/ORP Measuring Module

Order No. MK-PH015N

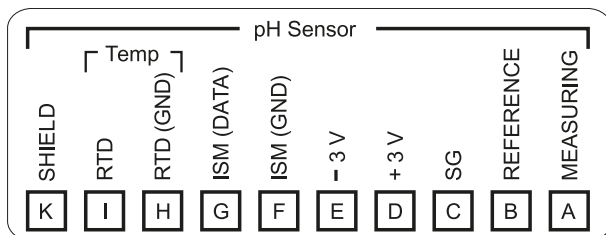

Oxygen Measuring Module

Order No. MK-OXY046N

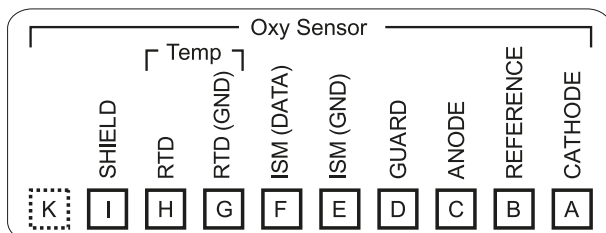

Module for Contacting Conductivity Measurement

Order No. MK-COND025N

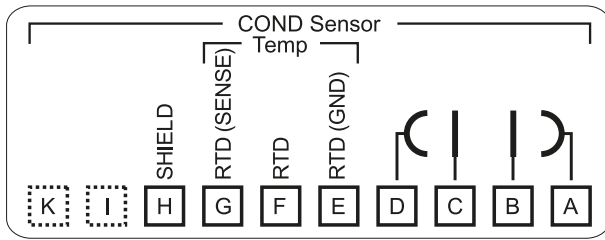

Module for Inductive Conductivity Measurement

Order No. MK-CONDI035N

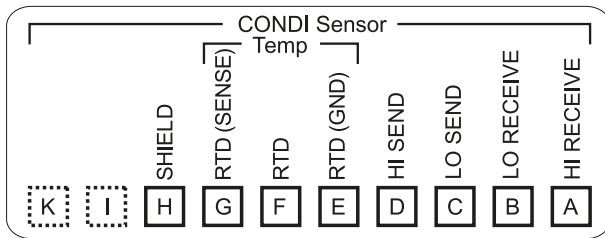

Module for Dual Conductivity Measurement

Order No. MK-CC065N

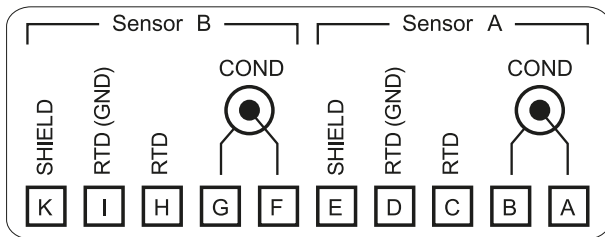

Memosens Module

Order No. MK-MS095N

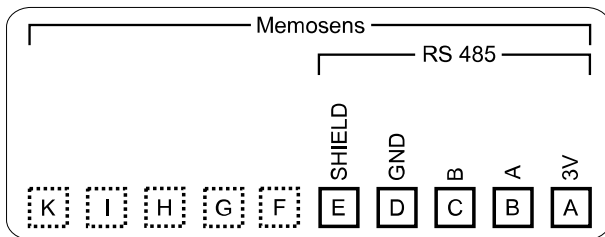

4 Commissioning

Note: Upon request, Knick will provide safety briefings and product training during initial commissioning of the product. More information is available from the relevant local contacts.

01. Install the enclosure. → *Installation, p. 17*
02. Wire the connections. → *Electrical Installation, p. 27*
03. Connect the sensor(s). → *Sensor Connection, p. 30*
04. Set the device parameters. → *Parameter Setting, p. 40*
05. Configure the EIP channel. → *EtherNet/IP, p. 102*

4.1 Final Check During Commissioning

- Are the Stratos Multi and all its cables externally intact and strain-relieved?
- Are the cables routed without loops or crossovers?
- Have all the wires been correctly connected in accordance with their terminal assignments?
- Was the tightening torque of the screw terminals correctly adhered to?
- Are all connectors firmly engaged?
- Are all cable glands installed, tight, and leak-proof?
- Is the device closed and correctly screwed together?
- Does the supply voltage (power supply) accord with the voltage indicated on the nameplate?

5 Operation and Use

5.1 Changing the User Interface Language

Requirements

- Stratos Multi is connected to the power supply.
- Measuring mode is shown on the display.

Steps

01. **Left softkey: Menu.** The Menu Selection opens.
02. Press **right softkey: Lingua.** Press the right **arrow key** and set the language of the user interface.
03. Confirm with **enter**.

Note: The user interface language can also be changed in the Parameter Setting menu.

Parameter Setting ▶ General ▶ Language → *Parameter Setting, General, p. 48*

5.2 Display and Keypad

Display

Stratos Multi features a 4.3" TFT color graphic display. The Calibration, Maintenance, Parameter Setting, and Diagnostics menus each have their own color. The device is operated with plain text in different languages. Messages are output as icons and plain text.

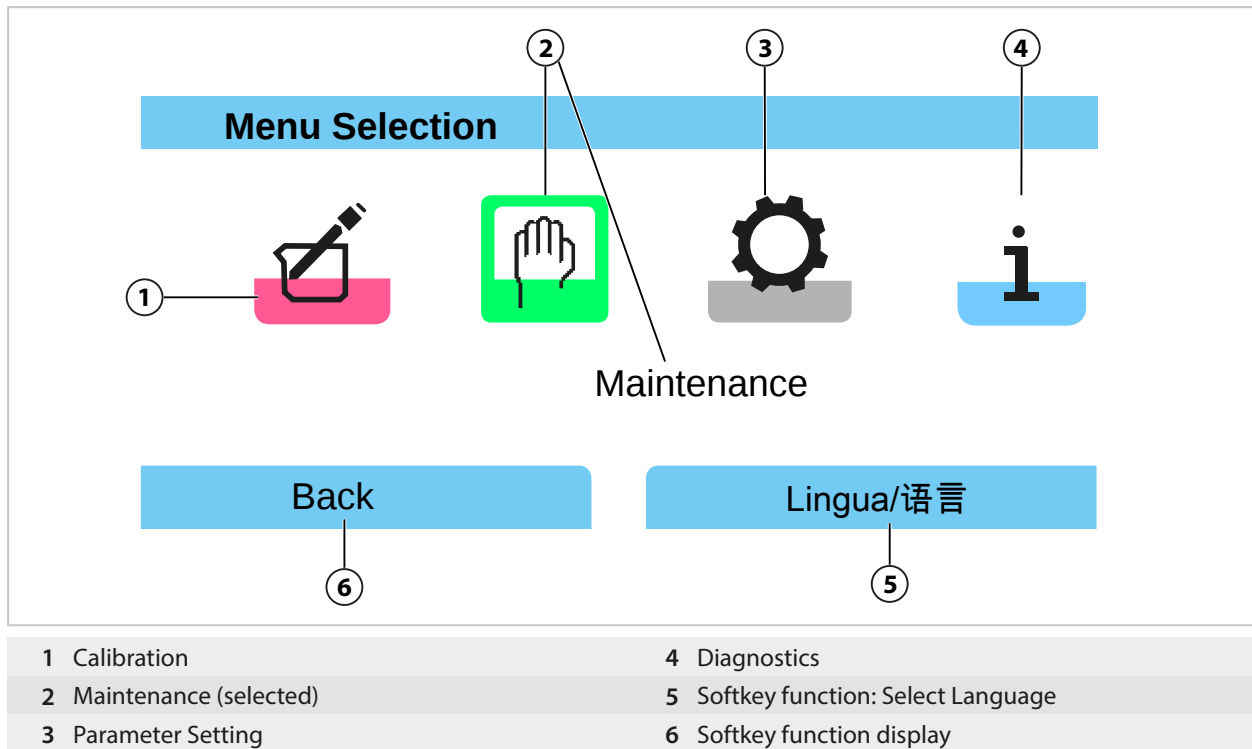

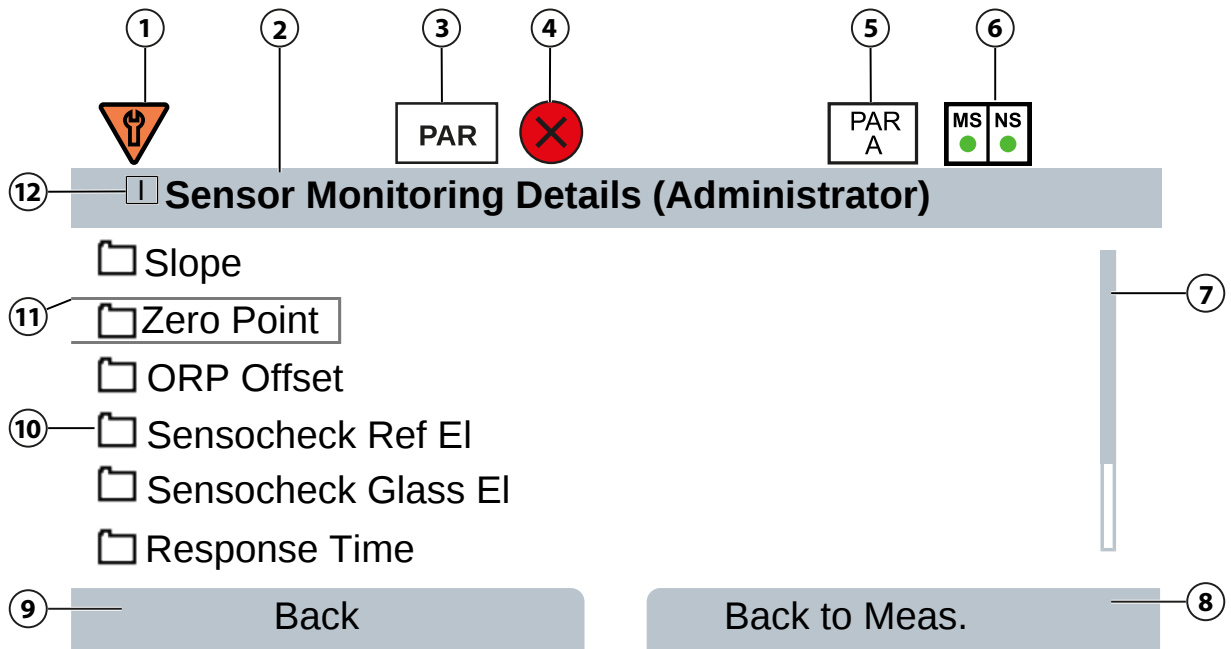

1	Function check (HOLD)	7	Scrollbar
2	Current menu heading	8	Softkey function display
3	Device condition (PAR for parameter setting)	9	Softkey function display
4	Failure is active	10	Folder element
5	Active parameter set	11	Selected element
6	Display of module and network status	12	Measuring channel, e.g., channel I

Display of Measuring Channels

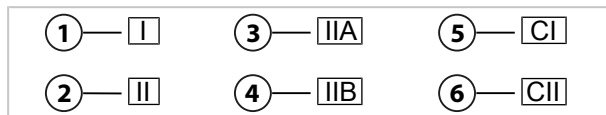

1	Channel I	4	Second channel in MK-CC module
2	Channel II (measuring module)	5	Calculation block 1
3	First channel in MK-CC module	6	Calculation block 2

Overview of icons → *Symbols and Markings on the Display, p. 241*

Keypad

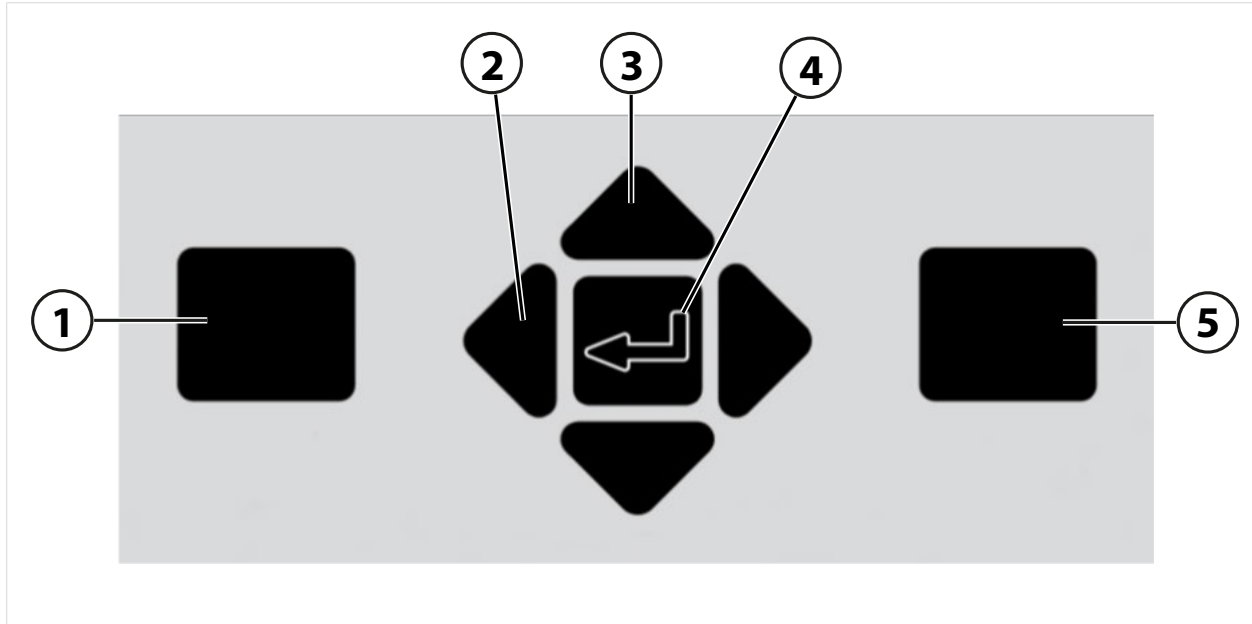

- | | |
|---|--|
| <p>1 Left softkey:
Function in accordance with the left function display</p> <p>2 Left/right arrow keys:
Menu selection: previous/next menu, digit selection to the left/right</p> <p>3 Up/down arrow keys:
Row selection from selection window, increase/decrease a numeric value</p> | <p>4 Enter:
Open menu, confirm entries.</p> <p>5 Right softkey:
Function in accordance with the right function display</p> |
|---|--|

Entering Text and Numbers; Selecting Signs

01. Select a number with the *Left/right arrow keys*.
 02. Enter numbers or letters with the *Up/down arrow keys*.
- Change sign if required:
03. Switch to signs with the left *arrow key*.
 04. Set the sign value with the *up or down arrow keys*.
 05. Confirm with *enter*.

Note: If you enter values outside the specified value range, an information window showing the permissible value range is shown.

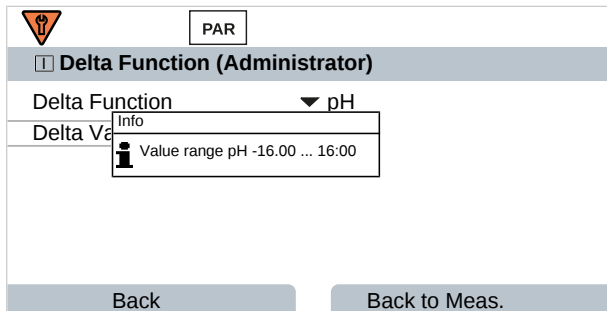

5.3 Menu Structure Overview

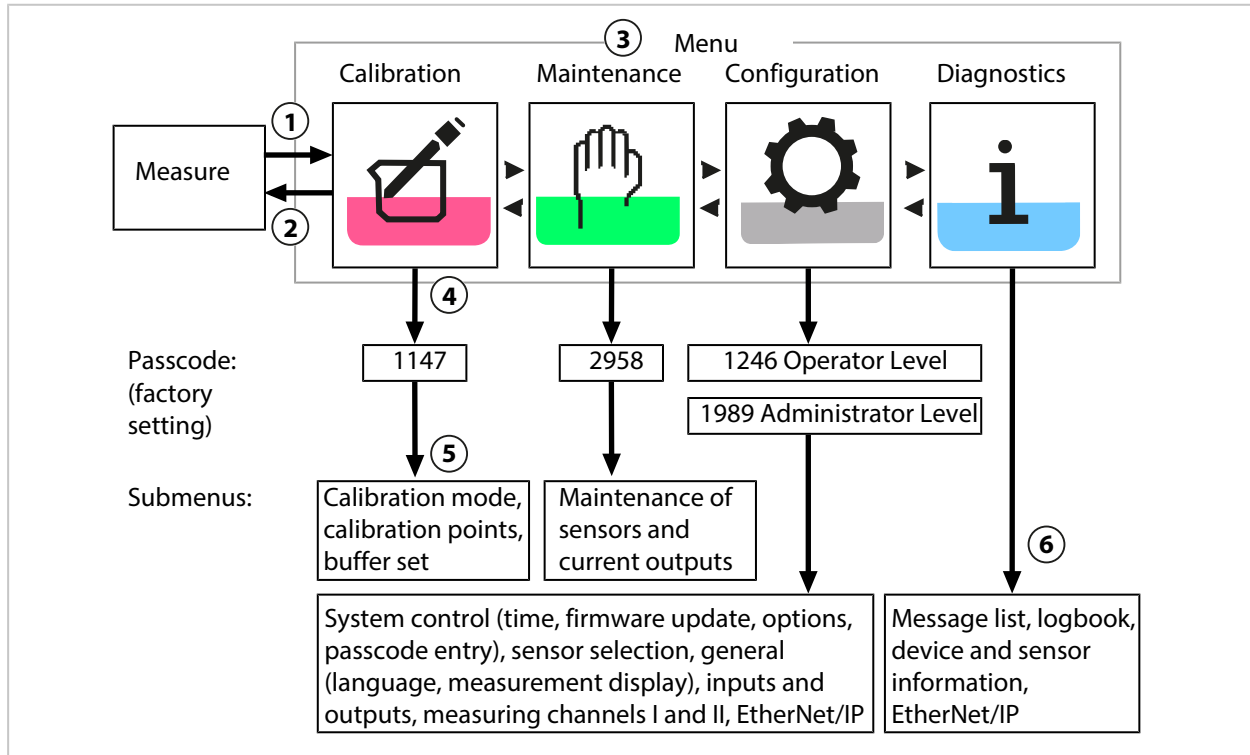

- | | |
|--|---|
| <p>1 Left softkey: Menu accesses the Menu Selection.</p> <p>2 Right softkey: Back to Meas. returns to measurement.</p> <p>3 Select a menu using the arrow keys.</p> | <p>4 Press enter to confirm, enter passcode.</p> <p>5 Further submenus and menu items are shown.</p> <p>6 Selected functions in the Diagnostics menu can also be accessed in measuring mode by pressing the right softkey (Favorites menu).</p> |
|--|---|

5.4 Access Control

Access to the device functions is regulated and limited by individually adjustable passcodes. This prevents the unauthorized modification of device settings or manipulation of the measurement results.



















Set passcodes under **Parameter Setting** ▶ **System Control** ▶ **Passcode Entry** → *Passcode Entry, p. 48*

5.5 Operating States

Function Check Mode (HOLD Function)

After activating parameter setting, calibration, or maintenance, the Stratos Multi enters function check mode (HOLD). EtherNet/IP communication and the relay contacts/current outputs behave in accordance with the parameter settings. The state transmitted via EtherNet/IP is in part dependent on the operating mode.

⚠ CAUTION! In function check mode (HOLD), the current outputs may be frozen at the last measured value or set to a fixed value. Measurement operations must not be carried out while the device is in function check mode (HOLD), as the system may behave unexpectedly and put users at risk.

Operating mode	Current Outputs	Contacts ¹⁾	Timeout ²⁾
Measure			-
Diagnostics			-
Calibration ³⁾			-
Maintenance ³⁾			
Sensor monitor			-
Current source			-
Parameter setting ³⁾			20 min
Rinse function ³⁾		 ⁴⁾	At end of rinse time
 Active (output functions normally)	 Manual control of the outputs		
 Last value or fixed default value	 Depending on parameter setting		

5.6 Measurement Display

The following settings are possible:

2, 4, 6, or 8 values without measuring channel selection	Any display of measured values from the measuring channels and the device possible
2 or 4 values with measuring channel selection	Any display of measured values from the measuring channels

Settings are made in the **Measurement Display** submenu:

Parameter Setting ▶ **General** ▶ **Measurement Display**

An overview of display options can be found in the **Parameter Setting** chapter.

→ *Parameter Setting, General, p. 48*

The **right softkey: Back to Meas.** returns you to measurements from any menu level. You may have to confirm that the system is ready for measurement.

If required, the display can be configured to switch off after not having been used for a user-defined period of time.

This setting can be changed in the **Display** submenu:

Parameter Setting ▶ **General** ▶ **Display**

Display shutdown can be configured as follows:

- No shutdown
- After 5 minutes
- After 30 minutes

¹⁾ The relay contacts are only available in EtherNet/IP mode. Analog current outputs and relay contacts cannot be used at the same time.

²⁾ "Timeout" means that the device will return to measuring mode after 20 minutes without key activity.

³⁾ Function check (HOLD) is active.

⁴⁾ Rinse contact is active.

6 Parameter Setting

⚠ CAUTION! Faulty parameter settings or adjustments can result in faulty outputs. A system specialist must therefore commission Stratos Multi, set all its parameters, make all necessary adjustments, and protect it from unauthorized modifications.

Note: Ethernet configuration → *EtherNet/IP, p. 102*

Opening Parameter Setting

Left softkey: Menu Menu Selection ▶ Parameter Setting

01. From the measuring mode, press the **left softkey: Menu**.

✓ The **Menu Selection** opens.

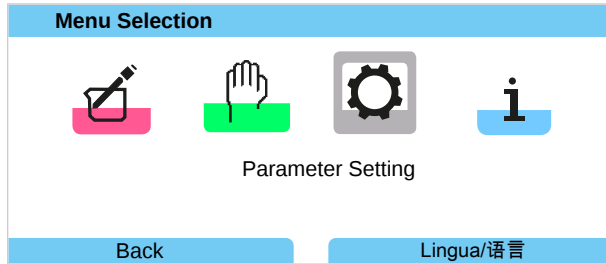

02. Using the right **arrow key**, select the **Parameter Setting** menu and confirm with **enter**.

03. Select the relevant operating level and enter any required passcode.

✓ The Parameter Setting menu contains items for things such as inputs and outputs, sensor selection I and II, system control, and general parameter setting. Parameter setting is automatically ended 20 minutes after the last registered keystroke, after which Stratos Multi returns to measuring mode (timeout).

Note: Function check (HOLD) is active. EtherNet/IP communication and the relay contacts or the current outputs behave in accordance with the parameter settings. Return to measuring mode to exit the function check, e.g., with the **right softkey: Back to Meas**.

6.1 Operating Levels

There are three access levels in the Parameter Setting menu:

- Viewing Level (all data)
- Operator Level (operational data)
- Administrator Level (all data)

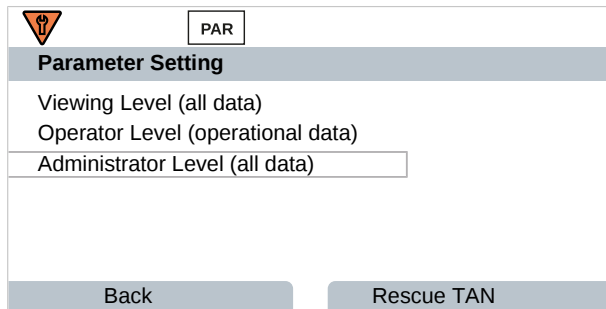

Viewing Level

- Display of all settings
- Settings cannot be changed on the viewing level.

Operator Level

- Access to all functions that are enabled on the Administrator level.
- Locked functions are displayed in gray and cannot be edited.

Administrator Level

- Access to all settings, including passcode settings. → *Passcode Entry, p. 48*
- Releasing or locking functions for access from the operator level. Functions that can be locked for the operator level are marked with the “lock” icon. → *Locking a Function, p. 41*

Note: For reasons of clarity, the step to “Select the relevant operating level and enter any required passcode” is omitted in the parameter setting description set out in this document. Parameter setting is generally carried out at Administrator level.

6.2 Locking a Function

Example: Locking access to the setting options for relay contact K1 from the operator level

01. Open **Parameter Setting**.
02. Select **Administrator Level**.
03. Enter passcode (factory setting 1989).
04. Select submenu:
Inputs/Outputs ▶ Relay Contacts ▶ Contact K1

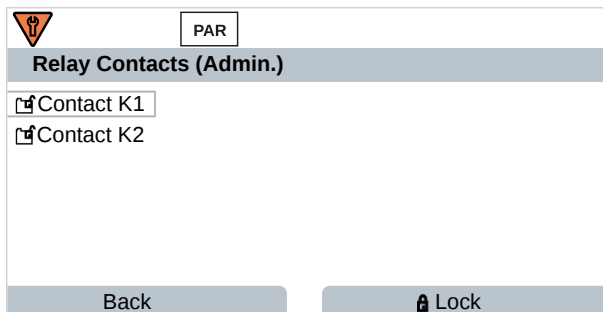

05. **Right softkey: Lock**
 - ✓ The **Contact K1** submenu is now marked with the “lock” icon. This function can no longer be accessed from the operator level.
The **Softkey** function automatically changes to **Unlock**.
 - ✓ On the operator level, the locked function is shown in gray.

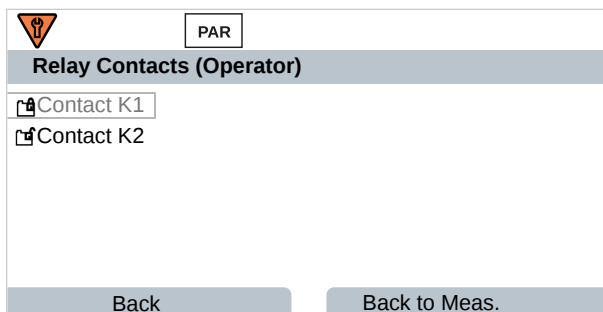

6.3 Parameter Setting Menus

Menu	Description
System Control	→ <i>System Control</i> , p. 42
General	→ <i>Parameter Setting, General</i> , p. 48
Inputs/Outputs	→ <i>Inputs/Outputs</i> , p. 55
Sensor Selection [I] [II]	→ <i>Sensor Selection [I] [II]</i> , p. 63
[I] [Sensor]	Channel I parameter settings: Menu depends on sensor selection.
[II] [Sensor]	Channel II parameter settings: Menu depends on sensor selection.
EtherNet/IP	→ <i>EtherNet/IP</i> , p. 102

6.4 System Control

Submenu	Description
Memory Card	This menu item is shown if a Data Card is inserted: Settings for logbook and measurement recorder data recording. The memory card can be formatted. → <i>Memory Card</i> , p. 43
Transfer Configuration	When a Data Card is inserted, the transmitter configuration can be saved and transferred to another transmitter. → <i>Transfer Configuration</i> , p. 43
Parameter Sets	Two parameter sets (A, B) are available in the device. If a Data Card is inserted, up to five parameter sets can be saved on or loaded from the Data Card. → <i>Parameter Sets</i> , p. 44
Function Control	Allocate functions for activation via softkey or optocoupler input OK1. → <i>Function Control</i> , p. 45
Calculation Blocks	TAN option FW-E020: Calculate existing process variables to new variables. → <i>Calculation Blocks (FW-E020)</i> , p. 194
Time/Date	Define date and time format; entry of date, time, and weekday. → <i>Time/Date</i> , p. 46
Meas. Point Description	Free entry of a tag number and annotations; can be opened in the Diagnostics menu. → <i>Measuring Point Description</i> , p. 46
Firmware Update	This menu item is shown if an FW update card is inserted. TAN option FW-E106: Firmware update with FW update card. → <i>Firmware Update (FW-E106)</i> , p. 204
Option Activation	Activation of add-on options via TAN. The TAN is only valid for the Stratos Multi with the associated serial number. → <i>Option Activation</i> , p. 47
Logbook	Select events to be logged (Failure/Maintenance Required); can be opened in the Diagnostics menu. → <i>Logbook</i> , p. 47
Buffer Table	TAN option FW-E002: Define a buffer set. → <i>pH Buffer Table: Entry of Individual Buffer Set (FW-E002)</i> , p. 186
Concentration Table	TAN option FW-E009: Define a special concentration solution for conductivity measurement. → <i>Concentration Determination (FW-E009)</i> , p. 187
Restore Factory Settings	Reset all parameter settings to factory settings. → <i>Restore Factory Settings</i> , p. 48
Passcode Entry	Change passcodes. → <i>Passcode Entry</i> , p. 48

6.4.1 Memory Card

This menu is displayed when the ZU1080-S-*-D Data Card is inserted.

With activated TAN option FW-E104 Logbook: Switch recording of logbook entries on the Data Card on/off. → *Logbook (FW-E104), p. 203*

With activated TAN option FW-E103 Measurement recorder: Enable/disable recording of measurement recorder on the Data Card. → *Measurement Recorder (FW-E103), p. 201*

The decimal separator can be set as a point or comma.

The Data Card can be formatted, in which case all saved entries are deleted.

See also

→ *Memory Card, p. 181*

6.4.2 Transfer Configuration

All device settings can be saved on a memory card (ZU1080-S-*-D Data Card): → *Memory Card, p. 181*

Parameter Setting ▶ System Control ▶ Transfer Configuration

Note: The inserted Data Card is shown on the display.

- With "Configuration" selection: Select "Save" to write all the device settings (except passcodes) to the Data Card. Backup file generated on the Data Card: param/config.par
- With "Configuration" selection: Select "Load" to read all the device settings from the Data Card and apply them to the device.

Transferring all Device Settings from One Device to Other Devices

Requirements

- The devices all feature identical hardware.
- TAN options (add-on functions):
All required TAN options must be enabled before they can be transferred.

Steps

01. Parameter Setting ▶ System Control ▶ Transfer Configuration
02. "Configuration" menu item: "Save"
03. Press **right softkey: Execute** to start the transmission.
✓ The device settings are saved to the Data Card.
04. Open/Close Memory Card submenu
05. Press **right softkey: Close** to end the access to the memory card.
06. Remove the Data Card.
✓ You can transfer the device settings to other, identically equipped devices.
07. Insert the data card upon which the device settings are saved into the next device to be configured.
08. Parameter Setting ▶ System Control ▶ Transfer Configuration
09. "Configuration" menu item: "Load"
10. Press **right softkey: Execute** to start the transmission.
✓ The device settings are read from the Data Card and applied.
11. Open/Close Memory Card submenu
12. Press **right softkey: Close** to end the access to the memory card.
13. Remove the Data Card.

6.4.3 Parameter Sets

Stratos Multi provides two complete selectable parameter sets (A/B) for different measurement tasks. The currently activated set can be signaled by a relay contact. → *Relay Contacts, p. 58*

Parameter set "B" only permits setting of process-related parameters.

Parameter Setting ▶ System Control ▶ Parameter Sets

Save Parameter Set

The active parameter set is transferred to the Data Card.

Note: The parameter set saved on the Data Card is overwritten.

Load Parameter Set

A parameter set stored on the Data Card is transferred to the device.

Note: This overwrites the current parameter set in the device.

Up to 5 parameter sets can be stored on the Data Card with TAN option FW-E102.

→ *Parameter Sets 1-5 (FW-E102), p. 199*

Select Parameter Set A/B

Note: Switching parameter sets only works locally on the device, not via Ethernet.

The control element for selecting the parameter set (optocoupler input OK1 or softkey) is selected under:

Parameter Setting ▶ System Control ▶ Function Control

The currently active parameter set is shown in the status line by an icon:



Selection via a signal at optocoupler input OK1:

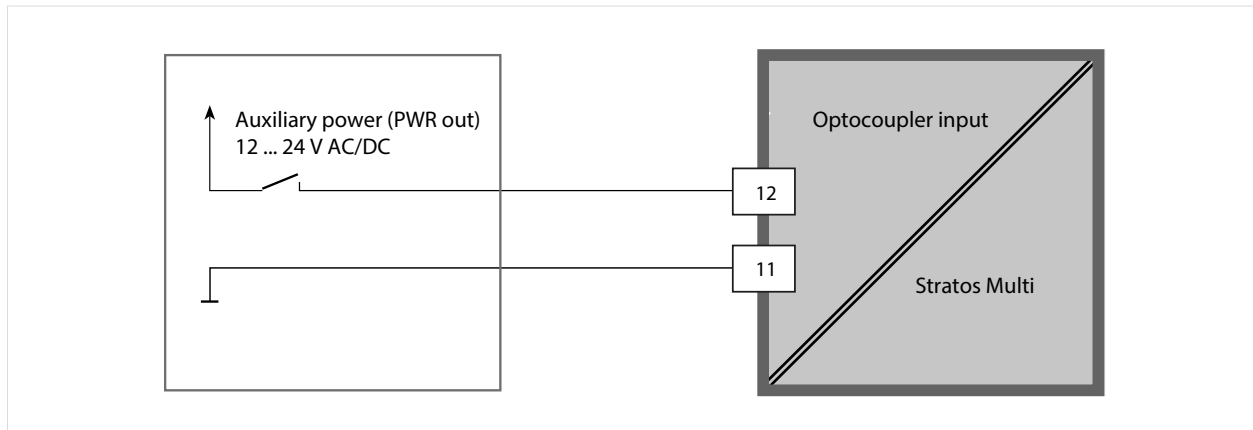

0 ... 2 V AC/DC: Parameter Set A active

10 ... 30 V AC/DC: Parameter Set B Active

Note: The selection has no effect when using parameter sets from a memory card. Switching between parameter sets A and B is possible if they are saved in the device.

6.4.4 Function Control

The following functions can be activated by softkey or optocoupler input OK1:

Input OK1:

- Parameter set selection → *Parameter Sets, p. 44*
- Flow → *Flow, p. 111*
- Function check
- Function check (channel)

Right softkey:

- Off
- Value rotation
- Parameter set selection
- Favorites menu

The selection is made in the **Function Control** submenu:

Parameter Setting ▶ System Control ▶ Function Control

Favorites Menu

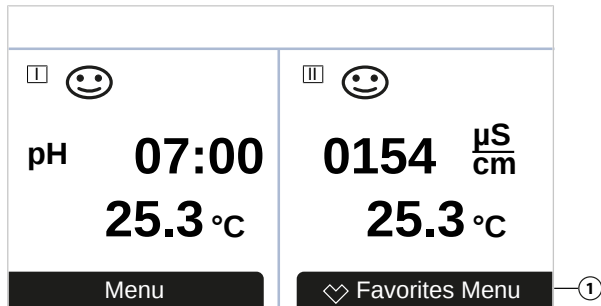

If "Favorites Menu" was assigned to the right softkey, certain menu items in the Diagnostics menu can be specified as "Favorites".

Setting a favorite:

01. Select the desired submenu.

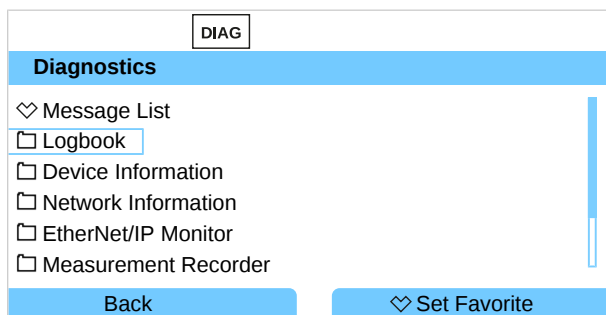

02. **Right softkey: Set Favorite**

- ✓ A heart icon is shown at the front of the menu line. The softkey function changes to **Delete Favorite**.

Deleting a favorite:

03. Open the menu and select the submenu set as a favorite.

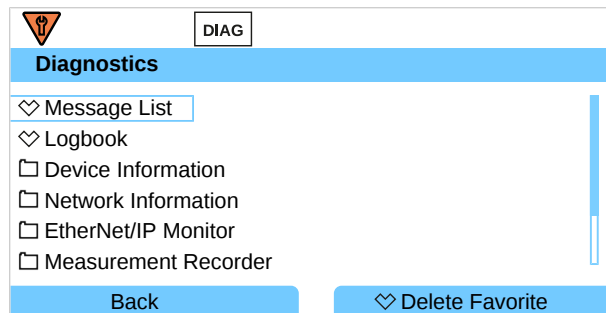

04. *Right softkey: Delete Favorite*

- ✓ The heart icon disappears from in front of the menu line. The softkey function changes to **Set Favorite**.

6.4.5 Calculation Blocks (TAN Option FW-E020)

Calculation blocks convert existing process variables to new variables.

The menu is only shown if the TAN option is activated. → *Calculation Blocks (FW-E020), p. 194*

Parameter Setting ▶ System Control ▶ Calculation Blocks

6.4.6 Time/Date

The time and date in the installed real-time clock are required for:

- Controlling calibration and cleaning cycles
- Displaying the time on the display
- Assigning times to the calibration data in the sensor head of digital sensors
- The diagnostic functions, e.g., time stamp of logbook entries

Note: No automatic switchover from and to daylight savings time.

The settings are made in the **Time/Date** submenu:

Parameter Setting ▶ System Control ▶ Time/Date

6.4.7 Measuring Point Description

You can enter the measuring point and annotations (e.g., date of last maintenance):

- Select points: Left/right arrow keys
- Select characters A-Z 0-9 _ # * + - / : < = > Space: Up/down arrow keys

The settings are made in the **Parameter Setting ▶ System Control ▶ Meas. Point Description** submenu.

If Memosens sensors are used, you can also enter one measuring point description per sensor channel.

The entries are made in the **Sensor Data** submenu of the corresponding Memosens sensor.

Display of the measuring point description in the **Diagnostics** menu

→ *Measuring Point Description, p. 146*

6.4.8 Firmware Update (TAN Option FW-E106)

For a firmware update, the TAN option FW-E106 and a FW update card are required.

→ *Firmware Update (FW-E106), p. 204*

The menu is not shown until the TAN option is activated and the FW update card is inserted.

Parameter Setting ▶ System Control ▶ Firmware Update

6.4.9 Option Activation

Add-on functions (TAN options) expand the functionality of the device system. TAN options are device-related. Therefore, you must specify the serial number of the device in addition to the relevant order no. for this function when ordering a TAN option. The manufacturer then supplies a TAN (transaction number) for activating the add-on function. This TAN is only valid for the device with the associated serial number.

You can find the serial number of your device under:

Diagnostics ▶ Device Information

Overview and description of the individual TAN options → *TAN Options, p. 186*

Activate TAN Option

01. Parameter Setting ▶ System Control ▶ Option Activation

02. Select the option to be enabled.

03. Set to "Active" using the **arrow keys**.

✓ Enter the TAN at the prompt. The current serial number is shown.

04. Enter the TAN and confirm with OK.

✓ The option is available.

Note: An activated TAN option can be deactivated and reactivated without having to re-enter the TAN.

6.4.10 Logbook

The logbook records the last 100 events with date and time, and displays them on the device.

In addition, when using the Data Card and TAN option FW-E104, 20,000 entries or more can be stored on the Data Card. → *Logbook (FW-E104), p. 203*

Parameter Setting ▶ System Control ▶ Logbook

- Select whether to log failure and/or maintenance required messages in the logbook.
- Delete the logbook entries

Display of the Logbook Entries

The entries can be viewed in the **Diagnostics** menu. → *Logbook, p. 145*

Menu Selection ▶ Diagnostics ▶ Logbook

6.4.11 Measurement Recorder (TAN Option FW-E103)

With TAN option FW-E103: Delete the data stored on the measurement recorder.

The menu is only shown if the TAN option is activated.

Parameter Setting ▶ System Control ▶ Measurement Recorder

See also

→ *Measurement Recorder (FW-E103), p. 201*

6.4.12 Buffer Table (TAN Option FW-E002)

The menu is only shown if the TAN option is activated.

Parameter Setting ▶ System Control ▶ Buffer Table

See also

→ *pH Buffer Table: Entry of Individual Buffer Set (FW-E002), p. 186*

6.4.13 Concentration Table (TAN Option FW-E009)

The menu is only shown if the TAN option is activated.

Parameter Setting ▶ System Control ▶ Concentration Table

See also

→ *Concentration Determination (FW-E009), p. 187*

6.4.14 Restore Factory Settings

Allows the parameters to be reset to their factory settings:

Parameter Setting ▶ System Control ▶ Restore Factory Settings

NOTICE! After confirming with "Yes", all individual parameter settings are overwritten with the factory settings.

6.4.15 Passcode Entry

Passcodes (Factory Setting)

Calibration	1147
Maintenance	2958
Operator Level	1246
Administrator Level	1989

Passcodes can be changed or deactivated in the **Passcode Entry** submenu:

Parameter Setting ▶ System Control ▶ Passcode Entry

Note: The passcode for the administrator level cannot be deactivated.

Note: If you lose the passcode for the administrator level, system access is locked! The manufacturer can generate a rescue TAN. If you have any questions, please contact Knick Elektronische Messgeräte GmbH & Co. KG using the information provided on the last page of this document.

6.5 Parameter Setting, General

Note: Function check (HOLD) is active.

Submenu	Description
Language	User interface language: German (factory setting), English, French, Italian, Spanish, Portuguese, Chinese, Korean, Swedish
Units/Formats	Temperature unit °C (factory setting) or °F. Other units and formats depending on the selected process variable, e.g., pressure in mbar, kPa, psi Display format pH xx.xx or xx.x
Measurement Display	Values to be displayed (up to 8) → <i>Configuring the Measurement Display, p. 49</i>
Display	Display color, brightness, and display auto-off (factory setting: none) → <i>Display, p. 54</i>
Measurement recorder	TAN option FW-E103: Recording measured and additional values → <i>Measurement Recorder (FW-E103), p. 201</i>

6.5.1 Configuring the Measurement Display

Parameter Setting ▶ General ▶ Measurement Display

01. Set the **number** of values to be displayed:
 2 values (1 channel), 2 values (2 channels), 4 values (2 channels),
 2 values, 4 values, 6 values, 8 values
02. As required, assign channels and variables to be displayed.
03. Confirm with **enter**.

Measurement Display, Example with 2 Values

Selection	Result
Selection of any two variables:	

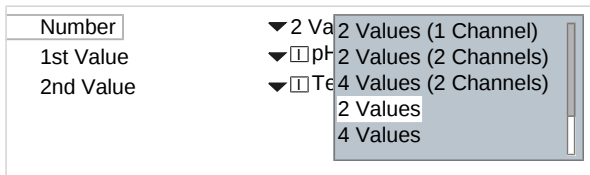

Select number of values.
 Confirm with **enter**.

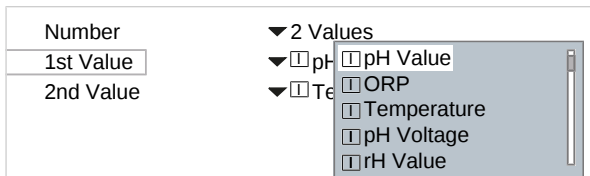

Select first variable.
 Confirm with **enter**.

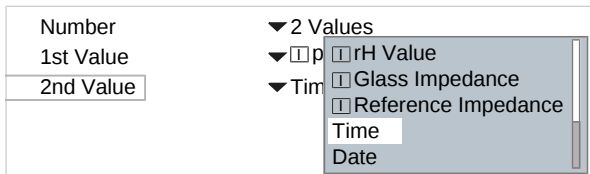

Select second variable.
 Confirm with **enter**.
 Set further parameters with the **left softkey: Back**.
 End parameter setting with the **right softkey: Back to Meas**.

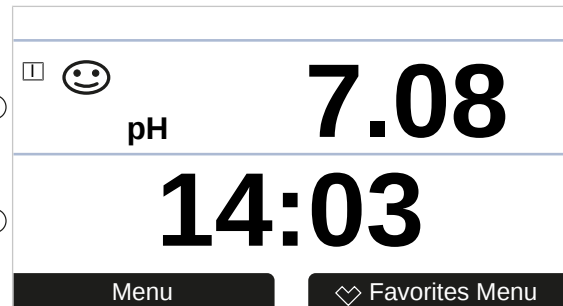

- (1) First value
- (2) Second value

Measurement Display, Example with 2 Values (1 Channel)

Selection	Result
Select two variables in one measuring channel:	

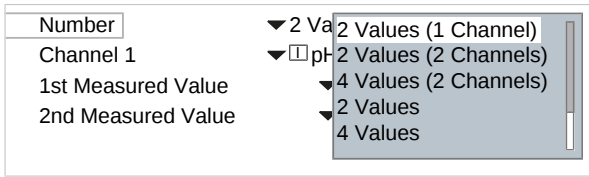

Select number of values and channels.
Confirm with **enter**.

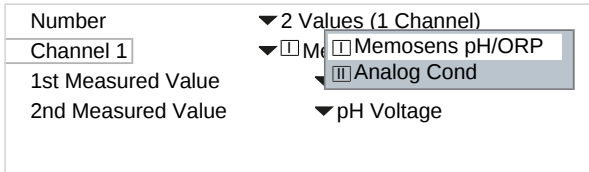

Assign a sensor to the channel.
Confirm with **enter**.

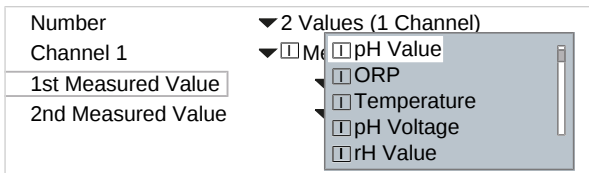

Select the first variable for channel I.
Confirm with **enter**.

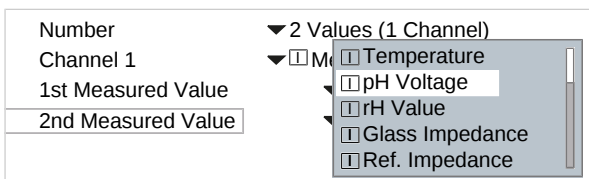

Select the second variable for channel I.
Confirm with **enter**.
Set further parameters with the **left softkey: Back**.
End parameter setting with the **right softkey: Back to Meas**.

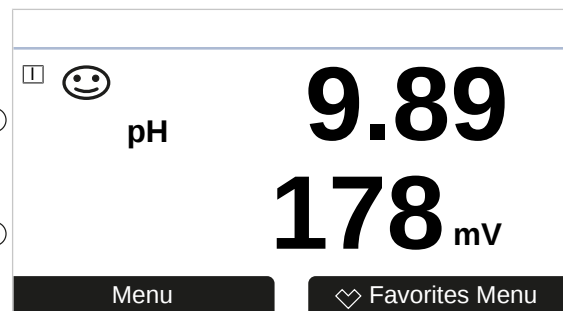

- (1) First value in channel I
- (2) Second value in channel I

Measurement Display, Example with 2 Values (2 Channels)

Selection	Result
-----------	--------

Select two variables in two measuring channels:

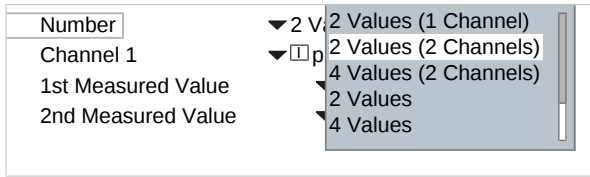

Select number of values and channels.
Confirm with **enter**.

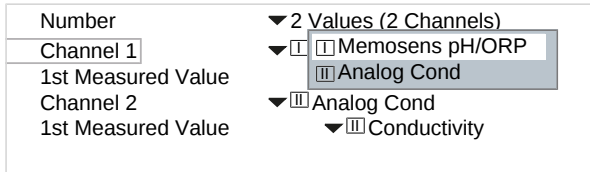

Assign a sensor to the first channel.
Confirm with **enter**.

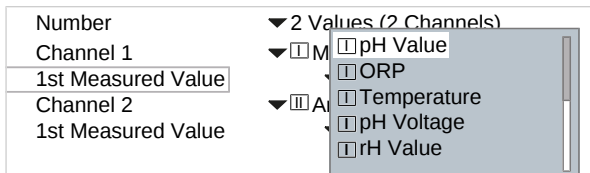

Select the variable for the first channel.
Confirm with **enter**.

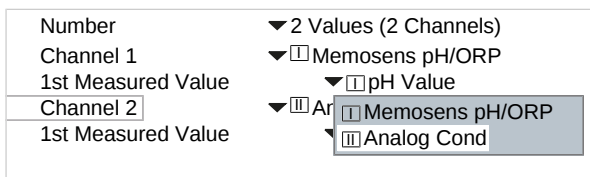

Assign a sensor to the second channel.
Confirm with **enter**.

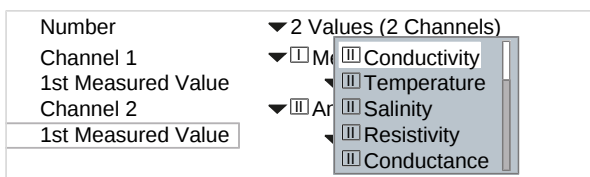

Select the variable for the second channel.
Confirm with **enter**.
Set further parameters with the **left softkey: Back**.
End parameter setting with the **right softkey: Back to Meas**.

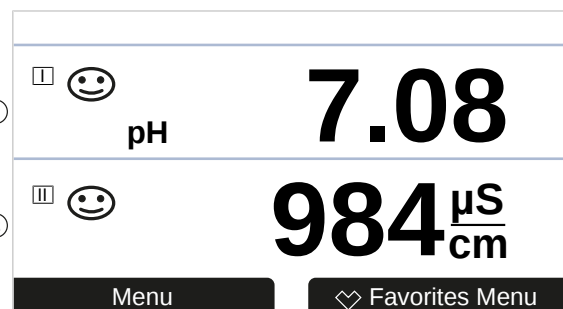

- (1) First value in channel
- (2) Second value in channel II

Measurement Display, Example with 4 (6, 8) Values

Selection	Result
-----------	--------

Select any four (six, eight) variables:

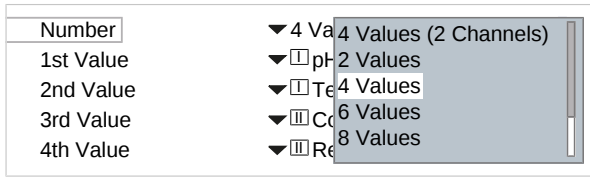

Select number of values.
Confirm with **enter**.

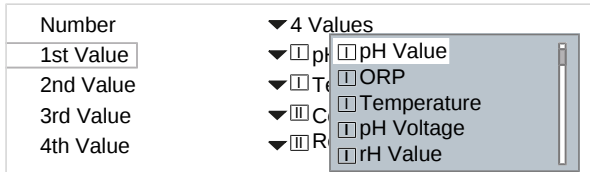

Select first variable.
Confirm with **enter**.

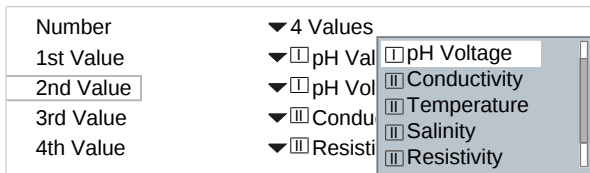

Select second variable.
Confirm with **enter**.

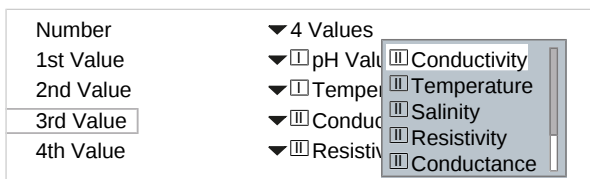

Select third variable.
Confirm with **enter**.

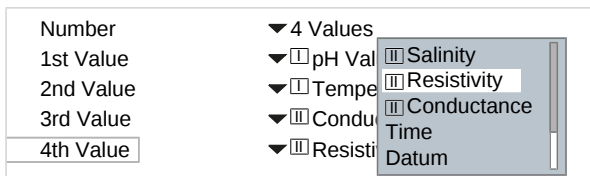

Select fourth variable.
Confirm with **enter**.
Set further parameters with the **left softkey Back**.
End parameter setting with the **right softkey: Back to Meas**.

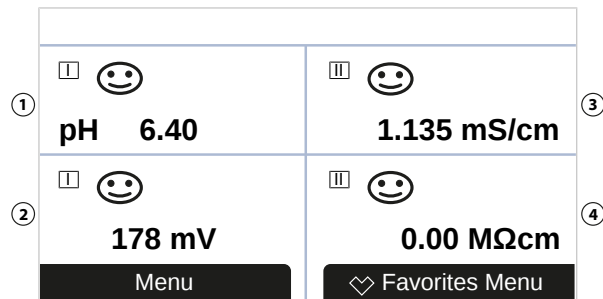

- (1) First value
- (2) Second value
- (3) Third value
- (4) Fourth value

Measurement Display, Example with 4 Values (2 Channels)

Selection	Result
Select four variables in two measuring channels:	

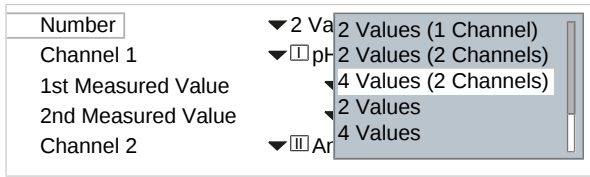

Select number of values and channels.
Confirm with **enter**.

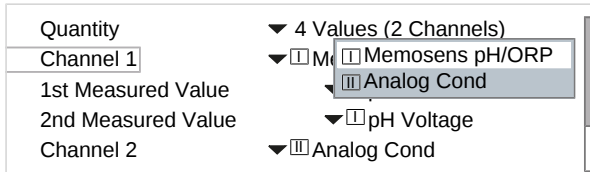

Assign a sensor to the first channel.
Confirm with **enter**.

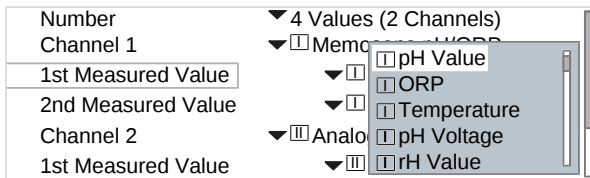

Select the first variable for the first channel.
Confirm with **enter**.

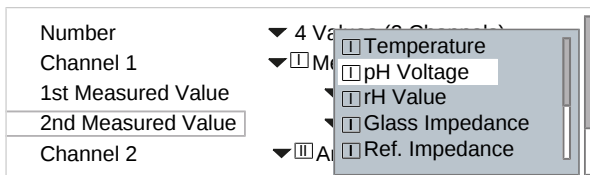

Select the second variable for the first channel.
Confirm with **enter**.

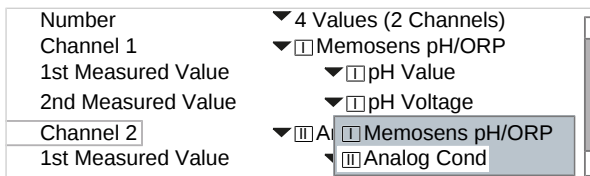

Assign a sensor to the second channel.
Confirm with **enter**.

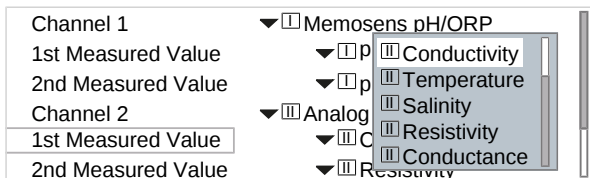

Select the first variable for the second channel.
Confirm with **enter**.

Selection	Result
<div style="border: 1px solid gray; padding: 5px;"> <ul style="list-style-type: none"> Channel 1 <ul style="list-style-type: none"> ▼ [I] Memosense pH/ORP ▼ [I] pH <ul style="list-style-type: none"> [II] Conductivity [II] Temperature Channel 2 <ul style="list-style-type: none"> ▼ [II] Analog <ul style="list-style-type: none"> [II] Salinity [II] Resistivity [II] Conductance ▼ [II] C <ul style="list-style-type: none"> [II] Resistivity </div> <p>Select the second variable for the second channel. Confirm with enter. Set further parameters with the left softkey: Back. End parameter setting with the right softkey: Back to Meas.</p>	<p>(1) First value in channel I (2) Second value in channel I (3) First value in channel II (4) Second value in channel II</p>

6.5.2 Display

It is possible to change the color and brightness of the display. The following settings are possible:

Menu item	Description
Display Color	White, NE107 (factory setting): If a NAMUR message is present for a measured value, the measured value has backlighting in accordance with the NAMUR color. Limits at which a message is generated can be defined for the "Failure" and "Out of Specification" messages. Parameter Setting ▶ [I] [II] [Sensor] ▶ Messages ▶ Messages [Process Variable] ▶ Monitoring
Brightness	Factory setting: 80 %
Shutdown	None (factory setting), after 5 min, after 30 min

The settings are made in the **Display** submenu:

Parameter Setting ▶ General ▶ Display

Note on Display Auto-off

The display switches off completely 5 or 30 minutes after the last keystroke is registered. Press any key to switch the display back on.

6.5.3 Measurement Recorder (TAN Option FW-E103)

The measurement recorder logs measured values and additional values depending on its parameter setting. The last 100 entries are graphically presented on the display of the Stratos Multi.

The menu is only shown if the TAN option is activated.

Parameter Setting ▶ General ▶ Measurement Recorder

See also

→ *Measurement Recorder (FW-E103)*, p. 201

6.6 Inputs/Outputs

The following inputs and outputs are available:

- Two current outputs ¹⁾ 0/4 ... 20 mA for transmitting variables such as measured value or temperature (factory setting); active or passive configuration possible → *Current Outputs, p. 55*
- Two freely configurable floating switching outputs ²⁾ → *Relay Contacts, p. 58*
- One digital control input OK1 → *Control Inputs, p. 62*

6.6.1 Current Outputs

The current outputs are deactivated ex works.

The current outputs cannot be enabled in EtherNet/IP mode.

The following settings are possible:

Menu item	Description						
Usage	Enable/disable current output.						
Process Variable	Selection of all available process variables						
Current Range	4 ... 20 mA or 0 ... 20 mA						
Characteristic	Linear Trilinear (entry of additional vertex points required) Function (entry of a 50% point required) Logarithmic → <i>Characteristic Curves, p. 56</i> Table (with TAN option FW-E006 "Current characteristic") → <i>Current Characteristic (FW-E006), p. 187</i>						
Output	Output current range 4 ... 20 mA or 0 ... 20 mA						
Start 0(4) mA	Start of measuring span						
End 20 mA	End of measuring span						
Output Filter	Input of a filter time constant. → <i>Output Filter, p. 57</i>						
Function Check	Current output behavior in Function Check mode. <table border="1" data-bbox="489 1288 1422 1433"> <tbody> <tr> <td>Curr. Measured Value</td> <td>The currently measured value appears at the current output.</td> </tr> <tr> <td>Last Measured Value</td> <td>The last measured value is held at the current output.</td> </tr> <tr> <td>Fixed Value</td> <td>The current output supplies a fixed value of 0 ... 22 mA.</td> </tr> </tbody> </table>	Curr. Measured Value	The currently measured value appears at the current output.	Last Measured Value	The last measured value is held at the current output.	Fixed Value	The current output supplies a fixed value of 0 ... 22 mA.
Curr. Measured Value	The currently measured value appears at the current output.						
Last Measured Value	The last measured value is held at the current output.						
Fixed Value	The current output supplies a fixed value of 0 ... 22 mA.						
Behavior during Messages	<table border="1" data-bbox="489 1444 1422 1552"> <tbody> <tr> <td>Failure</td> <td>Current output behavior in case of failure message: Off, 3.6 mA, 22 mA</td> </tr> <tr> <td>Delay</td> <td>Input of a delay of 0 ... 600 s in the event of a failure message.</td> </tr> </tbody> </table>	Failure	Current output behavior in case of failure message: Off, 3.6 mA, 22 mA	Delay	Input of a delay of 0 ... 600 s in the event of a failure message.		
Failure	Current output behavior in case of failure message: Off, 3.6 mA, 22 mA						
Delay	Input of a delay of 0 ... 600 s in the event of a failure message.						

The settings are made in the **Current Outputs** submenu:

Parameter Setting ▶ Inputs/Outputs ▶ Current Outputs

¹⁾ Not with activated EtherNet/IP communication

²⁾ Only with activated EtherNet/IP communication

Setting the Measuring Span: Start (0/4 mA) and End (20 mA)

Example measuring span pH 0 ... 14

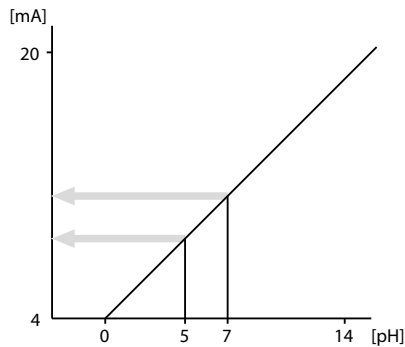

Example measuring span pH 5 ... 7

Advantage: Higher resolution in range of interest

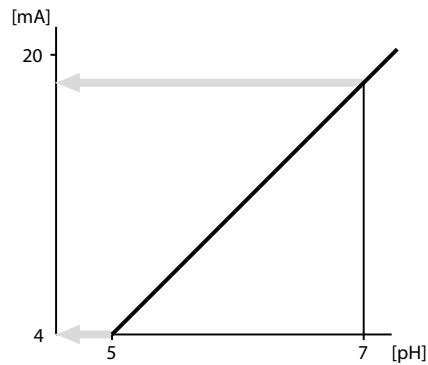

Characteristic Curves

Linear Characteristic

The process variable is represented by a linear output current curve.

Output 4 ... 20 mA, span pH 0 ... 14

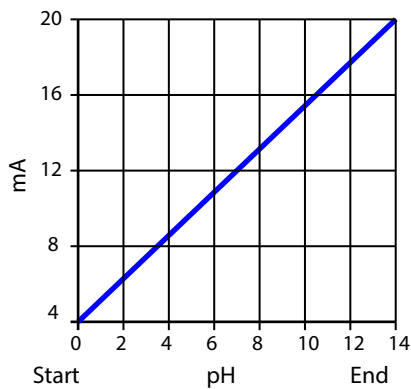

Output 4 ... 20 mA, span pH 5 ... 9

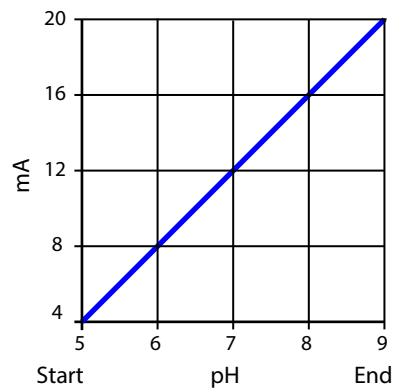

Trilinear/Bilinear Characteristic

Requires two additional vertex points to be entered.

Trilinear: Vertex points (1) and (2) are different values.

Bilinear: Vertex points (1) and (2) are the same values.

Output 4 ... 20 mA, span pH 0 ... 14

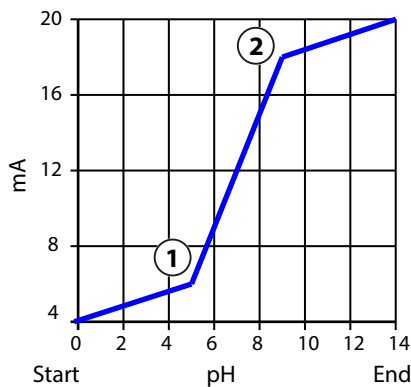

Output 4 ... 20 mA, span pH 5 ... 9

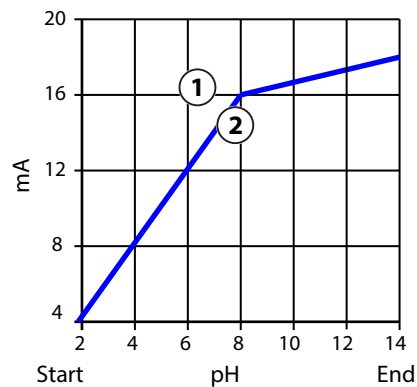

Function/Logarithmic Characteristic

Non-linear curve of the output current, enables measurement across multiple decades, e.g., the measurement of very small measured values with high resolution and measurement of large measured values (low resolution). Requires entry of value for 50% output current.

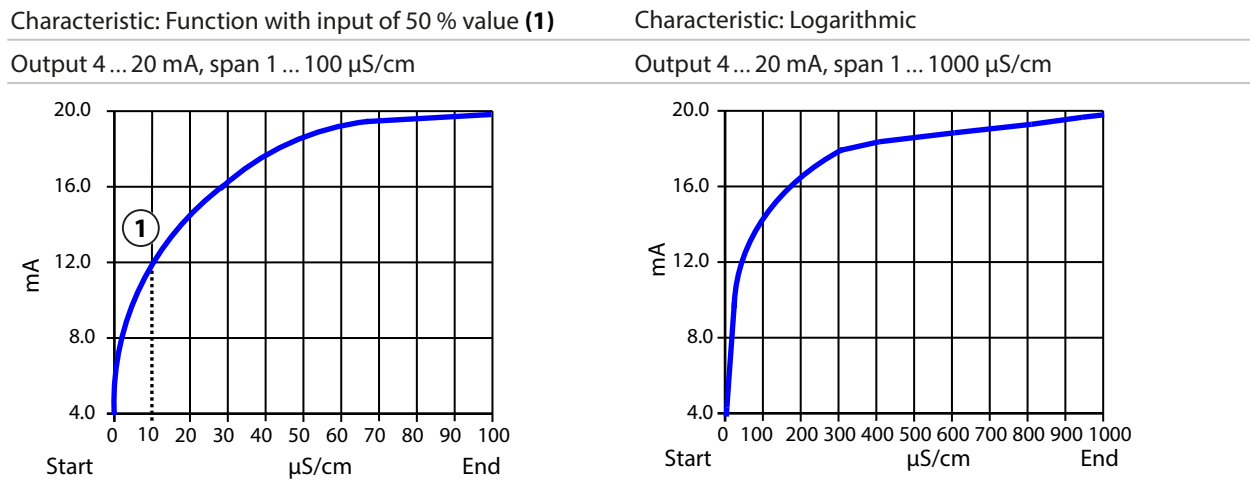

Output Filter

To smooth the current output, a low-pass filter with adjustable time interval can be switched on. When there is a jump at the input (100 %), the output level is at 63 % after the time interval has been reached. The time interval can be set in the 0 ... 120 s range. If the time interval is set to 0 s, the current output follows the input variable.

Note: The filter acts only on the current output, not on the display or the limit values.

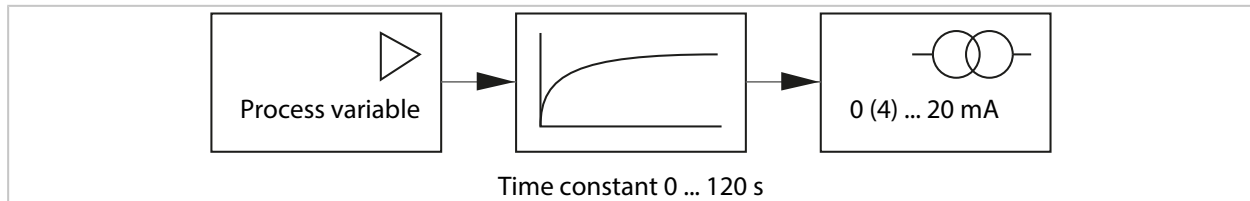

Current During Function Check (HOLD)

Depending on the parameter setting, the current outputs switch to one of the following states:

- Currently measured value: The currently measured value appears at the current output.
- Last measured value (factory setting): The last measured value is held at the current output.
- Fixed value: The current output supplies a fixed value of 0 ... 22 mA.

Message when the Current Range is Exceeded

In the ex works state, the "Failure" message is generated when the output current range is exceeded (< 3.8 mA or > 20.5 mA). This setting can be changed in the parameter settings for the respective measuring channel in the Messages menu:

Parameter Setting ▶ [I] [II] [Sensor] ▶ Messages

6.6.2 Relay Contacts

Up to two free relay contacts K1, K2 can be configured. The relay contacts are only available if EtherNet/IP communication is enabled.

The contact parameters can be set as normally open or normally closed contact independently of each other.

Menu item	Selection	Description
Contact Type	Normally Open N/O	The relay contact closes when it is activated.
	Normally Closed N/C	The relay contact opens when it is activated.

The additional setting options depend on the selected usage.

The settings are made in the **Relay Contacts** submenu:

Parameter Setting ▶ **Inputs/Outputs** ▶ **Relay Contacts**

Notes on wiring → *Relay Contacts: Protective Wiring, p. 28*

Usage of Relay Contacts

The following usages are possible:

- Off
- Failure
- Maintenance Required
- Out of Specification
- Function check
- Limit Value
- Rinse Contact
- Rinse Contact (Channel) (if using two channels)
- Parameter Set B Active
- USP output (with conductivity sensor only)
- Sensoface
- Sensoface (Channel) (if using two channels)
- DO 1 / DO 2

Usage: Failure

01. **Inputs/Outputs** ▶ **Relay Contacts** .
02. Select the desired contact with **up/down arrow keys** and **enter**.
03. Specify **Usage** : "Failure"
04. Set the contact parameters.

Failure is active:

- If a set value has exceeded or fallen below "Failure Limit Hi" or "Failure Limit Lo" respectively
- If the measuring range limits of the device were exceeded
- For other failure messages

This means that the measuring equipment no longer operates properly or that process parameters have reached a critical value.

The relay contact is not activated for "Function Check" (HOLD).

The measurement display has red backlighting (can be switched off):

Parameter Setting ▶ **General** ▶ **Display** ▶ **Display Color** : "NE107" (factory setting)

Usage: Maintenance Required

01. [Inputs/Outputs](#) ▶ [Relay Contacts](#) .
02. Select the desired contact with *up/down arrow keys* and *enter*.
03. Specify [Usage](#) : Maintenance Required
04. Set the contact parameters.

Maintenance Required is active:

- If messages that require maintenance appear

This means that the equipment is still operating properly but should be serviced, or that process parameters have reached a value requiring intervention. Typical example: The transmitter detected a worn sensor.

The relay contact is not activated for "Function Check" (HOLD).

The measurement display has blue backlighting (can be switched off):

[Parameter Setting](#) ▶ [General](#) ▶ [Display](#) ▶ [Display Color](#) : "NE107" (factory setting)

Usage: Out of Specification

01. [Inputs/Outputs](#) ▶ [Relay Contacts](#) .
02. Select the desired contact with *up/down arrow keys* and *enter*.
03. Specify [Usage](#) : "Out of Spec."
04. Set the contact parameters.

Out of specification is active:

- If a value has exceeded or fallen below "Out of Specification Hi" or "Out of Specification Lo"
- If the device has detected deviations from the permitted ambient conditions or process conditions
- If faults indicating that the measurement uncertainty is probably greater than to be expected under normal operating conditions are present

The relay contact is not activated for "Function Check" (HOLD).

The measurement display has yellow backlighting (can be switched off):

[Parameter Setting](#) ▶ [General](#) ▶ [Display](#) ▶ [Display Color](#) : "NE107" (factory setting)

Usage: Function Check

01. [Inputs/Outputs](#) ▶ [Relay Contacts](#) .
02. Select the desired contact with *up/down arrow keys* and *enter*.
03. Specify [Usage](#) : Function check
04. Set the contact parameters.

Function Check (HOLD) is active:

- For calibration (only the relevant channel)
- For maintenance (Current Source, Relay Test)
- For parameter setting on the operator level and the administrator level
- During an automated rinse cycle

The current outputs respond as configured:

[Parameter Setting](#) ▶ [Inputs/Outputs](#) ▶ [Current Outputs](#) ▶ [Function Check](#)

The measurement display has orange backlighting (can be switched off):

[Parameter Setting](#) ▶ [General](#) ▶ [Display](#) ▶ [Display Color](#) : "NE107" (factory setting)

Usage: Limit Value

01. Inputs/Outputs ▶ Relay Contacts .
02. Select the desired contact with *up/down arrow keys* and *enter*.
03. Specify Usage :“Limit Value”
04. Set the contact parameters.

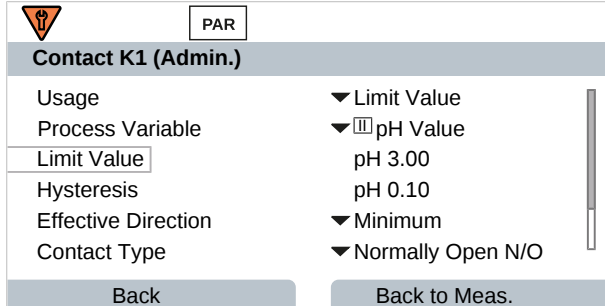

Hysteresis

Hysteresis prevents small fluctuations in the measured value around the limit from constantly triggering a switching operation.

Hysteresis is adjustable and can be activated with an ON/OFF delay time.

In the measurement display, an icon is used to indicate if the limit has been exceeded or fallen below.

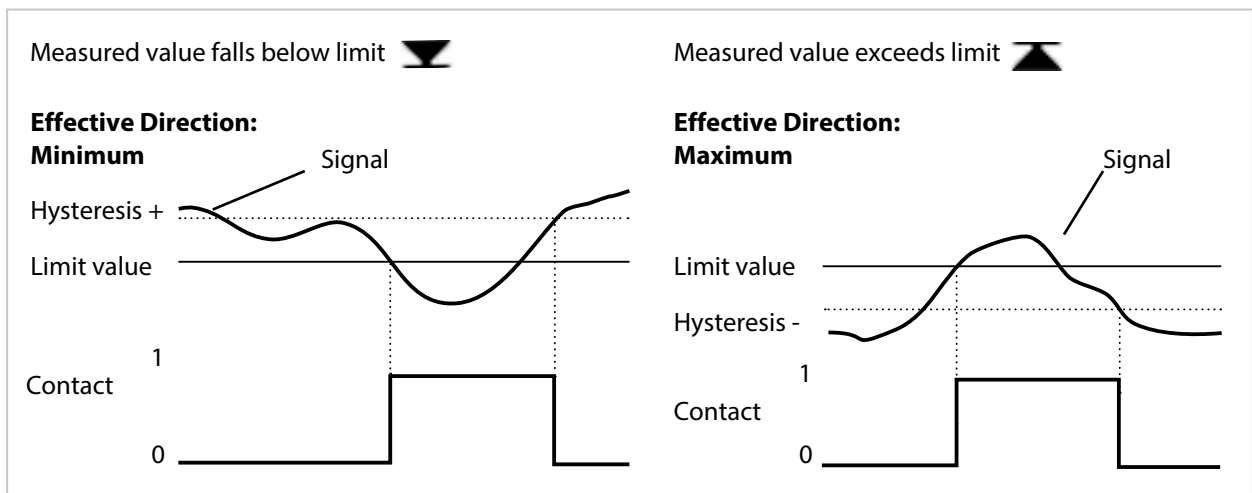

Usage: Rinse Contact

Relay contacts can be used to signal a rinse process.

Time Response



Note: Function Check (HOLD) is activated from the start of the lead time until the end of the OFF delay. The current outputs and remaining relay contacts behave in accordance with the parameter settings.

Configuring the Rinse Contact

01. Inputs/Outputs ▶ Relay Contacts ▶ Contact K...
02. Usage "Rinse Contact"
03. If Usage: "Rinse Contact (Channel)" is selected:
Select the channel.
04. Select Contact Type (e.g., "Normally Open N/O").
05. Enter the Rinsing Interval .
06. Enter the Rinse Lead Time .
07. Enter the Rinse Duration .
08. Enter the Meas. Lead Time .
09. Logbook Entry "Off/On"

Notes for Configuration of the "Rinse Contact" Function

- Up to 3 rinse functions (contacts K1 ... K3) can be configured independently of each other.
- Multiple rinse functions are not synchronized with each other.
- The "Function Check" (HOLD) operating state (e.g., during parameter setting) delays the execution of the "Rinse Contact" function.

If Usage "Rinse Contact (Channel)" is selected, the contact is assigned to a sensor channel.
Advantage: The activated "Function Check" (HOLD) operating state only applies to the respective sensor channel.

Rinse Contact Usage Example 1

01. Parameter Setting Contact K1: Usage "Limit Value" (for sensor channel 1)
02. Parameter Setting Contact K2: Usage "Rinse Contact"
03. Contact K1 is switched due to an off-limit condition.
04. Contact K2 is switched by a rinse function.
 - ✓ For the overall device, the "Function Check" (HOLD) operating state is activated. Contact K1 is deactivated although the off-limit condition was not remedied yet.

Rinse Contact Usage Example 2

01. Parameter Setting Contact K1: Usage "Limit Value" (for sensor channel 1)
02. Parameter Setting Contact K2: Usage "Rinse Contact (Channel)"
03. Contact K1 is switched due to an off-limit condition.
04. Contact K2 is switched by a rinse function.
 - ✓ For sensor channel 2, the "Function Check" (HOLD) operating state is activated. Contact K1 remains active.

Usage: USP Output

Can be activated when using a conductivity sensor and the USP function → *USP Function, p. 84*

01. Inputs/Outputs ▶ Relay Contacts .
02. Select the desired contact with *up/down arrow keys* and *enter*.
03. Specify Usage: "USP Output"
04. Assign USP channel .
05. Set the contact parameters.

Usage: Sensoface

Sensoface messages can be output via a relay contact.

If using two sensors, the corresponding Sensoface messages can be assigned to different contacts:

01. Inputs/Outputs ▶ Relay Contacts .
02. Select the desired contact with *up/down arrow keys* and *enter*.
03. Specify Usage : "Sensoface (Channel)"
04. Select Channel .

Contact K1 (Administrator)	
Usage	▼ Sensoface Channel
Channel	▼ Mem <input type="checkbox"/> Memosens pH
Contact Type	▼ N/O <input type="checkbox"/> Memosens Cond
ON Delay	0 s
OFF Delay	0 s
Back	

05. Set the contact parameters.

Usage: DO 1 / DO 2

If EtherNet/IP communication is enabled, DO 1 can be assigned to relay contact K1 (REL 1), DO 2 to relay contact K2 (REL 2).

01. Inputs/Outputs ▶ Relay Contacts .
02. Select the desired contact with the *up/down arrow keys* and *enter*.
03. Usage : DO 1 / DO 2
04. Set the contact parameters.

See also

→ *Connections to the Controller, p. 109*

6.6.3 Control Inputs

Stratos Multi features a digital optocoupler input OK2.

The following functions (depending on the parameter setting) can be started via the control signals:

Input OK1 : off, parameter set selection, flow, function check total, or function check channel

- The function of optocoupler input OK1 is defined in the System Control :
Parameter Setting ▶ System Control ▶ Function Control → *Function Control, p. 45*

The switch level for the control signal must be specified:

Parameter Setting ▶ Inputs/Outputs ▶ Control Inputs ▶ Input OK...

Input Level : Active 10 ... 30 V or active < 2 V

6.7 Sensor Selection [I] [II]

Note: Function check (HOLD) is active.

Stratos Multi is factory-set to the pH value measurement method with Memosens sensor. This measurement method also provides redox potential measurement. The measurement method can be changed to measure conductivity or oxygen in the **Parameter Setting** menu:

To prepare Stratos Multi for measurements, the operating mode of the used measuring channel must be set:

Parameter Setting ▶ **Sensor Selection [I] [II]**

Sensor Selection [I] (measuring channel I): Memosens sensor or SE740 optical oxygen sensor (LDO)

Sensor Selection [II] (measuring channel II): Second Memosens sensor, analog sensor, or ISM sensor (TAN option FW-E053) via measuring module

Automatic Process Variable Detection

If Memosens sensors are connected directly, the process variable can be set to "Auto". In this case, the sensor is automatically detected by the device, which sets itself to the correct process variable. This does not apply to the MK-MS095N Memosens module.

NOTICE! Parameters that are dependent on process variables (e.g., measurement display, current outputs, contacts, ...) are set separately; this step is not automatic.

If "Auto" is not used with a Memosens sensor, and in general when using analog sensors, the operating mode must be set to the used sensor. The parameters that are dependent on process variables can then be set when a sensor is not connected.

Power Out

The output voltage of terminal 6 is selected in the **Power Out** menu item: 3.1 V, 14 V, 24 V. This output voltage is used to supply power to special sensors or external transmitters. The voltage at terminal 6 is automatically adjusted when using the SE740 optical oxygen sensor. The menu item is then not available.

Identifying a Memosens Sensor

A connected Memosens sensor is displayed as follows: sensor name, manufacturer, serial number, date of last adjustment

All relevant and typical sensor parameters are automatically transferred to the Stratos Multi.

6.8 pH Process Variable

Note: Function check (HOLD) is active.

Note: After changing the process variable or measuring mode, Stratos Multi retains its settings but needs to be reconfigured.

Selecting a Memosens pH Sensor

Parameter Setting ▶ Sensor Selection [I] [II] ▶ Sensor Selection [I]

Selection of the Memosens pH sensor connected to the RS-485 interface (terminals 1 ... 5):

Process variable: Auto or pH
 Mode: Memosens
 Functionality: pH, ISFET or pH/ORP (depending on sensor type)

Selecting a Second Memosens pH Sensor

Parameter Setting ▶ Sensor Selection [I] [II] ▶ Sensor Selection [II]

Selection of a second Memosens pH sensor connected to the MK-MS095N measuring module:

Module: MK-MS
 Process variable: pH
 Mode: Memosens
 Functionality: pH, ISFET or pH/ORP (depending on sensor type)

Adjustable parameters for Memosens pH sensors Parameter Setting ▶ [I] [II] Memosens pH :

Submenu	Description
Input Filter	Enable/disable suppression of interference pulses.
Sensor Data → <i>Sensor Data, p. 67</i>	Enable/disable display of Sensoface messages and Sensoface icons.
Sensor Monitoring Details	Option to enter individual limit values for monitoring slope and zero point. Enable/disable Sensocheck sensor monitoring. Specify whether Sensocheck should generate a failure or maintenance required message. Option to enter individual values up to triggering a message for settling time, sensor wear, sensor operating time, and SIP counter; for pH/ORP sensor also CIP counter and autoclaving counter; for ISFET sensor also operating point and leakage current.
Tag Description	Entry of information about the measuring point and annotations (e.g., date of last maintenance)
Cal Presettings	Presetting of calibration mode with corresponding parameters, parameter configuration of drift check and calibration timer. → <i>Calibration Presettings, p. 70</i>
TC Process Medium	→ <i>Temperature Compensation of Process Medium, p. 71</i>
ORP / rH Value	With Memosens pH/ORP sensor: Selection of the reference electrode: Ag/AgCl, KCl 1 mol, Ag/AgCl, KCl 3 mol, Hg,Tl/TlCl, KCl 3.5 mol, Hg/Hg ₂ SO ₄ , K ₂ SO ₄ sat. Enable/disable ORP conversion to standard hydrogen electrode SHE. Calculate rH with or without factor.
Delta Function	Display deviations from a preset value (delta value): Output value = measured value – delta value → <i>Delta Function, p. 71</i>
Messages	Enable/disable messages for individual process variables or specify individual limit values. → <i>Messages, p. 72</i>

Selecting a Digital ISM pH Sensor (TAN Option FW-E053)

Parameter Setting ▶ Sensor Selection [I] [II] ▶ Sensor Selection [II]

Selection of an ISM pH sensor connected to the MK-PH015N measuring module:

Module: MK-PH
 Mode: ISM

Adjustable parameters for ISM pH sensors Parameter Setting ▶ [II] ISM pH :

Submenu	Description
Input Filter	Enable/disable suppression of interference pulses.
Sensor Data → <i>Sensor Data, p. 67</i>	Enable/disable display of Sensoface messages and Sensoface icons.
	Sensor Monitoring Details Entry option for individual limit values for monitoring slope, zero point, ORP offset, Sensocheck, reference electrode/glass electrode. Settling time, sensor operating time, TTM maintenance timer, DLI lifetime indicator, CIP/SIP counters, autoclaving counter. Specify whether to generate a failure or maintenance required message if values are exceeded.
	Tag Description Entry of information about the measuring point and annotations (e.g., date of last maintenance)
Cal Presettings	Presetting of calibration mode with corresponding parameters, parameter configuration of calibration timer and ORP check.
TC Process Medium	→ <i>Temperature Compensation of Process Medium, p. 71</i>
ORP / rH Value	Selection of the reference electrode: Ag/AgCl, KCl 1 mol, Ag/AgCl, KCl 3 mol, Hg,Tl/TlCl, KCl 3.5 mol, Hg/Hg ₂ SO ₄ , K ₂ SO ₄ sat.
	Enable/disable ORP conversion to standard hydrogen electrode SHE.
	Calculate rH with or without factor.
Delta Function	Display deviations from a preset value (delta value): Output value = measured value – delta value → <i>Delta Function, p. 71</i>
Messages	Enable/disable messages for individual process variables or specify individual limit values. → <i>Messages, p. 72</i>

Additional information on use of ISM sensors → *Digital ISM-Sensors (FW-E053), p. 198*

Selecting an Analog pH Sensor

Parameter Setting ▶ Sensor Selection [I] [II] ▶ Sensor Selection [II]

Selection of a pH sensor or pH/ORP sensor connected to the MK-PH015N measuring module:

Module: MK-PH
 Mode: Analog

Adjustable parameters for analog sensors Parameter Setting ▶ [II] Analog pH :

Submenu	Description
Input Filter	Enable/disable suppression of interference pulses.
Sensor Data → <i>Sensor Data, p. 67</i>	Sensoface, temperature monitoring, and the details of sensor monitoring can be set, depending on the sensor type.
	Temperature Detection Select temperature detector; set measuring and calibration temperatures.
	Sensor Monitoring Details Set slope, zero point, Sensocheck of reference and glass electrodes, and select settling time.
Cal Presettings	Presetting of calibration mode and calibration timer with corresponding parameters. → <i>Calibration Presettings, p. 70</i>

Submenu	Description
TC Process Medium	→ <i>Temperature Compensation of Process Medium, p. 71</i>
ORP / rH Value	With pH/ORP sensor: Selection of the reference electrode: Ag/AgCl, KCl 1 mol, Ag/AgCl, KCl 3 mol, Hg, Tl/TlCl, KCl 3.5 mol, Hg/Hg ₂ SO ₄ , K ₂ SO ₄ sat. Enable/disable ORP conversion to standard hydrogen electrode SHE. Calculate rH with or without factor.
Delta Function	Display deviations from a preset value (delta value): Output value = measured value – delta value → <i>Delta Function, p. 71</i>
Messages	Enable/disable messages for individual process variables or specify individual limit values. → <i>Messages, p. 72</i>

Selecting an Analog Pfaudler pH Sensor with TAN Option FW-E017 (Pfaudler Sensors)

Parameter Setting ▶ Sensor Selection [I] [II] ▶ Sensor Selection [II]

Selection of a Pfaudler pH sensor connected to the MK-PH015N measuring module:

Module: MK-PH
Mode: Analog

Adjustable parameters for analog Pfaudler sensors Parameter Setting ▶ [II] Analog pH :

Submenu	Description														
Input Filter	Enable/disable suppression of interference pulses.														
Sensor Data → <i>Sensor Data, p. 67</i>	<table border="1"> <thead> <tr> <th>Sensor Type</th> <th>Description</th> </tr> </thead> <tbody> <tr> <td></td> <td>Pfaudler Standard (enameled pH sensor)</td> </tr> <tr> <td></td> <td>Pfaudler Diff. (enameled pH differential sensor)</td> </tr> <tr> <td></td> <td>Glass El. Diff. (pH differential sensor with glass electrode)</td> </tr> <tr> <td>Sensoface</td> <td>Set Sensoface.</td> </tr> <tr> <td>Temperature Detection</td> <td>Select temperature detector; set measuring and calibration temperatures.</td> </tr> <tr> <td>Sensor Monitoring Details</td> <td>Set slope, zero point, and Sensocheck of reference and glass electrodes. Select "Individual" monitoring and enter sensor values in accordance with sensor data sheet.</td> </tr> </tbody> </table>	Sensor Type	Description		Pfaudler Standard (enameled pH sensor)		Pfaudler Diff. (enameled pH differential sensor)		Glass El. Diff. (pH differential sensor with glass electrode)	Sensoface	Set Sensoface.	Temperature Detection	Select temperature detector; set measuring and calibration temperatures.	Sensor Monitoring Details	Set slope, zero point, and Sensocheck of reference and glass electrodes. Select "Individual" monitoring and enter sensor values in accordance with sensor data sheet.
Sensor Type	Description														
	Pfaudler Standard (enameled pH sensor)														
	Pfaudler Diff. (enameled pH differential sensor)														
	Glass El. Diff. (pH differential sensor with glass electrode)														
Sensoface	Set Sensoface.														
Temperature Detection	Select temperature detector; set measuring and calibration temperatures.														
Sensor Monitoring Details	Set slope, zero point, and Sensocheck of reference and glass electrodes. Select "Individual" monitoring and enter sensor values in accordance with sensor data sheet.														
Cal Presettings	Presetting of calibration mode with corresponding parameters. → <i>Calibration Presettings, p. 70</i>														
TC Process Medium	→ <i>Temperature Compensation of Process Medium, p. 71</i>														
Delta Function	Display deviations from a preset value (delta value): Output value = measured value – delta value → <i>Delta Function, p. 71</i>														
Messages	Enable/disable messages for individual process variables or specify individual limit values. → <i>Messages, p. 72</i>														

Additional information on use of Pfaudler sensors → *Pfaudler Sensors (FW-E017), p. 192*

6.8.1 Sensor Data

Memosens Sensors

Memosens sensors provide relevant sensor data automatically.

Analog Sensors

The sensor type must be selected if using analog sensors:

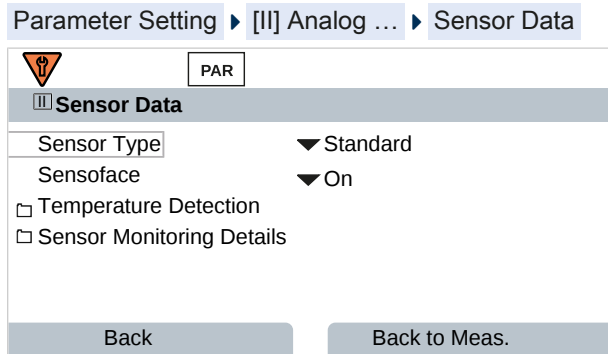

01. In **Temperature Detection**, select the used temperature probe and whether the temperature is to be measured automatically or manually during measurement and/or calibration.

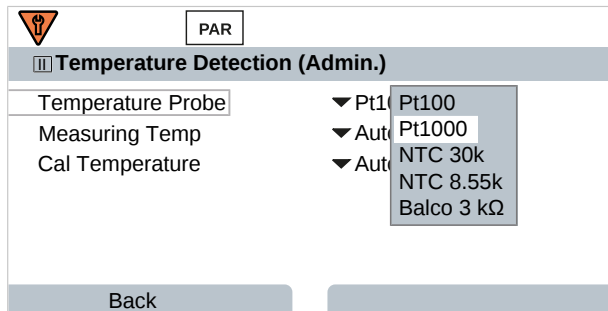

Sensoface

The Sensoface icons provide users with diagnostic information on the wear and required maintenance of the sensor. In measuring mode, an icon (happy, neutral, or sad smiley) is shown on the display to reflect the continuous monitoring of the sensor parameters.

You can set the current output parameters such that a Sensoface message generates a 22 mA error signal.

Parameter Setting > Inputs/Outputs > Current Outputs > Current Output I... > Behavior during Messages

Sensoface messages can also be output via a relay contact:

Parameter Setting > Inputs/Outputs > Relay Contacts > Contact K... > Usage → Usage: Sensoface, p. 62

If **Sensoface** is selected, the Sensoface messages of all channels are output via the selected contact.

If **Sensoface (Channel)** is selected, you can output the Sensoface messages of a specific channel via the selected contact.

Sensoface monitors the pH sensor on the basis of the following parameters: slope, zero point, glass impedance (if Sensoscheck is enabled), settling time, calibration timer, wear

Enabling/Disabling Sensoface



Sensoface is enabled and disabled in the **Sensor Data** submenu:

Parameter Setting > [I] [II] [Sensor] > Sensor Data

Note: After a calibration, a smiley is always displayed for confirmation, even if Sensoface is disabled.

Adjusting Sensor Monitoring

01. **Sensor Data** ▶ **Sensor Monitoring Details**
02. Open a sensor parameter, e.g., **Slope**.
03. Set **Monitoring** of the slope to automatic or individual.
04. If you select "Individual": The nominal slope and the min./max. limit values can be entered.
05. In the **Message** menu item, select whether and how off-limit values should be displayed:

Off	No message, but the parameter is still shown in the Diagnostics menu and on the sensor diagram.
Failure	A failure message is shown for off-limit conditions; the corresponding NAMUR icon  is displayed. If "Display Color NE107" is set, the measurement display is shown with red backlighting.
Maintenance	A maintenance required message is shown in off-limit conditions; the corresponding NAMUR icon  is displayed. If "Display Color NE107" is set, the measurement display is shown with blue backlighting.
06. Set the sensor monitoring details for other sensor data, e.g., zero point, Sensocheck, settling time, sensor wear, or sensor operating time.
07. With **left softkey: Back**, apply the sensor monitoring settings and set additional parameters.
Or
With the **right softkey: Back to Meas.**, confirm the sensor monitoring settings and end the function check (HOLD).

CIP/SIP Counters

CIP/SIP counters are available for the following pH sensor types:

	Memosens pH	Memosens pH/ORP	ISM pH/ORP ¹⁾
CIP Counters		+	+
SIP Counters	+	+	+

CIP/SIP cycles are used to clean or sterilize wetted parts in the process. Depending on the application, either one chemical (alkaline solution, water) or multiple chemicals (alkaline solution, water, acidic solution, water) are used.

- CIP temperature > 55 °C/131 °F
- SIP temperature > 115 °C/239 °F

When a sensor is installed, cleaning (cleaning in place) and sterilization (sterilization in place) cycles are counted to measure the load on the sensor, e.g., in biotechnology applications.

Note: If measurements are generally taken at high temperatures (> 55 °C/131 °F), the counters should be switched off.

When a CIP/SIP counter is enabled, a maximum number of cycles can be entered. A message can be used to signal that the specified counter status is reached.



Note: A CIP or SIP cycle is only entered into the logbook 2 hours after the start to ensure that the cycle is complete.

Note: With Memosens sensors, an entry is also made in the sensor.

¹⁾ With TAN option FW-E053

Setting CIP/SIP Counters

01. Sensor Monitoring Details ▶ CIP Counter / SIP Counter
02. Monitoring : "Off" or "Individual"
03. If you select "Individual": Enter the maximum number of CIP/SIP cycles.
04. In the Message menu item, select whether and how off-limit values should be displayed:

Off	No message.
Failure	A failure message is shown for off-limit conditions; the corresponding NAMUR icon  is displayed. If "Display Color NE107" is set, the measurement display is shown with red backlighting.
Maintenance	A maintenance required message is shown in off-limit conditions; the corresponding NAMUR icon  is displayed. If "Display Color NE107" is set, the measurement display is shown with blue backlighting.

Autoclaving Counter



An autoclaving counter is available for the following sensor types:

- Memosens pH/ORP
- ISM pH/ORP (with TAN option FW-E053)

Autoclaving cycles are counted to help measure the load on the sensor.

Setting the Autoclaving Counter

01. Sensor Monitoring Details ▶ Autoclaving Counter
02. Monitoring : "Off" or "Individual"
03. If you select "Individual": Enter the maximum number of autoclaving cycles.
04. In the Message menu item, select whether and how off-limit values should be displayed:

Off	No message.
Failure	A failure message is shown for off-limit conditions; the corresponding NAMUR icon  is displayed. If "Display Color NE107" is set, the measurement display is shown with red backlighting.
Maintenance	A maintenance required message is shown in off-limit conditions; the corresponding NAMUR icon  is displayed. If "Display Color NE107" is set, the measurement display is shown with blue backlighting.

After each autoclaving process, the autoclaving counter must be manually incremented in the Maintenance menu of the device:

Maintenance ▶ [I][II] [Sensor] ▶ Autoclaving Counter

6.8.2 Calibration Presettings

The calibration presettings can be defined in the parameter settings or adjusted directly in the Calibration menu prior to the calibration.

Calibration Mode : Presetting of calibration mode, e.g., Calimatic, Manual, Product Calibration, Data Entry, Temperature

If Calimatic automatic calibration is selected, the buffer set to be used must also be selected.

Calibration Points : Selection of how many calibration points should be used in the calibration

Drift Check : Sets the sensitivity of the drift check (fine, standard, coarse)

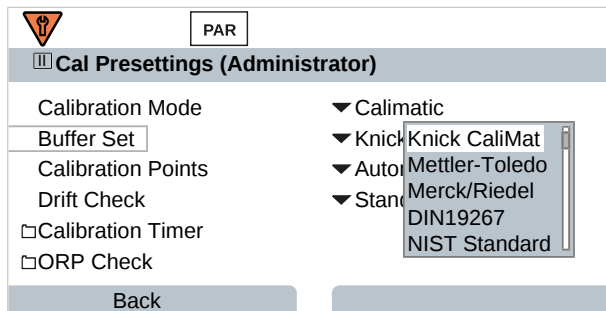

Calibration Timer

When a preset calibration interval elapses, the calibration timer generates a message text to indicate that calibration is required. If "Auto" is selected, the interval is set to 168 h. If "Individual" is selected, a customized interval can be specified.

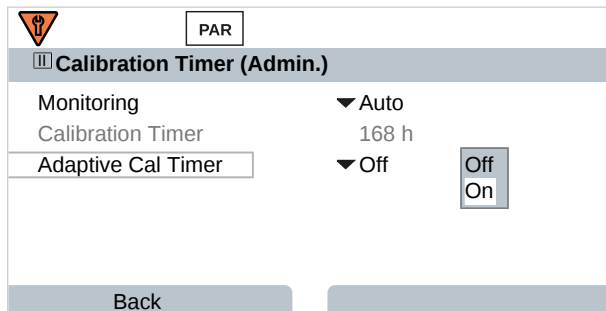

Note: If Sensoface is enabled, a neutral smiley is displayed once 80 % of the interval has expired. Once the entire interval has expired, a sad smiley is shown, a Maintenance Required message is generated, and the corresponding NAMUR icon is displayed and the measurement display is shown with blue backlighting (display color: NE107). If the current outputs have the correct parameter setting, a 22 mA error signal is generated.

Adaptive Cal Timer : The time until the next calibration is automatically shortened, depending on the temperature and pH value.

Old sensor = timer elapses faster.

The following measuring conditions shorten the adaptive calibration timer interval:

- Temperatures above 30 °C/86 °F
- pH ranges below pH 2 or above pH 12

The message text is displayed in the **Diagnostics** menu:

Diagnostics ▶ **Message List**

The calibration timer is reset to the initial value after each calibration.

The settings are made in the **Cal Presettings** submenu:

Parameter Setting ▶ **[I] [II] [Sensor]** ▶ **Cal Presettings**

6.8.3 Temperature Compensation of Process Medium

Note: If temperature compensation of the process medium is enabled, "TC" is shown on the display in measuring mode.

The following selection is available for temperature compensation:

- Linear with input of a temperature coefficient TC
- Ultrapure water
- Table

Linear Temperature Compensation of Process Medium

If the pH value of the medium changes in linear fashion with the temperature, the temperature coefficient TC can be determined for temperature compensation in %/K as follows:

$$TC = (pH_{25} - pH_T) \times 100 / (25 \text{ °C} - T) \text{ [%/K]}$$

TC	Temperature coefficient [%/K]
pH ₂₅	pH value at 25 °C
pH _T	pH value at measuring temperature T
T	Measuring temperature [°C]

Table

When using process media with a known temperature behavior of the pH value, the pH output value can be corrected with a table. The percentage deviation from the measured value in % can be entered for temperatures between 0 and 95 °C in increments of 5 °C. The pH output value is then corrected by the corresponding percentage deviation from the measured value in %, depending on the measuring temperature. Table values are linearly interpolated. If the temperature falls below or exceeds the specified value (< 0 °C or > 95 °C), the last value in the table is used for calculation.

Complete the table with the following values in increments of 5 °C:

$$((pH_{25} / pH_T) - 1) \times 100 \text{ [%]}$$

pH ₂₅	pH value at 25 °C
pH _T	pH value at measuring temperature T

The settings are made in the **TC Process Medium** submenu:

Parameter Setting ▶ [I] [II] ... pH ▶ TC Process Medium

Note: If the delta function and TC correction are enabled at the same time, the TC correction is carried out first and the delta value is then deducted.

6.8.4 Delta Function

Note: If the delta function is enabled, "Δ" is shown on the display in measuring mode.

If a delta value is specified, the measuring system calculates the difference
output value = measured value – delta value

The delta value can be set using the "+" or "-" signs. If using a negative sign, the delta value is added to the measured value.

The delta value is adjusted in the **Delta Function** submenu:

Parameter Setting ▶ [I] [II] [Sensor] ▶ Delta Function

All outputs are controlled by the output value; the displays show the output value.

Note: If the delta function and TC correction are enabled at the same time, the TC correction is carried out first and the delta value is then deducted.

6.8.5 Messages

All values determined by the measuring module or sensor can generate messages.

Messages can be configured for the following process variables:

- pH Value
- ORP (with pH/ORP sensor)
- rH value (with pH/ORP sensor)
- Temperature
- pH Voltage

Setting Parameters for Messages

Individual process variable limits for the monitoring range can be selected in the **Messages** submenu:



Parameter Setting ▶ [I] [II] [Sensor] ▶ Messages ▶ Messages [Process Variable] ▶ Monitoring

- Max. Device Limits: Messages are generated when the process variable is outside the measuring range. The “failure” or “out of specification” icons are shown; the corresponding relay contact is enabled. The current outputs can signal a 22 mA message (user-defined).
- Variable Limits: Upper and lower limits at which a message is generated can be defined for the “Failure” and “Out of Specification” messages.

Note: If display color NE107 is selected in Parameter Setting (factory setting), measured values are backlit in accordance with their NAMUR color when NAMUR messages are available.

Parameter Setting ▶ General ▶ Display

Displaying Messages

- Switch to the Diagnostics menu if the “Failure” , “Maintenance Required”  or “Out of Specification”  icons are flashing on the display: Menu Selection ▶ Diagnostics ▶ Message List
 - ✓ All active messages are displayed in the **Message List** menu item with the following information: Error number, type (Failure, Maintenance Required, Out of Specification), channel, message text.

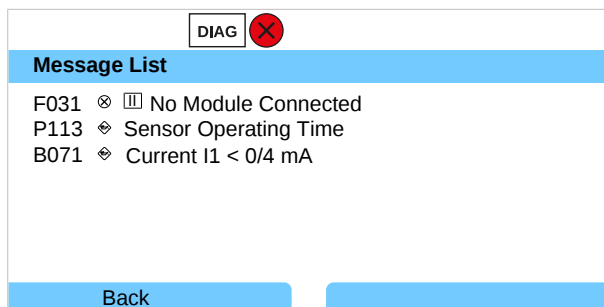

- You can scroll forwards and backwards with the **up/down arrow keys**.

The error message disappears from the display around 2 s after troubleshooting.

You will find an overview of message texts with notes on troubleshooting in the “Troubleshooting” chapter. → *Troubleshooting, p. 154*

6.9 ORP Process Variable

Note: Function check (HOLD) is active.

Note: After changing the process variable or measuring mode, Stratos Multi retains its settings but needs to be reconfigured.

Parameter setting for a Memosens pH/ORP sensor (combo sensor) → *pH Process Variable*, p. 64

Selecting a Memosens ORP Sensor

Parameter Setting ▶ Sensor Selection [I] [II] ▶ Sensor Selection [I]

Selection of a Memosens ORP sensor connected to the RS-485 interface (terminals 1 ... 5):

Process variable: Auto or pH
 Mode: Memosens
 Functionality: ORP

Selecting a Second Memosens ORP Sensor

Parameter Setting ▶ Sensor Selection [I] [II] ▶ Sensor Selection [II]

Selection of a second Memosens ORP sensor connected to the MK-MS095N measuring module:

Module: MK-MS
 Process variable: pH
 Mode: Memosens
 Functionality: ORP

Adjustable parameters for Memosens ORP sensors **Parameter Setting** ▶ **[I] Memosens ORP** :

Submenu	Description
Input Filter	Enable/disable suppression of interference pulses.
Sensor Data → <i>Sensor Data</i> , p. 74	Enable/disable display of Sensoface messages and Sensoface icons. Sensor Monitoring Details Option to enter individual limit values for monitoring ORP offset. Option to enter individual values before a message for sensor operating time and SIP counter is triggered. Tag Description Entry of information about the measuring point and annotations (e.g., date of last maintenance)
Cal Presettings	Presetting of the calibration mode, configuration of the calibration timer and ORP check. → <i>Calibration Presettings</i> , p. 75
ORP / rH Value	Selection of the reference electrode: Ag/AgCl, KCl 1 mol, Ag/AgCl, KCl 3 mol, Hg,Tl/TlCl, KCl 3.5 mol, Hg/Hg ₂ SO ₄ , K ₂ SO ₄ sat. Enable/disable ORP conversion to standard hydrogen electrode SHE. If using a pH sensor connected via a module at the same time, calculate rH with or without factor.
Delta Function	Display deviations from a preset value (delta value): Output value = measured value – delta value → <i>Delta Function</i> , p. 75
Messages	Enable/disable messages for individual process variables or specify individual limit values. → <i>Messages</i> , p. 76

Selecting an Analog ORP Sensor

Parameter Setting ▶ Sensor Selection [I] [II] ▶ Sensor Selection [II]

Selection of an ORP sensor connected to the MK-PH015N measuring module:

Module: MK-PH
 Mode: Analog

When using an analog ORP sensor, the menus are the same as for an analog pH sensor:

Parameter Setting ▶ [II] Analog pH

6.9.1 Sensor Data

Memosens sensors provide relevant sensor data automatically.

Sensoface

The Sensoface icons provide users with diagnostic information on the wear and required maintenance of the sensor. In measuring mode, an icon (happy, neutral, or sad smiley) is shown on the display to reflect the continuous monitoring of the sensor parameters.

You can set the current output parameters such that a Sensoface message generates a 22 mA error signal.

Parameter Setting ▶ Inputs/Outputs ▶ Current Outputs ▶ Current Output I... ▶ Behavior during Messages

Sensoface messages can also be output via a relay contact:

Parameter Setting ▶ Inputs/Outputs ▶ Relay Contacts ▶ Contact K... ▶ Usage → Usage: Sensoface, p. 62

If **Sensoface** is selected, the Sensoface messages of all channels are output via the selected contact.

If **Sensoface (Channel)** is selected, you can output the Sensoface messages of a specific channel via the selected contact.

Enabling/Disabling Sensoface



Sensoface is enabled and disabled in the **Sensor Data** submenu:

Parameter Setting ▶ [I] [II] [Sensor] ▶ Sensor Data

Note: After a calibration, a smiley is always displayed for confirmation, even if Sensoface is disabled.

Adjusting Sensor Monitoring

01. **Sensor Data** ▶ **Sensor Monitoring Details**
02. Open a sensor parameter, e.g., **ORP Offset**.
03. Set **Monitoring** the ORP offset to automatic or individual.
04. If you select "Individual": The nominal ORP offset and the min./max. limit values can be entered.
05. In the **Message** menu item, select whether and how off-limit values should be displayed:

Off	No message.
Failure	A failure message is shown for off-limit conditions; the corresponding NAMUR icon  is displayed. If "Display Color NE107" is set, the measurement display is shown with red backlighting.
Maintenance	A maintenance required message is shown in off-limit conditions; the corresponding NAMUR icon  is displayed. If "Display Color NE107" is set, the measurement display is shown with blue backlighting.
06. Set the sensor monitoring details for additional sensor data like sensor operating time or SIP counter.
07. With **left softkey: Back**, apply the sensor monitoring settings and set additional parameters.
Or
With the **right softkey: Back to Meas.**, confirm the sensor monitoring settings and end the function check (HOLD).

6.9.2 Calibration Presettings

The calibration presettings can be defined in the parameter settings or adjusted directly in the Calibration menu prior to the calibration.

Calibration Mode : Presetting of calibration mode, e.g., ORP Data Entry, ORP Adjustment, ORP Check, Temperature

Calibration timer : When a preset calibration interval elapses, the calibration timer generates a message text to indicate that calibration is required. If "Auto" is selected, the interval is set to 168 h. If "Individual" is selected, a customized interval can be specified.

Note: If Sensoface is enabled, a neutral smiley is displayed once 80 % of the interval has expired. Once the entire interval has expired, a sad smiley is shown, a Maintenance Required message is generated, and the corresponding NAMUR icon is displayed and the measurement display is shown with blue backlighting (display color: NE107). NE107). If the current outputs have the correct parameter setting, a 22 mA error signal is generated.

ORP check : Settings for test period in seconds and test difference in millivolts

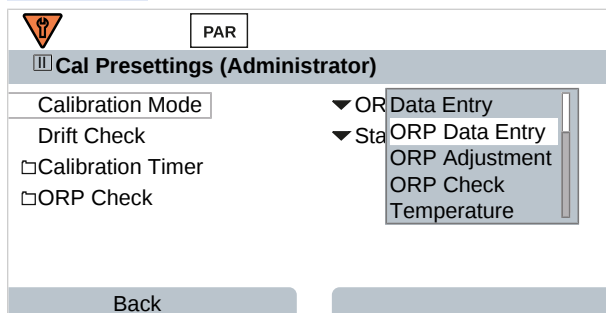

The settings are made in the **Cal Presettings** submenu:

Parameter Setting ▶ [I] [II] [Sensor] ▶ **Cal Presettings**

6.9.3 Delta Function

Note: If the delta function is enabled, "Δ" is shown on the display in measuring mode.

If a delta value is specified, the measuring system calculates the difference
 output value = measured value – delta value

The delta value can be set using the "+" or "-" signs. If using a negative sign, the delta value is added to the measured value.

The delta value is adjusted in the **Delta Function** submenu:

Parameter Setting ▶ [I] [II] [Sensor] ▶ **Delta Function**

All outputs are controlled by the output value; the displays show the output value.

Note: If the delta function and TC correction are enabled at the same time, the TC correction is carried out first and the delta value is then deducted.

6.9.4 Messages

All values determined by the measuring module or sensor can generate messages.

Messages can be configured for the following process variables:

- ORP voltage
- Temperature

Setting Parameters for Messages

Individual process variable limits for the monitoring range can be selected in the **Messages** submenu:



Parameter Setting ▶ [I] [II] [Sensor] ▶ Messages ▶ Messages [Process Variable] ▶ Monitoring

- Max. Device Limits: Messages are generated when the process variable is outside the measuring range. The “failure” or “out of specification” icons are shown; the corresponding relay contact is enabled. The current outputs can signal a 22 mA message (user-defined).
- Variable Limits: Upper and lower limits at which a message is generated can be defined for the “Failure” and “Out of Specification” messages.

Note: If display color NE107 is selected in Parameter Setting (factory setting), measured values are backlit in accordance with their NAMUR color when NAMUR messages are available.

Parameter Setting ▶ General ▶ Display

Displaying Messages

01. Switch to the Diagnostics menu if the “Failure” , “Maintenance Required”  or “Out of Specification”  icons are flashing on the display: Menu Selection ▶ Diagnostics ▶ Message List

- ✓ All active messages are displayed in the **Message List** menu item with the following information: Error number, type (Failure, Maintenance Required, Out of Specification), channel, message text.

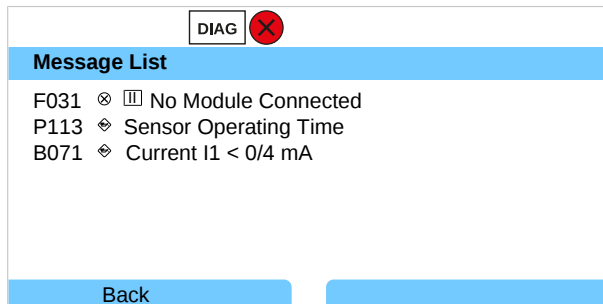

02. You can scroll forwards and backwards with the **up/down arrow keys**.

The error message disappears from the display around 2 s after troubleshooting.

You will find an overview of message texts with notes on troubleshooting in the “Troubleshooting” chapter. → *Troubleshooting, p. 154*

6.10 Conductivity (Contacting) Process Variable

Note: Function check (HOLD) is active.

Note: After changing the process variable or measuring mode, Stratos Multi retains its settings but needs to be reconfigured.

Selecting a Memosens Conductivity Sensor

Parameter Setting ▶ Sensor Selection [I] [II] ▶ Sensor Selection [I]

Selection of a Memosens conductivity sensor connected to the RS-485 interface (terminals 1 ... 5):

Process variable: Auto or conductivity
 Mode: Memosens
 Functionality: 2-electrode sensor or 4-electrode sensor (depending on sensor type)

Selecting a Second Memosens Conductivity Sensor

Parameter Setting ▶ Sensor Selection [I] [II] ▶ Sensor Selection [II]

Selection of a second Memosens conductivity sensor connected to the MK-MS095N measuring module:

Module: MK-MS
 Process variable: Conductivity
 Mode: Memosens
 Functionality: 2-electrode sensor or 4-electrode sensor (depending on sensor type)

Adjustable parameters for Memosens pH conductivity sensor

Parameter Setting ▶ [I] [II] Memosens Cond :

Submenu	Description
Input Filter	Set parameters for suppression of interference pulses. → <i>Input Filter, p. 78</i>
Sensor Data → <i>Sensor Data, p. 80</i>	Enable/disable display of Sensoface messages and Sensoface icons. Sensor Monitoring Details Option to enter individual limit values for monitoring cell constants. Disable Sensocheck sensor monitoring or select whether Sensocheck should generate failure or maintenance required messages. Option to enter individual limits before a message for SIP counter, CIP counter, and sensor operating time is triggered.
	Meas. Point Description Entry of information about the measuring point and annotations (e.g., date of last maintenance)
Cal Presettings	Presetting of calibration mode with corresponding parameters. → <i>Calibration Presettings, p. 82</i>
TC Process Medium	→ <i>Temperature Compensation of Process Medium, p. 83</i>
Concentration	→ <i>Concentration (TAN Option FW-E009), p. 83</i>
TDS	Enable/disable the TDS function → <i>TDS Function, p. 83</i>
USP	Enable/disable USP function for monitoring ultrapure water and set the USP limit value. → <i>USP Function, p. 84</i>
Messages	Enable/disable messages for individual process variables or specify individual limit values. → <i>Messages, p. 85</i>

Selecting an Analog Conductivity Sensor

Parameter Setting ▶ Sensor Selection [I] [II] ▶ Sensor Selection [II]

Selection of a conductivity sensor connected to the MK-COND025N measuring module:

Module: MK-COND
 Mode: Analog

Adjustable parameters for analog conductivity sensors [Parameter Setting ▶ \[II\] Analog Cond :](#)

Submenu	Description
Input Filter	Set parameters for suppression of interference pulses. → <i>Input Filter, p. 78</i>
Sensor Data → <i>Sensor Data, p. 80</i>	Sensor Type Select the sensor type used: 2-electrode sensor, 4-electrode sensor, SE600, SE602, SE603, SE604, SE610, SE620, SE630.
	Nominal Cell Constant Enter if 2-electrode sensor or 4-electrode sensor is selected.
	Sensoface Enable/disable display of Sensoface messages and Sensoface icons.
	Sensochek Disable or select whether Sensochek should generate failure or maintenance required messages.
	Temperature Detection Set measuring and calibration temperature. If 2-electrode sensor or 4-electrode sensor is selected: Select the temperature detector.
Cal Presettings	Presetting of calibration mode with corresponding parameters. → <i>Calibration Presettings, p. 82</i>
TC Process Medium	→ <i>Temperature Compensation of Process Medium, p. 83</i>
Concentration	→ <i>Concentration (TAN Option FW-E009), p. 83</i>
TDS	Enable/disable the TDS function → <i>TDS Function, p. 83</i>
USP	Enable/disable USP function for monitoring ultrapure water and set the USP limit value. → <i>USP Function, p. 84</i>
Messages	Enable/disable messages for individual process variables or specify individual limit values. → <i>Messages, p. 85</i>

6.10.1 Input Filter

Selection of the filter behavior:

Parameter Setting ▶ Administrator Level ▶ [I] [II] ... Cond ▶ Input Filter ▶ Filter

Selection	Description	Use
Off	The measured value is not filtered.	If there are no faults at the sensor due to the medium (e.g., due to gas bubbles, contamination, short-term temperature fluctuations).
Noise Suppression	Only individual measured value outliers are discarded.	If transients are present for < 1 s.
Mean Value	The mean value is calculated using the measured values within the set filter time. Filter time range: 2 ... 30 s	If there are no faults at the sensor and the mean measured value over the set filter period is required.
Smart	The dynamic filter automatically adjusts to the measuring signal. Small fluctuations are stabilized very well. Measured value faults are discarded via the set filter time. A larger jump in measured value will be delayed by the set filter time. Filter time range: 2 ... 30 s	If there are transients at the sensor over the set filter period and they should not distort the measured value, e.g., for gas bubbles in the liquid flow.

An additional time range must only be specified for the “Mean Value” and “Smart” selections:

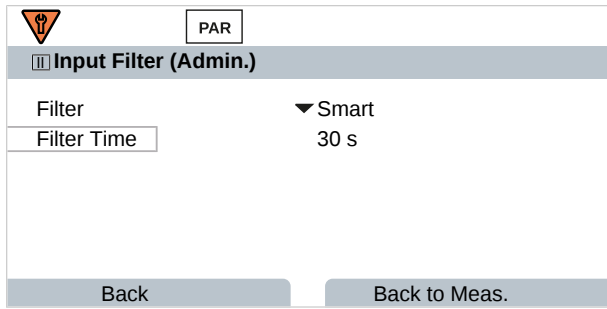
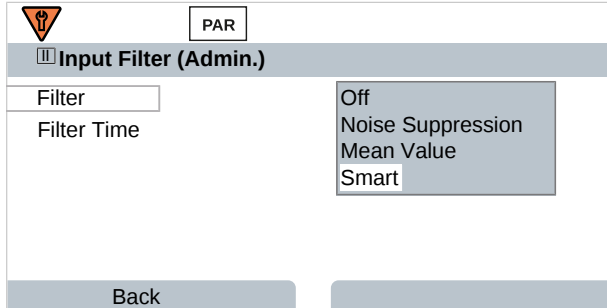

Example of filter behavior with the “Smart” and “Filter time 30 s” settings:

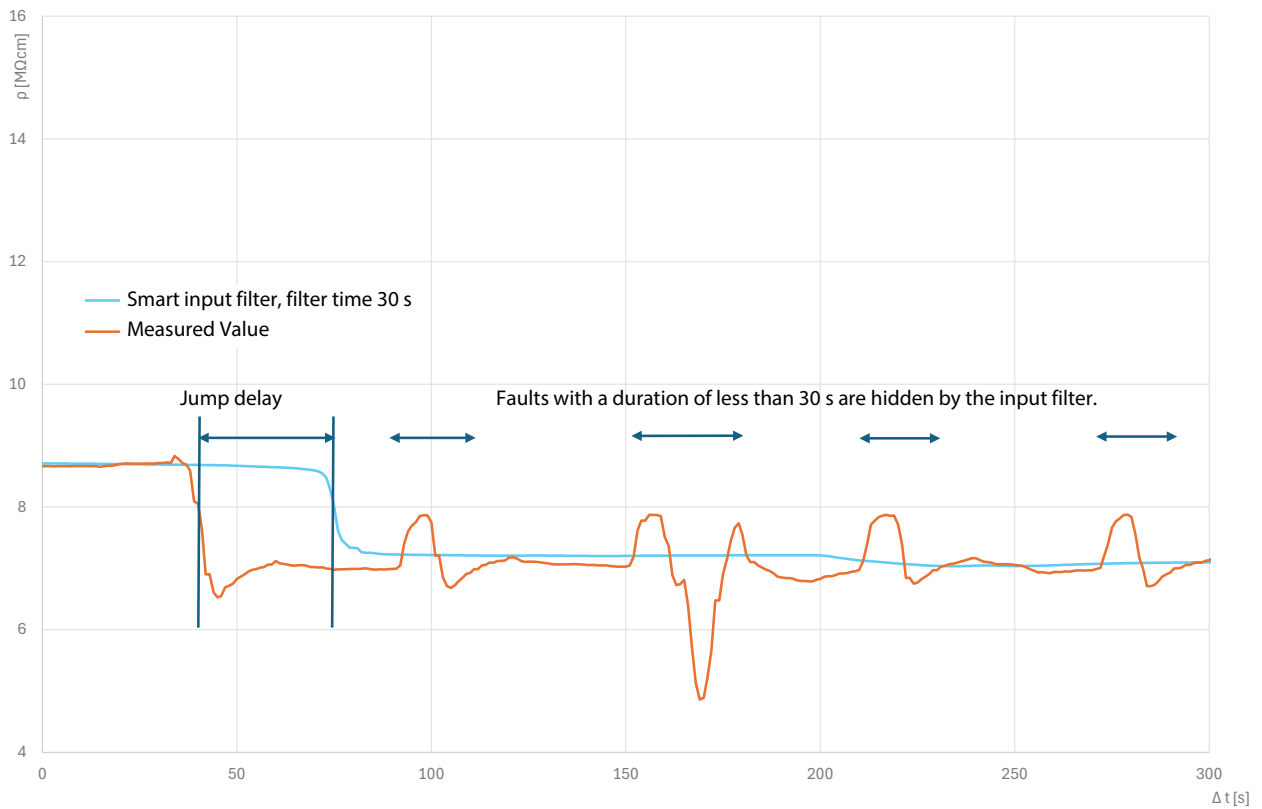

6.10.2 Sensor Data

Memosens sensors provide relevant sensor data automatically.

The sensor type must be selected if using analog sensors:

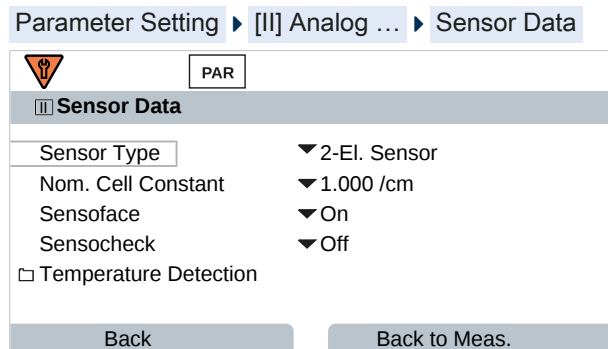

01. Select the **Sensor Type**.
02. Enter the sensor's nominal cell constant.
03. In **Temperature Detection**, select the used temperature probe and whether the temperature is to be measured automatically or manually during measurement and/or calibration.

Sensoface

The Sensoface icons provide users with diagnostic information on the wear and required maintenance of the sensor. In measuring mode, an icon (happy, neutral, or sad smiley) is shown on the display to reflect the continuous monitoring of the sensor parameters.

You can set the current output parameters such that a Sensoface message generates a 22 mA error signal.

Parameter Setting > Inputs/Outputs > Current Outputs > Current Output I... > Behavior during Messages

Sensoface messages can also be output via a relay contact:

Parameter Setting > Inputs/Outputs > Relay Contacts > Contact K... > Usage → Usage: Sensoface, p. 62

If **Sensoface** is selected, the Sensoface messages of all channels are output via the selected contact.

If **Sensoface (Channel)** is selected, you can output the Sensoface messages of a specific channel via the selected contact.

Sensoface monitors the conductivity sensor based on the following parameters:

Cell constant, polarization (if Sensochekc is enabled)

For Memosens sensors, also: Number of CIP and SIP cycles compared to the "Sensor Monitoring Details" specification.

Enabling/Disabling Sensoface



Sensoface is enabled and disabled in the **Sensor Data** submenu:

Parameter Setting > [I] [II] [Sensor] > Sensor Data

Note: After a calibration, a smiley is always displayed for confirmation, even if Sensoface is disabled.

Adjusting Sensor Monitoring

01. Sensor Data ▶ Sensor Monitoring Details
02. Open a sensor parameter, e.g., Cell Constant .
03. Set cell constant Monitoring to automatic or individual.
04. If you select "Individual": The nominal cell constant and the min./max. limit values can be entered.
05. In the Message menu item, select whether and how off-limit values should be displayed:

Off	No message.
Failure	A failure message is shown for off-limit conditions; the corresponding NAMUR icon  is displayed. If "Display Color NE107" is set, the measurement display is shown with red backlighting.
Maintenance	A maintenance required message is shown in off-limit conditions; the corresponding NAMUR icon  is displayed. If "Display Color NE107" is set, the measurement display is shown with blue backlighting.
06. Set the sensor monitoring details for additional sensor data, e.g., Sensocheck, sensor operating time or SIP counter.
07. With **left softkey: Back**, apply the sensor monitoring settings and set additional parameters.
Or
With the **right softkey: Back to Meas.**, confirm the sensor monitoring settings and end the function check (HOLD).

CIP/SIP Counters

CIP/SIP counters are available for the following conductivity sensor types:

- Memosens 2-electrode/4-electrode sensors

CIP/SIP cycles are used to clean or sterilize wetted parts in the process. Depending on the application, either one chemical (alkaline solution, water) or multiple chemicals (alkaline solution, water, acidic solution, water) are used.

- CIP temperature > 55 °C/131 °F
- SIP temperature > 115 °C/239 °F

When a sensor is installed, cleaning (cleaning in place) and sterilization (sterilization in place) cycles are counted to measure the load on the sensor, e.g., in biotechnology applications.

Note: If measurements are generally taken at high temperatures (> 55 °C/131 °F), the counters should be switched off.

When a CIP/SIP counter is enabled, a maximum number of cycles can be entered. A message can be used to signal that the specified counter status is reached.

Note: A CIP or SIP cycle is only entered into the logbook 2 hours after the start to ensure that the cycle is complete.

Note: With Memosens sensors, an entry is also made in the sensor.

Setting CIP/SIP Counters

01. Sensor Monitoring Details ▶ CIP Counter / SIP Counter
02. Monitoring : "Off" or "Individual"
03. If you select "Individual": Enter the maximum number of CIP/SIP cycles.
04. In the Message menu item, select whether and how off-limit values should be displayed:
 - Off No message.
 - Failure A failure message is shown for off-limit conditions; the corresponding NAMUR icon is displayed. If "Display Color NE107" is set, the measurement display is shown with red backlighting.
 - Maintenance A maintenance required message is shown in off-limit conditions; the corresponding NAMUR icon is displayed. If "Display Color NE107" is set, the measurement display is shown with blue backlighting.

6.10.3 Calibration Presettings

The calibration presettings can be defined in the parameter settings or adjusted directly in the Calibration menu prior to the calibration.

Calibration Mode: Presetting of calibration mode, e.g., Automatic, Manual, Product Calibration, Data Entry, Temperature

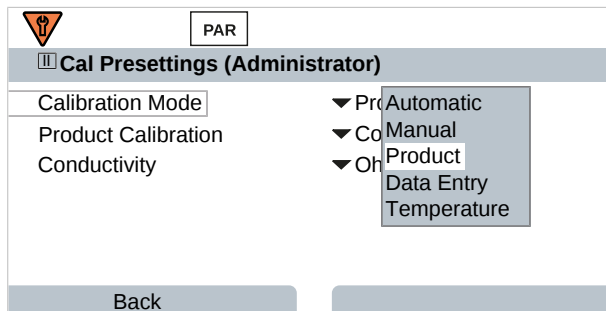

More options are available depending on the calibration mode.

Automatic	Product calibration	
Selection of the calibration solution	Conductivity:	Selection: with/without temperature compensation
	Concentration: ¹⁾	Selection of the medium

Presetting of calibration in the Cal Presettings menu item:

Parameter Setting ▶ [I] [II] ... Cond ▶ Cal Presettings

¹⁾ First enable TAN option FW-E009. → Concentration Determination (FW-E009), p. 187

6.10.4 Temperature Compensation of Process Medium

Note: If temperature compensation of the process medium is enabled, "TC" is shown on the display in measuring mode.

The following selection is available for temperature compensation:

- Off
- Linear (entry of temperature coefficient TC)
- EN 27888 (natural water)
- Ultrapure water (with different trace impurities)

Trace Impurities in Ultrapure Water

NaCl	Neutral ultrapure water, for conductivity measurement in water treatment downstream of gravel bed filter
HCl	Acidic ultrapure water, for conductivity measurement downstream of cation filter
NH ₃	Ammoniacal ultrapure water
NaOH	Alkaline ultrapure water

The settings are made in the **TC Process Medium** submenu:

Parameter Setting ▶ [I] [II] ... Cond(I) ▶ **TC Process Medium**

6.10.5 Concentration (TAN Option FW-E009)

With TAN option FW-E009, the substance concentration in percent by weight (wt%) can be determined for H₂SO₄, H₂SO₄, HNO₃, HCl, NaOH, NaCl, and Oleum from the measured conductivity and temperature values. A custom solution can also be specified.

The menu is only shown if the TAN option is activated.

Parameter Setting ▶ [I] [II] ... Cond(I) ▶ **Concentration**

See also

→ *Concentration Determination (FW-E009), p. 187*

6.10.6 TDS Function

TDS (total dissolved solids) = weight of dissolved solids that influence conductivity

The TDS function provides a quick way of determining the evaporation residue of water. A TDS factor must be entered for this purpose.

The factor establishes a simple linear relationship between measured conductivity and evaporation residue. It is dependent on the composition of the medium and must be empirically determined by the user.

6.10.7 USP Function

Monitoring Ultrapure Water in the Pharmaceutical Industry

The conductivity of ultrapure water in the pharmaceutical industry can be monitored online in accordance with the "USP" (U.S. Pharmacopeia) guideline, Appendix 5, Section 645 "Water Conductivity". Conductivity is measured without temperature compensation and is compared to limit values. The water can be used without further testing if the conductivity is below the USP limit value.

Setting the USP Function Parameters



The USP value can be configured as a process variable USP% for output (display, current output, limit value, measurement recorder)

The settings are made in the **USP** submenu:

Parameter Setting ▶ [I] [II] ... Cond(I) ▶ USP

Reduced Limit Value: The USP limit value can be reduced to as low as 10 %.

Monitoring: Select whether and how off-limit values should be displayed.

Off	No message, but the parameter is still shown in the Diagnostics menu.
Failure	A failure message is shown for off-limit conditions; the corresponding NAMUR icon  is displayed. If "Display Color NE107" is set, the measurement display is shown with red backlighting.
Maintenance	A maintenance required message is shown in off-limit conditions; the corresponding NAMUR icon  is displayed. If "Display Color NE107" is set, the measurement display is shown with blue backlighting.

USP Function: Specifying a Relay Contact

The USP function can also be assigned to a relay contact.

Parameter Setting ▶ Inputs/Outputs ▶ Relay Contacts ▶ Contact K... → Usage: USP Output, p. 61

Displaying the USP Function in the Diagnostics Menu

Diagnostics ▶ [I] [II] ... Cond(I) ▶ USP Function

The USP limit value, the reduced limit value and conductivity are displayed.

6.10.8 Messages

All values determined by the measuring module or sensor can generate messages.

Message parameters can be set for the following process variables:

- Conductivity
- Resistivity
- Concentration (with TAN option FW-E009)
- Temperature
- Salinity

Setting Parameters for Messages

Individual process variable limits for the monitoring range can be selected in the **Messages** submenu:



Parameter Setting ▶ [I] [II] [Sensor] ▶ Messages ▶ Messages [Process Variable] ▶ Monitoring

- Max. Device Limits: Messages are generated when the process variable is outside the measuring range. The “failure” or “out of specification” icons are shown; the corresponding relay contact is enabled. The current outputs can signal a 22 mA message (user-defined).
- Variable Limits: Upper and lower limits at which a message is generated can be defined for the “Failure” and “Out of Specification” messages.

Note: If display color NE107 is selected in Parameter Setting (factory setting), measured values are backlit in accordance with their NAMUR color when NAMUR messages are available.

Parameter Setting ▶ General ▶ Display

Displaying Messages

- Switch to the Diagnostics menu if the “Failure” , “Maintenance Required”  or “Out of Specification”  icons are flashing on the display: Menu Selection ▶ Diagnostics ▶ Message List
 - ✓ All active messages are displayed in the **Message List** menu item with the following information: Error number, type (Failure, Maintenance Required, Out of Specification), channel, message text.

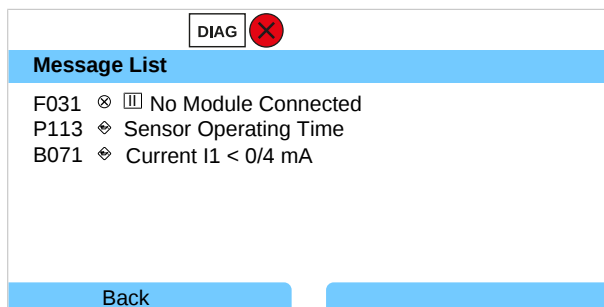

- You can scroll forwards and backwards with the **up/down arrow keys**.

The error message disappears from the display around 2 s after troubleshooting.

You will find an overview of message texts with notes on troubleshooting in the “Troubleshooting” chapter. → *Troubleshooting, p. 154*

6.11 Conductivity (Inductive) Process Variable

Note: Function check (HOLD) is active.

Note: After changing the process variable or measuring mode, Stratos Multi retains its settings but needs to be reconfigured.

Selecting a Digital Toroidal Conductivity Sensor

Parameter Setting ▶ Sensor Selection [I] [II] ▶ Sensor Selection [I]

Selection of a Memosens toroidal conductivity sensor connected to the RS-485 interface (terminals 1 ... 5):

Process variable: Auto or conductivity (induct.)
 Mode: Memosens
 Functionality: Condl

Selection of an SE670/SE680K toroidal digital conductivity sensor connected to the RS-485 interface (terminals 1 ... 5):

Process variable: Conductivity (Induct.)
 Mode: Other Digital
 Functionality: SE670/SE680K

Selecting a Second Digital Toroidal Conductivity Sensor

Parameter Setting ▶ Sensor Selection [I] [II] ▶ Sensor Selection [II]

Selection of a second Memosens conductivity sensor connected to the MK-MS095N measuring module:

Module: MK-MS
 Process variable: Conductivity (Induct.)
 Mode: Memosens
 Functionality: Condl

Selection of a second SE670/SE680K digital toroidal conductivity sensor connected to the MK-MS095N measuring module:

Module: MK-MS
 Process variable: Conductivity (Induct.)
 Mode: Other Digital

Adjustable Parameters for Digital or Memosens Sensors for Inductive Conductivity

Parameter Setting ▶ [I] [II] Digital/Memosens Condi :

Submenu	Description
Input Filter	Enable/disable suppression of interference pulses.
Sensor Data → <i>Sensor Data, p. 88</i>	Enable/disable display of the Sensoface icon. If "Other Digital" is selected:
Sensocheck	Monitoring the primary and secondary coils. Disable or select whether Sensocheck should generate failure or maintenance required messages.
	If "Memosens" is selected:
Sensor Monitoring Details	Option to enter individual limit values for monitoring the cell factor. Sensocheck: Monitoring the primary and secondary coils. Disable or select whether Sensocheck should generate failure or maintenance required messages. Option to enter individual values until a message for SIP counter and sensor operating time is triggered.
Meas. Point Description	Entry of information about the measuring point and annotations (e.g., date of last maintenance)
Cal Presettings	Presetting of calibration mode with corresponding parameters. → <i>Calibration Presettings, p. 90</i>
TC Process Medium	→ <i>Temperature Compensation of Process Medium, p. 90</i>
Concentration	→ <i>Concentration (TAN Option FW-E009), p. 91</i>
TDS	Enable/disable the TDS function. → <i>TDS Function, p. 91</i>
USP	Enable/disable USP function for monitoring ultrapure water and set the USP limit value. → <i>USP Function, p. 91</i>
Messages	Enable/disable messages for individual process variables or specify individual limit values. → <i>Messages, p. 92</i>

Selecting an Analog Toroidal Conductivity Sensor

Parameter Setting ▶ Sensor Selection [I] [II] ▶ Sensor Selection [II]

Selection of a toroidal conductivity sensor connected to the MK-CONDI035N measuring module:

Module: MK-CONDI
Mode: Analog

Adjustable Parameters for Analog Toroidal Conductivity Sensors Parameter Setting ▶ [II] Analog Condi :

Submenu	Description
Input Filter	Enable/disable suppression of interference pulses.
Sensor Data → <i>Sensor Data, p. 88</i>	Sensor Type Select the sensor type used: SE655, SE656, SE660, ISC40, ISC40S, 5000 TC, Other If "Other" is selected, enter additional sensor data.
	Sensoface Enable/disable display of Sensoface messages and Sensoface icons.
	Sensocheck Monitoring the primary and secondary coils. Disable or select whether Sensocheck should generate failure or maintenance required messages.
	Temperature Detection Select temperature detector; set measuring and calibration temperatures.
Cal Presettings	Presetting of calibration mode with corresponding parameters. → <i>Calibration Presettings, p. 90</i>

TC Process Medium	→ <i>Temperature Compensation of Process Medium, p. 90</i>
Concentration	→ <i>Concentration (TAN Option FW-E009), p. 91</i>
TDS	Enable/disable the TDS function. → <i>TDS Function, p. 91</i>
USP	Enable/disable USP function for monitoring ultrapure water and set the USP limit value. → <i>USP Function, p. 91</i>
Messages	Enable/disable messages for individual process variables or specify individual limit values. → <i>Messages, p. 92</i>

6.11.1 Sensor Data

Memosens sensors provide relevant sensor data automatically.

The sensor type must be selected if using analog sensors:

Parameter Setting ▶ [II] Analog ... ▶ Sensor Data

01. Select the **Sensor Type**.
02. Enter the sensor coding, nominal cell factor, and transfer ratio.
03. In **Temperature Detection**, select the used temperature probe and whether the temperature is to be measured automatically or manually during measurement and/or calibration.
Note: The sensor coding for unknown sensor types can be requested from Knick (see the back page of this document for contact details)

Sensoface

The Sensoface icons provide users with diagnostic information on the wear and required maintenance of the sensor. In measuring mode, an icon (happy, neutral, or sad smiley) is shown on the display to reflect the continuous monitoring of the sensor parameters.

You can set the current output parameters such that a Sensoface message generates a 22 mA error signal.

Parameter Setting ▶ Inputs/Outputs ▶ Current Outputs ▶ Current Output I... ▶ Behavior during Messages

Sensoface messages can also be output via a relay contact:

Parameter Setting ▶ Inputs/Outputs ▶ Relay Contacts ▶ Contact K... ▶ Usage → *Usage: Sensoface, p. 62*

If **Sensoface** is selected, the Sensoface messages of all channels are output via the selected contact.

If **Sensoface (Channel)** is selected, you can output the Sensoface messages of a specific channel via the selected contact.

Sensoface monitors the toroidal conductivity sensor based on the following parameters: Cell factor, zero point, and when Sensocheck is activated: Primary/secondary coil and cables. Additionally for Memosens sensors: Number of SIP cycles in comparison to the "Sensor Monitoring Details" specification.

Enabling/Disabling Sensoface



Sensoface is enabled and disabled in the **Sensor Data** submenu:

Parameter Setting ▶ **[I] [II] [Sensor]** ▶ **Sensor Data**

Note: After a calibration, a smiley is always displayed for confirmation, even if Sensoface is disabled.

Adjusting Sensor Monitoring

01. **Sensor Data** ▶ **Sensor Monitoring Details**
02. Open a sensor parameter, e.g., **Cell Constant**.
03. Set cell constant **Monitoring** to automatic or individual.
04. If you select "Individual": The nominal cell constant and the min./max. limit values can be entered.
05. In the **Message** menu item, select whether and how off-limit values should be displayed:

Off	No message.
Failure	A failure message is shown for off-limit conditions; the corresponding NAMUR icon  is displayed. If "Display Color NE107" is set, the measurement display is shown with red backlighting.
Maintenance	A maintenance required message is shown in off-limit conditions; the corresponding NAMUR icon  is displayed. If "Display Color NE107" is set, the measurement display is shown with blue backlighting.
06. Set the sensor monitoring details for additional sensor data, e.g., Sensocheck, sensor operating time or SIP counter.
07. With **left softkey: Back**, apply the sensor monitoring settings and set additional parameters.
Or
With the **right softkey: Back to Meas.**, confirm the sensor monitoring settings and end the function check (HOLD).

SIP Counters

SIP counters are available for the following conductivity sensor types:

- Inductive Memosens conductivity sensors

SIP cycles are used to sterilize wetted parts in the process. Depending on the application, either one chemical (alkaline solution, water) or multiple chemicals (alkaline solution, water, acidic solution, water) are used.

- SIP temperature > 115 °C/239 °F

When a sensor is installed, sterilization (sterilization in place) cycles are counted to measure the load on the sensor, e.g., in biotechnology applications.

Note: If measurements are generally taken at high temperatures (> 55 °C/131 °F), the counters should be switched off.

When a SIP counter is enabled, a maximum number of cycles can be entered. A message can be used to signal that the specified counter status is reached.

Note: A SIP cycle is not entered into the logbook until 2 hours after it started to ensure that the cycle is complete.

Note: With Memosens sensors, an entry is also made in the sensor.

Setting SIP Counters

01. Sensor Monitoring Details ▶ SIP Counter
02. Monitoring : Off or individual
03. If you select "Individual": Enter the maximum number of SIP cycles.
04. In the Message menu item, select whether and how off-limit values should be displayed:

Off	No message.
Failure	A failure message is shown for off-limit conditions; the corresponding NAMUR icon is displayed. If "Display Color NE107" is set, the measurement display is shown with red backlighting.
Maintenance	A maintenance required message is shown in off-limit conditions; the corresponding NAMUR icon is displayed. If "Display Color NE107" is set, the measurement display is shown with blue backlighting.

6.11.2 Calibration Presettings

The calibration presettings can be defined in the parameter settings or adjusted directly in the Calibration menu prior to the calibration.

Calibration Mode: Presetting of calibration mode, e.g., Automatic, Manual, Product Calibration, Zero Point, Installation Factor, Data Entry, Temperature

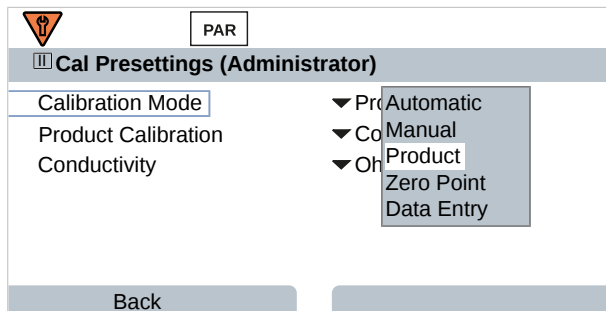

More options are available depending on the calibration mode.

Automatic	Product calibration	
Selection of the calibration solution	Conductivity:	Selection: with/without temperature compensation
	Concentration: ¹⁾	Selection of the medium

Presetting of calibration in the Cal Presettings menu item:

Parameter Setting ▶ [I] [II] ... Condl ▶ Cal Presettings

6.11.3 Temperature Compensation of Process Medium

Note: If temperature compensation of the process medium is enabled, "TC" is shown on the display in measuring mode.

The following selection is available for temperature compensation:

- Off
- Linear (entry of temperature coefficient TC)
- EN 27888 (natural water)
- Ultrapure water (with different trace impurities)

Trace Impurities in Ultrapure Water

NaCl	Neutral ultrapure water, for conductivity measurement in water treatment downstream of gravel bed filter
HCl	Acidic ultrapure water, for conductivity measurement downstream of cation filter
NH ₃	Ammoniacal ultrapure water
NaOH	Alkaline ultrapure water

¹⁾ First enable TAN option FW-E009. → Concentration Determination (FW-E009), p. 187

The settings are made in the **TC Process Medium** submenu:

Parameter Setting ▶ [I] [II] ... Cond(I) ▶ TC Process Medium

6.11.4 Concentration (TAN Option FW-E009)

With TAN option FW-E009, the substance concentration in percent by weight (wt%) can be determined for H₂SO₄, H₂SO₄, HNO₃, HCl, NaOH, NaCl, and Oleum from the measured conductivity and temperature values. A custom solution can also be specified.

The menu is only shown if the TAN option is activated.

Parameter Setting ▶ [I] [II] ... Cond(I) ▶ Concentration

See also

→ *Concentration Determination (FW-E009), p. 187*

6.11.5 TDS Function

TDS (total dissolved solids) = weight of dissolved solids that influence conductivity

The TDS function provides a quick way of determining the evaporation residue of water. A TDS factor must be entered for this purpose.

The factor establishes a simple linear relationship between measured conductivity and evaporation residue. It is dependent on the composition of the medium and must be empirically determined by the user.

6.11.6 USP Function

Monitoring Ultrapure Water in the Pharmaceutical Industry

The conductivity of ultrapure water in the pharmaceutical industry can be monitored online in accordance with the "USP" (U.S. Pharmacopeia) guideline, Appendix 5, Section 645 "Water Conductivity". Conductivity is measured without temperature compensation and is compared to limit values. The water can be used without further testing if the conductivity is below the USP limit value.

Setting the USP Function Parameters



The USP value can be configured as a process variable USP% for output (display, current output, limit value, measurement recorder)

The settings are made in the **USP** submenu:

Parameter Setting ▶ [I] [II] ... Cond(I) ▶ USP

Reduced Limit Value: The USP limit value can be reduced to as low as 10 %.

Monitoring: Select whether and how off-limit values should be displayed.

Off	No message, but the parameter is still shown in the Diagnostics menu.
Failure	A failure message is shown for off-limit conditions; the corresponding NAMUR icon  is displayed. If "Display Color NE107" is set, the measurement display is shown with red backlighting.
Maintenance	A maintenance required message is shown in off-limit conditions; the corresponding NAMUR icon  is displayed. If "Display Color NE107" is set, the measurement display is shown with blue backlighting.

USP Function: Specifying a Relay Contact

The USP function can also be assigned to a relay contact.

Parameter Setting ▶ Inputs/Outputs ▶ Relay Contacts ▶ Contact K... → *Usage: USP Output, p. 61*

Displaying the USP Function in the Diagnostics Menu

Diagnostics ▶ [I] [II] ... Cond(I) ▶ USP Function

The USP limit value, the reduced limit value and conductivity are displayed.

6.11.7 Messages

All values determined by the measuring module or sensor can generate messages.

Message parameters can be set for the following process variables:

- Conductivity
- Resistivity
- Concentration (with TAN option FW-E009)
- Temperature
- Salinity

Setting Parameters for Messages

Individual process variable limits for the monitoring range can be selected in the **Messages** submenu:



Parameter Setting ▶ [I] [II] [Sensor] ▶ Messages ▶ Messages [Process Variable] ▶ Monitoring

- Max. Device Limits: Messages are generated when the process variable is outside the measuring range. The “failure” or “out of specification” icons are shown; the corresponding relay contact is enabled. The current outputs can signal a 22 mA message (user-defined).
- Variable Limits: Upper and lower limits at which a message is generated can be defined for the “Failure” and “Out of Specification” messages.

Note: If display color NE107 is selected in Parameter Setting (factory setting), measured values are backlit in accordance with their NAMUR color when NAMUR messages are available.

Parameter Setting ▶ General ▶ Display

Displaying Messages

- Switch to the Diagnostics menu if the “Failure” , “Maintenance Required”  or “Out of Specification”  icons are flashing on the display: Menu Selection ▶ Diagnostics ▶ Message List
 - ✓ All active messages are displayed in the **Message List** menu item with the following information: Error number, type (Failure, Maintenance Required, Out of Specification), channel, message text.

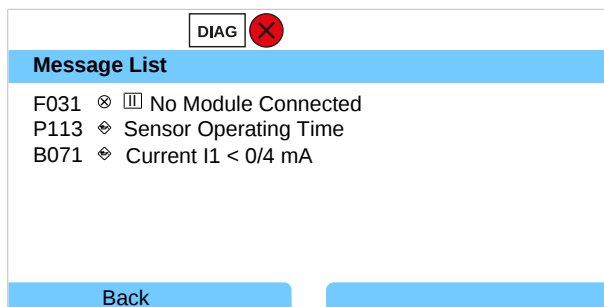

- You can scroll forwards and backwards with the **up/down arrow keys**.

The error message disappears from the display around 2 s after troubleshooting.

You will find an overview of message texts with notes on troubleshooting in the “Troubleshooting” chapter. → *Troubleshooting, p. 154*

6.12 Dual Conductivity Measurement

Analog 2-Channel Conductivity Measurement with the MK-CC065N Measuring Module

The module can operate with two 2-electrode conductivity sensors, each with a Pt1000 temperature probe.

Select the MK-CC065N measuring module:

Parameter Setting ▶ Sensor Selection [I] [II] ▶ Sensor Selection [II]

Module: MK-CC

Mode: Analog

Parameter Setting ▶ [II] Analog Cond-Cond

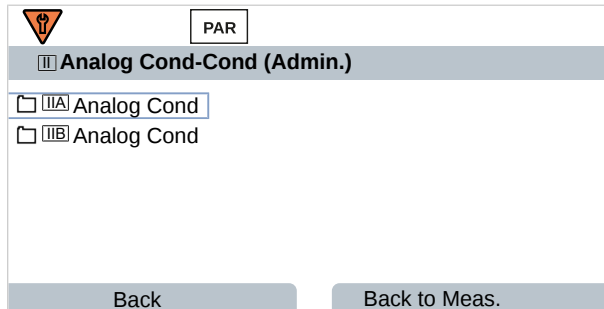

Parameter setting → *Conductivity (Contacting) Process Variable, p. 78*

2-Channel Conductivity Measurement with Memosens

A 2-channel conductivity measurement can also be performed with two Memosens sensors or one Memosens and one analog sensor. In this case, a Memosens sensor is directly connected to the device, a second conductivity sensor via the MK-COND025N or MK-MS095N modules.

Parameter setting → *Conductivity (Contacting) Process Variable, p. 77*

Layout of the Measuring Point

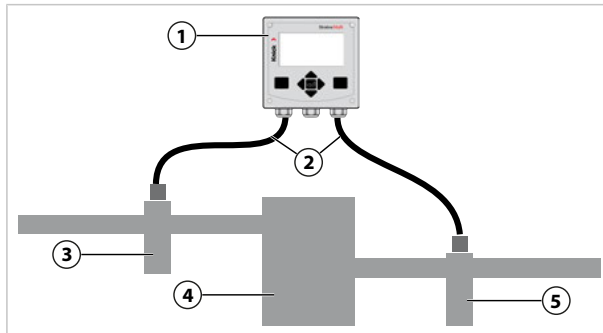

- | | |
|---|--|
| 1 Stratos Multi | 4 Cation exchanger |
| 2 Max. connection length 3 m | 5 Outlet: Conductivity sensor B with fitting |
| 3 Inlet: Conductivity sensor A with fitting | |

Calculation Blocks (TAN Option FW-E020)

With TAN option FW-E020, "Calculation Blocks", the measured conductivity values can be converted into new variables. → *Calculation Blocks (FW-E020), p. 194*

6.13 Oxygen Process Variable

Note: Function check (HOLD) is active.

Note: After changing the process variable or measuring mode, Stratos Multi retains its settings but needs to be reconfigured.

Note: Oxygen measurements in low oxygen concentrations require TAN option FW-E015.

Selecting a Memosens Oxygen Sensor

Parameter Setting ▶ Sensor Selection [I] [II] ▶ Sensor Selection [I]

Selection of the Memosens oxygen sensor connected to the RS-485 interface (terminals 1 ... 5):

Process variable: Auto or oxygen
 Mode: Memosens
 Functionality: Amperometric

Selecting a Second Memosens Oxygen Sensor

Parameter Setting ▶ Sensor Selection [I] [II] ▶ Sensor Selection [II]

Selection of a second Memosens oxygen sensor connected to the MK-MS095N measuring module:

Module: MK-MS
 Process variable: Oxygen
 Mode: Memosens
 Functionality: Amperometric

Adjustable parameters for Memosens oxygen sensors Parameter Setting ▶ [I] [II] Memosens Oxy :

Submenu	Description
Input Filter	Noise Suppression Suppression of interference pulses: Off, weak, medium, strong
	Input Filter Setting in seconds
Sensor Data → <i>Sensor Data, p. 97</i>	Measure in Liquids, gases
	Sensoface Enable/disable display of Sensoface messages and Sensoface icons.
	Sensor Monitoring Details Option to enter individual limit values for monitoring individual parameters. Disable Sensocheck sensor monitoring or select whether Sensocheck should generate failure or maintenance required messages. Option to enter individual limits until a message for settling time, sensor wear, sensor operating time, SIP counter is triggered.
	Meas. Point Description Entry of information about the measuring point and annotations (e.g., date of last maintenance)
Cal Presettings	Presetting of calibration mode and calibration timer. → <i>Calibration Presettings, p. 100</i>
Pressure Correction	Manual input of pressure during measurement and calibration or pressure correction via AO 1. → <i>Pressure Correction, p. 100</i>
Salinity Correction	Salinity, chlorinity, conductivity → <i>Salinity Correction, p. 101</i>
Messages	Enable/disable messages for the individual process variables, or specify individual limit values. → <i>Messages, p. 101</i>

Selecting the SE740 (LDO) Optical Oxygen Sensor

Parameter Setting ▶ Sensor Selection [I] [II] ▶ Sensor Selection [I]

Selection of the SE740 oxygen sensor connected to the RS-485 interface (terminals 1 ... 6):

Process variable: Auto or oxygen

Mode: Other Digital

Functionality: SE740

Note: The voltage at terminal 6 (Power Out) is automatically set to 14 V when the SE740 optical oxygen sensor is used. The Power Out menu item is not available.

Adjustable parameters for the SE740 optical oxygen sensor Parameter Setting ▶ [I] Digital Oxy

Submenu	Description
Input Filter	Noise Suppression Suppression of interference pulses: Off, weak, medium, strong
	Input Filter Setting in seconds
Sensor Data → <i>Sensor Data, p. 97</i>	Measure in Liquids, gases
	Sensoface Enable/disable display of Sensoface messages and Sensoface icons.
	Sensor Monitoring Details Selection of whether a failure or maintenance required message is triggered if the ranges of the Stern-Volmer constant and phase angle are exceeded. Disable Sensocheck sensor monitoring or select whether Sensocheck should generate failure or maintenance required messages. Option to enter individual values until a message for sensor wear, sensor operating time, CIP counter, O ₂ measurement with CIP/SIP, autoclaving counter is triggered.
Cal Presettings	Presetting of calibration mode and calibration timer. → <i>Calibration Presettings, p. 100</i>
Pressure Correction	Manual input of pressure during measurement and calibration or pressure correction via AO 1. → <i>Pressure Correction, p. 100</i>
Salinity Correction	Salinity, chlorinity, conductivity → <i>Salinity Correction, p. 101</i>
Messages	Enable/disable messages for the individual process variables, or specify individual limit values. → <i>Messages, p. 101</i>

Selecting a Digital ISM Oxygen Sensor (TAN Option FW-E053)

Parameter Setting ▶ Sensor Selection [I] [II] ▶ Sensor Selection [II]

Selection of an ISM oxygen sensor connected to the MK-OXY046N measuring module:

Module: MK-OXY
 Mode: ISM

Adjustable parameters for ISM oxygen sensors [Parameter Setting](#) ▶ [\[II\] ISM Oxy](#)

Submenu	Description	
Input Filter	Noise Suppression	Suppression of interference pulses: Off, weak, medium, strong
	Input Filter	Setting in seconds
Sensor Data → <i>Sensor Data, p. 97</i>	Measure in	Liquids, gases
	Sensoface	Enable/disable display of Sensoface messages and Sensoface icons.
	Sensor Monitoring Details	Option to enter individual limit values for monitoring slope, zero point, Sensocheck impedance, settling time, sensor operating time, TTM maintenance timer, DLI Lifetime Indicator, CIP/SIP counters, autoclaving counter, membrane body replacement, interior body replacement. Specify whether to generate a failure or maintenance required message if values are exceeded.
Cal Presettings	Presetting of calibration mode and calibration timer. → <i>Calibration Presettings, p. 100</i>	
Pressure Correction	Manual input of pressure during measurement and calibration or pressure correction via AO 1. → <i>Pressure Correction, p. 100</i>	
Salinity Correction	Salinity, chlorinity, conductivity → <i>Salinity Correction, p. 101</i>	
Messages	Enable/disable messages for the individual process variables, or specify individual limit values. → <i>Messages, p. 101</i>	

Additional information on use of ISM sensors → *Digital ISM-Sensors (FW-E053), p. 198*

Selecting an Analog Oxygen Sensor

Parameter Setting ▶ Sensor Selection [I] [II] ▶ Sensor Selection [II]

Selection of an oxygen sensor connected to the MK-OXY046N measuring module:

Module: MK-OXY
 Mode: Analog

Adjustable parameters for analog oxygen sensors [Parameter Setting](#) ▶ [\[II\] Analog Oxy](#)

Submenu	Description	
Input Filter	Noise Suppression	Suppression of interference pulses: Off, weak, medium, strong
	Input Filter	Setting in seconds
Sensor Data → <i>Sensor Data, p. 97</i>	Measure in	Liquids, gases
	Sensor Type	Standard or other
	Temperature detector	NTC 22 kΩ, NTC 30 kΩ
	Sensor Polarization	Automatic or individual If you select "Individual", you can enter separate values for polarization during measurement and during calibration.
	Membrane compensation	If "Other Sensor Type" is selected
	Sensoface	Enable/disable display of Sensoface messages and Sensoface icons.

Submenu	Description
Sensor Monitoring Details	Option to enter individual limit values for monitoring zero point and slope. Disable Sensocheck sensor monitoring or select whether Sensocheck should generate failure or maintenance required messages. Option to enter individual limits until a message for settling time is triggered.
Cal Presettings	Presetting of calibration mode and calibration timer. → <i>Calibration Presettings, p. 100</i>
Pressure Correction	Manual input of pressure during measurement and calibration or pressure correction via AO 1. → <i>Pressure Correction, p. 100</i>
Salinity Correction	Salinity, chlorinity, conductivity → <i>Salinity Correction, p. 101</i>
Messages	Enable/disable messages for individual process variables or specify individual limit values. → <i>Messages, p. 101</i>

6.13.1 Sensor Data

Display Example for Analog Oxygen Sensor

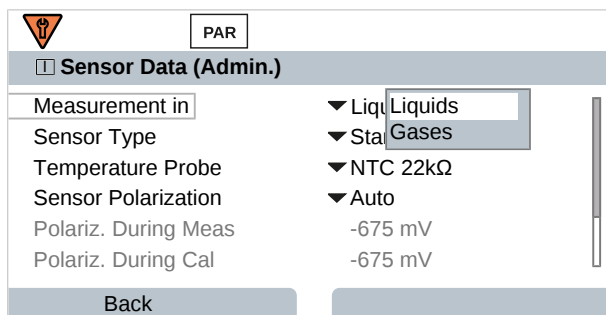

01. Select whether to measure in liquids or gases.
02. If measuring in gases: Enter relative humidity of the process medium.
03. If using an analog sensor: Select sensor type and temperature detector used.
04. If using an analog sensor: Select whether the polarization voltage should be selected automatically or individually during measurement and calibration.

Note: The default polarization voltage of -675 mV is appropriate for most measurements.

The settings are made in the **Sensor Data** submenu:

Parameter Setting ▶ [I] [II] ... Oxy ▶ Sensor Data

Sensoface

The Sensoface icons provide users with diagnostic information on the wear and required maintenance of the sensor. In measuring mode, an icon (happy, neutral, or sad smiley) is shown on the display to reflect the continuous monitoring of the sensor parameters.

You can set the current output parameters such that a Sensoface message generates a 22 mA error signal.

Parameter Setting ▶ Inputs/Outputs ▶ Current Outputs ▶ Current Output I... ▶ Behavior during Messages

Sensoface messages can also be output via a relay contact:

Parameter Setting ▶ Inputs/Outputs ▶ Relay Contacts ▶ Contact K... ▶ Usage → *Usage: Sensoface, p. 62*

If **Sensoface** is selected, the Sensoface messages of all channels are output via the selected contact.

If **Sensoface (Channel)** is selected, you can output the Sensoface messages of a specific channel via the selected contact.

Sensoface monitors the oxygen sensor for slope, zero point, settling time, and sensor wear. Sensoface is displayed if Sensocheck was enabled during parameter setting.

Enabling/Disabling Sensoface

Sensoface is enabled and disabled in the **Sensor Data** submenu:

Parameter Setting ▶ [I] [II] [Sensor] ▶ Sensor Data

Note: After a calibration, a smiley is always displayed for confirmation, even if Sensoface is disabled.

Adjusting Sensor Monitoring

01. **Sensor Data** ▶ **Sensor Monitoring Details**
02. Open a sensor parameter, e.g., **Slope**.
03. Set **Monitoring** of the slope to automatic or individual.
04. If you select "Individual": The nominal slope and the min./max. limit values can be entered.
05. In the **Message** menu item, select whether and how off-limit values should be displayed:

Off	No message, but the parameter is still shown in the Diagnostics menu and on the sensor diagram.
Failure	A failure message is shown for off-limit conditions; the corresponding NAMUR icon is displayed. If "Display Color NE107" is set, the measurement display is shown with red backlighting.
Maintenance	A maintenance required message is shown in off-limit conditions; the corresponding NAMUR icon is displayed. If "Display Color NE107" is set, the measurement display is shown with blue backlighting.
06. Set the sensor monitoring details for other sensor data, e.g., zero point, Sensocheck, settling time, sensor wear, or sensor operating time.
07. With **left softkey: Back**, apply the sensor monitoring settings and set additional parameters.
Or
With the **right softkey: Back to Meas.**, confirm the sensor monitoring settings and end the function check (HOLD).

CIP/SIP Counters

CIP/SIP counters are available for the following oxygen sensor types:

	Memosens Oxy	SE740	ISM Oxy ¹⁾
CIP Counters		+	+
SIP Counters	+		+

CIP/SIP cycles are used to clean or sterilize wetted parts in the process. Depending on the application, either one chemical (alkaline solution, water) or multiple chemicals (alkaline solution, water, acidic solution, water) are used.

- CIP temperature > 55 °C/131 °F
- SIP temperature > 115 °C/239 °F

When a sensor is installed, cleaning (cleaning in place) and sterilization (sterilization in place) cycles are counted to measure the load on the sensor, e.g., in biotechnology applications.

Note: If measurements are generally taken at high temperatures (> 55 °C/131 °F), the counters should be switched off.

¹⁾ With TAN option FW-E053



When a CIP/SIP counter is enabled, a maximum number of cycles can be entered. A message can be used to signal that the specified counter status is reached.

Note: A CIP or SIP cycle is only entered into the logbook 2 hours after the start to ensure that the cycle is complete.

Note: With Memosens sensors, an entry is also made in the sensor.

Setting CIP/SIP Counters



01. Sensor Monitoring Details ▶ CIP Counter / SIP Counter
02. Monitoring : "Off" or "Individual"
03. If you select "Individual": Enter the maximum number of CIP/SIP cycles.
04. In the Message menu item, select whether and how off-limit values should be displayed:

Off	No message.
Failure	A failure message is shown for off-limit conditions; the corresponding NAMUR icon  is displayed. If "Display Color NE107" is set, the measurement display is shown with red backlighting.
Maintenance	A maintenance required message is shown in off-limit conditions; the corresponding NAMUR icon  is displayed. If "Display Color NE107" is set, the measurement display is shown with blue backlighting.

Oxygen Measurement with CIP

When the SE740 optical oxygen sensor is used, the temperature can be monitored during the CIP process. When a set temperature is exceeded, the sensor automatically stops oxygen measurement to extend the service life of the membrane. The measured oxygen value is frozen, the temperature continues to be measured.

01. Sensor Monitoring Details ▶ O2 Meas. with CIP
02. Monitoring : "Automatic" or "Individual"
03. If you select "Individual": Enter the maximum cut-off temperature.
04. In the Message menu item, select whether and how off-limit values should be displayed:

Off	No message, but the parameter is still shown in the Diagnostics menu and on the sensor diagram.
Failure	A failure message is shown for off-limit conditions; the corresponding NAMUR icon  is displayed. If "Display Color NE107" is set, the measurement display is shown with red backlighting.
Maintenance	A maintenance required message is shown in off-limit conditions; the corresponding NAMUR icon  is displayed. If "Display Color NE107" is set, the measurement display is shown with blue backlighting.

Autoclaving Counter

An autoclaving counter is available for the following oxygen sensor types:

- Optical oxygen sensor SE740
- ISM oxygen sensors (with TAN option FW-E053)

Autoclaving cycles are counted to help measure the load on the sensor.

Setting the Autoclaving Counter

01. Sensor Monitoring Details ▶ Autoclaving Counter
02. Monitoring : "Off" or "Individual"
03. If you select "Individual": Enter the maximum number of autoclaving cycles.
04. In the Message menu item, select whether and how off-limit values should be displayed:

Off	No message.
Failure	A failure message is shown for off-limit conditions; the corresponding NAMUR icon is displayed. If "Display Color NE107" is set, the measurement display is shown with red backlighting.
Maintenance	A maintenance required message is shown in off-limit conditions; the corresponding NAMUR icon is displayed. If "Display Color NE107" is set, the measurement display is shown with blue backlighting.

After each autoclaving process, the autoclaving counter must be manually incremented in the Maintenance menu of the device:

Maintenance ▶ [I][II] [Sensor] ▶ Autoclaving Counter

6.13.2 Calibration Presettings

The calibration presettings can be defined in the parameter settings or adjusted directly in the Calibration menu prior to the calibration.

Calibration Mode : Presetting of calibration mode, e.g., In Air, In Water, Data Entry, Product Calibration, Zero Calibration, Temperature

If you select "Product Calibration" calibration mode, you must also select the measured value: Sat. %air, concentration (gas), partial pressure

Calibration Timer : When a preset calibration interval elapses, the calibration timer generates a message text to indicate that calibration is required. If "Auto" is selected, the interval is set to 720 h. If "Individual" is selected, a customized interval can be specified.

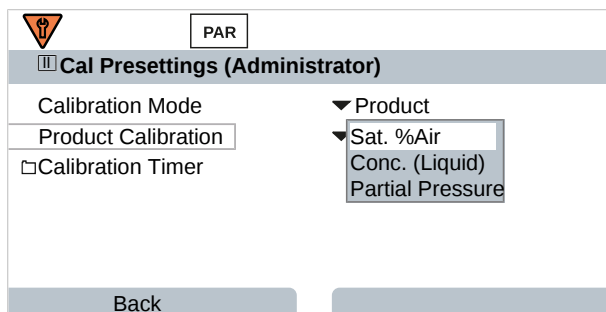

The settings are made in the Cal Presettings submenu:

Parameter Setting ▶ [I] [II] ... Oxy ▶ Cal Presettings

Note: If Sensoface is enabled, a neutral smiley is displayed once 80 % of the interval has expired. Once the entire interval has expired, a sad smiley is shown, a Maintenance Required message is generated, and the corresponding NAMUR icon is displayed and the measurement display is shown with blue backlighting (display color: NE107). NE107). If the current outputs have the correct parameter setting, a 22 mA error signal is generated.

6.13.3 Pressure Correction

The pressure used for measurement or calibration can be manually specified (factory setting 1013 mbar); alternatively, the value of an external pressure transmitter can be provided via Ethernet AO 1 (analog output). → *Connections to the Controller, p. 109*

The settings are made in the Pressure Correction submenu:

Parameter Setting ▶ [I] [II] ... Oxy ▶ Pressure Correction

6.13.4 Salinity Correction

The solubility of oxygen in water depends on its salinity. The correction is made by either directly entering the salinity in g/kg, entering the chlorinity in g/kg, or entering the conductivity in $\mu\text{S}/\text{cm}$ and the temperature.

The settings are made in the **Salinity Correction** submenu:

Parameter Setting ▶ [I] [II] ... Oxy ▶ Salinity Correction

6.13.5 Messages

All values determined by the measuring module or sensor can generate messages.

Message parameters can be set for the following process variables:

- Sat. %Air
- Saturation %O₂
- Concentration
- Partial Pressure
- Temperature
- Process Pressure

Setting Parameters for Messages

Individual process variable limits for the monitoring range can be selected in the **Messages** submenu:



Parameter Setting ▶ [I] [II] [Sensor] ▶ Messages ▶ Messages [Process Variable] ▶ Monitoring

- Max. Device Limits: Messages are generated when the process variable is outside the measuring range. The "failure" or "out of specification" icons are shown; the corresponding relay contact is enabled. The current outputs can signal a 22 mA message (user-defined).
- Variable Limits: Upper and lower limits at which a message is generated can be defined for the "Failure" and "Out of Specification" messages.

Note: If display color NE107 is selected in Parameter Setting (factory setting), measured values are backlit in accordance with their NAMUR color when NAMUR messages are available.

Parameter Setting ▶ General ▶ Display

Displaying Messages

01. Switch to the Diagnostics menu if the "Failure" , "Maintenance Required"  or "Out of Specification"  icons are flashing on the display: Menu Selection ▶ Diagnostics ▶ Message List

- ✓ All active messages are displayed in the **Message List** menu item with the following information: Error number, type (Failure, Maintenance Required, Out of Specification), channel, message text.

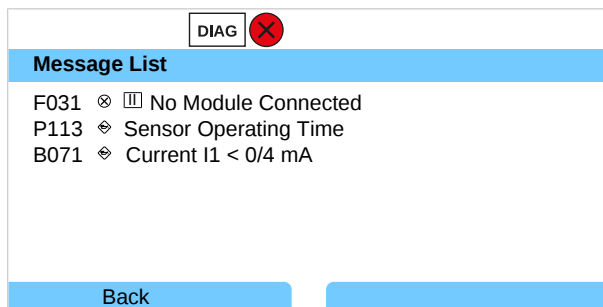

02. You can scroll forwards and backwards with the **up/down arrow keys**.

The error message disappears from the display around 2 s after troubleshooting.

You will find an overview of message texts with notes on troubleshooting in the "Troubleshooting" chapter. → *Troubleshooting, p. 154*

6.14 EtherNet/IP

6.14.1 Configuring the EIP Channel

System Integration

An EtherNet/IP EDS file (electronic data sheet) is required for system integration.

The latest version of the EDS file, "E471N-Vxxxxxx.eds", is available to download from the Knick website.

Network settings

The network settings can be adjusted via the Ethernet interface or via the local operation.

Settings in local operation:

01. Parameter Setting ▶ EtherNet/IP
02. Usage
On: Ethernet interface is enabled
Off: Ethernet interface is disabled
03. IPv4 Address Mode : DHCP or Custom
04. If you select IPv4 address mode "Custom", please also enter the IPv4 address, subnet mask and standard gateway.
If no gateway exists, enter the IPv4 address 0.0.0.0.

EtherNet/IP (Admin.)	
Usage	▼ On
IPv4 Address Mode	▼ Custom
IPv4 Address	192.168.016.010
IPv4 Subnet Mask	255.255.255.000
IPv4 Standard Gateway	000.000.000.000
<input type="checkbox"/> Measured Values	
<div style="display: flex; justify-content: space-between;"> Back Back to Meas. </div>	

6.14.2 Configuration with Studio 5000 Logix Designer®

Importing the EDS

01. Open the EDS Hardware Installation Tool from the TOOLS menu.
02. Confirm the EDS Wizard.
03. Select "Register an EDS".
04. Select the file "E471N-Vxxxxxx.EDS" with the browser button.
05. Confirm the "EDS File Installation Test Results".
06. Confirm the "Graphic Image".
07. Confirm the "Final Task Summary".

Adding a Device to the Project

01. Choose the Ethernet branch. Use the right mouse button to select the entry "New Module" in the context menu.
02. Select the device "Stratos_Multi_E471N" from the device catalog.
03. In the "NewModule/General" section, enter a name of station and configure the IP address.
04. Check the connection settings.

Adding a Device to the Main Task

01. Select an "Input Reference" from the menu bar and add it to your main program.
02. Select "Stratos_Multi_E471N" for this input reference.
03. Select the desired parameter.

Example of Cyclic Input and Output Values

01. Menu Run Mode ▶ MainProgram – Function_Block
All 20 AIs, one AO, and two DOs are used with status.

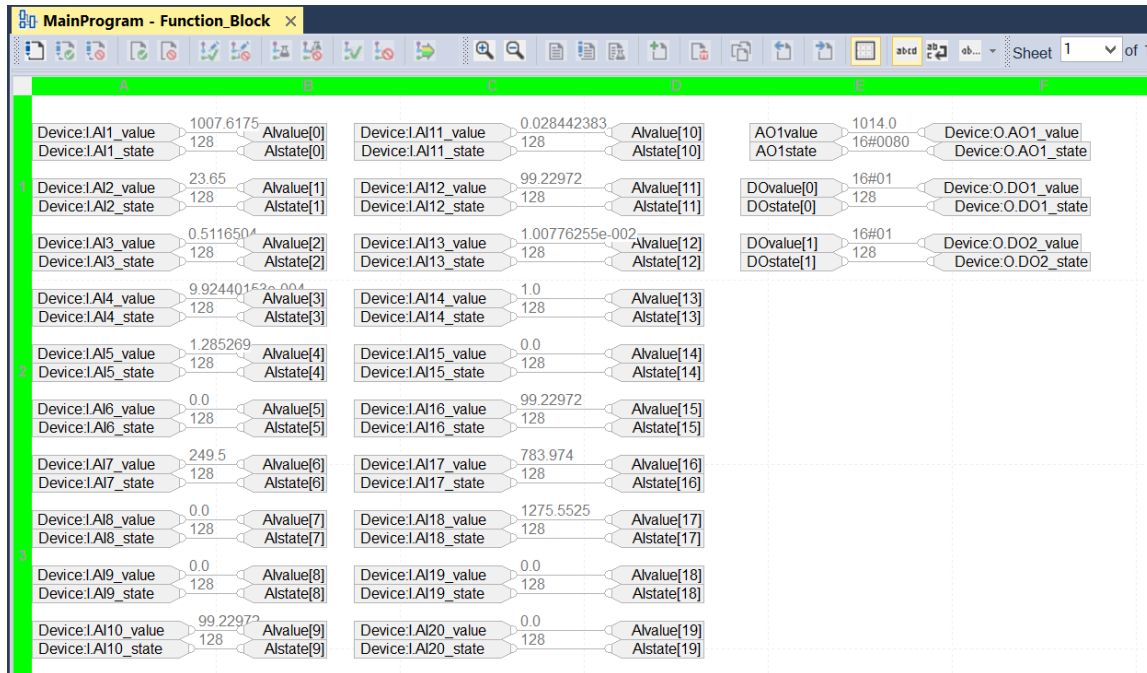

Example of Parameter Setting and Product Calibration

01. Menu Module Properties ▶ Parameters ▶ Module Properties: Local
The parameters are read cyclically by the controller. After any changes made by the user, they are written to the device by pressing the "Set" button.
Not all parameters can be changed.

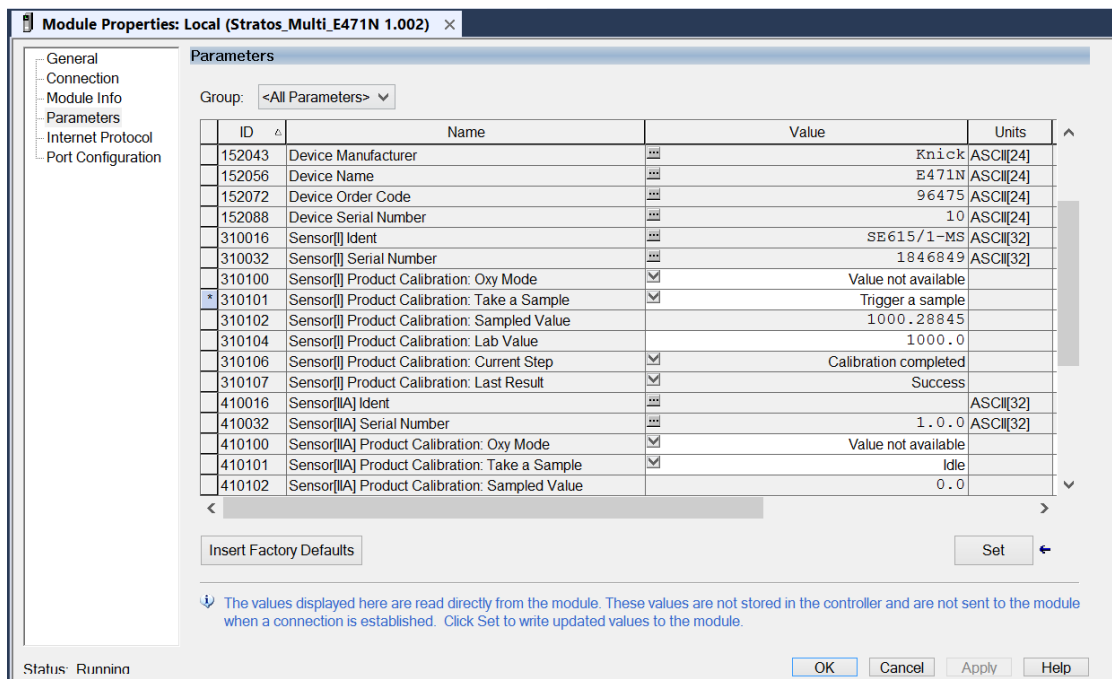

6.14.3 Product Calibration with Studio 5000 Logix Designer®

Product calibration must be performed either on the device or using Studio 5000. Product calibration on the device → *Calibration/Adjustment, p. 112*

Product Calibration Procedure

Step	Parameters	Description
1	e.g., Oxy Mode	Select Saturation or Concentration. Ignore this parameter if using pH and conductivity.
2	Take a Sample	Press the "Set" button to transmit the "Trigger a Sample" command to the device. At the same time, take a sample and calculate the lab value.
3	Sampled Value	Shows the measured value at the time of sampling.
4	Lab Value	When the lab value is available, enter it here and transmit it to the device by pressing the "Set" button.
5	Current Step	Shows the current status of the product calibration procedure.
6	Last Result	Shows the calibration result.

6.14.4 Local Operation

Displaying the Communication Status

The module and network statuses are indicated by an icon on the device display:



Module Status MS Indicator

Color	Status	Description
Green	On	Device is ready for operation and is running correctly.
Green	Flashing	Device is in standby and is not configured.
Green/red/ green	Flashing	Test sequence is running: The test sequence for the display of the module status is performed before the test sequence for the network status display, according to the following sequence: Network status indicator off. Module status indicator lights green, red, green and keeps this status until the test is completed. Network status indicator lights green, red, and then goes out. It remains in this state until the end of the test.
Red	Flashing	Error message: The device has detected an error that can be fixed e.g., an incorrect or inconsistent configuration. Check the EtherNet/IP configuration settings.
Red	On	Error message: The device has detected an error that cannot be fixed easily. Check the EtherNet/IP configuration settings.

Network Status NS Indicator

Color	Status	Description
Green	On	Device is connected: The IP address is configured and at least one CIP connection is established. The time limit was not exceeded for the Exclusive Owner connection.
Green	Flashing	No connection: An IP address is configured but no CIP connection has been established and the time limit for the Exclusive Owner connection has not been exceeded.
Green/red/off	Flashing	Test sequence is running: The test sequence for the module status indicator is performed before the test sequence for the network status indicator begins. Network status indicator lights green, red, and then goes out. It remains in this state until the end of the test.
Red	Flashing	Timeout of the connection: An IP address is configured but the time limit for the Exclusive Owner connection was exceeded, for which this device is the destination. The network status indicator will be only set permanently to green when the Exclusive Owner connection has been restored.
Red	On	Duplicate IP: The device has detected that the IP address is already in use.
	Off	No connection, no IP address: The device has no IP address or is not connected to the Ethernet port.

6.14.5 Configuring the Measured Values

01. Parameter Setting ▶ Administrator Level ▶ EtherNet/IP ▶ Measured Values
02. Select process variables for AI1 to AI20.

When configuring the measured values in the control system, a measured value must be selected for AI1 to AI20. Since the measured values are not automatically recognized by the control system, the device measured values AI1 to AI20 must be correctly assigned to the control system.

Available Measured Values

Note: The available selection depends on the sensor type used.

Data Source: pH/ORP Measurement

Measured Values	Unit of Measurement	State
pH value	pH	Variable
ORP	mV	Variable
Temperature	°C	Variable
pH voltage	mV	Variable
rH value		Variable
Glass impedance	Ω	Variable
Reference impedance	Ω	Variable
pH zero point	pH	Constant
pH slope	mV/pH	Constant
ISFET operating point	mV	Constant
ORP offset	%	Constant
Sensoface		Constant
Calibration timer	h	Variable
Wear	%	Variable
Remaining lifetime	d	Variable
TTM maintenance timer	d	Variable
DLI Lifetime Indicator	h	Variable
Operating time	d	Constant
SIP counter		Constant
CIP counter		Constant
Autoclaving counter		Constant

Data Source: Oxygen Measurement

Measured Values	Unit of Measurement	State
Sat. %Air	%	Variable
Saturation %O ₂	%	Variable
Temperature	°C	Variable
Conc. (liquid)	mg/l, µg/l, ppm, ppb	Variable
Conc. (gas)	Vol%	Variable
Sensor current	nA	Variable
Partial pressure	mbar, mmHg	Variable
Sensor current (25 °C)	nA	Variable
Process pressure	mbar, kPa, psi	Variable
Oxy zero point	nA	Constant
Oxy slope	nA	Constant
Stern-Volmer constant		Constant
Phase angle	°	Constant
Sensoface		Constant
Calibration timer	h	Variable
Wear	%	Variable
Membrane wear	%	Constant
Interior body wear	%	Constant
Impedance	Ω	Variable
TTM maintenance timer	d	Variable
DLI Lifetime Indicator	h	Variable
Operating time	d	Constant
SIP counter		Constant
CIP counter		Constant
Autoclaving counter		Constant

Data Source: Conductivity Measurement

Measured Values	Unit of Measurement	State
Conductivity	S/cm	Variable
Temperature	°C	Variable
Salinity	‰	Variable
Concentration	%	Variable
Resistivity	MΩ·cm	Variable
USP value		Variable
TDS	mg/l	Variable
Conductance	MΩ·cm	Variable
Resistance		Variable
Cell constant	cm ⁻¹	Constant
Installation factor		Constant
Zero point		Constant
Sensoface		Constant
Operating time	d	Constant
SIP counter		Constant
CIP counter		Constant

6.14.6 State

A status byte is transmitted together with the measured value. The status byte provides information about the reliability and the usability (quality and substate) of this particular measured value.

Status byte		Quality	Substate	Information
hex	dec			
0x80 to 0x83	128 to 131	Good	Ok	The measured value is valid.
0xA8 to 0xAB	168 to 171	Good	Maintenance required	The measured value is valid, but maintenance is required.
0xBC	188	Good	Function check	The measured value is valid and the device is in function check mode.
0x40 to 0x7F	64 to 127	Uncertain	Maintenance required	The reliability of the measured value is limited. Check the device diagnostic messages.
0x3C	60	Bad	Function check	The measured value cannot be used and the device is in function check mode.
0x25 to 0x27	37 to 39	Bad	Incorrect configuration	The measured value cannot be used. Check the device configuration, data source, limits, and the device diagnostic messages.
0x24	36	Bad	Device Failure	The measured value cannot be used. Internal device failure. Check the device diagnostic messages.

6.14.7 Diagnostics

Displaying the Current IP and MAC Addresses

01. Menu Selection ▶ Diagnostics ▶ Network Information

The screenshot shows a menu titled "Network Information" with a "DIAG" button and a status indicator (MS NS) with two green dots. The menu lists the following information:

Ipv4 Address	192,168,016,010
IPv4 Subnet Mask	255.255.255.000
IPv4 Standard Gateway	000.000.000.000
MAC Address	00:19:10:00:00:00

At the bottom, there are two buttons: "Back" and "Back to Meas."

Displaying the Current AI, AO, DO Values

01. Menu Selection ▶ Diagnostics ▶ EtherNet/IP Monitor

The screenshot shows a menu titled "Analog Input" with a "DIAG" button and a status indicator (MS NS) with two green dots. The menu lists the following information:

AI 1	1.123e+02 %Air	0x80 GOOD (G)
AI 2	5.307e+00 mg/l	0x80 GOOD (G)
AI 3	6.000e+01 °C	0x80 GOOD (G)
AI 4	1.013e+03 mbar	0x80 GOOD (G)
AI 5	-6.994e+01 nA	0x80 GOOD (G)
AI 6	nan	0x27 BAD (F)

At the bottom, there are two buttons: "Back" and "Back to Meas."

6.14.8 Connections to the Controller

Data direction	Assembly instance	Size [byte]
Exclusive Owner O→T	100	12
Exclusive Owner T→O	101	120
Listen Only T→O	101	120
Input Only T→O	101	120

Consuming Assembly (O→T), Instance 100

When performing the oxygen measurement, the value from an external pressure transmitter can be used for compensation via AO 1 if the corresponding parameter has been set.

→ *Pressure Correction, p. 100*

Relay contacts K 1, K 2 can be controlled via DO 1 and DO 2 if the corresponding parameter has been set.

Name	Byte offset	Size [byte]	Data type
AO1.value	0	4	REAL
AO1.state	4	2	INT
DO1.value	8	1	BYTE
DO2.value	9	1	BYTE
DO1.state	10	2	INT
DO2.state	12	2	INT

Producing Assembly (T→O), Instance 101

Name	Byte offset	Size [byte]	Data type
AI1.value	0	4	REAL
AI2.value	4	4	REAL
AI3.value	8	4	REAL
AI4.value	12	4	REAL
AI5.value	16	4	REAL
AI6.value	20	4	REAL
AI7.value	24	4	REAL
AI8.value	28	4	REAL
AI9.value	32	4	REAL
AI10.value	36	4	REAL
AI11.value	40	4	REAL
AI12.value	44	4	REAL
AI13.value	48	4	REAL
AI14.value	52	4	REAL
AI15.value	56	4	REAL
AI16.value	60	4	REAL
AI17.value	64	4	REAL
AI18.value	68	4	REAL
AI19.value	72	4	REAL
AI20.value	76	4	REAL
AI1.state	80	2	INT
AI2.state	82	2	INT
AI3.state	84	2	INT
AI4.state	86	2	INT

Name	Byte offset	Size [byte]	Data type
AI5.state	88	2	INT
AI6.state	90	2	INT
AI7.state	92	2	INT
AI8.state	94	2	INT
AI9.state	96	2	INT
AI10.state	98	2	INT
AI11.state	100	2	INT
AI12.state	102	2	INT
AI13.state	104	2	INT
AI14.state	106	2	INT
AI15.state	108	2	INT
AI16.state	110	2	INT
AI17.state	112	2	INT
AI18.state	114	2	INT
AI19.state	116	2	INT
AI20.state	118	2	INT

6.15 Flow

Stratos Multi can calculate flow for limit value messages or for monitoring an ion exchanger. A pulse generator is connected to control input OK1 for this purpose.

Parameter Setting

The "Flow" function must first be assigned to control input OK1.

01. System Control ▶ Function Control
02. Input OK1 : Select "Flow".
03. Parameter Setting main menu: 2x *left softkey: Back*
04. Inputs/Outputs ▶ Control Inputs ▶ Flow
05. Enter the number of pulses per liter.
06. If required, enable monitoring of the minimum and maximum flow.

The flow measurement can process up to 100 pulses per second at the signal input of control input OK1.

Flow Monitoring when an External Flow Transmitter is Connected

Factory setting to generate a failure message

Minimum flow	5 liters/h
Maximum flow	25 liters/h

The flow messages can activate a relay contact and/or trigger a 22 mA message via a current output (user-defined).

7 Calibration/Adjustment

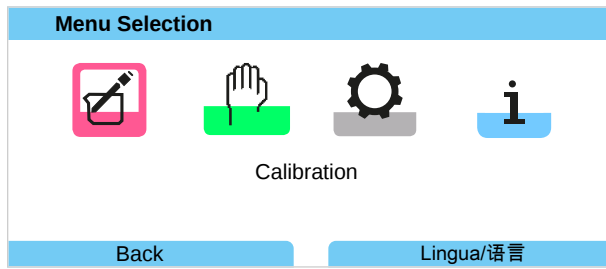

During calibration, Stratos Multi remains in calibration mode until stopped by qualified personnel. When calibration mode is exited, a confirmation prompt is displayed to ensure that the system is ready for operation again.

Assigning passcodes helps to ensure that only qualified personnel with access rights are allowed to do calibrations and adjustments.

The passcodes can be changed or disabled:

Parameter Setting ▶ System Control ▶ Passcode Entry → *Passcode Entry, p. 48*

Adjustment

Adjustment involves transferring the calibration values obtained during calibration to the device or the digital sensor.

Display of calibration values in the adjustment record:

Menu Selection ▶ Diagnostics ▶ I/II [Sensor] ▶ Cal/Adj Record [Process Variable]

NOTICE! Without adjustment, a transmitter will supply an imprecise or incorrect measured value. For it to measure properly Stratos Multi, must be adjusted. When using analog sensors, adjustment is required following sensor replacement.

Adjustments may also be made later:

01. After completing calibration, press the **left softkey: Calibrate**.
 - ✓ The "Calibration Was Successful" information window appears.
02. **Right softkey: Close**
03. Either: Exit the Calibration menu with **left softkey: Back** and then open it again
04. Or: Remain in the Calibration menu and open Calibration again.
 - ✓ A selection window appears.

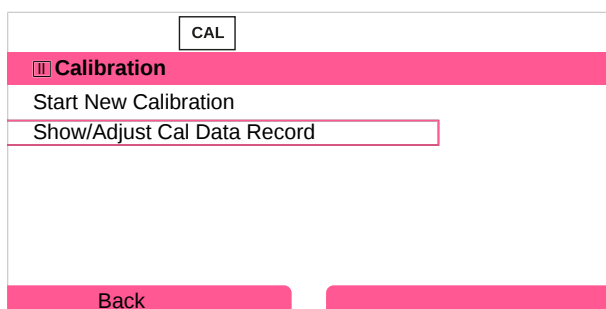

05. Select "Show/Adjust Cal Data Record".
 - ✓ The calibration record is displayed.

06. **Right softkey: Adjust**

Note: The calibration data is saved in the Memosens sensor. This means that Memosens sensors can be cleaned, reconditioned, calibrated, and adjusted away from the measuring point, e.g., in a laboratory. Sensors in the system are replaced on-site by adjusted sensors.

First Adjustment

Note: Function active for ISM pH/ORP sensors and amperometric ISM oxygen sensors.

When you open the Calibration menu, you can choose to save the current calibration as the first adjustment.

The adjustment record values are then shown as a reference in the **Statistics** diagnostics menu.

→ *Statistics, p. 148*

7.1 Calibration/Adjustment Memosens

Menu Selection ▶ Calibration ▶ [I] [II] Memosens ...

Note: The calibration data is saved in the Memosens sensor. This means that Memosens sensors can be cleaned, reconditioned, calibrated, and adjusted away from the measuring point, e.g., in a laboratory. Sensors in the system are replaced on-site by adjusted sensors.

7.2 pH Process Variable Calibration/Adjustment

- Calibration: Detect deviations without readjustment of calibration data
- Adjustment: Detect deviations with readjustment of calibration data

NOTICE! When using analog sensors, adjustment is required following sensor replacement.

7.2.1 Explanations for pH Calibration/Adjustment

Each pH sensor has an individual zero point and an individual slope. Both values change as a result of aging and wear. The voltage supplied by the pH sensor is corrected by Stratos Multi for the zero point and the electrode slope of the pH sensor, and displayed as the pH value.

During calibration, first the deviation of the sensor is determined (zero point, slope). The sensor is immersed in buffer solutions with a precisely known pH value for this purpose. Stratos Multi measures the voltages of the sensor and the temperature of the buffer solution, and uses this information to calculate the zero point and slope of the sensor.

Calibration Values Determined During Calibration

Zero Point	The pH value at which the pH sensor supplies the voltage 0 mV. The zero point is different for each sensor and changes with age and wear.
Slope	The slope of a sensor is the voltage change per pH unit. With an ideal sensor, it is -59.2 mV/pH.
Temperature	The temperature of the process solution must be logged, since the pH measurement is temperature-dependent. Many sensors feature an integrated temperature detector.

There are limit values that are calculated during calibration when monitoring glass and reference impedances. The following limit values apply to standard glass electrodes:

- Temperature range: 0 ... 80 °C (32 ... 176 °F)
- Impedance range: 50 ... 250 MΩ at 25 °C (77 °F)

7.2.2 Calibration Procedure

One-point Calibration

The sensor is calibrated with just one buffer solution. A one-point calibration is useful and permissible if the measured values are close to the sensor zero point, such that the change in sensor slope is of minor significance. The zero point of the sensor is subsequently adjusted. The slope remains unchanged.

Two-point Calibration

The sensor is calibrated with two buffer solutions. This makes it possible to calculate the zero point and slope of the sensor. The zero point and slope of the sensor are subsequently adjusted. Two-point calibration is required in the following cases, for example, the:

- Sensor was replaced
- pH measured value covers a large range
- pH measured value is far away from the sensor zero point
- pH value must be measured with high precision
- Sensor is subject to heavy wear

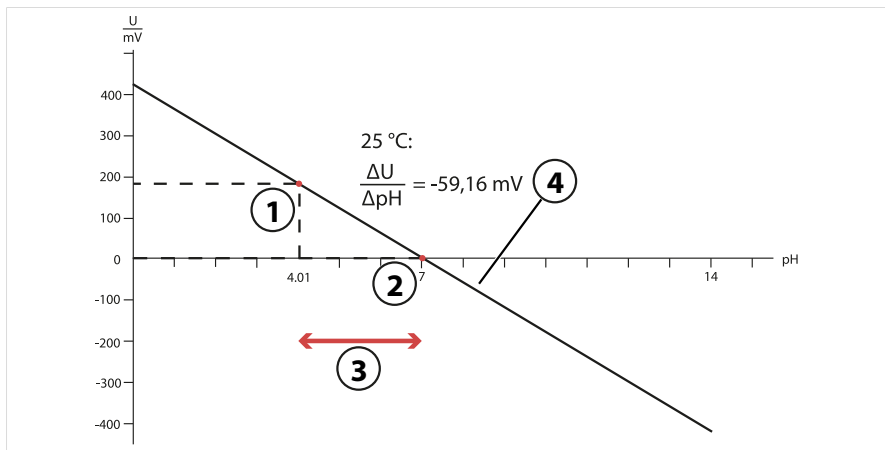

1 First point of first buffer solution	3 Recommended measuring range
2 Second point of second buffer solution	4 Result of ideal calibration at 25 °C (77 °F)

Three-point Calibration

The sensor is calibrated with three buffer solutions.

The zero point and slope are calculated with a line of best fit in accordance with DIN 19268. The zero point and slope of the sensor are subsequently adjusted.

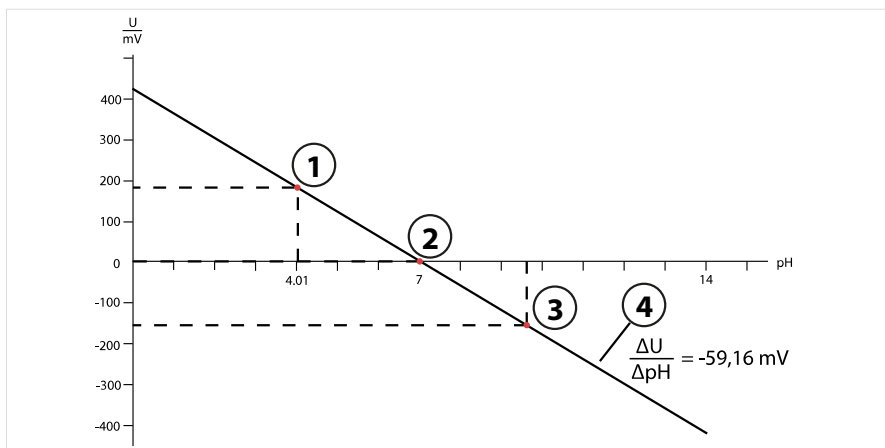

1 First point of first buffer solution	3 Third point of third buffer solution
2 Second point of second buffer solution	4 Rise

7.2.3 Temperature Compensation during Calibration

The slope of the pH sensor is temperature-dependent. The measured voltage must therefore be corrected by the temperature influence.

The pH value of the buffer solution is temperature-dependent. During calibration, the temperature of the buffer solution must therefore be known so that the actual pH value can be obtained from the buffer table.

Automatic Temperature Compensation

Stratos Multi measures the temperature of the buffer solution with the temperature detector integrated into the pH sensor.

Sensors without Integrated Temperature Detector

If the sensor does not have an integrated temperature detector:

- Connect an external temperature detector and select it in the Parameter Setting menu.
→ *Channel II Wiring Examples, p. 218*
- Specify the manual temperature for calibration.

The settings are made in the **Temperature Detection** submenu:

Menu Selection ▶ Parameter Settings ▶ [II] Analog ... ▶ Sensor Data ▶ Temperature Detection

7.2.4 Calibration/Adjustment Options

- Calimatic: Automatic buffer recognition
- Manual: Manual entry of buffer values
- Product: Calibration by sampling
- Data entry: Data entry of premeasured sensors
- Temperature: Temperature detector adjustment

7.2.5 Calibration Mode: Calimatic

Calibration with Automatic Buffer Recognition

During automatic calibration with Knick, the sensor is immersed in one, two or three buffer solutions. Stratos Multi automatically detects the nominal buffer value on the basis of the sensor voltage and the measured temperature. The buffer solutions can be used in any order, but they must be part of the buffer set defined during parameter setting. Calimatic accounts for the temperature dependence of the buffer value. All calibration data is converted to a reference temperature of 25 °C/77 °F.

Calibration Procedure

NOTICE! Faulty calibration results in faulty output values. Use only new, undiluted buffer solutions that are part of the configured buffer set.

Calibration ▶ [I] [II] ... pH

When you access calibration, the calibration values selected in the calibration presettings are used. These settings can still be changed in the Calibration menu. If you do not want to perform calibration, use the left **softkey** to go back one level and abort the calibration.

01. Select "Calimatic" **Calibration Mode** and confirm with **enter**.
✓ Number of calibrations points and buffer set configured as in **Cal Presettings**.
→ *Calibration Presettings, p. 70*
02. If required, change the number of calibration points and the buffer set.
03. Remove the sensor from the medium and rinse it in deionized water.

⚠ CAUTION! Risk of electrostatic charging. Do not wipe the sensor or dab it dry.

04. Immerse sensor in 1st buffer solution.

05. Start calibration with **right softkey: Next**.

✓ Calibration with first buffer is performed.

The following parameters are displayed: Sensor voltage, calibration temperature, nominal buffer value, and settling time.

The time for the measuring voltage to stabilize can be shortened with the **left softkey: Exit** (without drift check: reduced accuracy of calibration values). The settling time indicates how long the sensor needs until the measuring voltage is stable. If the sensor voltage or the measured temperature fluctuate considerably, the calibration procedure is aborted after around 2 minutes. In this case, calibration needs to be restarted. Return the sensor to the process once this has been successfully completed. Make sure that the temperature of the sensor and the temperature of the buffer solution are not too far apart. The ideal temperature is 25 °C/77 °F.

06. For one-point calibration: Exit calibration with the **softkey**.

07. For two-point calibration: Rinse the sensor well with deionized water.

08. Immerse sensor in 2nd buffer solution.

09. Start calibration with **right softkey: Next**.

✓ Calibration with second buffer is performed.

10. Proceed as for one-point calibration.

11. For three-point calibration, the process uses the third buffer accordingly.

✓ The calibration record is displayed. Confirm with **right softkey: Adjust**, the calibration values obtained during calibration for calculation of the process variables are applied to the device. When using a Memosens sensor, the calibration values are saved in the sensor.

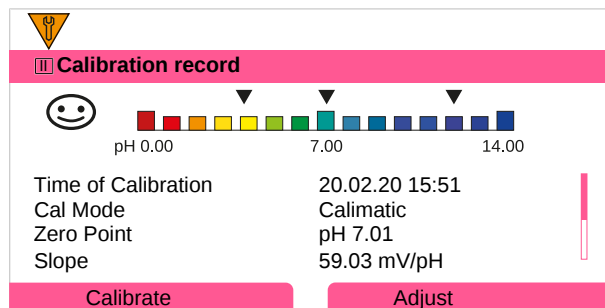

7.2.6 Calibration Mode: Manual

During calibration with manual entry of buffer values, the sensor is immersed in one, two, or three buffer solutions. Stratos Multi displays the measured temperature. The temperature-corrected buffer values must then be manually entered. For this purpose, take the buffer value that goes with the displayed temperature from the buffer table (e.g., on the bottle). Intermediate values must be interpolated. All calibration data is converted to a reference temperature of 25 °C/77 °F

Calibration Procedure

NOTICE! Faulty calibration results in faulty output values. Use only new, undiluted buffer solutions that are part of the configured buffer set.

Calibration ▶ [I] [II] ... pH

When you access calibration, the calibration values selected in the calibration presets are used. These settings can still be changed in the Calibration menu. If you do not want to perform calibration, use the left **softkey** to go back one level and abort the calibration.

01. Select "Manual" Calibration Mode and confirm with **enter**.
 - ✓ Number of calibration points configured as in Cal Presettings. → *Calibration Presettings, p. 70*
02. If required, change the number of calibration points.
03. 1. the first buffer value.
04. Continue with **right softkey: Next**.
05. Remove the sensor from the medium and rinse it well in deionized water.

▲ CAUTION! Risk of electrostatic charging. Do not wipe the sensor or dab it dry.

06. Immerse sensor in 1st buffer solution.
07. Start calibration with **right softkey: Next**.
 - ✓ Calibration with first buffer is performed.
 - The following parameters are displayed: Sensor voltage, calibration temperature, nominal buffer value, and settling time.

The time for the measuring voltage to stabilize can be shortened with the **left softkey: Exit** (without drift check: reduced accuracy of calibration values). The settling time indicates how long the sensor needs until the measuring voltage is stable. If the sensor voltage or the measured temperature fluctuate considerably, the calibration procedure is aborted after around 2 minutes. In this case, calibration needs to be restarted. Return the sensor to the process once this has been successfully completed. Make sure that the temperature of the sensor and the temperature of the buffer solution are not too far apart. The ideal temperature is 25 °C/77 °F.

08. For one-point calibration: Exit calibration with the **softkey**.
 09. For two-point calibration: Rinse the sensor well with deionized water.
 10. Immerse sensor in 2nd buffer solution.
 11. Enter the second temperature-corrected buffer value.
 12. Start calibration with **right softkey: Next**.
 - ✓ Calibration with second buffer is performed.
 13. Proceed as for one-point calibration.
 14. For three-point calibration, the process uses the third buffer accordingly.
- ✓ The calibration record is displayed. Confirm with **right softkey: Adjust**, the calibration values obtained during calibration for calculation of the process variables are applied to the device. When using a Memosens sensor, the calibration values are saved in the sensor.

7.2.7 Calibration Mode: Product

Calibration by Sampling

If the sensor cannot be removed – e.g., for sterility reasons – the zero point of the sensor can be determined by “sampling”. The current measured value of the process is saved in the device for this purpose. A sample is taken directly afterward at the measuring point. The pH value of the sample is measured in the laboratory. The reference value is entered in the device. Stratos Multi calculates the zero point of the sensor from the difference between the measured value and the reference value. The slope is not changed in the process.

Note: Product calibration can also be carried out via Ethernet.

→ *Product Calibration with Studio 5000 Logix Designer®*, p. 104

Calibration Procedure

NOTICE! The sample’s pH value is temperature-dependent. The reference measurement should be carried out at the sample temperature shown on the display. The sample should be transported in a vacuum flask. The sample’s pH value may also be falsified if volatile substances escape.

Calibration ▶ [I] [II] ... pH

When you access calibration, the calibration values selected in the calibration presets are used. These settings can still be changed in the Calibration menu. If you do not want to perform calibration, use the left **softkey** to go back one level and abort the calibration.

01. Select “Product” Calibration Mode and confirm with **enter**.
02. Prepare for sampling.
03. Start with **right softkey: Next**.

Product calibration is performed in 2 steps.

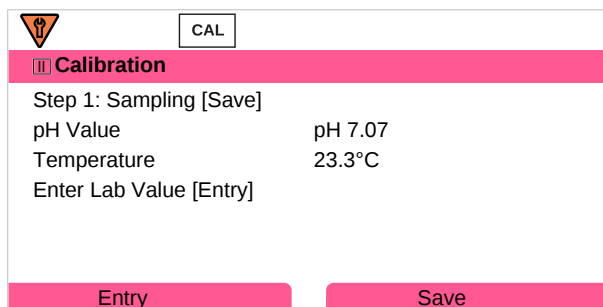

Step 1:

04. Take sample.
 - ✓ The measured value and temperature at the time of sampling are displayed.
05. Save with **right softkey: Save**.
 - ✓ An information window is displayed.
06. **Right softkey: Close**
07. If required, exit calibration with the **left softkey: Back**.

Note: The icon  indicates that product calibration has not yet been completed.

Step 2: Lab value is present.

08. Open the Product Calibration menu again.

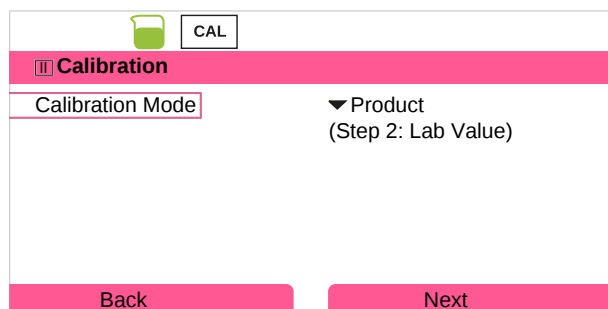

09. **Right softkey: Next**

10. Enter the lab value and confirm with **enter**.

11. Confirm with **right softkey: Next** or repeat calibration with **left softkey: Cancel**.

✓ The calibration record is displayed. Confirm with **right softkey: Adjust**, the calibration values obtained during calibration for calculation of the process variables are applied to the device. When using a Memosens sensor, the calibration values are saved in the sensor.

Exception: Sample value can be determined and immediately entered on site:

12. Take sample.

✓ The measured value and temperature at the time of sampling are displayed.

13. **Left softkey: Entry**

14. Enter the lab value and confirm with **enter**.

15. Confirm with **right softkey: Next** or repeat calibration with **left softkey: Cancel**.

✓ The calibration record is displayed. Confirm with **right softkey: Adjust**, the calibration values obtained during calibration for calculation of the process variables are applied to the device. When using a Memosens sensor, the calibration values are saved in the sensor.

7.2.8 Calibration Mode: Data Entry

Calibration by entering the calibration values for the zero point and the slope of a pre-measured sensor.

Calibration Procedure

Calibration ▶ [I] [II] ... pH

When you access calibration, the calibration values selected in the calibration presettings are used. These settings can still be changed in the Calibration menu. If you do not want to perform calibration, use the left **softkey** to go back one level and abort the calibration.

01. Select "Data Entry" **Calibration Mode** and confirm with **enter**.

02. Remove the sensor and install the pre-measured sensor.

03. Continue with **right softkey: Next**.

04. Enter the zero point and slope measured values.

05. With TAN option FW-E017 and with a Pfaudler pH sensor, you can also enter the pH_{is} value for the isothermal intersection point. → *Pfaudler Sensors (FW-E017), p. 192*

✓ The calibration record is displayed. Confirm with **right softkey: Adjust**, the calibration values obtained during calibration for calculation of the process variables are applied to the device. When using a Memosens sensor, the calibration values are saved in the sensor.

7.2.9 Calibration Mode: ISFET Zero Point

Setting the ISFET Operating Point

When Memosens ISFET sensors are used for pH measurement, the individual operating point of the sensor first needs to be determined. This should be in the pH 6.5 ... pH 7.5 range. The sensor is immersed in a buffer solution with a pH value of 7.00 for this purpose.

Calibration Procedure

Calibration ▶ [I] [II] ... pH-ISFET

When you access calibration, the calibration values selected in the calibration presettings are used. These settings can still be changed in the Calibration menu. If you do not want to perform calibration, use the left **softkey** to go back one level and abort the calibration.

01. Select "ISFET Zero" Calibration Mode to set the operating point for the first sensor calibration and confirm with **enter**.
02. Press the **right softkey: Next**.
03. Adjust the buffer value if necessary: Default value pH 7.00
04. Remove the sensor from the medium and rinse it well in deionized water.

▲ CAUTION! Risk of electrostatic charging. Do not wipe the sensor or dab it dry.

05. Immerse the sensor in buffer solution.
06. Start calibration with **right softkey: Next**.
✓ The ISFET operating point is determined.
07. Apply the ISFET operating point with the **right softkey: Adjust**.

A pH calibration, e.g., Calimatic 2-point calibration, can be performed afterward.

Note: The operating point only needs to be determined once for each ISFET sensor.

7.2.10 Calibration Mode: Temperature

Adjusting the Temperature Detector

This function is used to adjust the individual tolerance of the temperature detector or cable lengths to increase temperature measurement accuracy.

The adjustment requires an accurate measurement of the process temperature with a calibrated reference thermometer. The measurement error of the reference thermometer should be less than 0.1 K. Adjustment without an accurate measurement of the process temperature may result in falsification of the displayed measured value.

For Memosens sensors, the adjustment value is saved in the sensor.

Calibration Procedure

Calibration ▶ [I] [II] [Sensor]

01. Select "Temperature" Calibration Mode and confirm with **enter**.
02. Enter the measured process temperature and confirm with **enter**.
✓ The temperature offset is displayed.
03. Press **right softkey: Save** to calibrate the temperature detector.

The data of the current adjustment and temperature offset can be opened in the Diagnostics menu:

Diagnostics ▶ [I] [II] [Sensor] ▶ Temp. Offset Log

7.3 ORP Process Variable Calibration/Adjustment

- Calibration: Detect deviations without readjustment of calibration data
- Adjustment: Detect deviations with readjustment of calibration data

NOTICE! When using analog sensors, adjustment is required following sensor replacement.

7.3.1 Calibration/Adjustment Options

- ORP Data Entry
- ORP Adjustment
- ORP Check
- Temperature detector adjustment

7.3.2 Calibration Mode: ORP Data Entry

Calibration by entering the ORP offset of a pre-measured sensor.

Calibration Procedure

Calibration ▶ [I] [II] [ORP Sensor]

When you access calibration, the calibration values selected in the calibration presettings are used. These settings can still be changed in the Calibration menu. If you do not want to perform calibration, use the left **softkey** to go back one level and abort the calibration.

01. Select "Enter ORP data" **Calibration Mode** and confirm with **enter**.
02. Remove the sensor and install the pre-measured sensor.
03. Continue with **right softkey: Next**.
04. Enter the ORP offset value.

✓ The calibration record is displayed. Confirm with **right softkey: Adjust**, the calibration values obtained during calibration for calculation of the process variables are applied to the device. When using a Memosens sensor, the calibration values are saved in the sensor.

7.3.3 Calibration Mode: ORP Adjustment

The sensor is immersed in an ORP buffer solution for ORP adjustment. Stratos Multi displays the measured temperature and the ORP. The temperature-corrected buffer values must then be manually entered. For this purpose, take the buffer value that goes with the displayed temperature from the buffer table (e.g., on the bottle). Intermediate values must be interpolated. All calibration data is converted to a reference temperature of 25 °C/77 °F

Calibration Procedure

Calibration ▶ [I] [II] [ORP Sensor]

When you access calibration, the calibration values selected in the calibration presettings are used. These settings can still be changed in the Calibration menu. If you do not want to perform calibration, use the left **softkey** to go back one level and abort the calibration.

01. Select "ORP adjustment" **Calibration Mode** and confirm with **enter**.
02. Continue with **right softkey: Next**.
03. Remove the sensor from the medium and rinse it well in deionized water.

▲ CAUTION! Risk of electrostatic charging. Do not wipe the sensor or dab it dry.

04. Immerse the sensor in ORP buffer solution and wait for the ORP measured value to stabilize.
05. Start calibration with **right softkey: Next**.
 - ✓ When the drift check is complete, the measured temperature and ORP are displayed.

The time for the measuring voltage to stabilize can be shortened with the **left softkey: Exit** (without drift check: reduced accuracy of calibration values). The settling time indicates how long the sensor needs until the measuring voltage is stable. If the sensor voltage or the measured temperature fluctuate considerably, the calibration procedure is aborted after around 2 minutes. In this case, calibration needs to be restarted. Return the sensor to the process once this has been successfully completed. Make sure that the temperature of the sensor and the temperature of the buffer solution are not too far apart. The ideal temperature is 25 °C/77 °F.

06. Enter the ORP setpoint (printed on flask) of the buffer solution in the Calibration Mode ▶ ORP Adjustment ▶ Redox Buffer submenu and confirm with **enter**.

Enter ORP Setpoint	
Temperature	23.3°C
ORP	215 mV
Redox Buffer	218.3 mV

07. Press **right softkey: Next** to end the calibration.

- ✓ The calibration record is displayed. Confirm with **right softkey: Adjust**, the calibration values obtained during calibration for calculation of the process variables are applied to the device. When using a Memosens sensor, the calibration values are saved in the sensor.

7.3.4 Calibration Mode: ORP Check

The sensor is immersed in a solution with a known ORP value for the ORP check. The test period and the permissible test difference are specified during parameter setting:

Parameter Setting ▶ [I] [II] [ORP Sensor] ▶ Cal Presettings

Calibration Procedure

Calibration ▶ [I] [II] [ORP Sensor]

When you access calibration, the calibration values selected in the calibration presettings are used. These settings can still be changed in the Calibration menu. If you do not want to perform calibration, use the left **softkey** to go back one level and abort the calibration.

01. Select "ORP check" Calibration Mode and confirm with **enter**.
02. Remove the sensor from the medium and rinse it well in deionized water.
- ▲ **CAUTION! Risk of electrostatic charging.** Do not wipe the sensor or dab it dry.
03. Immerse the sensor in the ORP solution and wait for the ORP measured value to stabilize.
04. Start the ORP check with **right softkey: Next**.
 - ✓ When the drift check is complete, the measured temperature and ORP are displayed.
 - ✓ If the specified test difference was not exceeded, the message "ORP Check Successful" appears. If the specified test difference was exceeded, the message "ORP Check not Successful" appears.
05. Do an ORP adjustment if the ORP check was unsuccessful.

7.3.5 Calibration Mode: Temperature

Adjusting the Temperature Detector

This function is used to adjust the individual tolerance of the temperature detector or cable lengths to increase temperature measurement accuracy.

The adjustment requires an accurate measurement of the process temperature with a calibrated reference thermometer. The measurement error of the reference thermometer should be less than 0.1 K. Adjustment without an accurate measurement of the process temperature may result in falsification of the displayed measured value.

For Memosens sensors, the adjustment value is saved in the sensor.

Calibration Procedure

Calibration ▶ [I] [II] [Sensor]

01. Select "Temperature" Calibration Mode and confirm with **enter**.
02. Enter the measured process temperature and confirm with **enter**.
 - ✓ The temperature offset is displayed.
03. Press **right softkey: Save** to calibrate the temperature detector.

The data of the current adjustment and temperature offset can be opened in the Diagnostics menu:

Diagnostics ▶ [I] [II] [Sensor] ▶ Temp. Offset Log

7.4 Conductivity (Contacting) Process Variable Calibration/Adjustment

- Calibration: Detect deviations without readjustment of calibration data
- Adjustment: Detect deviations with readjustment of calibration data

NOTICE! When using analog sensors, adjustment is required following sensor replacement.

7.4.1 Explanations Regarding Calibration/Adjustment with 2-/4-Electrode Sensors

Each conductivity sensor has an individual cell constant. Depending on the sensor design, the cell constant may vary over a wide range. Because the conductivity value is calculated from the measured conductance and the cell constant, the device must know the cell constant. During calibration or sensor adjustment, either the known (printed) cell constant of the conductivity sensor used is entered in the device, or it is determined automatically by measuring a calibration solution with known conductivity.

Notes on Calibration

- Use only fresh calibration solutions. The parameters of the calibration solution used must be set.
- Calibration accuracy of the is crucially dependent on precise acquisition of the calibration solution temperature. Based on the measured or entered temperature, Stratos Multi calculates the setpoint of the calibration solution from a stored table.
- Note the settling time of the temperature probe.
- To determine the exact cell constant, wait for temperature equalization of the temperature detector and calibration solution before calibration.

Because the cell constant is subject to production-related fluctuations, we recommend calibrating the removed sensor with a calibration solution (e.g., saturated NaCl). The cell constants of the sensors are dependent on the installation geometry – especially in the case of fringe-field sensors:

- If the sensor is installed in a free space (minimum distances exceeded), the cell constant from the specifications can be entered directly.
"Data entry" **Calibration Mode** . → *Calibration Mode: Data Entry, p. 129*
- If the installation space is tight (minimum distances are not reached), the sensor must be adjusted in its installed state, as the resulting cell constant has changed.
"Product" **Calibration Mode** . → *Calibration Mode: Product, p. 127*

7.4.2 Temperature Compensation during Calibration

The conductivity value of the calibration solution is temperature-dependent. During calibration, the temperature of the calibration solution must therefore be known so that the actual value can be obtained from the conductivity table.

Automatic Temperature Compensation

During automatic logging of the calibration temperature, Stratos Multi measures the temperature of the calibration solution using the temperature detector integrated in the Memosens sensor.

If the sensor does not have an integrated temperature detector:

- Connect an external temperature detector and select it in the Parameter Setting menu.
→ *Channel II Wiring Examples, p. 218*
- Specify the manual temperature for calibration.

The settings are made in the **Temperature Detection** submenu:

Menu Selection ▶ **Parameter Settings** ▶ **[II] Analog ...** ▶ **Sensor Data** ▶ **Temperature Detection**

7.4.3 Calibration/Adjustment Options

- Automatic calibration: Automatic with standard calibration solution
- Manual: Manual entry of a calibration solution
- Product: Product calibration (calibration with sampling)
- Data entry: Data entry of premeasured sensors
- Temperature: Temperature detector adjustment

7.4.4 Calibration Mode: Automatic

Automatic Calibration with Standard Calibration Solution

During automatic calibration, the conductivity sensor is immersed in a standard calibration solution (NaCl or KCl, set during parameter setting in the **Cal Presettings** submenu). Stratos Multi automatically calculates the cell constant on the basis of the measured conductance and temperature. The temperature dependence of the calibration solution is taken into account.

Notes on Calibration

- Use only fresh calibration solutions. The parameters of the calibration solution used must be set.
- Calibration accuracy of the is crucially dependent on precise acquisition of the calibration solution temperature. Based on the measured or entered temperature, Stratos Multi calculates the setpoint of the calibration solution from a stored table.
- Note the settling time of the temperature probe.
- To determine the exact cell constant, wait for temperature equalization of the temperature detector and calibration solution before calibration.
- If the measured conductance or temperature fluctuate greatly, the calibration procedure is aborted after approx. 2 min. Repeat calibration if an error message appears.

Calibration Procedure

Calibration ▶ [I] [II] ... Cond

When you access calibration, the calibration values selected in the calibration presettings are used. These settings can still be changed in the Calibration menu. If you do not want to perform calibration, use the left **softkey** to go back one level and abort the calibration.

01. Select "Automatic" **Calibration Mode** and confirm with **enter**.
 - ✓ Display of calibration solution as configured in **Cal Presettings**. → *Calibration Presettings, p. 82*
 02. Change the calibration solution if necessary.
 03. Remove the sensor from the medium and rinse it well in deionized water.
 04. Dip the sensor in the calibration solution.
 05. Start calibration with **right softkey: Next**.
 - ✓ Calibration is performed.
The following parameters are displayed: Calibration temperature, solution table value (conductivity depending on calibration temperature), and settling time.
- ✓ The calibration record is displayed. Confirm with **right softkey: Adjust**, the calibration values obtained during calibration for calculation of the process variables are applied to the device. When using a Memosens sensor, the calibration values are saved in the sensor.

7.4.5 Calibration Mode: Manual

Manual Calibration Specifying a Calibration Solution

During calibration with manual entry of the conductivity value of the calibration solution, the sensor is immersed in a calibration solution. Stratos Multi calculates a conductivity/calibration temperature pair value. The temperature-corrected conductivity value of the calibration solution must then be entered. For this purpose, take the conductivity value that goes with the displayed temperature from the calibration solution TC table. Conductivity intermediate values must be interpolated.

Stratos Multi automatically calculates the cell constant.

Notes on Calibration

- Use only fresh calibration solutions. The parameters of the calibration solution used must be set.
- Calibration accuracy of the is crucially dependent on precise acquisition of the calibration solution temperature. Based on the measured or entered temperature, Stratos Multi calculates the setpoint of the calibration solution from a stored table.
- Note the settling time of the temperature probe.
- To determine the exact cell constant, wait for temperature equalization of the temperature detector and calibration solution before calibration.
- If the measured conductance or temperature fluctuate greatly, the calibration procedure is aborted after approx. 2 min. Repeat calibration if an error message appears.

Calibration Procedure

Calibration ▶ [I] [II] ... Cond

When you access calibration, the calibration values selected in the calibration presettings are used. These settings can still be changed in the Calibration menu. If you do not want to perform calibration, use the left **softkey** to go back one level and abort the calibration.

01. Select "Manual" **Calibration Mode** and confirm with **enter**.
02. Take the sensor out of the medium, rinse it well in deionized water, and dry it.
03. Dip the sensor in the calibration solution.
04. Start calibration with **right softkey: Next**.
 - ✓ Calibration is performed.
The following parameters are displayed: Calibration temperature and settling time.
05. Enter the conductivity.
06. Continue with **right softkey: Next**.
 - ✓ The calibration record is displayed. Confirm with **right softkey: Adjust**, the calibration values obtained during calibration for calculation of the process variables are applied to the device. When using a Memosens sensor, the calibration values are saved in the sensor.

7.4.6 Calibration Mode: Product

Calibration by Sampling

If the sensor cannot be removed – e.g., for sterility reasons – its cell constant can be determined by “sampling”. The currently measured value (conductivity or concentration¹⁾) of the process is stored by Stratos Multi for this purpose. Immediately afterwards, take a sample from the process. The value of this sample is measured under process conditions (same temperature!) wherever possible. The calculated value is entered in the measuring system. Stratos Multi calculates the cell constant of the conductivity sensor from the deviation between the process measured value and the sample value.

Note: Product calibration can also be carried out via Ethernet.

→ *Product Calibration with Studio 5000 Logix Designer*[®], p. 104

Product Calibration without TC Compensation (With Conductivity)

A sample is taken from the process. The sample's measured value is determined in the laboratory at the temperature at which the sample was taken (“Sample Temperature”, see display). It may be necessary to thermostat the sample in the laboratory accordingly. Temperature compensation of the reference transmitters must be disabled (TC = 0 %/K).

Product Calibration with TC Compensation $T_{ref} = 25\text{ °C}/77\text{ °F}$ (With Conductivity)

A sample is taken from the process. During measurement in the laboratory (TC linear), the same values for reference temperature and temperature coefficient must be set in both the reference transmitter and Stratos Multi. In addition, the measuring temperature should match the sample temperature (see display) as closely as possible. The sample should be transported in a vacuum flask (Dewar) to ensure this.

NOTICE! Product calibration is only possible if the process medium is stable (no chemical reactions that affect conductivity). At higher temperatures, evaporation may falsify results.

Calibration Procedure

Calibration ▶ [I] [II] ... Cond

When you access calibration, the calibration values selected in the calibration presets are used. These settings can still be changed in the Calibration menu. If you do not want to perform calibration, use the left **softkey** to go back one level and abort the calibration.

01. Select “Product” Calibration Mode and confirm with **enter**.
02. Prepare for sampling.
03. Start with **right softkey: Next**.

Product calibration is performed in 2 steps.

CAL	
Calibration	
Step 1: Sampling [Save]	
Conductivity	1,249 mS/cm
Temperature	23.3°C
Enter Lab Value [Entry]	
Entry	Save

Step 1:

04. Take sample.
 - ✓ The measured value and temperature at the time of sampling are displayed.

¹⁾ First enable TAN option FW-E009. → *Concentration Determination (FW-E009)*, p. 187

05. Save with **right softkey: Save**.

✓ An information window is displayed.

06. **Right softkey: Close**

07. If required, exit calibration with the **left softkey: Back**.

Note: The icon  indicates that product calibration has not yet been completed.

Step 2: Lab value is present.

08. Open the Product Calibration menu again.

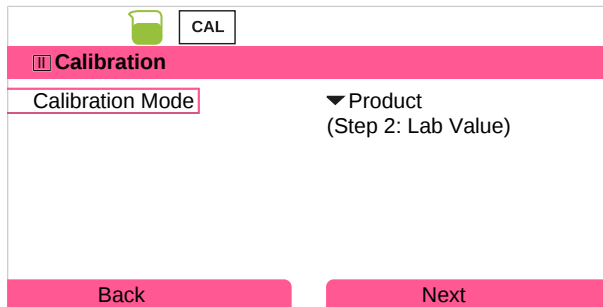

09. **Right softkey: Next**

10. Enter the lab value and confirm with **enter**.

11. Confirm with **right softkey: Next** or repeat calibration with **left softkey: Cancel**.

✓ The calibration record is displayed. Confirm with **right softkey: Adjust**, the calibration values obtained during calibration for calculation of the process variables are applied to the device. When using a Memosens sensor, the calibration values are saved in the sensor.

Exception: Sample value can be determined and immediately entered on site:

12. Take sample.

✓ The measured value and temperature at the time of sampling are displayed.

13. **Left softkey: Entry**

14. Enter the lab value and confirm with **enter**.

15. Confirm with **right softkey: Next** or repeat calibration with **left softkey: Cancel**.

✓ The calibration record is displayed. Confirm with **right softkey: Adjust**, the calibration values obtained during calibration for calculation of the process variables are applied to the device. When using a Memosens sensor, the calibration values are saved in the sensor.

7.4.7 Calibration Mode: Data Entry

Enter the values for the cell constant of a sensor, related to 25 °C (77 °F)

Calibration Procedure

Calibration ▶ [I] [II] ... Cond

When you access calibration, the calibration values selected in the calibration presettings are used. These settings can still be changed in the Calibration menu. If you do not want to perform calibration, use the left **softkey** to go back one level and abort the calibration.

01. Select "Data Entry" Calibration Mode and confirm with **enter**.
02. Remove the sensor and install the pre-measured sensor.
03. Continue with **right softkey: Next**.
04. Enter the cell constant of the pre-measured sensor.

✓ The calibration record is displayed. Confirm with **right softkey: Adjust**, the calibration values obtained during calibration for calculation of the process variables are applied to the device. When using a Memosens sensor, the calibration values are saved in the sensor.

7.4.8 Calibration Mode: Temperature

Adjusting the Temperature Detector

This function is used to adjust the individual tolerance of the temperature detector or cable lengths to increase temperature measurement accuracy.

The adjustment requires an accurate measurement of the process temperature with a calibrated reference thermometer. The measurement error of the reference thermometer should be less than 0.1 K. Adjustment without an accurate measurement of the process temperature may result in falsification of the displayed measured value.

For Memosens sensors, the adjustment value is saved in the sensor.

Calibration Procedure

Calibration ▶ [I] [II] [Sensor]

01. Select "Temperature" Calibration Mode and confirm with **enter**.
02. Enter the measured process temperature and confirm with **enter**.
 - ✓ The temperature offset is displayed.
03. Press **right softkey: Save** to calibrate the temperature detector.

The data of the current adjustment and temperature offset can be opened in the Diagnostics menu:

Diagnostics ▶ [I] [II] [Sensor] ▶ Temp. Offset Log

7.5 Conductivity (Inductive) Process Variable Calibration/Adjustment

- Calibration: Detect deviations without readjustment of calibration data
- Adjustment: Detect deviations with readjustment of calibration data

NOTICE! When using analog sensors, adjustment is required following sensor replacement.

7.5.1 Explanations Regarding Calibration/Adjustment with Toroidal Sensors

Each toroidal conductivity sensor has an individual cell factor. The cell factor may vary depending on the sensor design. Because the conductivity value is calculated from the measured conductance and the cell factor, the measuring system must know the cell factor. During calibration or sensor adjustment, either the known (printed) cell factor of the toroidal conductivity sensor used is entered in the measurement system, or it is determined automatically by measuring a calibration solution with known conductivity.

Notes on Calibration

- Use only fresh calibration solutions. The parameters of the calibration solution used must be set.
- Calibration accuracy of the is crucially dependent on precise acquisition of the calibration solution temperature. Based on the measured or entered temperature, Stratos Multi calculates the setpoint of the calibration solution from a stored table.
- Note the settling time of the temperature probe.
- To determine the cell factor accurately, wait for temperature equalization of the temperature detector and calibration solution before calibration.

Because the cell factor is subject to production-related fluctuations, we recommend calibrating the removed sensor be calibrated with a calibration solution (e.g., saturated NaCl).

- If the installation space is tight (minimum distances are not reached), the sensor must be adjusted in its installed state, as the resulting cell factor has changed.

Calibration Mode : "Product Calibration".

7.5.2 Temperature Compensation during Calibration

The conductivity value of the calibration solution is temperature-dependent. During calibration, the temperature of the calibration solution must therefore be known so that the actual value can be obtained from the conductivity table.

Automatic Temperature Compensation

During automatic logging of the calibration temperature, Stratos Multi measures the temperature of the calibration solution using the temperature detector integrated in the Memosens sensor.

If the sensor does not have an integrated temperature detector:

- Connect an external temperature detector and select it in the Parameter Setting menu.
→ *Channel II Wiring Examples, p. 218*
- Specify the manual temperature for calibration.

The settings are made in the `Temperature Detection` submenu:

`Menu Selection` ▶ `Parameter Settings` ▶ `[II] Analog ...` ▶ `Sensor Data` ▶ `Temperature Detection`

7.5.3 Calibration/Adjustment Options

- Automatic: Automatic with standard calibration solution
- Manual: Manual entry of a calibration solution
- Product: Product calibration (calibration with sampling)
- Zero point: Zero Point Correction
- Installation factor: Entry of an installation factor (with Memosens sensors)
- Data entry: Data entry of premeasured sensors
- Temperature: Temperature detector adjustment

7.5.4 Calibration Mode: Automatic

Automatic Calibration with Standard Calibration Solution

During automatic calibration, the conductivity sensor is immersed in a standard calibration solution (NaCl or KCl, set during parameter setting). Stratos Multi automatically calculates the cell factor on the basis of the measured conductance and temperature. The temperature dependence of the calibration solution is taken into account.

Notes on Calibration

- Use only fresh calibration solutions. The parameters of the calibration solution used must be set.
- Calibration accuracy of the is crucially dependent on precise acquisition of the calibration solution temperature. Based on the measured or entered temperature, Stratos Multi calculates the setpoint of the calibration solution from a stored table.
- Note the settling time of the temperature probe.
- To determine the cell factor accurately, wait for temperature equalization of the temperature detector and calibration solution before calibration.
- If the measured conductance or temperature fluctuate greatly, the calibration procedure is aborted after approx. 2 min. Repeat calibration if an error message appears.

Calibration Procedure

Calibration ▶ [I] [II] ... Condi

When you access calibration, the calibration values selected in the calibration presets are used. These settings can still be changed in the Calibration menu. If you do not want to perform calibration, use the left **softkey** to go back one level and abort the calibration.

01. Select "Automatic" **Calibration Mode** and confirm with **enter**.
 - ✓ Display of calibration solution as configured in **Cal Presettings**. → *Calibration Presettings, p. 90*
 02. Change the calibration solution if necessary.
 03. Take the sensor out of the medium, rinse it well in deionized water, and dry it.
 04. Dip the sensor in the calibration solution.
 05. Start calibration with **right softkey: Next**.
 - ✓ Calibration is performed.
 - The following parameters are displayed: Calibration temperature, solution table value (conductivity depending on calibration temperature), and settling time.
- ✓ The calibration record is displayed. Confirm with **right softkey: Adjust**, the calibration values obtained during calibration for calculation of the process variables are applied to the device. When using a Memosens sensor, the calibration values are saved in the sensor.

7.5.5 Calibration Mode: Manual

Manual Calibration Specifying a Calibration Solution

During calibration with manual entry of the conductivity value of the calibration solution, the sensor is immersed in a calibration solution. Stratos Multi calculates a conductivity/calibration temperature pair value. The temperature-corrected conductivity value of the calibration solution must then be entered. For this purpose, take the conductivity value that goes with the displayed temperature from the calibration solution TC table. Conductivity intermediate values must be interpolated.

Stratos Multi automatically calculated the cell factor.

Notes on Calibration

- Use only fresh calibration solutions. The parameters of the calibration solution used must be set.
- Calibration accuracy of the is crucially dependent on precise acquisition of the calibration solution temperature. Based on the measured or entered temperature, Stratos Multi calculates the setpoint of the calibration solution from a stored table.
- Note the settling time of the temperature probe.
- To determine the cell factor accurately, wait for temperature equalization of the temperature detector and calibration solution before calibration.
- If the measured conductance or temperature fluctuate greatly, the calibration procedure is aborted after approx. 2 min. Repeat calibration if an error message appears.

Calibration Procedure

Calibration ▶ [I] [II] ... Condl

When you access calibration, the calibration values selected in the calibration presettings are used. These settings can still be changed in the Calibration menu. If you do not want to perform calibration, use the left **softkey** to go back one level and abort the calibration.

01. Select "Manual" **Calibration Mode** and confirm with **enter**.
02. Remove the sensor from the medium and rinse it well in deionized water.
03. Dip the sensor in the calibration solution.
04. Start calibration with **right softkey: Next**.
 - ✓ Calibration is performed.
The following parameters are displayed: Calibration temperature and settling time.
05. Enter the conductivity.
06. Continue with **right softkey: Next**.
 - ✓ The calibration record is displayed. Confirm with **right softkey: Adjust**, the calibration values obtained during calibration for calculation of the process variables are applied to the device. When using a Memosens sensor, the calibration values are saved in the sensor.

7.5.6 Calibration Mode: Product

Calibration by Sampling

If the sensor cannot be removed – e.g., for sterility reasons – its cell factor can be determined by “sampling”. The currently measured value (conductivity or concentration¹⁾) of the process is stored by Stratos Multi for this purpose. Immediately afterwards, take a sample from the process. The value of this sample is measured under process conditions (same temperature!) wherever possible. The calculated value is entered in the measuring system. Stratos Multi calculates the cell factor of the conductivity sensor from the deviation between the process measured value and the sample value.

Note: Product calibration can also be carried out via Ethernet.

→ *Product Calibration with Studio 5000 Logix Designer*[®], p. 104

Product Calibration without TC Compensation (With Conductivity)

A sample is taken from the process. The sample's measured value is determined in the laboratory at the temperature at which the sample was taken (“Sample Temperature”, see display). It may be necessary to thermostat the sample in the laboratory accordingly. Temperature compensation of the reference transmitters must be disabled (TC = 0 %/K).

Product Calibration with TC Compensation $T_{ref} = 25\text{ °C}/77\text{ °F}$ (With Conductivity)

A sample is taken from the process. During measurement in the laboratory (TC linear), the same values for reference temperature and temperature coefficient must be set in both the reference transmitter and Stratos Multi. In addition, the measuring temperature should match the sample temperature (see display) as closely as possible. The sample should be transported in a vacuum flask (Dewar) to ensure this.

NOTICE! Product calibration is only possible if the process medium is stable (no chemical reactions that affect conductivity). At higher temperatures, evaporation may falsify results.

Calibration Procedure

Calibration ▶ [I] [II] ... Condi

When you access calibration, the calibration values selected in the calibration presets are used. These settings can still be changed in the Calibration menu. If you do not want to perform calibration, use the left **softkey** to go back one level and abort the calibration.

01. Select “Product” Calibration Mode and confirm with **enter**.
02. Prepare for sampling.
03. Start with **right softkey: Next**.

Product calibration is performed in 2 steps.

Step 1: Sampling [Save]	
Conductivity	1,249 mS/cm
Temperature	23.3°C
Enter Lab Value [Entry]	

Step 1:

04. Take sample.
 - ✓ The measured value and temperature at the time of sampling are displayed.

¹⁾ First enable TAN option FW-E009. → *Concentration Determination (FW-E009)*, p. 187

05. Save with **right softkey: Save**.

✓ An information window is displayed.

06. **Right softkey: Close**

07. If required, exit calibration with the **left softkey: Back**.

Note: The icon  indicates that product calibration has not yet been completed.

Step 2: Lab value is present.

08. Open the Product Calibration menu again.

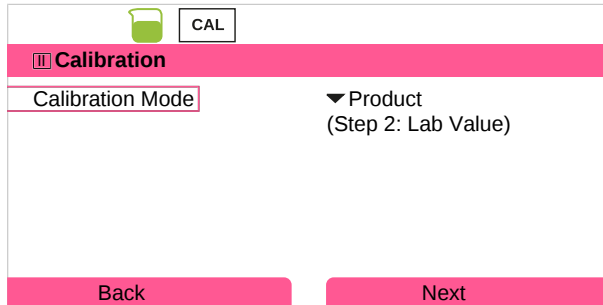

09. **Right softkey: Next**

10. Enter the lab value and confirm with **enter**.

11. Confirm with **right softkey: Next** or repeat calibration with **left softkey: Cancel**.

✓ The calibration record is displayed. Confirm with **right softkey: Adjust**, the calibration values obtained during calibration for calculation of the process variables are applied to the device. When using a Memosens sensor, the calibration values are saved in the sensor.

Exception: Sample value can be determined and immediately entered on site:

12. Take sample.

✓ The measured value and temperature at the time of sampling are displayed.

13. **Left softkey: Entry**

14. Enter the lab value and confirm with **enter**.

15. Confirm with **right softkey: Next** or repeat calibration with **left softkey: Cancel**.

✓ The calibration record is displayed. Confirm with **right softkey: Adjust**, the calibration values obtained during calibration for calculation of the process variables are applied to the device. When using a Memosens sensor, the calibration values are saved in the sensor.

7.5.7 Calibration Mode: Zero Point

Calibration Procedure

Calibration ▶ [I] [II] ... Condl

When you access calibration, the calibration values selected in the calibration presets are used. These settings can still be changed in the Calibration menu. If you do not want to perform calibration, use the left **softkey** to go back one level and abort the calibration.

01. Select "Zero Point" **Calibration Mode** and confirm with **enter**.
02. Take the sensor out of the medium, rinse it in deionized water, and dry it. The sensor must be dry, since zero calibration is performed in air.
03. Press the **right softkey: Next**.
 - ✓ Zero point correction is performed. The permissible zero offset depends on the sensor type.
04. Press the **right softkey: Next**.
 - ✓ The calibration record is displayed. Confirm with **right softkey: Adjust**, the calibration values obtained during calibration for calculation of the process variables are applied to the device. When using a Memosens sensor, the calibration values are saved in the sensor.

Valid for Inductive Conductivity with Memosens Sensors:

The calibration values are displayed following successful zero calibration.

05. Press the **right softkey: Next**.
 - ✓ The message "Adjustment Successful" is displayed.

7.5.8 Calibration Mode: Installation Factor

If using a Memosens sensor in a tight space, enter the installation factor.

Calibration Procedure

Calibration ▶ [I] [II] ... Condl

When you access calibration, the calibration values selected in the calibration presets are used. These settings can still be changed in the Calibration menu. If you do not want to perform calibration, use the left **softkey** to go back one level and abort the calibration.

01. Select "Installation Factor" **Calibration Mode** and confirm with **enter**.
02. Enter the installation factor.
03. Continue with **right softkey: Save**.
 - ✓ The message "Adjustment Successful" is displayed.

7.5.9 Calibration Mode: Data Entry

Enter values for the cell factor and zero point of a sensor, with reference to 25 °C (77 °F)

If concentration measurement is activated (TAN option FW-E009), the concentration is also shown in this menu and directly adjusted with the cell factor. This makes direct calibration to the concentration value possible.

Calibration Procedure

Calibration ▶ [I] [II] ... Condl

When you access calibration, the calibration values selected in the calibration presettings are used. These settings can still be changed in the Calibration menu. If you do not want to perform calibration, use the left **softkey** to go back one level and abort the calibration.

01. Select "Data Entry" Calibration Mode and confirm with **enter**.
02. Remove the sensor and install the pre-measured sensor.
03. Continue with **right softkey: Next**.
04. Enter the cell factor of the pre-measured sensor.

✓ The calibration record is displayed. Confirm with **right softkey: Adjust**, the calibration values obtained during calibration for calculation of the process variables are applied to the device. When using a Memosens sensor, the calibration values are saved in the sensor.

7.5.10 Calibration Mode: Temperature

Adjusting the Temperature Detector

This function is used to adjust the individual tolerance of the temperature detector or cable lengths to increase temperature measurement accuracy.

The adjustment requires an accurate measurement of the process temperature with a calibrated reference thermometer. The measurement error of the reference thermometer should be less than 0.1 K. Adjustment without an accurate measurement of the process temperature may result in falsification of the displayed measured value.

For Memosens sensors, the adjustment value is saved in the sensor.

Calibration Procedure

Calibration ▶ [I] [II] [Sensor]

01. Select "Temperature" Calibration Mode and confirm with **enter**.
02. Enter the measured process temperature and confirm with **enter**.
 - ✓ The temperature offset is displayed.
03. Press **right softkey: Save** to calibrate the temperature detector.

The data of the current adjustment and temperature offset can be opened in the Diagnostics menu:

Diagnostics ▶ [I] [II] [Sensor] ▶ Temp. Offset Log

7.6 Calibration/Adjustment Oxygen Process Variable

- Calibration: Detect deviations without readjustment of calibration data
- Adjustment: Detect deviations with readjustment of calibration data

NOTICE! When using analog sensors, adjustment is required following sensor replacement.

7.6.1 Explanations Regarding Oxygen Calibration/Adjustment

Every oxygen sensor has an individual slope and an individual zero point. Both values change, for example, as a result of aging and wear. To achieve sufficient measurement accuracy for oxygen measurement, the sensor data should be regularly adjusted.

“Slope” is equal to the sensor current value at atmospheric oxygen saturation, 25 °C (77 °F) and 1013 mbar (14.69 psi): nA/100%. Only the “nA” measurement symbol appears on the display. This is technically not a “slope” but instead, a calibration point. The value is provided to enable the sensor to be compared to the data sheet values.

If the electrolyte, the membrane body, or both are replaced during maintenance of amperometric sensors, this change must be confirmed manually in the Maintenance menu:

Maintenance ▶ [I] [II] ... Oxy ▶ Membrane Body Replacement

→ *Channel I/II Maintenance Functions, p. 150*

Calibration is required after each membrane body replacement. This entry has an influence on the accuracy of the calibration.

Recommendations for Calibration

For best performance, you should always calibrate in air. Compared to water, air is an easy to handle, stable calibration solution which is safe. In most cases, however, the sensor must be removed for calibration in air. In certain processes, the sensor cannot be removed for calibration. Here, calibration must be performed directly in the process medium (e.g., with aeration).

For applications where concentration is measured, however, calibration in air has proved to be useful.

Common Process Variable/Calibration Mode Combination

Measurement	Calibration
Saturation:	Water
Concentration:	Air

If there is a temperature difference between the calibration medium and process medium, the sensor must remain in the respective medium for an equalization period before and after calibration in order to obtain stable measured values.

The type of calibration pressure detection is assigned a default value during parameter setting:

Parameter Setting ▶ [I] [II] ... Oxy ▶ Pressure Correction → *Pressure Correction, p. 100*

Note: Amperometric sensors must be sufficiently polarized prior to calibration/adjustment. Follow the information on the sensor in the user manual of the sensor to ensure that the calibration is neither falsified nor unstable.

7.6.2 Calibration/Adjustment Options

- In air/water: Automatic calibration in water/air
- Data entry: Data entry of premeasured sensors
- Product: Product calibration by entering saturation %air, concentration, or partial pressure
- Zero point: Zero correction
- Temperature: Temperature detector adjustment

7.6.3 Calibration Mode: In Air

Automatic calibration in air

The slope is corrected with the saturation value (100% Air), similar to the air saturation of water with air. Since this analogy only applies to water-vapor saturated air (100% relative humidity) but calibration air is often less humid, the relative humidity of the calibration air must also be specified. If the relative humidity of the calibration air is unknown, the following guidelines are valid approximations of sufficiently accurate calibration:

- Ambient air: 50% relative humidity (mean value)
- Bottled gas (synthetic air): 0% relative humidity

Calibration Procedure

Note: The sensor membrane must be dry. Be sure to keep temperature and pressure constant during calibration. If there is a temperature difference between calibration and measured media, the sensor requires some equalization time before and after calibration.

Calibration ▶ [I] [II] ... Oxy

When you access calibration, the calibration values selected in the calibration presettings are used. These settings can still be changed in the Calibration menu. If you do not want to perform calibration, use the left **softkey** to go back one level and abort the calibration.

01. Select "In Air" **Calibration Mode** and confirm with **enter**.
 02. Take the sensor out of the medium and clean it.
 03. Carefully dab the membrane dry with a paper tissue.
 04. Expose the sensor to air with a known water vapor saturation and confirm with **enter**.
 - ✓ Display of the selected calibration solution (air)
 05. Enter relative humidity, e.g.: Ambient air: 50%, bottled gas: 0%
 06. **Enter Cal Pressure** : Enter the calibration pressure if "Manual" was configured.
 07. Start with **right softkey: Next**
 - ✓ Drift check is carried out.
 - The following parameters are displayed: Sensor Current, Calibration Pressure, and Settling Time.
 08. Exit calibration with the **right softkey: Next**.
- ✓ The calibration record is displayed. Confirm with **right softkey: Adjust**, the calibration values obtained during calibration for calculation of the process variables are applied to the device. When using a Memosens sensor, the calibration values are saved in the sensor.

7.6.4 Calibration Mode: In Water

Automatic Calibration in Water

The slope is corrected with the saturation value (100 %) related to saturation with air.

Calibration Procedure

Note: Ensure sufficient sensor incident flow. (See the oxygen sensor specifications.) The calibration solution must be in equilibrium with air. Oxygen exchange between water and air is very slow. Therefore, it takes a relatively long time for water to become saturated with atmospheric oxygen. If there is a temperature difference between the calibration solution and process medium, the sensor requires an equalization time of several minutes before and after calibration.

Calibration ▶ [I] [II] ... Oxy

When you access calibration, the calibration values selected in the calibration presets are used. These settings can still be changed in the Calibration menu. If you do not want to perform calibration, use the left **softkey** to go back one level and abort the calibration.

01. Select "In Water" **Calibration Mode** and confirm with **enter**.
02. Take the sensor out of the medium and clean it.
03. Carefully dab the membrane dry with a paper tissue.
04. Expose the sensor to the calibration solution (air-saturated water), ensure sufficient incident flow, and confirm with **enter**.
 - ✓ Display of selected calibration solution (air-saturated water)
05. **Enter Cal Pressure** : Enter the calibration pressure if "Manual" was configured.
06. Start with **right softkey: Next**.
 - ✓ Drift check is carried out.

The following parameters are displayed: Sensor Current, Calibration Pressure, and Settling Time.

The time for the sensor signal to stabilize can be shortened with the **left softkey: Exit** (without drift check: reduced accuracy of calibration values). The settling time indicates how long the sensor needs until the sensor signal is stable. If the sensor signal or the measured temperature fluctuate considerably or the sensor is inadequately polarized, the calibration procedure is aborted after around 2 minutes. In this case, calibration needs to be restarted. Return the sensor to the process once this has been successfully completed. Make sure that the temperature of the sensor and the temperature of the calibration solution are not too far apart. The ideal temperature is 25 °C/77 °F.
07. Exit calibration with the **right softkey: Next**.
 - ✓ The calibration record is displayed. Confirm with **right softkey: Adjust**, the calibration values obtained during calibration for calculation of the process variables are applied to the device. When using a Memosens sensor, the calibration values are saved in the sensor.

7.6.5 Calibration Mode: Data Entry

Entry of values for slope and zero point of the sensor, related to 25 °C/77 °F, 1013 mbar/14.69 psi.

Slope = sensor current at 100% atmospheric oxygen, 25 °C/77 °F, 1013 mbar (14.69 psi)

Calibration Procedure

Calibration ▶ [I] [II] ... Oxy

When you access calibration, the calibration values selected in the calibration presettings are used. These settings can still be changed in the Calibration menu. If you do not want to perform calibration, use the left **softkey** to go back one level and abort the calibration.

01. Select "Data Entry" Calibration Mode and confirm with **enter**.
02. Remove the sensor and install the pre-measured sensor.
03. Continue with **right softkey: Next**.
04. Enter measured values for the zero point and slope, and confirm with **enter**.

✓ The calibration record is displayed. Confirm with **right softkey: Adjust**, the calibration values obtained during calibration for calculation of the process variables are applied to the device. When using a Memosens sensor, the calibration values are saved in the sensor.

7.6.6 Calibration Mode: Product

Calibration by Sampling

If the sensor cannot be removed – e.g., for sterility reasons – its slope can be determined by "sampling". The current "Saturation" measured value is saved in the device for this purpose. A sample is taken directly afterward at the measuring point. The reference value is entered in the device. Stratos Multi calculates the correction values of the sensor from the difference between the measured value and reference value, and corrects the zero point for small saturation values and the slope for large values.

Note: Product calibration can also be carried out via Ethernet.

→ *Product Calibration with Studio 5000 Logix Designer*[®], p. 104

Calibration Procedure

NOTICE! Measure the reference value at temperature and pressure conditions similar to those of the process.

Calibration ▶ [I] [II] ... Oxy

When you access calibration, the calibration values selected in the calibration presettings are used. These settings can still be changed in the Calibration menu. If you do not want to perform calibration, use the left **softkey** to go back one level and abort the calibration.

01. Select "Product" Calibration Mode and confirm with **enter**.
 - ✓ The process variables Saturation, Concentration, and Partial Pressure are configured as in Cal Presettings. → *Calibration Presettings*, p. 100
02. Change the process variable, if required.
03. Prepare for sampling.
04. Start with **right softkey: Next**.

Product calibration is performed in 2 steps.

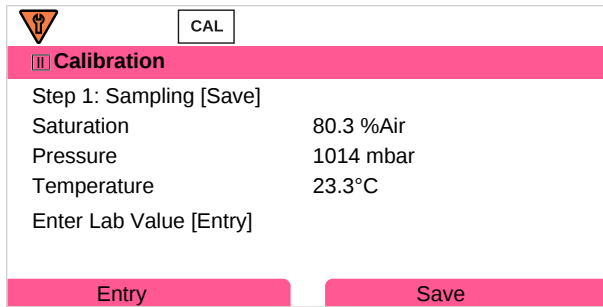

Step 1:

05. Take sample.

✓ The measured value and temperature at the time of sampling are displayed.

06. Save with **right softkey: Save**.

✓ An information window is displayed.

07. **Right softkey: Close**

08. If required, exit calibration with the **left softkey: Back**.

Note: The icon  indicates that product calibration has not yet been completed.

Step 2: Lab value is present.

09. Open the Product Calibration menu again.

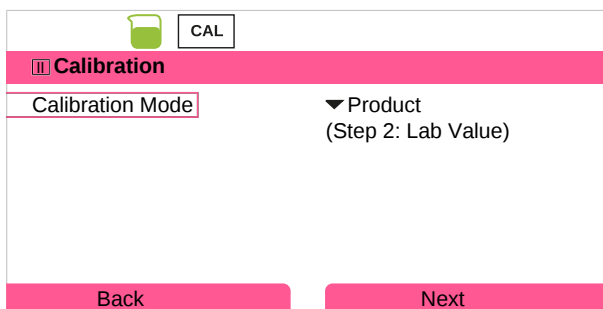

10. **Right softkey: Next**

11. Enter the lab value and confirm with **enter**.

12. Confirm with **right softkey: Next** or repeat calibration with **left softkey: Cancel**.

✓ The calibration record is displayed. Confirm with **right softkey: Adjust**, the calibration values obtained during calibration for calculation of the process variables are applied to the device. When using a Memosens sensor, the calibration values are saved in the sensor.

Exception: Sample value can be determined and immediately entered on site:

13. Take sample.

✓ The measured value and temperature at the time of sampling are displayed.

14. **Left softkey: Entry**

15. Enter the lab value and confirm with **enter**.

16. Confirm with **right softkey: Next** or repeat calibration with **left softkey: Cancel**.

✓ The calibration record is displayed. Confirm with **right softkey: Adjust**, the calibration values obtained during calibration for calculation of the process variables are applied to the device. When using a Memosens sensor, the calibration values are saved in the sensor.

7.6.7 Calibration Mode: Zero Point

Zero Point Correction

For trace measurements below 500 ppb, we recommend calibrating the zero point. (TAN option FW-E015, "Oxygen Measurement in Low Oxygen Concentrations")

If a zero point correction is performed, the sensor should remain in the calibration solution for 10 ... 60 min or more (media containing CO₂ should remain for 120 min or more), in order to obtain a stable, drift-free values. During zero point correction, the device does not do a drift check.

Calibration Procedure

Calibration ▶ [I] [II] ... Oxy

When you access calibration, the calibration values selected in the calibration presets are used. These settings can still be changed in the Calibration menu. If you do not want to perform calibration, use the left **softkey** to go back one level and abort the calibration.

01. Select "Zero Point" Calibration Mode and confirm with **enter**.
02. Press **right softkey: Next**.
 - ✓ Zero point correction is performed. The measured sensor current is shown.
03. Enter the input current for the zero point.
04. Press **right softkey: Next**.
 - ✓ The calibration record is displayed. Confirm with **right softkey: Adjust**, the calibration values obtained during calibration for calculation of the process variables are applied to the device. When using a Memosens sensor, the calibration values are saved in the sensor.

7.6.8 Calibration Mode: Temperature

Adjusting the Temperature Detector

This function is used to adjust the individual tolerance of the temperature detector or cable lengths to increase temperature measurement accuracy.

The adjustment requires an accurate measurement of the process temperature with a calibrated reference thermometer. The measurement error of the reference thermometer should be less than 0.1 K. Adjustment without an accurate measurement of the process temperature may result in falsification of the displayed measured value.

For Memosens sensors, the adjustment value is saved in the sensor.

Calibration Procedure

Calibration ▶ [I] [II] [Sensor]

01. Select "Temperature" Calibration Mode and confirm with **enter**.
02. Enter the measured process temperature and confirm with **enter**.
 - ✓ The temperature offset is displayed.
03. Press **right softkey: Save** to calibrate the temperature detector.

The data of the current adjustment and temperature offset can be opened in the Diagnostics menu:

Diagnostics ▶ [I] [II] [Sensor] ▶ Temp. Offset Log

8 Diagnostics

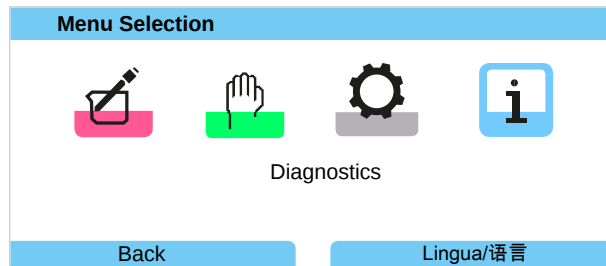

Diagnostic functions can be directly opened from the measuring mode with the **right softkey**. To do this, the Favorites menu function must be assigned to the **Softkey (1)**:

Parameter Setting ▶ System Control ▶ Function Control → *Function Control, p. 45*

8.1 Diagnostics Functions

The diagnostic functions are based on NAMUR Recommendation NE 107.

8.1.1 Overview of Diagnostic Functions

In diagnostics mode, you can open the following submenus without interrupting the measurement process:

Submenu	Description
Message List	Shows currently active messages in plain text. → <i>Message List, p. 144</i>
Logbook	Shows the last 100 events with date and time, e.g., calibrations, warning and failure messages, power failure, etc. With TAN option FW-E104, 20,000 entries or more can be recorded on a memory card (Data Card). → <i>Logbook, p. 145</i>
Device Information	Display of device information: device type, serial number, hardware/firmware version → <i>Device Information, p. 145</i>
Network Information	Displays the current IP and MAC addresses → <i>Diagnostics, p. 108</i>
EtherNet/IP Monitor	Displaying the Current AI, AO, DO Values → <i>Diagnostics, p. 108</i>
Measurement Recorder	With activated measurement recorder (TAN option FW-E103): Graphical display of the recorded measured values → <i>Measurement Recorder (FW-E103), p. 201</i>
Device Test	Display of device diagnostics and execution of a display or keypad test → <i>Device Test, p. 146</i>
Meas. Point Description	Display tag number and annotation. → <i>Measuring Point Description, p. 146</i>
[I] [II] [Sensor]	Depending on the sensor type, e.g., sensor information, sensor monitor, sensor diagram, calibration/adjustment record → <i>Channel I/II Diagnostic Functions, p. 147</i>

8.1.2 Message List

All values determined by the measuring module or sensor can generate messages.

Displaying Messages

Diagnostics ▶ Message List

All active messages are displayed with the following information: Message number, type (Failure, Maintenance Required, Out of Specification), channel, message text.

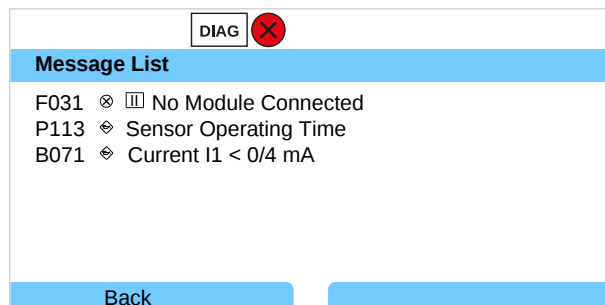

You can scroll forwards and backwards with the *up/down arrow keys*.

You will find an overview of message texts with notes on troubleshooting in the “Troubleshooting” chapter. → *Messages, p. 155*

The error message disappears from the display around 2 s after troubleshooting.

Setting Parameters for Messages

Individual process variable limits for the monitoring range can be selected in the **Messages** submenu:

Parameter Setting ▶ [I] [II] [Sensor] ▶ Messages ▶ Messages [Process Variable] ▶ Monitoring

- Max. Device Limits: Messages are generated when the process variable is outside the measuring range. The “failure” or “out of specification” icons are shown; the corresponding relay contact is enabled. The current outputs can signal a 22 mA message (user-defined).
- Variable Limits: Upper and lower limits at which a message is generated can be defined for the “Failure” and “Out of Specification” messages.

Note: If display color NE107 is selected in Parameter Setting (factory setting), measured values are backlit in accordance with their NAMUR color when NAMUR messages are available.

Parameter Setting ▶ General ▶ Display

8.1.3 Logbook

The logbook displays the last 100 events with message number, date, and time directly on the device, e.g., calibrations, NAMUR messages, power failure. Messages generated during function check mode (HOLD) are not saved.

Open under: **Diagnostics** ▶ **Logbook**

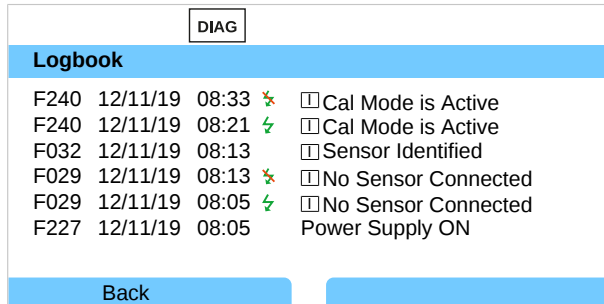

You can scroll forwards and backwards in the logbook with the *up/down arrow keys*.

When using the Data Card and TAN option FW-E104, 20,000 entries or more can be recorded on the Data Card. → *Logbook (FW-E104), p. 203*

In the system control, select whether failure and/or maintenance required messages should be recorded in the logbook:

Parameter Setting ▶ **System Control** ▶ **Logbook** → *Logbook, p. 47*

Logbook entries can also be deleted here.

8.1.4 Device Information

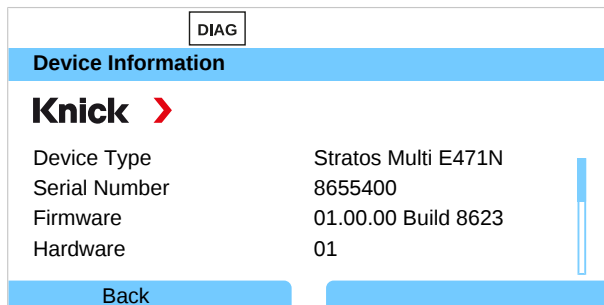

The following device information is displayed for the basic unit and any connected module:

- Device type
- Serial number
- Firmware versions
- Hardware versions
- Bootloader

Open under: **Diagnostics** ▶ **Device Information**

8.1.5 Device Test

Device Diagnostics

Stratos Multi periodically performs a self-test in the background.

The results can be viewed in [Diagnostics](#) ▶ [Device Test](#) ▶ [Device Diagnostics](#)

If a memory card is inserted, the card type and available memory are also displayed.

DIAG	
Device Diagnostics	
Internal Communication	OK
Real-Time Clock	OK
Flash Checksum	OK
Memory Card	Data, 32 MB
Back Back to Meas.	

Display test

If you select [Diagnostics](#) ▶ [Device Test](#) ▶ [Device Diagnostics](#) the device performs a display test. The display changes color from red to green to blue.

Keypad test

You can test the device keypad by selecting [Diagnostics](#) ▶ [Device Test](#) ▶ [Keypad Test](#).

01. Press all keys one after the other.

✓ A green checkmark shows that a key functions properly.

02. Press the *left softkey* to exit.

8.1.6 Measuring Point Description

[Diagnostics](#) ▶ [Meas. Point Description](#)

Display the tag number and annotation

Entry in the [Parameter Setting](#) ▶ [System Control](#) ▶ [Meas. Point Description](#)

→ *Measuring Point Description*, p. 46

8.1.7 Channel I/II Diagnostic Functions

The submenus vary depending on the sensor type. Key functions are set out below.

Sensor Information

The Sensor Information submenu shows data from the currently connected digital sensor, e.g., manufacturer, order no., serial no., firmware and hardware version, last calibration, operating time:

Diagnostics ▶ [I] [II] [Sensor] ▶ Sensor Information

Sensor Monitor

For diagnostic purposes, the raw measured values for the sensor type are displayed in the sensor monitor.

Diagnostics ▶ [I] [II] [Sensor] ▶ Sensor Monitor

Sensor Diagram

Note: Function active for pH and oxygen sensors.

The sensor diagram shows the state of the parameters of the connected sensor, including the calibration timer, at a glance.

Inactive parameters are shown in gray and set to 100% (e.g., disabled calibration timer).

The parameter values should be between the outer (100%) and inner (50%) polygon. If a value falls below the inner polygon (< 50%), a warning signal flashes.

Open under: Diagnostics ▶ [I] [II] [Sensor] ▶ Sensor Diagram

Example display:

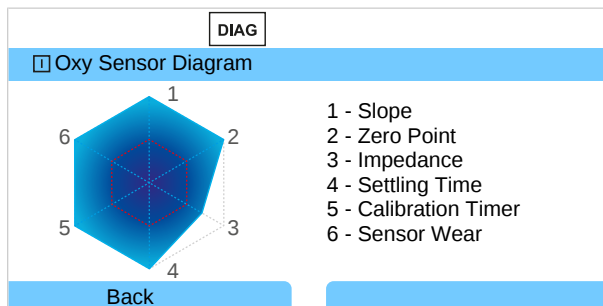

The tolerance limits (radius of the "inner circle") can be changed as required:

Parameter Setting ▶ [I] [II] [Sensor] ▶ Sensor Data ▶ Sensor Monitoring Details

Calibration/Adjustment Record

The calibration/adjustment record shows the data from the last calibration/adjustment performed on the currently connected sensor.

Open under: Diagnostics ▶ [I] [II] [Sensor] ▶ Cal/Adj Record [Process Variable]

Temp. Offset Log

The temp. offset log shows the data from the last temperature equalization performed on the currently connected sensor.

Open under: Diagnostics ▶ [I] [II] [Sensor] ▶ Temp. Offset Log

Sensor Wear Monitor

The sensor wear monitor shows the sensor operating time and maximum temperature during the operating time, as well as wear and the estimated remaining time. For oxygen sensors, the number of membrane replacements and calibrations is also displayed:

Diagnosics ▶ [I] [II] [Sensor] ▶ Sensor Wear Monitor

DIAG

Sensor Wear Monitor

Operating Time	68 d
Wear	9.5%
Remaining Lifetime	661 d
Max. Temperature	32°C

Back
Back to Meas.

Load Matrix

Note: Function active for ISM pH/ORP sensors and amperometric ISM oxygen sensors.

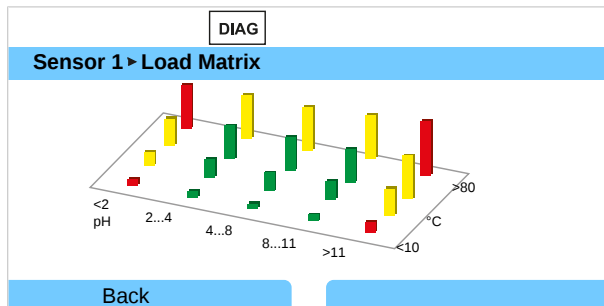

Bar color

- | | |
|---------|--|
| Green: | The area that puts the least load on the sensor. |
| Yellow: | The area that puts more load on the sensor. |
| Red: | The area that puts the most load on the sensor. |

The bar height indicates the duration of the load.

See also

→ *Digital ISM-Sensors (FW-E053), p. 198*

Statistics

Note: Function active for ISM pH/ORP sensors and amperometric ISM oxygen sensors.

The statistics data provides information on the sensor product life cycle: Data from the first adjustment and the three most recent calibrations/adjustments is displayed. This data can be used to assess the performance of the sensor over its operating period.

Use the **right softkey** to switch between a graphical display and a list.

See also

→ *Digital ISM-Sensors (FW-E053), p. 198*

→ *Calibration/Adjustment, p. 112*

9 Maintenance Functions

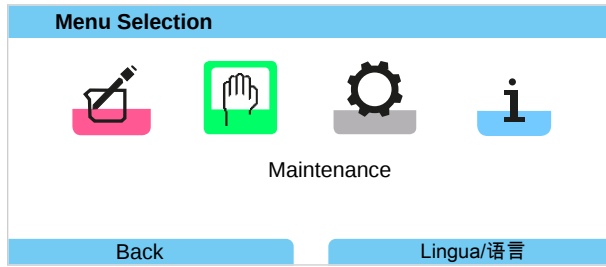

Note: Function check (HOLD) is active. EtherNet/IP communication and the relay contacts or the current outputs behave in accordance with the parameter settings. Return to measuring mode to exit the function check, e.g., with the **right softkey: Back to Meas.**

9.1 Overview of Maintenance Functions

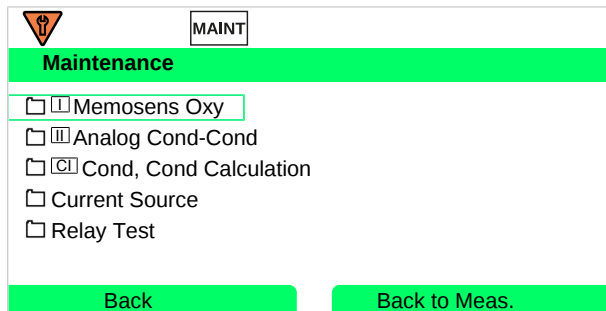

The maintenance menu provides different functions for checking the device function:

Submenu	Description
Open/Close Memory Card	Only with connected Data Card → <i>Memory Card, p. 181</i>
[I] [II] [Sensor]	Depending on sensor type, e.g.: Sensor Monitor → <i>Channel I/II Maintenance Functions, p. 150</i>
[CI] [CII] Cond, Cond Calculation	When using the Cond/Cond Calculation Block to calculate the pH value before and after an ion exchanger: Confirm ion exchanger replacement. → <i>Calculation Blocks (FW-E020), p. 194</i>
Current Source	Function test: manual control of current outputs in the complete area → <i>Current Source, p. 151</i>
Relay Test	Function test of relay contacts → <i>Relay Test, p. 151</i>

9.2 Channel I/II Maintenance Functions

	Memosens/Analog pH/Cond/Condl	Memosens Oxy	SE740	ISM Oxy ¹⁾	ISM pH ¹⁾
Sensor Monitor	+	+	+	+	+
Autoclaving Counter	+ ²⁾		+	+	+
Membrane Body Replacement		+		+	
Interior Body Replacement				+	

9.2.1 Sensor Monitor

Maintenance ▶ [I] [II] [Sensor] ▶ Sensor Monitor

Display of ongoing measured values (sensor monitor) when function check (HOLD state) is active at the same time:

Because the device is in function check (HOLD) mode, certain media can be used to validate the sensor and check the measured values without influencing the signal outputs.

9.2.2 Autoclaving Counter

If the autoclaving counter has been enabled in the Parameter Setting menu

Sensor Data ▶ Sensor Monitoring Details, it must be manually incremented in the Maintenance menu after each autoclaving process:

01. Maintenance ▶ [I] [II] [Sensor] ▶ Autoclaving Counter
02. **Right softkey:** Cycles+1
03. A confirmation prompt appears: Select "Yes" with the **left arrow key**.
04. Close the window by pressing the **right softkey**.

9.2.3 Electrolyte Replacement/Membrane Body Replacement

If the electrolyte or membrane body of a Memosens oxygen sensor is replaced during sensor maintenance, this must be manually confirmed in the Maintenance menu.

01. Maintenance ▶ [I] [II] Memosens Oxy ▶ Membrane Body Replacement
✓ A text window opens: "Membrane Body or Electrolyte Replaced?"
02. **Left arrow key:** "Yes"
03. Confirm with **enter**.

After the check is confirmed, the counter is automatically reset.

Note: The digital SE740 optical oxygen sensor automatically recognizes replacement of the membrane body. The counter is automatically incremented.

¹⁾ With TAN option FW-E053

²⁾ Only for Memosens pH/ORP

9.2.4 Replacing the Membrane Body/Interior Body

If the membrane body or interior body of an ISM oxygen sensor is replaced during sensor maintenance, this must be manually confirmed in the Maintenance menu.

01. Maintenance ▶ [I] ISM Oxy ▶ Membrane Body Replacement / Interior Body Replacement
02. Enter the date and serial number with the *arrow keys*.
03. Confirm each entry with *enter*.
04. *Right softkey: Apply*

The maximum permitted number of membrane body/interior body replacements can be specified in the parameter settings.

Parameter Setting ▶ [II] ISM Oxy ▶ Sensor Data ▶ Sensor Monitoring Details

9.3 Manual Function Test

9.3.1 Current Source

The output current can be manually specified for the function test (range 0 ... 22 mA):

Maintenance ▶ Current Source

01. Select the current output.
02. Use the *arrow keys* to enter a valid current value for the corresponding output.
03. Confirm with *enter*.
 - ✓ The actual output current is displayed on the bottom right line for checking.

9.3.2 Relay Test

Maintenance ▶ Relay Test

When the menu is opened, the function of the relay contacts (relays) is checked. To check the wiring, the relays can be manually switched.

10 Maintenance

Maintenance

Stratos Multi does not require maintenance.

If maintenance is required at the measuring point (e.g., sensor replacement), function check mode (HOLD) must be activated in the device's Maintenance menu. This can also be done in the Parameter Settings menu (Operator or Administrator level).

Repair

Users cannot repair Stratos Multi and the modules. Please direct your repair requests to Knick Elektronische Messgeräte GmbH & Co. KG at www.knick-international.com.

11 Decommissioning

11.1 Disposal

To dispose of the product properly, follow the local regulations and laws.

Customers can return their electrical and electronic waste devices.

For details on how to return and dispose of electrical and electronic devices in an environmentally friendly manner, please refer to the manufacturer's declaration on our website. If you have any queries, suggestions, or questions about how Knick recycles electrical and electronic waste devices, please send us an email: → support@knick.de

11.2 Return Delivery

If a product must be returned, send it to the responsible local representative in a clean condition and securely packaged. → knick-international.com

12 Troubleshooting



12.1 Failure Conditions

Messages and errors are displayed with the corresponding NAMUR icon and the measured value display of the corresponding channel changes color.

The message is recorded in the logbook with the date and time. → *Logbook, p. 145*

If messages are wired to current outputs or relay contacts, they are activated after the set delay time has elapsed.

Displaying Messages

- Switch to the Diagnostics menu if the “Failure” , “Maintenance Required”  or “Out of Specification”  icons are flashing on the display: [Menu Selection](#) ▶ [Diagnostics](#) ▶ [Message List](#)
 ✓ All active messages are displayed in the [Message List](#) menu item with the following information: Error number, type (Failure, Maintenance Required, Out of Specification), channel, message text.

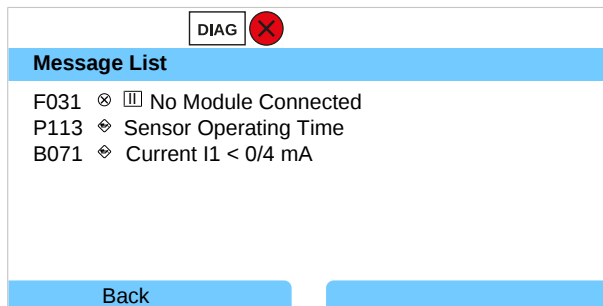

- You can scroll forwards and backwards with the *up/down arrow keys*.





The error message disappears from the display around 2 s after troubleshooting.

Note: The message is deleted from the message list around 2 s after troubleshooting.

General Errors

Error	Possible Cause	Remedy
Display is blank	No power supply	Check the power supply or provide a suitable power supply for the device.
	Display auto-off activated.	Press any key to wake the display following a possible auto-off.
No measured value, no error message	Sensor or module incorrectly connected.	Check the sensor connection/install the module properly.
	Measurement display not configured.	Set the measurement display parameters: Parameter Setting ▶ General ▶ Measurement Display
No connection via EtherNet/IP	RJ45 connector not correctly connected.	Check the RJ45 connection.
	The device cannot be reached via the network.	Ping the device in the local network.

12.2 Messages

Message Type	Display Color in Accordance with NE107
 Failure	Red
 Maintenance Required	Blue
 Out of Specification	Yellow
 Function check	Orange
Info	Info text, appears directly in the relevant menu.
par	Message type is adjustable: Failure or Maintenance Required

The colored display backlighting can be switched off: [Parameter Setting](#) ▶ [General](#) ▶ [Display](#)

Signaling via relay contacts → *Relay Contacts*, p. 58

System Control/General

No.	Type	Message Text	Possible Cause	Remedy
F008	⊗	Adjustment Data	Error in the adjustment data	Disable device (approx. 10 s). If the message persists, send in the device.
F009	⊗	Firmware Error	Error in the firmware	Disable device (approx. 10 s). Re-load the firmware. → <i>Firmware Update (FW-E106)</i> , p. 204 If the message persists, send in the device.
F010	⊗	Failed to Restore Factory Settings		
F029	⊗	No Sensor Connected	The sensor is not identified.	Check connections. Check cable, replace as required. Check sensor, replace as required.
F030	⊗	Wrong Sensor Connected	The connected digital sensor does not match the parameter settings.	Connect the right sensor. Adjust the process variable. → <i>Sensor Selection [I] [II]</i> , p. 63
F031	⊗	No Module Connected	No module is identified. No module or wrong module is connected. Defective module.	Properly install the module and select it in the parameter settings. Replace module.
F032	Info	Sensor Identified	A Memosens sensor was connected.	
F033	Info	Sensor Removed	Sensor is no longer found. Sensor was removed. Defective connections/cables.	Connect the right sensor and adjust the parameter settings if required. Check connections/cables, replace if required.
F034	Info	Module Identified	A new module was inserted.	
F035	Info	Module Removed	Module is no longer found. Module was removed. Defective connections/cables.	Insert the right module and adjust the parameter settings if required. Check connections/cables, replace if required.
F036	⊗	Sensor Devaluated	Digital sensor devaluated.	Replace sensor.

No.	Type	Message Text	Possible Cause	Remedy
F037		Firmware Update Required	Firmware is obsolete.	Update the firmware. → <i>Firmware Update (FW-E106)</i> , p. 204
F038		Sensor Defective	Sensor defective.	Replace sensor.
F039	Info	Door Open	Enclosure incorrectly mounted.	Check enclosure, tighten enclosure screws if required. → <i>Mounting the Enclosure</i> , p. 17
F081	Info	Activation Denied	Wrong TAN entered during option activation.	Verify entry.
F190	Info	Meas. Recorder Full	The memory of the measurement recorder is full.	Delete measurement recorder data or save to Data Card. → <i>Measurement Recorder (FW-E103)</i> , p. 201
F200		Configuration Data Loss Param.	Data error in the parameter settings	Reset to factory settings and set completely new parameters.
F201		KBUS Error	Internal communication error	Disable device (approx. 10 s). If the message persists, send in the device.
F202		System Failure	Internal system error	Disable device (approx. 10 s). If the message persists, send in the device.
F203		Inconsistent Parameter Setting	The parameter settings of the measuring channel operating mode are inconsistent.	Check and correct the parameter settings.
F204		Configuration Data Loss System Control	Data error in the parameter settings	Reset to factory settings and set completely new parameters.
F206		Communication BASE		
F207		Message List Full	Too many messages on the message list	Open message list and remedy error states displayed.
F208		Too Many Sensors Configured	Parameters were set for more sensors than are connected.	Either change parameter settings or connect relevant sensors.
F211		Memory Card		
F212		Time/Date	The time and date not set yet.	Set the time and date: Parameter Setting ▶ System Control ▶ Time/Date
F215		Memory Card Full	The memory card is full.	Replace memory card or delete data.
F227	Info	Power Supply ON	Device was connected to the power supply (logbook entry).	
F228	Info	Firmware Update	A firmware update was performed (logbook entry).	
F229	Info	Wrong Passcode	An incorrect passcode was entered.	Enter the correct passcode. → <i>Passcode Entry</i> , p. 48
F230	Info	Factory Setting	The device was reset to factory settings (logbook entry).	

Current Output/Relay Contacts

No.	Type	Message Text	Possible Cause	Remedy
B001	⊗	Configuration Data Loss	Data error in the parameter settings	Completely reconfigure the device.
B070	↔	Current I1 Span	Current output 1: The selected span is too small/too big.	Parameter Setting ▶ Inputs/Outputs ▶ Current Outputs ▶ Current Output I1 Verify start/end.
B071	↔	Current I1 < /4 mA	Output current I1 is below the permissible limit.	Set current output I1 to 4 ... 20 mA. Parameter Setting ▶ Inputs/Outputs ▶ Current Outputs ▶ Current Output I1 ▶ Output
B072	↔	Current I1 > 20 mA	Output current I1 is above the permissible limit.	Set current output I1 to 4 ... 20 mA. Parameter Setting ▶ Inputs/Outputs ▶ Current Outputs ▶ Current Output I1 ▶ Output
B073	⊗	Current I1 Load Error	Current output 1: The current loop is interrupted (cable break-age) or the load is too high.	Check current loop. Deactivate or short-circuit unused current outputs.
B074	↔	Current I1 Parameter	Faulty parameter setting for current output I1	Check parameter settings: Parameter Setting ▶ Inputs/Outputs ▶ Current Outputs ▶ Current Output I1 ▶ Output
B075	↔	Current I2 Span	Current output 2: The selected span is too small/too big.	Parameter Setting ▶ Inputs/Outputs ▶ Current Outputs ▶ Current Output I2 Verify start/end.
B076	↔	Current I2 < 0/4 mA	Output current I2 is below the permissible limit.	Set current output I2 to 4 ... 20 mA. Parameter Setting ▶ Inputs/Outputs ▶ Current Outputs ▶ Current Output I2 ▶ Output
B077	↔	Current I2 > 20 mA	Output current I2 is above the permissible limit.	Set current output I2 to 4 ... 20 mA. Parameter Setting ▶ Inputs/Outputs ▶ Current Outputs ▶ Current Output I2 ▶ Output
B078	⊗	Current I2 Load Error	Current output 2: The current loop is interrupted (cable break-age) or the load is too high.	Check current loop. Deactivate or short-circuit unused current outputs.
B079	↔	Current I2 Parameter	Faulty parameter setting for current output I2	Check parameter settings: Parameter Setting ▶ Inputs/Outputs ▶ Current Outputs ▶ Current Output I2
B100	Info	Current: Manual Control	Function test of current outputs	
B101	Info	Relay: Manual Control	Function test of relay contacts	
B200	⚠	Rinse Contact Active		
B201	⚠	Function Check via Input		

No.	Type	Message Text	Possible Cause	Remedy
B220	⊗	Flow LO	Value below configured monitoring limit.	Check configured monitoring limit, adjust if required: Inputs/Outputs ▶ Control Inputs ▶ Flow Check process.
B221	⊗	Flow HI	Value above configured monitoring limit.	Check configured monitoring limit, adjust if required: Inputs/Outputs ▶ Control Inputs ▶ Flow Check process.

pH, ORP

No.	Type	Message Text	Possible Cause	Remedy
P001	⊗	Configuration Data Loss	Data error in the parameter settings	Completely reconfigure the device.
P008	⊗	Adjustment Data	Error in the adjustment data	Disable device (approx. 10 s). If the message persists, send in the device.
P009	⊗	Firmware Error	Error in the firmware	Disable device (approx. 10 s). Re-load the firmware. → <i>Firmware Update (FW-E106)</i> , p. 204 If the message persists, send in the device.
P010	⊗	pH Range	Value above/below measuring range. Sensor connected incorrectly or not at all. Sensor, sensor cable or temperature detector defective. With module MK-PH015: Incorrect temperature detector selected. With MK-PH015 module without connection to solution ground: No jumper between terminals B and C.	Check measuring range, adjust if required. Check sensor connection. Connect sensor if required. Check sensor, cable, and temperature detector, replace if required. Select temperature detector used: Parameter Setting ▶ [II] Analog pH ▶ Sensor Data ▶ Temperature Detection Insert jumper between terminals B and C. → <i>pH Analog Wiring Examples</i> , p. 218
P011	⊗	pH LO_LO	Value below configured monitoring limit.	
P012	⚠	pH LO	Value below configured monitoring limit.	
P013	⚠	pH HI	Value above configured monitoring limit.	
P014	⊗	pH HI_HI	Value above configured monitoring limit.	
P015	⊗	Temperature Range	Value above/below measuring range. Sensor connected incorrectly or not at all. Sensor, sensor cable or temperature detector defective. With module MK-PH015: Incorrect temperature detector selected.	Check measuring range, adjust if required. Check sensor connection. Connect sensor if required. Check sensor, cable, and temperature detector, replace if required. Select temperature detector used: Parameter Setting ▶ [II] Analog pH ▶ Sensor Data ▶ Temperature Detection

No.	Type	Message Text	Possible Cause	Remedy
P016	⊗	Temperature LO_LO	Value below configured monitoring limit.	
P017	⚠	Temperature LO	Value below configured monitoring limit.	
P018	⚠	Temperature HI	Value above configured monitoring limit.	
P019	⊗	Temperature HI_HI	Value above configured monitoring limit.	
P020	⊗	ORP Range	Value above/below measuring range.	Check measuring range, adjust if required.
			No ORP sensor connected, sensor incorrectly connected.	Check sensor connection. Connect ORP sensor if required.
			Sensor or sensor cable defective.	Check sensor and cables, replace if required.
			For pH measurement with module MK-PH015: No jumper between terminals B and C.	Insert jumper between terminals B and C. → <i>pH Analog Wiring Examples, p. 218</i>
P021	⊗	ORP LO_LO	Value below configured monitoring limit.	
P022	⚠	ORP LO	Value below configured monitoring limit.	
P023	⚠	ORP HI	Value above configured monitoring limit.	
P024	⊗	ORP HI_HI	Value above configured monitoring limit.	
P025	⊗	rH Range	Value above/below measuring range.	Check measuring range, adjust if required.
			No pH/ORP combo sensor connected, sensor incorrectly connected.	Check sensor connection. Connect pH/ORP combo sensor if required.
			Sensor or sensor cable defective.	Check sensor and cables, replace if required.
P026	⊗	rH LO_LO	Value below configured monitoring limit.	
P027	⚠	rH LO	Value below configured monitoring limit.	
P028	⚠	rH HI	Value above configured monitoring limit.	
P029	⊗	rH HI_HI	Value above configured monitoring limit.	
P045	⊗	pH Voltage Range	Value above/below measuring range.	Check measuring range, adjust if required.
			Sensor connected incorrectly or not at all.	Check sensor connection. Connect sensor if required.
			Sensor or sensor cable defective.	Check sensor and cables, replace if required.
P046	⊗	pH Voltage LO_LO	Value below configured monitoring limit.	
P047	⚠	pH Voltage LO	Value below configured monitoring limit.	
P048	⚠	pH Voltage HI	Value above configured monitoring limit.	
P049	⊗	pH Voltage HI_HI	Value above configured monitoring limit.	

No.	Type	Message Text	Possible Cause	Remedy
P060	par	Sensoface: Slope	☹️ Faulty calibration/adjustment or worn/defective sensor. ☹️ Sensor soon worn.	Calibrate/adjust sensor, check for correct buffer solutions and temperature. Replace sensor if required. Replace sensor soon.
P061	par	Sensoface: Zero Point	☹️ Faulty calibration/adjustment or worn/defective sensor. ☹️ Sensor soon worn.	Calibrate/adjust sensor, check for correct buffer solutions and temperature. Replace sensor if required. Replace sensor soon.
P062	par	Sad Sensoface: Ref Imp.	Reference impedance outside limits Sensor or sensor cable defective. With MK-PH015 module without connection to solution ground: No jumper between terminals B and C.	Check sensor and cables, replace if required. Insert jumper between terminals B and C. → <i>pH Analog Wiring Examples, p. 218</i>
P063	par	Sad Sensoface: Glass Imp.	Glass impedance outside limits Sensor calibration/adjustment overdue. Sensor or sensor cable defective.	Calibrate/adjust sensor. Check sensor and cables, replace if required.
P064	par	Sad Sensoface: Settling Time	Settling time too long. Sensor calibration/adjustment overdue. Faulty calibration.	Calibrate/adjust sensor. Repeat calibration/adjustment.
P065	⊗	Sad Sensoface: Cal Timer	Calibration timer elapsed.	Check calibration timer setting if required. Calibrate/adjust sensor.
P069	⊗	Sad Sensoface: Calimatic		Verify calibration. Recalibrate/readjust sensor or replace sensor if required.
P070	par	Sad Sensoface: Wear	Sensor is worn (100%).	Replace sensor.
P071	par	Sad Sensoface: Leakage Current	ISFET sensor defective.	Replace sensor.
P072	par	Sad Sensoface: Op. Point	ISFET sensor: Operating point out of permissible range	Readjust ISFET zero point, replace sensor if required.
P073	par	TTM Maintenance Timer	ISM sensor: Maintenance timer elapsed.	Clean/maintain the sensor. Next, reset the counter in the Maintenance menu: Maintenance ▶ [II] ISM pH ▶ Sensor Maintenance
P074	par	Sad Sensoface: Zero	ORP zero offset is too large.	Readjust ORP, replace sensor if required.
P075	par	DLI Lifetime Indicator	Operating time of ISM sensor exceeded.	Replace sensor.
P090	⊗	Error in Buffer Table	The conditions for the buffer table were not adhered to:	Check and correct the configuration if required. → <i>pH Buffer Table: Entry of Individual Buffer Set (FW-E002), p. 186</i>
P093	Info	Buffer Distance Too Short	Manual calibration: pH values of calibration buffer are too close to each other.	Check parameter settings and correct if required.
P110	par	CIP Counter	Configured number of CIP cycles exceeded.	Calibrate/adjust sensor or replace sensor if required.
P111	par	SIP Counter	Configured number of SIP cycles exceeded.	Calibrate/adjust sensor or replace sensor if required.

No.	Type	Message Text	Possible Cause	Remedy
P112	par	Autoclaving Counter	Configured number of autoclavings exceeded.	Calibrate/adjust sensor or replace sensor if required.
P113	par	Sensor Operating Time	Sensor operating time exceeded.	Replace sensor.
P120	⊗	Wrong Sensor (Sensor Verif.)	If sensor check is active: An impermissible sensor is connected to the device.	Connect correct sensor or deactivate function.
P121	⊗	Sensor Error (Factory Settings)	Digital sensor delivers an error. Sensor no longer functions properly.	Replace sensor.
P122	↔	Sensor Memory (Cal Data)	Digital sensor delivers an error. The calibration data are faulty.	Calibrate/adjust sensor.
P123	↔	New Sensor – Adjustment Required	A new digital sensor was connected.	Adjust sensor.
P124	↔	Sensor Date	Sensor calibration date is not plausible.	Verify set date: Parameter Setting ▶ System Control ▶ Time/Date
P130	Info	SIP Cycle Counted	A SIP cycle was entered in the Maintenance menu.	
P131	Info	CIP Cycle Counted	A CIP cycle was entered in the Maintenance menu.	
P201	Info	Calibration: Temperature	The calibration temperature is impermissible.	Verify calibration. Note the information in the Calibration chapter. → <i>pH Process Variable Calibration/Adjustment, p. 113</i>
P202	Info	Calibration: Buffer Unknown	Calibration error during automatic Calimatic calibration: Buffer not recognized.	Verify calibration. Note the information in the Calibration chapter. → <i>Calibration Mode: Calimatic, p. 115</i>
			Incorrect buffer set selected.	Select the buffer set used in the parameter settings: Parameter Setting ▶ [I] [II] [Sensor] ▶ Cal Presettings
			Buffer corrupted.	Use the new buffer solution.
		Sensor defective.	Replace sensor.	
P203	Info	Calibration: Identical Buffers	Calibration error during automatic Calimatic calibration: The same buffer was used.	Use different buffer solutions.
			Sensor or sensor cable defective.	Check sensor and cables, replace if required.
P204	Info	Calibration: Buffers Interchanged	Calibration error during manual calibration: Buffer order differs from specifications.	Repeat the calibration and note the specified order. → <i>Calibration Mode: Manual, p. 117</i>
P205	Info	Calibration: Sensor Unstable	Drift criterion not adhered to during calibration.	
			Faulty calibration.	Repeat calibration/adjustment.
			Sensor cable/connection faulty.	Check sensor cable/connection, replace if required.
			Sensor worn.	Replace sensor.
P206	Info	Calibration: Slope	Slope outside of permissible limits	Repeat calibration/adjustment or replace sensor.
P207	Info	Calibration: Zero Point	Zero point outside of permissible limits	Repeat calibration/adjustment or replace sensor.

No.	Type	Message Text	Possible Cause	Remedy
P208	Info	Calibration: Sensor Failure	Sensor defective.	Replace sensor.

Calculation Block pH/pH

No.	Type	Message Text	Possible Cause	Remedy
A001		Configuration Data Loss	Data error in the parameter settings	Completely reconfigure the device.
A010		pH Diff Range	pH value difference: Value above/below device limits. Sensor or sensor cable incorrectly connected.	Check both pH values. Check sensor/cable connections, correct if required.
A011		pH Diff LO_LO	Value below configured monitoring limit.	
A012		pH Diff LO	Value below configured monitoring limit.	
A013		pH Diff HI	Value above configured monitoring limit.	
A014		pH Diff HI_HI	Value above configured monitoring limit.	
A015		Temperature Diff Range	Temperature value difference. Value above/below device limits. Sensor or sensor cable incorrectly connected.	Check both temperature values. Check sensor/cable connections, correct if required.
A016		Temperature Diff LO_LO	Value below configured monitoring limit.	
A017		Temperature Diff LO	Value below configured monitoring limit.	
A018		Temperature Diff HI	Value above configured monitoring limit.	
A019		Temperature Diff HI_HI	Value above configured monitoring limit.	
A020		ORP Diff Range	ORP value difference. Value above/below device limits. Sensor or sensor cable incorrectly connected.	Check both ORP values. Check sensor/cable connections, correct if required.
A021		ORP Diff LO_LO	Value below configured monitoring limit.	
A022		ORP Diff LO	Value below configured monitoring limit.	
A023		ORP Diff HI	Value above configured monitoring limit.	
A024		ORP Diff HI_HI	Value above configured monitoring limit.	
A045		pH Voltage Diff Range	Different pH voltage: Value above/below device limits. Sensor or sensor cable incorrectly connected.	Check both pH voltage values. Check sensor/cable connections, correct if required.
A046		pH Voltage Diff LO_LO	Value below configured monitoring limit.	
A047		pH Voltage Diff LO	Value below configured monitoring limit.	

No.	Type	Message Text	Possible Cause	Remedy
A048		pH Voltage Diff HI	Value above configured monitoring limit.	
A049		pH Voltage Diff HI_HI	Value above configured monitoring limit.	
A200		Param. Calculation Block	Faulty configuration of calculation blocks.	Check parameter settings: Parameter Setting ▶ System Control ▶ Calculation Blocks

Conductivity (Contacting)

No.	Type	Message Text	Possible Cause	Remedy
C001		Configuration Data Loss	Data error in the parameter settings	Completely reconfigure the device.
C008		Adjustment Data	Error in the adjustment data	Disable device (approx. 10 s). If the message persists, send in the device.
C009		Firmware Error	Error in the firmware	Disable device (approx. 10 s). Re-load the firmware. → <i>Firmware Update (FW-E106), p. 204</i> If the message persists, send in the device.
C010		Conductivity Range	Value above/below measuring range.	Check measuring range, adjust if required.
			Sensor connected incorrectly or not at all.	Check sensor connection. Connect sensor if required.
			Sensor cable connected incorrectly or defective.	Check sensor cable, replace if required.
			With module MK-COND025: Incorrect cell constant set.	Check parameter settings, correct if required. Parameter Setting ▶ [II] Analog Cond ▶ Sensor Data
C011		Conductivity LO_LO	Value below configured monitoring limit.	
C012		Conductivity LO	Value below configured monitoring limit.	
C013		Conductivity HI	Value above configured monitoring limit.	
C014		Conductivity HI_HI	Value above configured monitoring limit.	
C015		Temperature Range	Value above/below measuring range.	Check measuring range, adjust if required.
			Sensor connected incorrectly or not at all.	Check sensor connection. Connect sensor if required.
			Sensor, sensor cable or temperature detector defective.	Check sensor, cable, and temperature detector, replace if required.
			With module MK-COND025: Incorrect temperature detector selected.	Select temperature detector used: Parameter Setting ▶ [II] Analog Cond ▶ Sensor Data ▶ Temperature Detection
C016		Temperature LO_LO	Value below configured monitoring limit.	
C017		Temperature LO	Value below configured monitoring limit.	
C018		Temperature HI	Value above configured monitoring limit.	

No.	Type	Message Text	Possible Cause	Remedy
C019	⊗	Temperature HI_HI	Value above configured monitoring limit.	
C020	⊗	Resistivity Range	Value above/below measuring range. Sensor connected incorrectly or not at all. Sensor cable connected incorrectly or defective. With module MK-COND025: Incorrect cell constant set.	Check measuring range, adjust if required. Check sensor connection. Connect sensor if required. Check sensor cable, replace if required. Check parameter settings, correct if required. Parameter Setting ▶ [II] Analog Cond ▶ Sensor Data
C021	⊗	Resistivity LO_LO	Value below configured monitoring limit.	
C022	⚠	Resistivity LO	Value below configured monitoring limit.	
C023	⚠	Resistivity HI	Value above configured monitoring limit.	
C024	⊗	Resistivity HI_HI	Failure: Value above configured monitoring limit.	
C025	⊗	Concentration Range	Value above/below measuring range. Sensor connected incorrectly or not at all. Sensor cable connected incorrectly or defective. With module MK-COND025: Incorrect cell constant set.	Check measuring range, adjust if required. Check sensor connection. Connect sensor if required. Check sensor cable, replace if required. Check parameter settings, correct if required. Parameter Setting ▶ [II] Analog Cond ▶ Sensor Data
C026	⊗	Concentration LO_LO	Value below configured monitoring limit.	
C027	⚠	Concentration LO	Value below configured monitoring limit.	
C028	⚠	Concentration HI	Value above configured monitoring limit.	
C029	⊗	Concentration HI_HI	Value above configured monitoring limit.	
C040	⊗	Salinity Range	Value above/below measuring range. Sensor connected incorrectly or not at all. Sensor cable connected incorrectly or defective. With module MK-COND025: Incorrect cell constant set.	Check measuring range, adjust if required. Check sensor connection. Connect sensor if required. Check sensor cable, replace if required. Check parameter settings, correct if required. Parameter Setting ▶ [II] Analog Cond ▶ Sensor Data
C041	⊗	Salinity LO_LO	Value below configured monitoring limit.	
C042	⚠	Salinity LO	Value below configured monitoring limit.	
C043	⚠	Salinity HI	Value above configured monitoring limit.	

No.	Type	Message Text	Possible Cause	Remedy
C044	⊗	Salinity HI_HI	Value above configured monitoring limit.	
C045	⊗	Conductance Range	Value above measuring range. Sensor connected incorrectly or not at all. Wrong sensor for the measuring range Sensor cable defective (short circuit).	Check measuring range, adjust if required. Check sensor connection. Connect sensor if required. Connect the right sensor. Replace cable.
C060	par	Sad Sensoface: Polarization	The sensor is polarized. Sensor is not suitable for the measuring range or process medium.	Connect a suitable sensor.
C062	par	Sad Sensoface: Cell Constant	Faulty calibration. With module MK-COND025: Incorrect cell constant set.	Repeat calibration/adjustment, replace sensor if required. Check parameter settings, correct if required. Parameter Setting ▶ [II] Analog Cond ▶ Sensor Data
C070	⊗	TDS Range	Value above/below measuring range. Sensor connected incorrectly or not at all. Sensor cable connected incorrectly or defective. With module MK-COND025: Incorrect cell constant set.	Check measuring range, adjust if required. Check sensor connection. Connect sensor if required. Check sensor cable, replace if required. Check parameter settings, correct if required. Parameter Setting ▶ [II] Analog Cond ▶ Sensor Data
C071	⊗	TDS LO_LO	Value below configured monitoring limit.	
C072	⚠	TDS LO	Value below configured monitoring limit.	
C073	⚠	TDS HI	Value above configured monitoring limit.	
C074	⊗	TDS HI_HI	Value above configured monitoring limit.	
C090	par	USP Limit	The configured USP limit value was exceeded.	
C091	par	Reduced USP Limit	The configured reduced USP limit value was exceeded.	
C110	par	CIP Counter	Configured number of CIP cycles exceeded.	Calibrate/adjust sensor or replace sensor if required.
C111	par	SIP Counter	Configured number of SIP cycles exceeded.	Calibrate/adjust sensor or replace sensor if required.
C113	par	Sensor Operating Time	Sensor operating time exceeded.	Replace sensor.
C122	Info	Sensor Memory (Cal Data)	Digital sensor delivers an error. The calibration data are faulty.	Calibrate/adjust sensor.
C123	Info	New Sensor – Adjustment Required	A new digital sensor was connected.	Adjust sensor.

No.	Type	Message Text	Possible Cause	Remedy
C124	Info	Sensor Date	Sensor calibration date is not plausible.	Verify set date: Parameter Setting ▶ System Control ▶ Time/Date
C204	Info	Calibration: Sensor Unstable	Drift criterion not adhered to during calibration. Faulty calibration. Sensor cable/connection faulty. Sensor worn.	Repeat calibration/adjustment. Check sensor cable/connection, replace if required. Replace sensor.

Calculation Block Cond/Cond









No.	Type	Message Text	Possible Cause	Remedy
E001	⊗	Configuration Data Loss	Data error in the parameter settings	Completely reconfigure the device.
E010	⊗	Conductivity Diff Range	Conductivity value difference: Value above/below device limits. Sensor or sensor cable incorrectly connected.	Check both conductivity values. Check sensor/cable connections, correct if required.
E011	⊗	Conductivity Diff LO_LO	Value below configured monitoring limit.	
E012	⚠	Conductivity Diff LO	Value below configured monitoring limit.	
E013	⚠	Conductivity Diff HI	Value above configured monitoring limit.	
E014	⊗	Conductivity Diff HI_HI	Value above configured monitoring limit.	
E015	⊗	Temperature Diff Range	Temperature value difference. Value above/below device limits. Sensor or sensor cable incorrectly connected.	Check both temperature values. Check sensor/cable connections, correct if required.
E016	⊗	Temperature Diff LO_LO	Value below configured monitoring limit.	
E017	⚠	Temperature Diff LO	Value below configured monitoring limit.	
E018	⚠	Temperature Diff HI	Value above configured monitoring limit.	
E019	⊗	Temperature Diff HI_HI	Value above configured monitoring limit.	
E020	⊗	Resistivity Diff Range	Resistivity difference. Value above/below device limits. Sensor or sensor cable incorrectly connected.	Check both resistance values. Check sensor/cable connections, correct if required.
E021	⊗	Resistivity Diff LO_LO	Value below configured monitoring limit.	
E022	⚠	Resistivity Diff LO	Value below configured monitoring limit.	
E023	⚠	Resistivity Diff HI	Value above configured monitoring limit.	

No.	Type	Message Text	Possible Cause	Remedy
E024	⊗	Resistivity Diff HI_HI	Failure: Value above configured monitoring limit.	
E030	⊗	RATIO Range	Ratio: Value above/below device limits.	Check both conductivity values.
E031	⊗	RATIO LO_LO	Value below configured monitoring limit.	
E032	⚠	RATIO LO	Value below configured monitoring limit.	
E033	⚠	RATIO HI	Value above configured monitoring limit.	
E034	⊗	RATIO HI_HI	Value above configured monitoring limit.	
E035	⊗	PASSAGE Range	Passage: Value above/below device limits.	Check both conductivity values.
E036	⊗	PASSAGE LO_LO	Value below configured monitoring limit.	
E037	⚠	PASSAGE LO	Value below configured monitoring limit.	
E038	⚠	PASSAGE HI	Value above configured monitoring limit.	
E039	⊗	PASSAGE HI_HI	Value above configured monitoring limit.	
E045	⊗	REJECTION Range	Rejection: Value above/below device limits.	Check both conductivity values.
E046	⊗	REJECTION LO_LO	Value below configured monitoring limit.	
E047	⚠	REJECTION LO	Value below configured monitoring limit.	
E048	⚠	REJECTION HI	Value above configured monitoring limit.	
E049	⊗	REJECTION HI_HI	Value above configured monitoring limit.	
E050	⊗	DEVIATION Range	Deviation: Value above/below device limits.	Check both conductivity values.
E051	⊗	DEVIATION LO_LO	Value below configured monitoring limit.	
E052	⚠	DEVIATION LO	Value below configured monitoring limit.	
E053	⚠	DEVIATION HI	Value above configured monitoring limit.	
E054	⊗	DEVIATION HI_HI	Value above configured monitoring limit.	
E055	⊗	Remaining Capacity Range	Rem. capacity ion exchanger cannot be calculated.	
E056	⊗	Degassed Conductivity	Value above/below device limits.	Check both conductivity values.

No.	Type	Message Text	Possible Cause	Remedy
E057		Rem. Capacity Ion	Value above/below device limits.	
		Exchanger	<p>Remaining capacity of the ion exchanger < 20%</p> <p>Remaining capacity of the ion exchanger < 0%</p>	<p>Check ion exchanger, replace filter or ion exchanger if required.</p> <p>Replace ion exchanger. After replacing ion exchanger, confirm in Maintenance menu:</p> <p>Maintenance ▶ [CI] [CII] Calculation Cond-Cond</p>
E060		pH Range	<p>For selection</p> <p>Parameter Setting ▶</p> <p>[CI/II] Calculation Cond/Cond</p> <p>▶ pH Value : "Usage": "pH-VGB-S-006": pH measuring range outside permissible range of VGB technical guideline.</p>	Check both conductivity values.
			Alkalizing agent used does not match parameter setting.	Check the choice of alkalizing agent.
				Check the ion exchanger.
			Sensors or sensor cable connected incorrectly or defective.	Check both sensors/cables and replace if required.
E061		pH LO_LO	Value below configured monitoring limit.	
E062		pH LO	Value below configured monitoring limit.	
E063		pH HI	Value above configured monitoring limit.	
E064		pH HI_HI	Value above configured monitoring limit.	
E200		Param. Calculation Block	Faulty configuration of calculation blocks.	<p>Check parameter settings:</p> <p>Parameter Setting ▶ System Control ▶</p> <p>Calculation Blocks</p>

Conductivity (Inductive)

No.	Type	Message Text	Possible Cause	Remedy
T001	⊗	Configuration Data Loss	Data error in the parameter settings	Completely reconfigure the device.
T008	⊗	Adjustment Data	Error in the adjustment data	Disable device (approx. 10 s). If the message persists, send in the device.
T009	⊗	Firmware Error	Error in the firmware	Disable device (approx. 10 s). Re-load the firmware. → <i>Firmware Update (FW-E106)</i> , p. 204 If the message persists, send in the device.
T010	⊗	Conductivity Range	Value above/below measuring range.	Check measuring range, adjust if required.
			Sensor connected incorrectly or not at all.	Check sensor connection. Connect sensor if required.
			Sensor cable connected incorrectly or defective.	Check sensor cable, replace if required.
			With module MK-CONDI035: Incorrect cell factor set.	Check parameter settings, correct if required. Parameter Setting ▶ [!] Analog Condl ▶ Sensor Data
T011	⊗	Conductivity LO_LO	Value below configured monitoring limit.	
T012	⚠	Conductivity LO	Value below configured monitoring limit.	
T013	⚠	Conductivity HI	Value above configured monitoring limit.	
T014	⊗	Conductivity HI_HI	Value above configured monitoring limit.	
T015	⊗	Temperature Range	Value above/below measuring range.	Check measuring range, adjust if required.
			Sensor connected incorrectly or not at all.	Check sensor connection. Connect sensor if required.
			Sensor, sensor cable or temperature detector defective.	Check sensor, cable, and temperature detector, replace if required.
			With module MK-CONDI035: Incorrect temperature detector selected.	Select temperature detector used: Parameter Setting ▶ [!] Analog Condl ▶ Sensor Data ▶ Temperature Detection
T016	⊗	Temperature LO_LO	Value below configured monitoring limit.	
T017	⚠	Temperature LO	Value below configured monitoring limit.	
T018	⚠	Temperature HI	Value above configured monitoring limit.	
T019	⊗	Temperature HI_HI	Value above configured monitoring limit.	
T020	⊗	Resistivity Meas. Range	Value above/below measuring range.	Check measuring range, adjust if required.
			Sensor connected incorrectly or not at all.	Check sensor connection. Connect sensor if required.
			Sensor cable connected incorrectly or defective.	Check sensor cable, replace if required.
			With module MK-CONDI035: Incorrect cell factor set.	Check parameter settings, correct if required. Parameter Setting ▶ [!] Analog Condl ▶ Sensor Data

No.	Type	Message Text	Possible Cause	Remedy
T021		Resistivity LO_LO	Value below configured monitoring limit.	
T022		Resistivity LO	Value below configured monitoring limit.	
T023		Resistivity HI	Value above configured monitoring limit.	
T024		Resistivity HI_HI	Value above configured monitoring limit.	
T025		Concentration Range	Value above/below measuring range.	Check measuring range, adjust if required.
			Sensor connected incorrectly or not at all.	Check sensor connection. Connect sensor if required.
			Sensor cable connected incorrectly or defective.	Check sensor cable, replace if required.
			With module MK-CONDI035: Incorrect cell factor set.	Check parameter settings, correct if required. Parameter Setting ▶ [II] Analog Cond1 ▶ Sensor Data
T026		Concentration LO_LO	Value below configured monitoring limit.	
T027		Concentration LO	Value below configured monitoring limit.	
T028		Concentration HI	Value above configured monitoring limit.	
T029		Concentration HI_HI	Value above configured monitoring limit.	
T040		Salinity Range	Value above/below measuring range.	Check measuring range, adjust if required.
			Sensor connected incorrectly or not at all.	Check sensor connection. Connect sensor if required.
			Sensor cable connected incorrectly or defective.	Check sensor cable, replace if required.
			With module MK-CONDI035: Incorrect cell factor set.	Check parameter settings, correct if required. Parameter Setting ▶ [II] Analog Cond1 ▶ Sensor Data
T041		Salinity LO_LO	Value below configured monitoring limit.	
T042		Salinity LO	Value below configured monitoring limit.	
T043		Salinity HI	Value above configured monitoring limit.	
T044		Salinity HI_HI	Value above configured monitoring limit.	
T045		Conductance Range	Value above measuring range.	Check measuring range, adjust if required.
			Sensor connected incorrectly or not at all.	Check sensor connection. Connect sensor if required.
			Wrong sensor for the measuring range	Connect the right sensor.
			Sensor cable defective (short circuit).	Replace cable.
T060	par	Sad Sensoface: Primary Coil	Sensor defective.	Replace sensor.

No.	Type	Message Text	Possible Cause	Remedy
T061	par	Sad Sensoface: Secondary Coil	Sensor defective.	Replace sensor.
T063	par	Sad Sensoface: Zero Point		Adjust sensor zero point.
T064	par	Sad Sensoface: Cell Factor	Faulty calibration. With module MK-CONDI035: Incorrect cell factor set.	Repeat calibration/adjustment. Replace sensor if required. Check parameter settings, correct if required. Parameter Setting ▶ [II] Analog Condl ▶ Sensor Data
T070	⊗	TDS Range	Value above/below measuring range. Sensor connected incorrectly or not at all. Sensor cable connected incorrectly or defective. With module MK-CONDI035: Incorrect cell factor set.	Check measuring range, adjust if required. Check sensor connection. Connect sensor if required. Check sensor cable, replace if required. Check parameter settings, correct if required. Parameter Setting ▶ [II] Analog Condl ▶ Sensor Data
T071	⊗	TDS LO_LO	Value below configured monitoring limit.	
T072	⚠	TDS LO	Value below configured monitoring limit.	
T073	⚠	TDS HI	Value above configured monitoring limit.	
T074	⊗	TDS HI_HI	Value above configured monitoring limit.	
T090	par	USP Limit	Configured USP limit value exceeded.	
T091	par	Reduced USP Limit	The configured reduced USP limit value was exceeded.	
T111	par	SIP Counter	Configured number of SIP cycles exceeded.	Calibrate/adjust sensor or replace sensor if required.
T113	par	Sensor Operating Time	Sensor operating time exceeded.	Replace sensor.
T122	Info	Sensor Memory (Cal Data)	Digital sensor delivers an error. The calibration data are faulty.	Calibrate/adjust sensor.
T123	Info	New Sensor – Adjustment Required	A new digital sensor was connected.	Adjust sensor.
T124	Info	Sensor Date	Sensor calibration date is not plausible.	Verify set date: Parameter Setting ▶ System Control ▶ Time/Date
T205	Info	Calibration: Sensor Unstable	Drift criterion not adhered to during calibration. Faulty calibration. Sensor cable/connection faulty. Sensor worn.	Repeat calibration/adjustment. Check sensor cable/connection, replace if required. Replace sensor.

Oxygen















No.	Type	Message Text	Possible Cause	Remedy
D001	⊗	Configuration Data Loss	Data error in the parameter settings	Completely reconfigure the device.
D008	⊗	Adjustment Data	Error in the adjustment data	Disable device (approx. 10 s). If the message persists, send in the device.
D009	⊗	Firmware Error	Error in the firmware	Disable device (approx. 10 s). Re-load the firmware. → <i>Firmware Update (FW-E106)</i> , p. 204 If the message persists, send in the device.
D010	⊗	Sat. %Air Range	Value above/below measuring range.	Check measuring range, adjust if required.
			Sensor connected incorrectly or not at all.	Check sensor connection. Connect sensor if required.
			Sensor cable connected incorrectly or defective.	Check sensor cable, replace if required.
D011	⊗	Sat. %Air LO_LO	Value below configured monitoring limit.	
D012	⚠	Saturation %Air LO	Value below configured monitoring limit.	
D013	⚠	Saturation %Air HI	Value above configured monitoring limit.	
D014	⊗	Sat. %Air HI_HI	Value above configured monitoring limit.	
D015	⊗	Temperature Range	Value above/below measuring range.	Check measuring range, adjust if required.
			Sensor connected incorrectly or not at all.	Check sensor connection. Connect sensor if required.
			Sensor, sensor cable or temperature detector defective.	Check sensor, cable, and temperature detector, replace if required.
			With module MK-OXY046: Incorrect temperature detector selected.	Select temperature detector used: Parameter Setting ▶ [II] Analog Oxy ▶ Sensor Data ▶ Temperature Probe
D016	⊗	Temperature LO_LO	Value below configured monitoring limit.	
D017	⚠	Temperature LO	Value below configured monitoring limit.	
D018	⚠	Temperature HI	Value above configured monitoring limit.	
D019	⊗	Temperature HI_HI	Value above configured monitoring limit.	
D020	⊗	Concentration Range	Value above/below measuring range.	Check measuring range, adjust if required.
			Sensor connected incorrectly or not at all.	Check sensor connection. Connect sensor if required.
			Sensor cable connected incorrectly or defective.	Check sensor cable, replace if required.
D021	⊗	Concentration LO_LO	Value below configured monitoring limit.	
D022	⚠	Concentration LO	Value below configured monitoring limit.	







No.	Type	Message Text	Possible Cause	Remedy
D023	⚠	Concentration HI	Value above configured monitoring limit.	
D024	⊗	Concentration HI_HI	Value above configured monitoring limit.	
D025	⊗	Partial Pressure Range	Value above/below measuring range.	Check measuring range, adjust if required.
			Sensor connected incorrectly or not at all.	Check sensor connection. Connect sensor if required.
			Sensor cable connected incorrectly or defective.	Check sensor cable, replace if required.
D026	⊗	Part. Pressure LO_LO	Value below configured monitoring limit.	
D027	⚠	Part. Pressure LO	Value below configured monitoring limit.	
D028	⚠	Partial Pressure HI	Value above configured monitoring limit.	
D029	⊗	Part. Pressure HI_HI	Value above configured monitoring limit.	
D040	⊗	Process Pressure Range	Value above/below measuring range.	Check measuring range, adjust if required.
			Sensor connected incorrectly or not at all.	Check sensor connection. Connect sensor if required.
			Sensor cable connected incorrectly or defective.	Check sensor cable, replace if required.
D041	⊗	Process Pressure LO_LO	Value below configured monitoring limit.	
D042	⚠	Process Pressure LO	Value below configured monitoring limit.	
D043	⚠	Process Pressure HI	Value above configured monitoring limit.	
D044	⊗	Process Pressure HI_HI	Value above configured monitoring limit.	
D045	⊗	Saturation %O2 Range	Value above/below measuring range.	Check measuring range, adjust if required.
			Sensor connected incorrectly or not at all.	Check sensor connection. Connect sensor if required.
			Sensor cable connected incorrectly or defective.	Check sensor cable, replace if required.
D046	⊗	Saturation %O2 LO_LO	Value below configured monitoring limit.	
D047	⚠	Saturation %O2 LO	Value below configured monitoring limit.	
D048	⚠	Saturation %O2 HI	Value above configured monitoring limit.	
D049	⊗	Saturation %O2 HI_HI	Value above configured monitoring limit.	
D060	par	Sad Sensoface: Slope	Faulty adjustment or worn/faulty sensor.	Calibrate/adjust sensor. Replace sensor if required.
			Not enough electrolyte in sensor.	Check/refill electrolyte.

No.	Type	Message Text	Possible Cause	Remedy
D061	par	Sad Sensoface: Zero Point	Sensor calibration/adjustment overdue. Faulty calibration. Not enough electrolyte in sensor Sensor defective.	Calibrate/adjust sensor. Repeat calibration/adjustment. Check/refill electrolyte. Replace sensor.
D062	par	Sad Sensoface: Sensocheck		Readjust configured sensor. Replace sensor.
D063	par	Sad Sensoface: Settling Time		Readjust configured sensor. Replace sensor.
D064	⊗	Sad Sensoface: Cal Timer	Calibration timer has expired.	Check calibration timer setting if required. Calibrate/adjust sensor.
D065	par	Sad Sensoface: Leakage Current	Sensor defective.	Replace sensor.
D070	par	Sad Sensoface: Wear	Sensor is worn (100%).	Calibrate/adjust sensor. Check electrolyte, refill if required. Replace sensor.
D071	par	Sad Sensoface: Membrane	Only for optical oxygen sensor: Membrane damaged/worn.	Replace membrane body.
D073	par	Sad Sensoface: DLI	ISM sensor worn.	Replace sensor.
D080	par	Sensor Current Range	Incorrect polarization voltage set. Not enough electrolyte in sensor Sensor calibration/adjustment overdue.	Check parameter settings, correct if required: Parameter Setting ▶ [I] [II] ... Oxy ▶ Sensor Data Refill electrolyte. Calibrate/adjust sensor.
D081	par	O2 Measurement OFF (Temp)	Only for optical oxygen sensor: Oxygen measurement automatically stopped because the temperatures are too high. → <i>Oxygen Measurement with CIP, p. 99</i>	
D110	par	CIP Counter	Configured number of CIP cycles exceeded.	Calibrate/adjust sensor or replace sensor if required.
D111	par	SIP Counter	Configured number of SIP cycles exceeded.	Calibrate/adjust sensor or replace sensor if required.
D112	par	Autoclaving Counter	Configured number of autoclavings exceeded.	Calibrate/adjust sensor or replace sensor if required.
D113	par	Sensor Operating Time	Sensor operating time exceeded.	Replace sensor.
D114	par	Membrane Body Replacement	Configured number of membrane body replacements exceeded.	Replace membrane body. Confirm replacement in Maintenance menu. → <i>Channel I/II Maintenance Functions, p. 150</i> Calibrate/adjust sensor.
D115	par	Interior Body Replacement	Configured number of interior body replacements exceeded.	Replace the interior body. Confirm replacement in Maintenance menu. → <i>Channel I/II Maintenance Functions, p. 150</i> Calibrate/adjust sensor.

No.	Type	Message Text	Possible Cause	Remedy
D121	⊗	Sensor Error (Factory Settings)	Digital sensor delivers an error. Sensor no longer functions properly.	Replace sensor.
D122	⊕	Sensor Memory (Cal Data)	Digital sensor delivers an error. The calibration data are faulty.	Calibrate/adjust sensor.
D123	⊕	New Sensor – Adjustment Required	A new digital sensor was connected.	Adjust sensor.
D124	Info	Sensor Date	Sensor calibration date is not plausible.	Verify set date: Parameter Setting ▶ System Control ▶ Time/Date
D201	Info	Calibration: Temperature	Calibration temperature is impermissible	Check the calibration temperature. Note the information in the Calibration chapter.
D205	Info	Calibration: Sensor Unstable	Drift criterion not adhered to during calibration.	Replace sensor.
			Faulty calibration.	Repeat calibration/adjustment.
			Sensor cable/connection faulty.	Check sensor cable/connection, replace if required.
			Sensor worn.	Replace sensor.

Calculation Block Oxy/Oxy

No.	Type	Message Text	Possible Cause	Remedy
H001		Configuration Data Loss	Data error in the parameter settings	Completely reconfigure the device.
H010		Saturation %Air Diff Range	Saturation value difference: Value above/below device limits.	Check both saturation values.
			Sensor or sensor cable incorrectly connected.	Check sensor/cable connections, correct if required.
H011		Saturation %Air Diff LO_LO	Value below configured monitoring limit.	
H012		Sat. %Air Diff LO	Value below configured monitoring limit.	
H013		Sat. %Air Diff HI	Value above configured monitoring limit.	
H014		Saturation %Air Diff HI_HI	Value above configured monitoring limit.	
H015		Temperature Diff Range	Temperature value difference. Value above/below device limits.	Check both conductivity values.
			Sensor or sensor cable incorrectly connected.	Check sensor/cable connections, correct if required.
H016		Temperature Diff LO_LO	Value below configured monitoring limit.	
H017		Temperature Diff LO	Value below configured monitoring limit.	
H018		Temperature Diff HI	Value above configured monitoring limit.	
H019		Temperature Diff HI_HI	Value above configured monitoring limit.	
H020		Conc. (Liquid) Diff Range	Concentration value difference: Value above/below device limits.	Check both concentration values.
			Sensor or sensor cable incorrectly connected.	Check sensor/cable connections, correct if required.
H021		Conc. (Liquid) Diff LO_LO	Value below configured monitoring limit.	
H022		Conc. (Liquid) Diff LO	Value below configured monitoring limit.	
H023		Conc. (Liquid) Diff HI	Value above configured monitoring limit.	
H024		Conc. (Liquid) Diff HI_HI	Failure: Value above configured monitoring limit.	
H045		Saturation %O2 Diff Range	Saturation value difference. Value above/below device limits.	Check both saturation values.
			Sensor or sensor cable incorrectly connected.	Check sensor/cable connections, correct if required.
H046		Saturation %O2 Diff LO_LO	Value below configured monitoring limit.	
H047		Saturation %O2 Diff LO	Value below configured monitoring limit.	
H048		Saturation %O2 Diff HI	Value above configured monitoring limit.	
H049		Saturation %O2 Diff HI_HI	Value above configured monitoring limit.	

No.	Type	Message Text	Possible Cause	Remedy
H090		Conc. (Gas) Diff Range	Concentration value difference: Value above/below device limits.	Check both concentration values.
			Sensor or sensor cable incorrectly connected.	Check sensor/cable connections, correct if required.
H091		Conc. (Liquid) Diff LO_LO	Value below configured monitoring limit.	
H092		Conc. (Gas) Diff LO	Value below configured monitoring limit.	
H093		Conc. (Gas) Diff HI	Value above configured monitoring limit.	
H094		Conc. (Gas) Diff HI_HI	Value above configured monitoring limit.	
H200		Param. Calculation Block	Faulty parameter setting	Check parameter settings and cor- rect if required: Parameter Setting ▶ System Control ▶ Calculation Blocks

12.3 Sensocheck and Sensoface

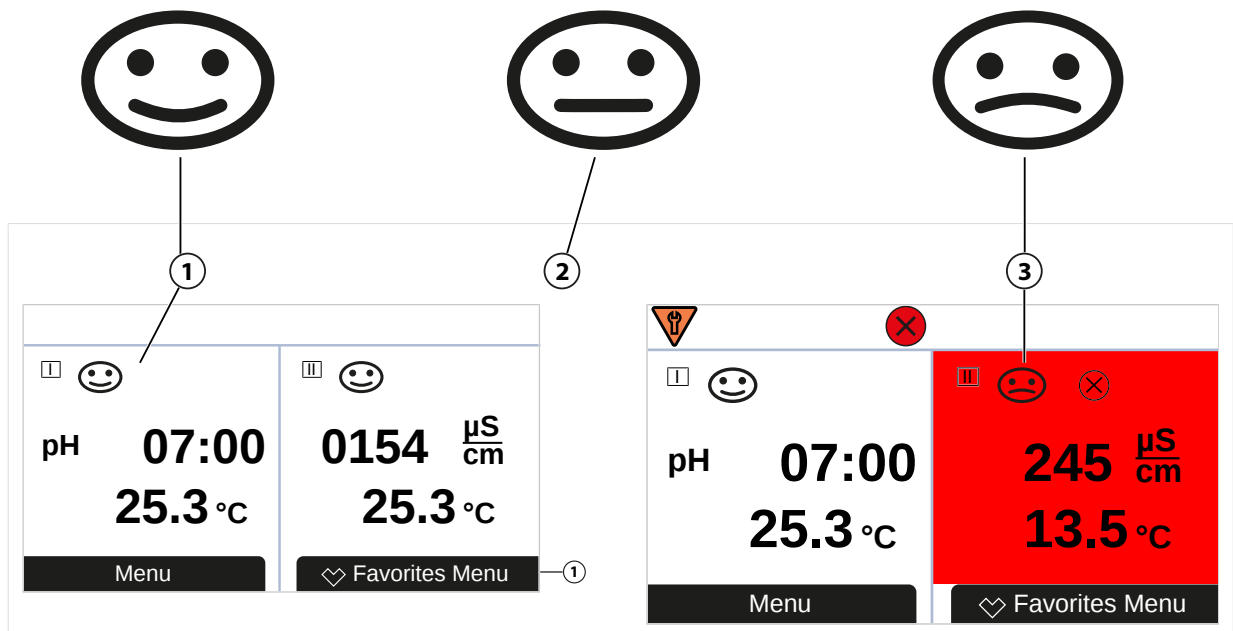

1 Happy Sensoface 2 Neutral Sensoface 3 Sad Sensoface

The Sensoface icons provide users with diagnostic information on the wear and required maintenance of the sensor. In measuring mode, an icon (happy, neutral, or sad smiley) is shown on the display to reflect the continuous monitoring of the sensor parameters.

You can set the current output parameters such that a Sensoface message generates a 22 mA error signal.

Parameter Setting ▶ Inputs/Outputs ▶ Current Outputs ▶ Current Output I... ▶ Behavior during Messages

Sensoface messages can also be output via a relay contact:

Parameter Setting ▶ Inputs/Outputs ▶ Relay Contacts ▶ Contact K... ▶ Usage → Usage: Sensoface, p. 62

If **Sensoface** is selected, the Sensoface messages of all channels are output via the selected contact.

If **Sensoface (Channel)** is selected, you can output the Sensoface messages of a specific channel via the selected contact.

Enabling/Disabling Sensoface

Sensoface is enabled and disabled in the **Sensor Data** submenu:

Parameter Setting ▶ [I] [II] [Sensor] ▶ Sensor Data



Note: After a calibration, a smiley is always displayed for confirmation, even if Sensoface is disabled.

USE CAUTION WHEN CONDUCTING ANY TROUBLESHOOTING. FAILURE TO ABIDE BY THE REQUIREMENTS SET FORTH HEREIN MAY RESULT IN SERIOUS INJURY OR DEATH, AS WELL AS DAMAGE TO PROPERTY.



Further support for troubleshooting is available at → support@knick.de.

Sensoface Criteria



pH

Sensoface	Slope	Zero Point ¹⁾
 Happy	53.3 ... 61 mV/pH	pH 6 ... 8
 Sad	< 53.3 mV/pH or > 61 mV/pH	< pH 6 or > pH 8





Conductivity (Contacting)

Sensoface	Cell Constant	
	Analog Sensors	Memosens
 Happy	0.005 cm ⁻¹ ... 19.9999 cm ⁻¹	0.5x nom. cell constant ... 2x nom. cell constant
 Sad	< 0.005 cm ⁻¹ or > 19.9999 cm ⁻¹	< 0.5x nom. cell constant or > 2x nom. cell constant

Conductivity (Inductive)

Sensoface	Cell Factor		Zero Point
	Analog Sensors	Memosens	
 Happy	0.1 cm ⁻¹ ... 19.9999 cm ⁻¹	0.5x nom. cell factor ... 2x nom. cell factor	-0.25 mS ... 0.25 mS
 Sad	< 0.1 cm ⁻¹ or > 19.9999 cm ⁻¹	< 0.5x nom. cell factor or 2x nom. cell factor	< -0.25 mS or > 0.25 mS

Oxygen

Sensoface	Slope		
	Standard Sensor (SE7*6)	Trace Sensor 01 (SE7*7 ...)	Trace Sensor 001
 Happy	-110 nA ... -30 nA	-525 nA ... -225 nA	-8000 nA ... -2500 nA
 Sad	< -110 nA or > -30 nA	< -525 nA or > -225 nA	< -8000 nA or > -2500 nA
Sensoface	Zero Point		
	Standard Sensor (SE7*6)	Trace Sensor 01 (SE7*7 ...)	Trace Sensor 001
 Happy	-1 nA ... 1 nA	-1 nA ... 1 nA	-3 nA ... 3 nA
 Sad	< -1 nA or > 1 nA	< -1 nA or > 1 nA	< -3 nA or > 3 nA

Note: The worsening of a Sensoface criterion leads to the devaluation of the Sensoface display (Smiley gets "sad"). An improvement of the Sensoface display can only take place after calibration or removal of the sensor defect.

¹⁾ Applies to standard sensors with zero point pH 7

Sensocheck

Process Variable	Sensocheck Function
pH:	Automated monitoring of glass and reference electrodes
Oxygen:	Monitoring of membrane/electrolyte
Conductivity:	Notes on sensor state

Enable/Disable Sensocheck

Sensocheck is enabled and disabled in the **Sensor Data** submenu:

With Memosens:

Parameter Setting ▶ **[I] [II] Memosens ...** ▶ **Sensor Data** ▶ **Sensor Monitoring Details** ▶ **Sensocheck**

You can enable or disable Sensocheck in the **Monitoring** menu item.

In the **Message** menu item, select whether a Sensocheck message is output as a Failure or Maintenance Required message.

With analog sensors:

Parameter Setting ▶ **[I] [II] [Sensor]** ▶ **Sensor Data** ▶ **Sensocheck**

In the **Sensocheck** menu item, you can disable Sensocheck or choose to output a Sensocheck message as a Failure or Maintenance Required message.

13 Accessories

Mounting Accessories → *Dimension Drawings, p. 19*

Accessories	Order No.
Pipe-mount kit	ZU0274
Panel-mount kit	ZU0738
Protective hood	ZU0737
M12 socket for sensor connection with Memosens cable/M12 connector	ZU0860
RJ45 socket	ZU1072
Adapter cable RJ45/M12 D-type	ZU1073
Memory Cards, Non-Ex	Order No.
Data Card	ZU1080-S-N-D
FW Update Card	ZU1080-S-N-U
FW Repair Card	ZU1080-S-N-R
Custom FW Update Card	ZU1080-S-N-S-*** ¹⁾
Custom FW Repair Card	ZU1080-S-N-V-*** ¹⁾

13.1 Memory Card

Intended Use

Memory cards are used to save data or make firmware changes in conjunction with the Stratos Multi E471N. The device's measurement data, configuration data, and firmware can be saved.

The corresponding settings are made in **System Control** :

Menu Selection ▶ **Parameter Setting** ▶ **System Control** ▶ **Memory Card**

Inserting/Removing the Memory Card

⚠ WARNING! Voltages dangerous to touch. When opening the device, there may be dangerous touch voltages in the terminal compartment. Professional installation guarantees direct touch protection.

The memory card can be replaced during operation. When doing so, maintain sufficient distance from the power cord and do not use tools.

01. Deactivate any Data Card currently in use, see below.
02. Loosen the 4 screws on the front.
03. Open the front unit.
04. Take the memory card out of its packaging.
05. Insert the memory card with the connections at the front into the memory card slot on the front unit.

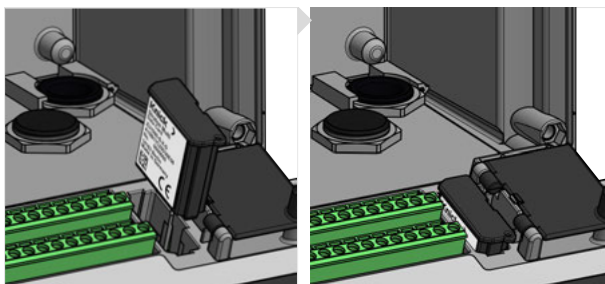

¹⁾ *** = device firmware

06. Close the enclosure and successively tighten the enclosure screws in a diagonal pattern.
Tightening torque 0.5 ... 2 Nm
✓ The display shows an icon indicating the memory card type.

Deactivating the Data Card

Note: When using a Data Card: Before disconnecting the supply voltage and before removing, the memory card must be deactivated to prevent data being exposed to potential loss.

01. Open the Maintenance menu.
02. Open/Close Memory Card :
03. With **right softkey: Close**, exit access to the memory card.
✓ The Data Card icon on the display is marked with an [x].



04. Remove the memory card, see above.

Reactivating the Data Card

If the Data Card is not removed after being deactivated, the Data Card icon on the display continues to be marked with an [x]. The Data Card must be reactivated for further use:

01. Open the Maintenance menu.
02. Open/Close Memory Card :
03. Press right softkey: Open to reactivate the memory card.
✓ The Data Card icon reappears on the display and the memory card can be used again.

Note: If using a different memory card, e.g., an FW Update Card, these steps can be omitted.

Connection to PC





Connect the memory card to the computer via micro USB cable.



1 Micro USB port

2 System connection Stratos Multi

Memory Card Types

Icon	Card Type (original accessory)	Purpose
	Data Card ZU1080-S-N-D	Data recording (e.g., configuration, parameter sets, logbook, measurement recorder data). When data is being transmitted, the icon flashes. The Data Card can be used in conjunction with the following TAN options: FW-E102 Parameter Sets 1-5 FW-E103 Measurement Recorder FW-E104 Logbook
	FW Update Card ZU1080-S-N-U	Firmware update for function expansion (TAN option FW-E106). The previous firmware is replaced by the current version. General data cannot be stored on this memory card.
	FW Repair Card ZU1080-S-N-R	Free firmware repair in case of device errors. TAN option FW-E106 is not required here. General data cannot be stored on this memory card.
	Custom FW Update Card ZU1080-S-N-S	Customer-specific FW versions Firmware update for function expansion (TAN option FW-E106). Older firmware versions can be stored on a Custom FW Update Card. General data cannot be stored on this memory card.
	Custom FW Repair Card ZU1080-S-N-V	Customer-specific FW repair versions For Custom Cards, the firmware version can be chosen as required, e.g., to set the firmware of all existing devices to a uniform version proven in operation.

Firmware Update with FW Update Card

A firmware update with FW Update Card requires TAN option FW-E106.

→ *Firmware Update (FW-E106)*, p. 204

Firmware Repair with FW Repair Card

Note: For troubleshooting with the FW Repair Card, the Firmware Update add-on function must not be active.

01. Open the enclosure.
02. Insert the FW Repair Card into the memory card slot in the front unit.
03. Close the enclosure.
04. The automatic update process starts and runs automatically.

Specifications

Memory Card	Accessory for additional functions (firmware update, measurement recorder, logbook)
Memory size	32 MB
Logbook	In the case of exclusive use: 20,000 entries and more
Measurement recorder	In the case of exclusive use: 20,000 entries and more
Connection to PC	Micro USB
Connection to device	Plug-in connection
Communication	USB 2.0, high-speed, 12 Mbit/s Data Card, MSD (mass storage device) FW Update Card, FW Repair Card: HID (human interface device)
Dimensions	L 32 mm x W 12 mm x H 30 mm

13.2 ZU1072 RJ45 Socket

Intended Use

The RJ45 socket makes it possible to connect an Ethernet cable to Stratos Multi E471N. It is screwed into the bottom side of the housing, replacing one of the cable glands.

Sectional View

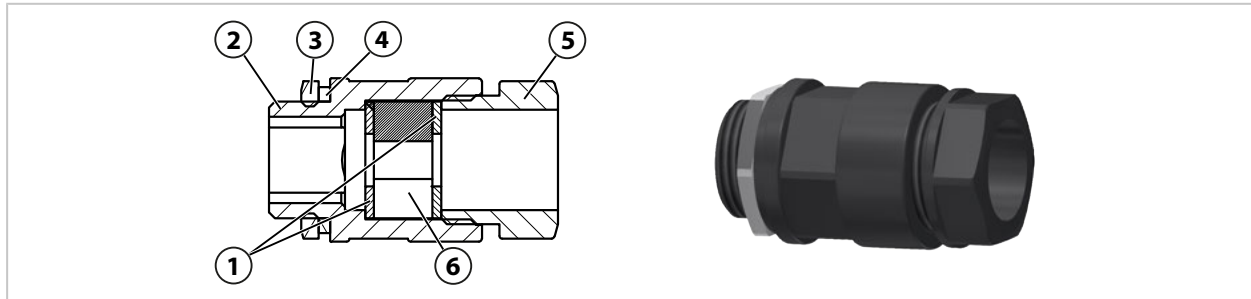

1 Washer	4 Connection thread gasket EADR 20
2 Housing	5 Pressure piece
3 Locknut EMMU 20	6 Split sealing insert GFD 25-01-065

Specifications

Materials	
Housing, pressure piece	PA6.6 – GF30 sw
Washer	POM, natural
Connection thread gasket EADR 20	EPDM, M20
Split sealing insert GFD 25-01-065	EPDM
Locknut EMMU 20	Brass, nickel-plated, M20
Min. cable diameter	4 mm
Max. cable diameter	6.5 mm
Number of cables	1
Max. connector dimensions (W x H)	15 mm x 11.2 mm
Color	Black
Dimensions	28 mm x 28 mm x 49.5 mm
Weight	Approx. 26 g
Ambient temperature	-20 ... 55 °C (-4 ... 131 °F)
Degree of protection	IP67

Typical Applications

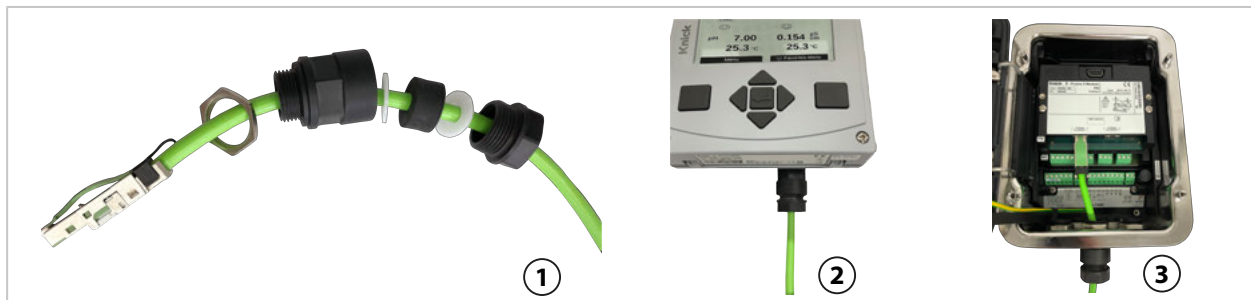

1 Socket with cable	3 Socket on Protos II with PN4400-095
2 Socket on Stratos Multi	

13.3 ZU1073 Adapter Cable RJ45/M12 D-Type

Intended Use

The adapter cable connects an RJ45 socket on the Stratos Multi E471N to a D-coded M12 socket and is used for Ethernet data transmission.

Connection Diagram

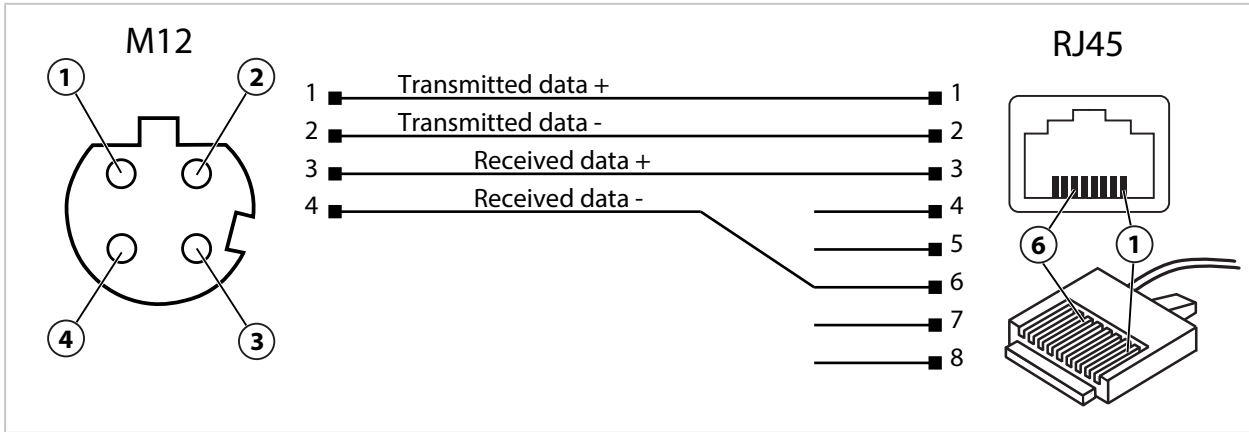

Specifications

Category	CAT 5
Material	PUR, polyolefin
Cable diameter	6.7 mm
Length	0.3 m
Ambient temperature	-20 ... 55 °C (-4 ... 131 °F)
Protection	IP67

Typical Applications

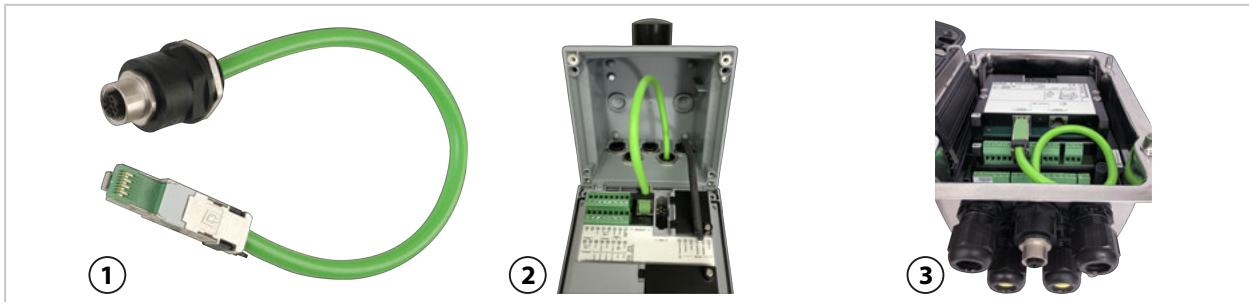

1 Adapter cable RJ45/M12 D-type
2 Stratos Multi

3 Protos II 4400 with PN4400-095

14 TAN Options

The functions described in the following are available after the corresponding TAN option is activated.
→ *Option Activation*, p. 47

Add-on Functions (TAN Options)	Order no.
pH Buffer Table: Entry of individual buffer set → <i>pH Buffer Table: Entry of Individual Buffer Set (FW-E002)</i> , p. 186	FW-E002
Current characteristic → <i>Current Characteristic (FW-E006)</i> , p. 187	FW-E006
Concentration determination for use with conductivity sensors → <i>Concentration Determination (FW-E009)</i> , p. 187	FW-E009
Oxygen measurement in low oxygen concentrations (Specifications → <i>Oxygen</i> , p. 215	FW-E015
Pfudler sensors → <i>Pfudler Sensors (FW-E017)</i> , p. 192	FW-E017
Calculation blocks → <i>Calculation Blocks (FW-E020)</i> , p. 194	FW-E020
Digital ISM pH/ORP and amperometric ISM oxygen sensors → <i>Digital ISM-Sensors (FW-E053)</i> , p. 198	FW-E053
Parameter sets 1–5 → <i>Parameter Sets 1-5 (FW-E102)</i> , p. 199	FW-E102
Measurement recorder → <i>Measurement Recorder (FW-E103)</i> , p. 201	FW-E103
Logbook → <i>Logbook (FW-E104)</i> , p. 203	FW-E104
Firmware update → <i>Firmware Update (FW-E106)</i> , p. 204	FW-E106

14.1 pH Buffer Table: Entry of Individual Buffer Set (FW-E002)

For the buffer table that can be entered, the FW-E002 add-on function must be activated in the device with a TAN. → *Option Activation*, p. 47

An individual buffer set with 3 buffer solutions can be entered. To do so, the nominal, temperature-corrected buffer values for the temperature range 0 ... 95 °C (32 ... 203 °F) are entered in increments of 5 °C (9 °F). This buffer set is available in addition to the default standard buffer solutions under the name "Table".

Conditions for the Specifiable Buffer Set:

- This should be in the pH 0 ... pH 14 range.
- The difference between two adjacent pH values (distance 5 °C) of the same buffer solution may be no more than 0.25 pH units.
- The values of buffer solution 1 must be smaller than those of buffer solution 2.
- The distance of values with the same temperature to both buffer solutions must be larger than 2 pH units. If the entry is faulty, an error message will be output.

The pH value at 25 °C (77 °F) is always used for buffer display during calibration.

The settings are made in the **Buffer Table** submenu:

Parameter Setting ▶ **System Control** ▶ **Buffer Table**

01. Select the buffer to be entered. In ascending order (e.g., pH 4, 7, 10), 3 complete buffer solutions must be entered. Minimum distance between buffers: 2 pH units.
02. Enter nominal buffer values and all buffer values as temperature-corrected values and confirm with **enter**.

The individual buffer sets are selected in the menu:

Parameter Setting ▶ **[I] [II] ... pH** ▶ **Cal Presettings**

Calibration Mode : "Calimatic"

Buffer Set : "Table"

14.2 Current Characteristic (FW-E006)

For the current characteristic that can be entered, the FW-E006 add-on function must be activated in the device via TAN. → *Option Activation, p. 47*

Assignment of output current to the process variable in increments of 1 mA.

The settings are made under:

Parameter Setting ▶ Inputs/Outputs ▶ Current Outputs

01. Open the Current Output I1 or Current Output I2 submenu.

02. Specify Usage : "On"

03. Specify a Process Variable .

04. Characteristic : "Table"

✓ The Table submenu is displayed.

05. Open the Table submenu.

06. Enter the values for the process variable.

The process variable must always be assigned ascending or descending.

14.3 Concentration Determination (FW-E009)

For concentration determination, the FW-E009 add-on function must be activated in the device via TAN. → *Option Activation, p. 47*

The measured conductivity and temperature values are used to determine the substance concentration in percent by weight (wt%) for H₂SO₄, HNO₃, HCl, NaOH, NaCl and Oleum.

Prerequisites for Concentration Determination

On the following pages, the conductivity curve depending on substance concentration and media temperature is presented.

For reliable concentration determination, the following boundary conditions be adhered to:

- The concentration calculation is based on the presence of a pure binary mixture (e.g. water-hydrochloric acid). If other dissolved substances like salts are present, the resulting concentration values are falsified.
- In areas of small curve gradients (e.g., at area boundaries), small changes in the conductivity value can correspond to large changes in concentration. This can potentially lead to an unsteady display of the concentration value.
- Because the concentration value is calculated from the measured conductivity and temperature values, precise temperature measurement is very important. For this reason, thermal equilibrium between the conductivity sensor and process medium must be maintained.

The settings are made in the Concentration submenu:

Parameter Setting ▶ [I] [II] ... Cond(I) ▶ Concentration

01. Concentration : On

02. Select the Medium :

NaCl (0-28%), HCl (0-18%), NaOH (0-24%), H₂SO₄ (0-37%), HNO₃ (0-30%), H₂SO₄ (89-99%), HCl (22-39%), HNO₃ (35-96%), H₂SO₄ (28-88%), NaOH (15-50%), Oleum (12-45%), table

You can set parameters for concentration values limits for warning and failure messages:

Parameter Setting ▶ [I] [II] ... Cond(I) ▶ Messages ▶ Concentration Messages → *Messages, p. 85*

Specifying a Special Concentration Solution for Conductivity Measurement

For a customer-specific solution, 5 concentration values A-E can be entered in a matrix with 5 default temperature values 1-5. First enter the 5 temperature values, and then the associated conductivity values for each of the concentrations A-E.

These solutions are available in addition to the default standard solutions under the name "Table".

The settings are made under **System Control** in the **Concentration Table** submenu:

Parameter Setting ▶ **System Control** ▶ **Concentration Table**

01. Enter temperature 1 to 5.

02. Enter values for temperature-corrected concentration A-E.

Note: The temperature values must be rising (Temp. 1 is the lowest, Temp. 5 the highest temperature).

The concentration values must be rising (Conc. A is the lowest, conc. E the highest concentration). The table values A1 ... E1, A2 ... E2, etc. must all be rising within the table or all falling. Points of inflection are not allowed.

Incorrect table entries are indicated by an exclamation point in a red triangle.

The table used is a 5x5 matrix:

	Conc. A	Conc. B	Conc. C	Conc. D	Conc. E
Temp. 1	A1	B1	C1	D1	E1
Temp. 2	A2	B2	C2	D2	E2
Temp. 3	A3	B3	C3	D3	E3
Temp. 4	A4	B4	C4	D4	E4
Temp. 5	A5	B5	C5	D5	E5

The concentration table is selected in the menu:

Parameter Setting ▶ **[I] [II] ... Cond(I)** ▶ **Cal Presettings**

Calibration Mode : "Automatic"

Cal Solution : "Table"

14.3.1 Concentration Curves

Conductivity [mS/cm] versus substance concentration [wt%] and media temperature [°C]

Sodium Chloride Solution NaCl

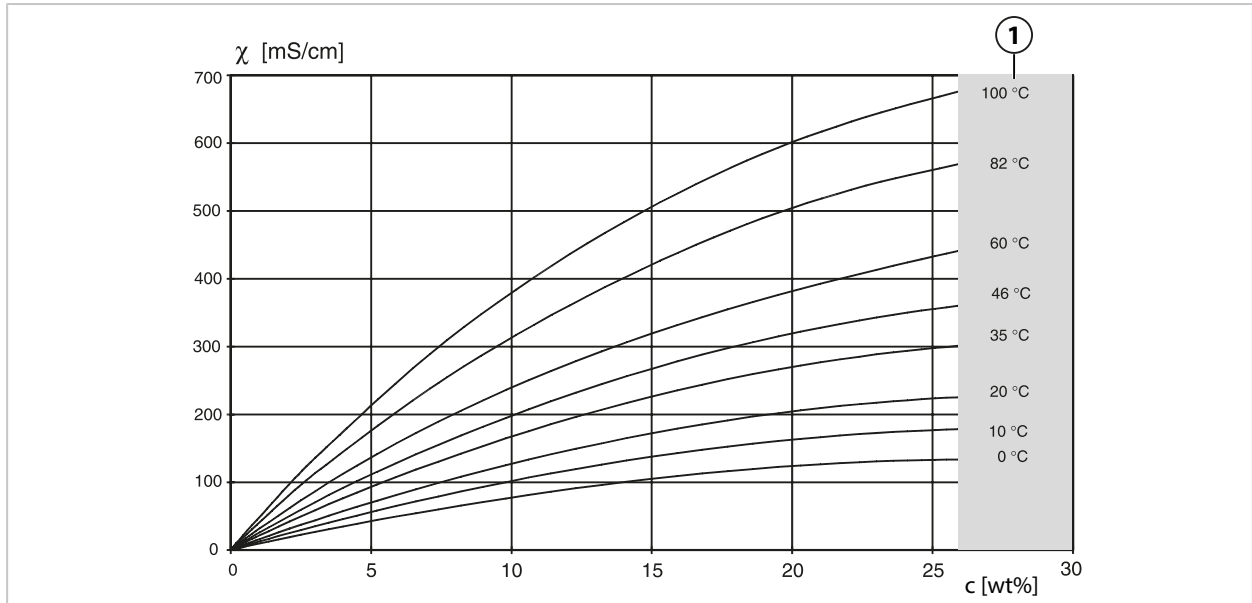

1 Range within which concentration determination is not possible.

Hydrochloric Acid HCl

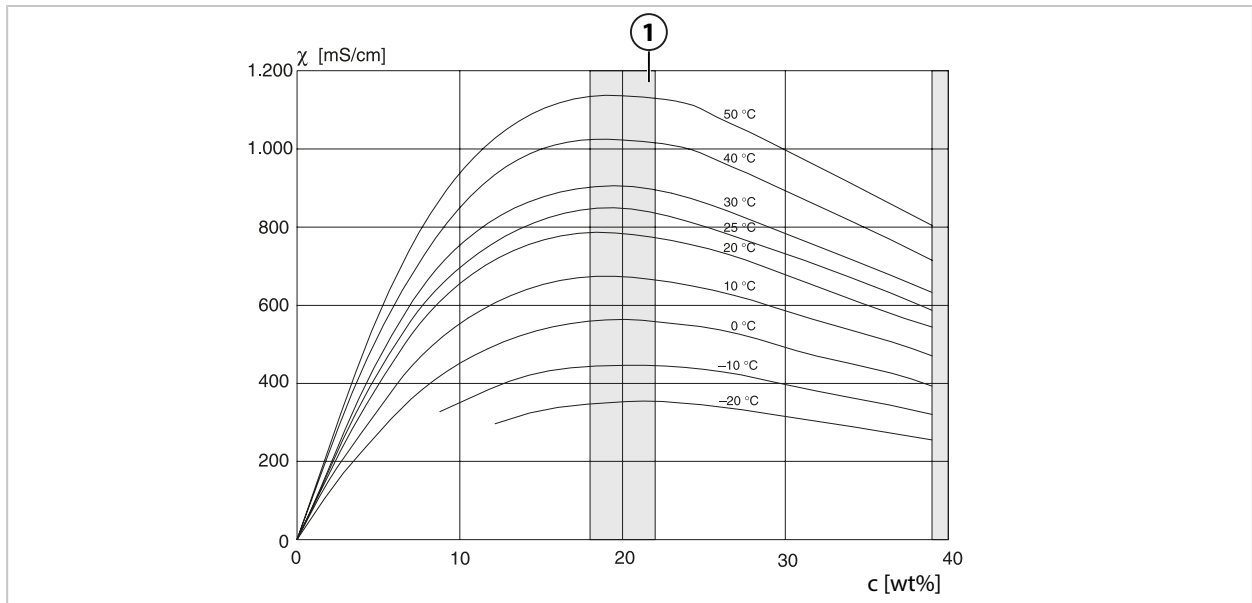

1 Range within which concentration determination is not possible.

Caustic Soda Solution NaOH

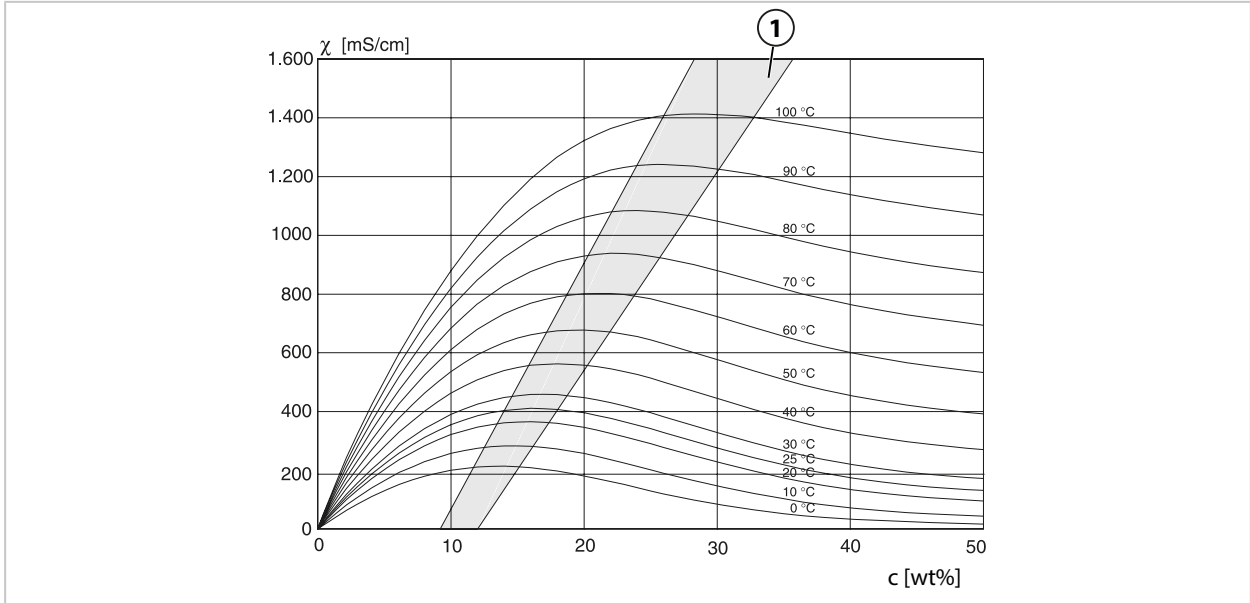

1 Range within which concentration determination is not possible.

Sulfuric Acid H₂SO₄

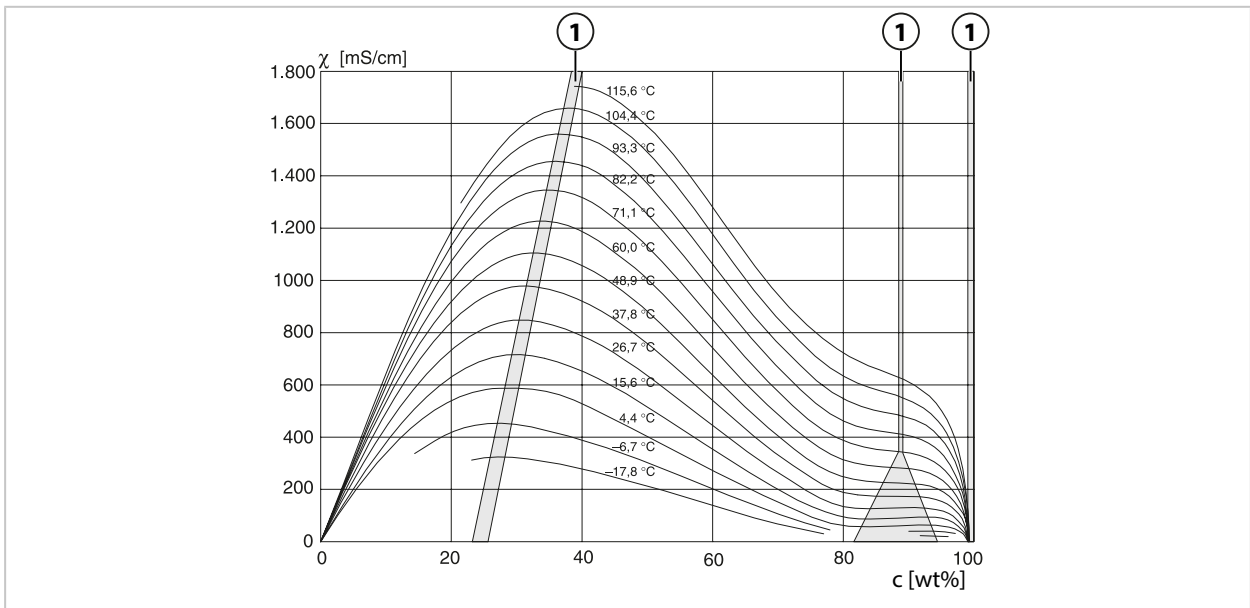

1 Range within which concentration determination is not possible.

Nitric Acid HNO₃

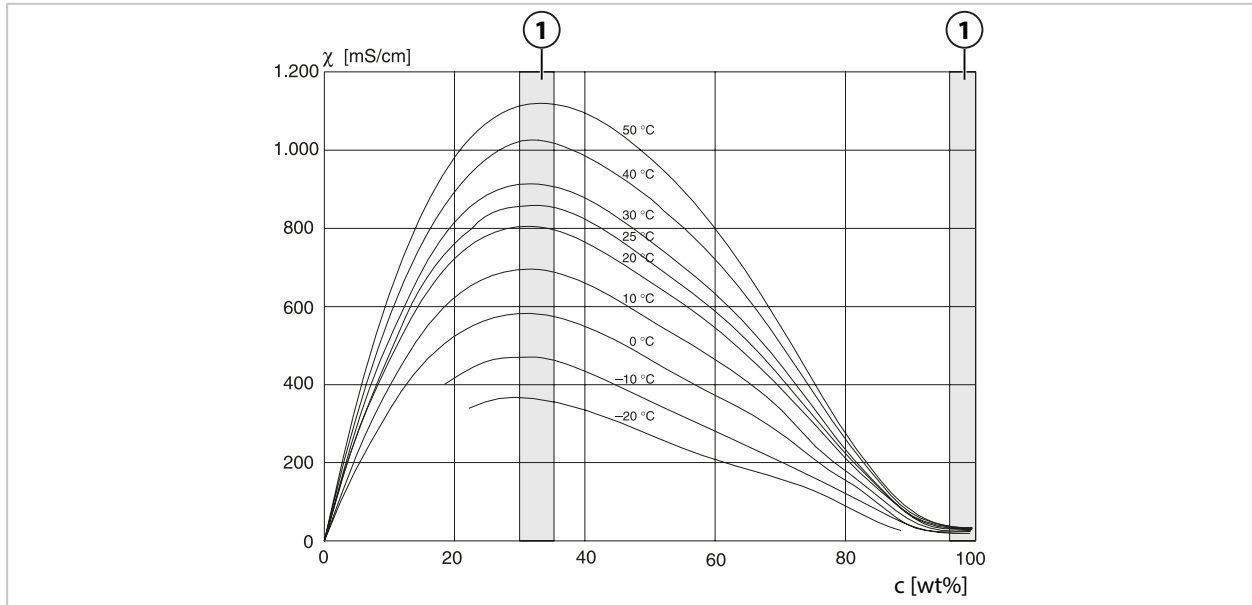

1 Range within which concentration determination is not possible.

Oleum H₂SO₄•SO₃

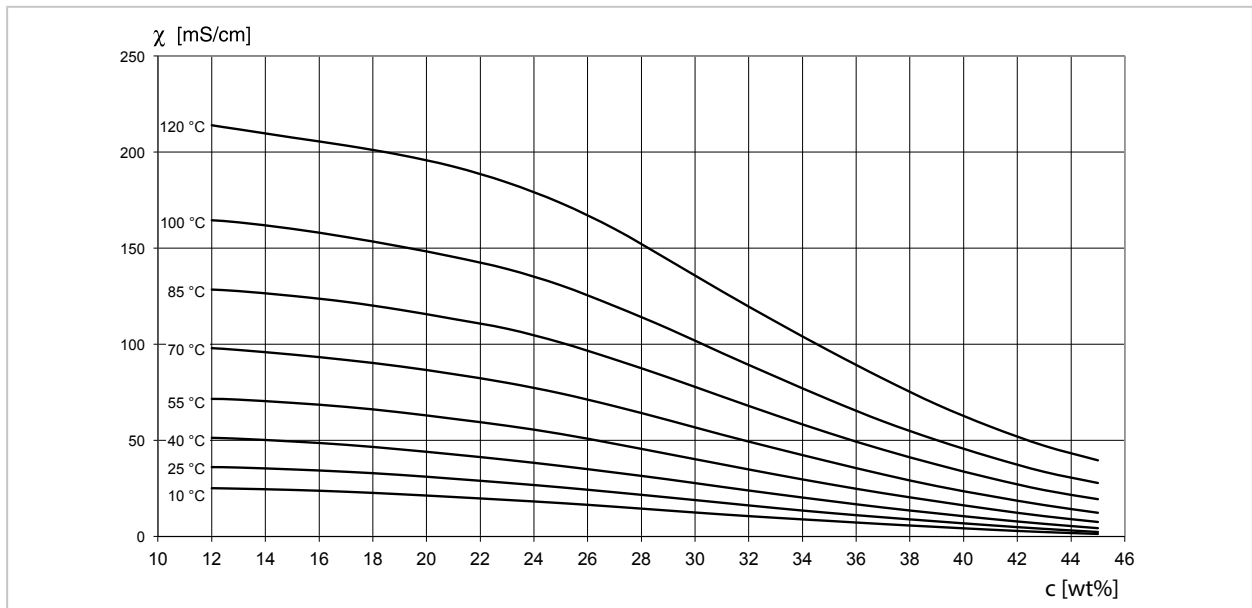

1 Range within which concentration determination is not possible.

14.4 Pfudler Sensors (FW-E017)

This option enables simultaneous pH value and temperature measurement with Pfudler pH sensors or pH sensors with a zero point and/or a slope deviating from pH 7, e.g., pH sensors with a zero point at pH 4.6.

The FW-E017 add-on function must be activated in the device via TAN for this purpose.

→ *Option Activation, p. 47*

Do the following before measurement if using analog sensors:

01. Select the sensor type used:

Parameter Setting ▶ [II] Analog pH ▶ Sensor Data → *Sensor Data, p. 67*

02. Enter the nominal zero point and the nominal slope data supplied by the sensor manufacturer:

Parameter Setting ▶ [II] Analog pH ▶ Sensor Data ▶ Sensor Monitoring Details

03. Select parameters.

04. Monitoring: "Individual"

- ✓ The values for "Nominal", "Min." and "Max." can be entered.
For default values for "Auto" selection, see table below.

05. Select "Data Entry" calibration mode:

Calibration ▶ [II] Analog pH

- ✓ The pH_{is} value for the isothermal intersection point can be entered.

06. If required, further calibrations can subsequently be performed. The pH_{is} value entered in "Data Entry" calibration mode remains stored.

Note: When a Pfudler enamel electrode is connected, the data is read from the sensor or set to the standard values. No menu entries are required; they are therefore deactivated.

The nominal values for zero point and slope are required to ensure that the sensor monitoring and calibration functions (Sensoface, Calimatic) operate as intended. They do not replace the need for adjustment (calibration).

Default Values for Slope, Zero Point, Sensocheck Reference Electrode

Parameter Setting ▶ [II] Analog pH ▶ Sensor Data ▶ Sensor Monitoring Details :

Monitoring: "Auto"

Selected sensor type	Pfudler Standard	Pfudler Diff.	Glass El. Diff.
Nom. slope	59.2 mV/pH	59.2 mV/pH	59.2 mV/pH
Nom. zero point	pH 1.50	pH 10.00	pH 7.00
Sensocheck reference electrode	500 kΩ	30 MΩ	120 MΩ

Typical Values

These values are for guidance only. The exact values are supplied by the sensor manufacturer.

Sensor	Pfudler enamel sensors (Pfudler specifications)	Sensors with absolute pH measurement and Ag/AgCl reference system	Sensors with absolute pH measurement and Ag/Ac (silver acetate) reference system	Differential pH sensors
Nom. slope	55 mV/pH	55 mV/pH	55 mV/pH	55 mV/pH
Nom. zero point	pH 8.65	pH 8.65	pH 1.35	pH 7 ... 12
pH_{is}	pH 1.35	pH 1.35	pH 1.35	pH 3.00

Note: Refer to the user manual for the respective sensor to obtain more information on functioning, assembly, calibration (adjustment, and configuration).

Isothermal Intersection Point

The isothermal intersection point is the intersection of two calibration lines plotted for two different temperatures. The coordinates of this intersection are labeled V_{is} and pH_{is} . The isothermal intersection point remains constant for each sensor.

It may cause temperature-dependent measurement errors, but they can be avoided by calibrating at the measuring temperature or at a constant, controlled temperature.

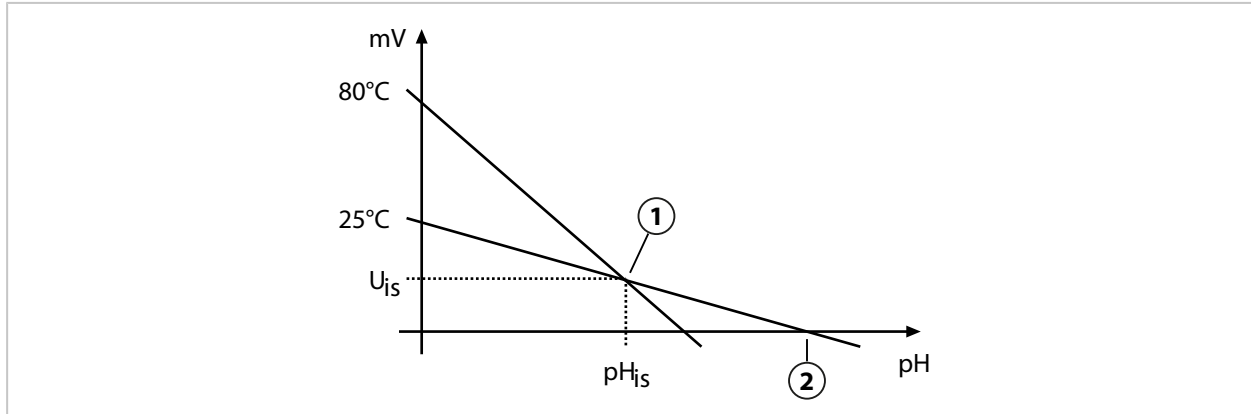

1 Isothermal intersection point

2 Zero point

14.5 Calculation Blocks (FW-E020)

After activating TAN option FW-E020, two calculation blocks are available to calculate the existing process variables to new variables. → *Option Activation, p. 47*

The general device stat (NAMUR signals) is also taken into account.

The existing process variables are used to calculate:

- Measured value difference (selection dependent on sensor)
- Ratio
- Passage
- Rejection
- Deviation
- pH value calculation from dual conductivity measurement (see below)
- User-Spec (DAC): User specification

All new variables generated by the calculation blocks can be output at the current outputs and on the measurement display.

Activating and Setting Parameters for a Calculation Block

Requirements

- At least two sensors are connected.
- TAN option FW-E020 is activated.

Steps

01. Parameter Setting ▶ System Control ▶ Calculation Blocks
02. Select combinations of process variables.

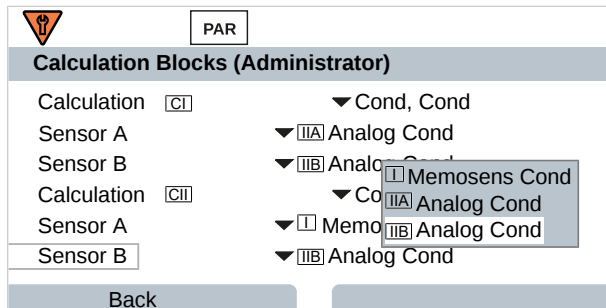

03. Parameter Setting main menu: 2x **left softkey: Back**
04. Use the **arrow keys** to scroll downwards and select a calculation block.

Calculation blocks are displayed in parameter setting like modules and have the extension [CI] or [CII]:

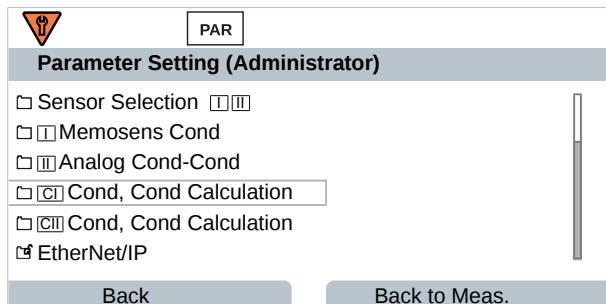

05. Parameter setting for calculation block.

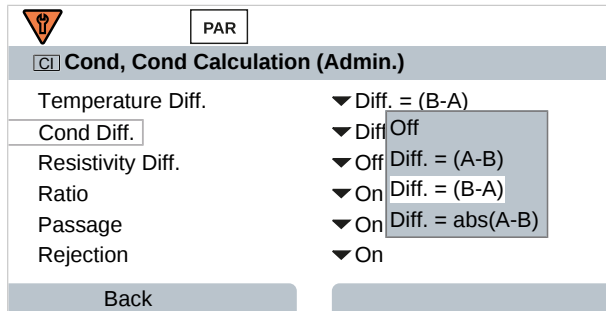

Process Variable Combinations in the Calculation Block

Process Variable Combinations	Calculation Block	Variables Calculated by the Calculation Block
pH + pH	pH/pH	Temperature difference °C
		pH value difference pH
		ORP difference mV
		pH-voltage difference mV
Cond + Cond CondI + CondI Cond + CondI	Cond/Cond	Temperature difference °C
		Conductivity difference S/cm
		Resistivity difference Ω*cm
		Ratio S/cm [%]
		Passage S/cm [%]
		Rejection S/cm [%]
		Deviation S/cm [%]
		pH Value pH
Oxy + Oxy	Oxy/Oxy	Saturation %Air difference %Air
		Saturation %O ₂ difference %O ₂
		Conc. (liquid) difference mg/l
		Conc. (gas) difference %vol
		Temperature difference °C

Calculation Formulas

Process Variable	Calculation Formula	Range	Span
Difference (can be selected in the menu)	Diff. = A - B	Process variable	Process variable
	Diff. = B - A		
	Diff. = abs(A - B)		
Ratio (only Cond/Cond)	Cond A/Cond B	0.00 ... 199.9	0.10
Passage (only Cond/Cond)	Cond B/Cond A × 100	0.00 ... 199.9	10%
Rejection (only Cond/Cond)	(Cond A - Cond B)/Cond A × 100	-199.9 ... 199.9	10%
Deviation (only Cond/Cond)	(Cond B - Cond A)/Cond A × 100	-199.9 ... 199.9	10%

In the Cond/Cond calculation, it is possible to determine a pH value from the measured conductivity values. The settings are made in the **pH Value** submenu:

Parameters that can be set for pH value calculation

Parameter Setting ▶ [CI/II] Calculation Cond/Cond ▶ pH Value	
Usage	Off, pH-VGB-S-006, pH-Variable
If you select "pH-VGB-S-006":	
Alkalizing Agent	NaOH: $11 + \log((\text{COND A} - \text{COND B} / 3) / 243)$ NH ₃ : $11 + \log((\text{COND A} - \text{COND B} / 3) / 273)$ LiOH: $11 + \log((\text{COND A} - \text{COND B} / 3) / 228)$
Alkalizing	Off, on
Ion Exchanger	Off, on
Filter Volume	Enter filter volume in l
Resin Capacity	Enter resin capacity
Capacity Factor	Enter capacity factor in %
If you select "pH-Variable":	
Entry of coefficient C, factor 1 ... 3	

Typical Application

pH Value Measurement of Boiler Feed Water in Power Plant Technology

In the case of monitoring boiler feed water in power plants, a dual conductivity measurement can be used to calculate the pH value under certain conditions. To do so, the conductance of the boiler feed water is measured upstream and downstream of the ion exchanger. This frequently used method of indirect pH value measurement is relatively low-maintenance and has the following advantages:

An unadulterated pH value measurement in ultrapure water is highly critical. Boiler feed water is a low-ion medium. It requires the use of a special electrode that must be continuously calibrated and typically does not have a long useful life.

Two sensors are used for conductivity measurement upstream and downstream of the ion exchanger. The pH value is determined from both of the calculated measured conductivity values.

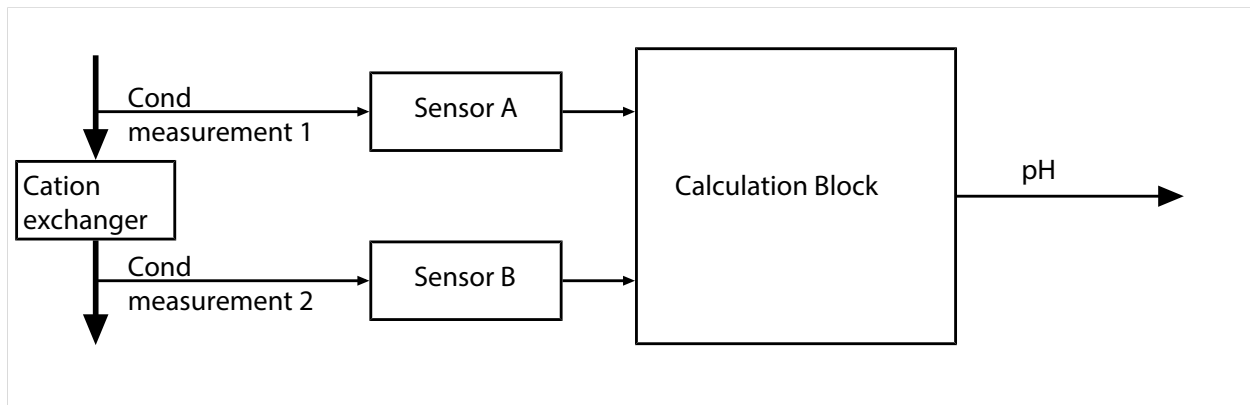

Calculating the concentration of caustic soda solution/the pH value:

$$c(\text{NaOH}) = (\text{Cond1} - \frac{1}{3} \text{Cond2}) / 243$$

$$\text{pH} = 11 + \log[c(\text{NaOH})]$$

Recommended pH ranges:

10 ± 0.2 for < 136 bar operating overpressure or

9.5 ± 0.2 for > 136 bar operating overpressure

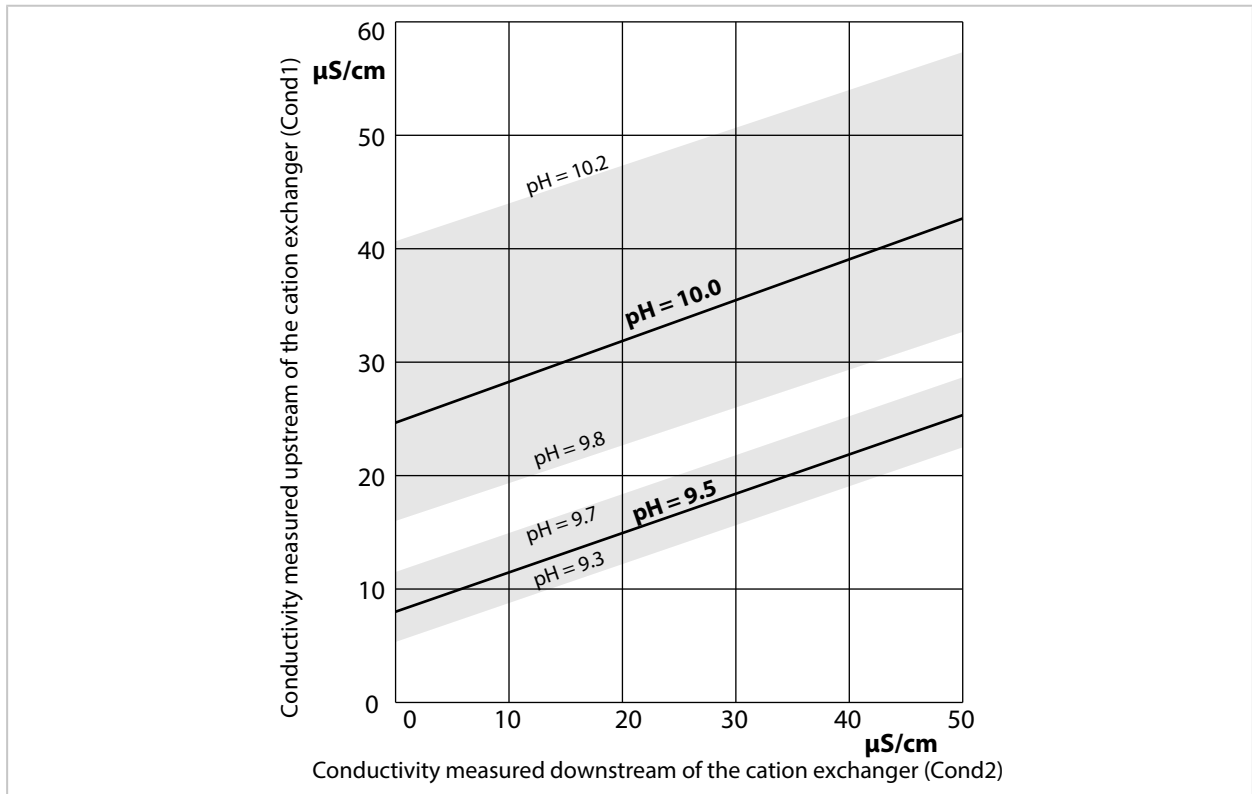

Conditioning the boiler water in natural circulation boilers with sodium hydroxide. Relationship between the pH value and the conductivity measured upstream or downstream of the cation exchanger.

Source: Appendix to VGB Guideline for boiler feed water, boiler water and vapor from steam generators above 68 bar permissible operating pressure (VGB-R 450 L, 1988 edition)

See also

→ *Dual Conductivity Measurement, p. 93*

14.6 Digital ISM-Sensors (FW-E053)

This option enables digital ISM sensors to be used for measuring pH, ORP and oxygen (amperometric). The FW-E053 add-on function must be activated in the device via TAN for this purpose.

→ *Option Activation, p. 47*

Identifying an ISM Sensor

ISM sensors have an “electronic datasheet”. The permanent factory data (manufacturer, sensor description) and key sensor-related parameters are automatically transferred to the Stratos Multi.

Sensor Monitoring



Information around predicative maintenance can be entered into the sensor from the device. This includes the maximum permissible number of CIP/SIP or autoclaving cycles, for example. The settings are made in Parameter Setting:

Parameter Setting ▶ [II] ISM [pH] ▶ Sensor Data ▶ Sensor Monitoring Details → *pH Process Variable, p. 65*

Parameter Setting ▶ [I] ISM [Oxy] ▶ Sensor Data ▶ Sensor Monitoring Details

→ *Oxygen Process Variable, p. 96*

For every parameter, you can select whether and how off-limit values should be displayed:

Off	No message, but the parameter is still shown in the Diagnostics menu.
Failure	A failure message is shown for off-limit conditions; the corresponding NAMUR icon  is displayed. If “Display Color NE107” is set, the measurement display is shown with red backlighting.
Maintenance	A maintenance required message is shown in off-limit conditions; the corresponding NAMUR icon  is displayed. If “Display Color NE107” is set, the measurement display is shown with blue backlighting.

Calibration/Adjustment

Note: The calibration data is saved in the ISM sensor. This means that ISM sensors can be cleaned, re-conditioned, calibrated, and adjusted away from the measuring point, e.g., in a laboratory. Sensors in the system are replaced on-site by adjusted sensors.

An ISM sensor that has never been used before must be calibrated first:

01. Select Calibration ▶ [II] ISM [pH/Oxy]
02. Calibration Mode
03. First Adjustment : Yes
04. Make more settings depending on the calibration mode.
 - ✓ Calibration can be performed. → *Calibration/Adjustment, p. 112*

14.7 Parameter Sets 1-5 (FW-E102)

To use parameter sets 1-5, add-on function FW-E102 must be activated in the device via TAN.
 → *Option Activation, p. 47*

Saving a Parameter Set on the Data Card

Two parameter sets (A, B) are present in the device. Parameter set A can be saved on a Data Card. Up to 5 different parameter sets, e.g., from different device, can be saved on the Data Card.

01. **Parameter Setting** ▶ **System Control** ▶ **Parameter Sets**
02. Select the number of parameter sets.

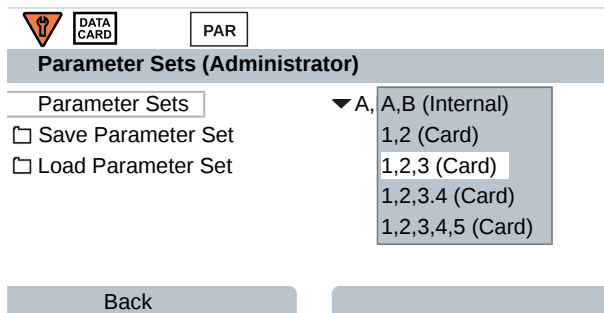

Note: As soon as parameter sets are selected on the Data Card, OK2 “Parameter Set Selection” is set to “Off”.

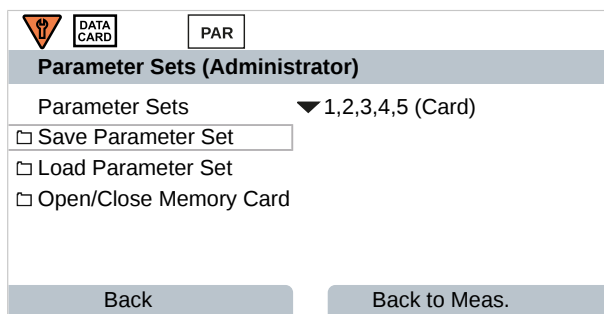

03. **Save Parameter Set** ▶ **Save to** : Select the parameter set to overwrite.

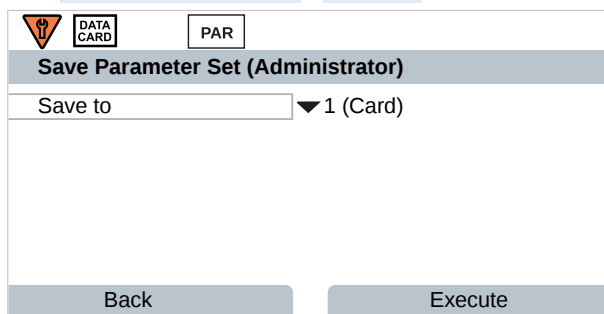

04. **Right softkey: Execute**

✓ The parameter set is saved as a file on the Data Card.

Loading a Parameter Set from the Data Card

A parameter set saved on the Data Card (1, 2, 3, 4 or 5) can be loaded to the device-internal parameter set A.

01. **Parameter Setting** ▶ **System Control** ▶ **Parameter Sets**

02. Select the number of parameter sets.

Note: As soon as parameter sets are selected on the Data Card, OK2 "Parameter Set Selection" is set to "Off".

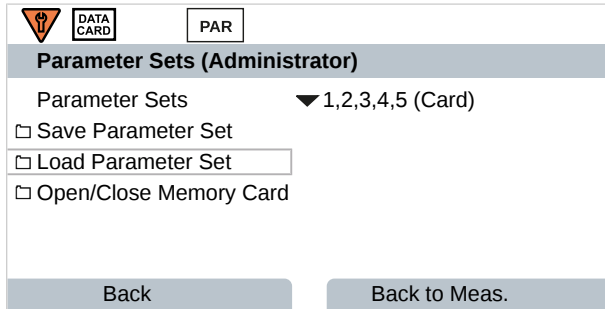

Parameter Sets (Administrator)

Parameter Sets ▼ 1,2,3,4,5 (Card)

Save Parameter Set

Load Parameter Set

Open/Close Memory Card

Back Back to Meas.

03. **Load Parameter Set** ▶ **Load from** : Select the parameter set to load.

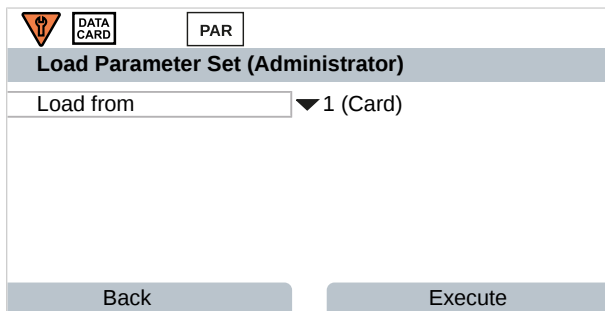

Load Parameter Set (Administrator)

Load from ▼ 1 (Card)

Back Execute

04. **Right softkey: Execute**

✓ The parameter set is saved as parameter set A in the device.

14.8 Measurement Recorder (FW-E103)

To use the measurement recorder, add-on function FW-E103 must be activated in the device via TAN.
 → *Option Activation, p. 47*

The measurement recorder logs measured values and additional values depending on its parameter setting.

The following are adjustable:

- Process variables to be displayed
- Start and end values for the process variable to be recorded
- Time base (recording interval, selectable from 10 s to 10 h)

In addition, the time axis can be stretched by a factor of 10 with the “zoom function”.

Setting the Measurement Recorder Parameters

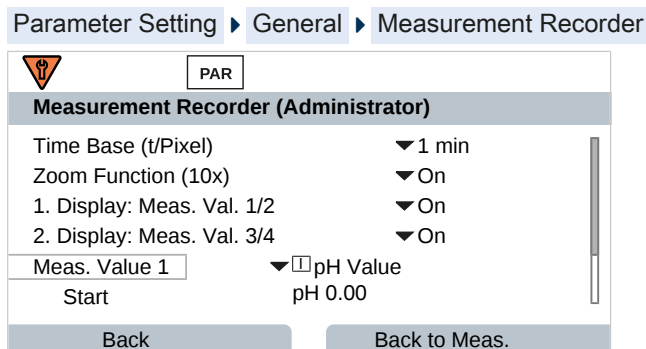

Recording starts as soon as the parameters are set.

Displaying Measurement Recorder Data

Diagnostics > Measurement Recorder

The measurement recorder saves all the entries in a file. The last 100 entries are graphically presented on the display of the device.

Up to 4 process variable are displayed. The 4 process variable are distributed to 2 measurement recorders. Use the **right softkey** to toggle between the measurement recorders.

For fast changes, the zoom function is automatically switched on. It begins several pixels before the event. This makes process variable fluctuations traceable in detail.

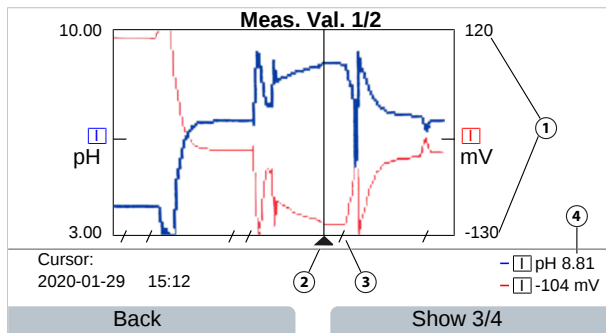

- | | |
|--|--|
| <p>1 Displayed range
Start and end value of the process variable</p> <p>2 Cursor
(shift with arrow keys)</p> | <p>3 Areas of fast process variable changes (automatic zoom function) are marked by lines.</p> <p>4 Current measured values at cursor position</p> |
|--|--|

Deleting Measurement Recorder Data

01. Parameter Setting ▶ System Control ▶ Measurement Recorder
02. Clear measurement recorder: Select "Yes".
03. Confirm with *right softkey: OK*.

Saving on the Data Card

Note: The device-internal memory has a limited memory capacity and continuously overwrites the oldest data sets after reaching maximum memory capacity. For recordings that take a long time, a Data Card is absolutely necessary. The data saved on the Data Card can be read out and evaluated with a computer.

Using the Data Card → *Memory Card, p. 181*

Activate the Data Card to save the recorder data:

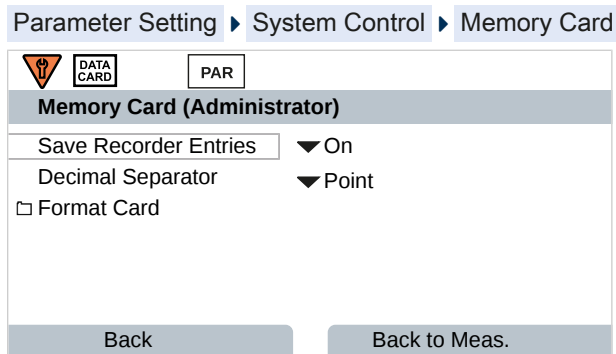

A new file is created for each day. The data is encoded in the file name.

Example of a file generated on a Data Card:

\RECORDER\R_YYMMDD.TXT

Recorder data from YYMMDD (YY = year, MM = month, DD = day)

Data is recorded as an ASCII file with the data extension .TXT and the individual columns are separated with tabs (TAB). This makes the file readable in word processing programs or spreadsheet programs like Microsoft Excel. A "Device Info" consisting of the device type, serial number and tag number is always written each time the Data Card is inserted into the memory card slot. This means that a Data Card can also be used in order to collect the measurement recorder data of multiple devices.

The entries in the recorder file have the following meaning:

TIME STAMP	Time stamp of the recorder entry
CH1/2/3/4	1st/2nd/3rd/4th recorder channel with measured value and unit of measurement
Z1/2	1st/2nd additional value and unit of measurement
MAINT	"Maintenance Required" NAMUR signal
HOLD	"Function Check/HOLD" NAMUR signal
FAIL	"Failure" NAMUR signal

14.9 Logbook (FW-E104)

To record the logbook entries in a file, the FW-E104 add-on function must be activated in the device via TAN. → *Option Activation, p. 47*

See also

→ *Logbook, p. 47*

Saving on the Data Card

Using the Data Card → *Memory Card, p. 181*

When using a Data Card, 20,000 entries or more can be recorded on the Data Card depending on its memory capacity.

Activate the Data Card to save the recorder data:

Parameter Setting ▶ System Control ▶ Memory Card

 DATA CARD
PAR

Memory Card (Administrator)

Save Logbook Entries ▼ On

Decimal Separator ▼ Point

Format Card

Back
Back to Meas.

Each month, a new ASCII file with the file extension .TXT is created. The date is encoded in the file name:

\LOGBOOK\L_YYMM00.TXT
(YY = year, MM = month)

The individual columns are separated by tabs. This makes the file readable in word processing programs or spreadsheet programs like Microsoft Excel. A "Device Info" consisting of the device type, serial number BASE and tag number is always written each time the Data Card is inserted into the memory card slot. This means that a Data Card can also be used in order to collect the logbook data of multiple devices.

14.10 Firmware Update (FW-E106)

Note: First check whether a firmware update is relevant for your device.

For the firmware update, the FW-E106 add-on function must be activated in the device via TAN.

→ *Option Activation, p. 47*

Stratos Multi has a standard micro controller and a micro controller for communication. Firmware updates can be executed for both micro controllers. The firmware files are identified as follows:

- Standard microcontroller:
Firmware: xx.xx.xx. Build xxxxx
- Communication microcontroller:
BASE Firmware (APP): xx.xx.xx. Build xxxxx
BASE Firmware(COM): xx.xx.xx

NOTICE! For a correct firmware update, adhere to the order:

1. Firmware, 2. BASE Firmware (APP), 3. BASE Firmware (COM)

NOTICE! During a firmware update, the device is not operable. The outputs are in an undefined state. The parameter settings must be verified after a firmware update.

Note: Before a firmware update for the standard micro controller, we recommend saving the previous version on the FW Update Card.

Executing a Firmware Update with FW Update Card

Using the FW update card → *Memory Card, p. 181*

01. Open the enclosure.
02. Insert the FW Repair Card into the memory card slot in the front unit.
 - ✓ The FW Update Card icon is shown in the display.
03. Close the enclosure.
04. Save the firmware (FW) previously installed on the device if required:
 - Menu Selection ▶ Parameter Setting ▶ System Control ▶ Firmware Update ▶ Save Firmware
 - Start the backup with **right softkey: Start**.
 - ✓ When the firmware update has finished, the device will return to measuring mode.
05. Load the firmware update:
 - Menu Selection ▶ Parameter Setting ▶ System Control ▶ Firmware Update ▶ Update Firmware
06. Select the correct version using the arrow keys:
Firmware, BASE Firmware (APP), BASE Firmware (COM)
07. Confirm with **enter**.
08. Start the firmware update with **right softkey: Start**.
 - ✓ The firmware update runs.
09. Restart the device by pressing the **right softkey: Restart**.
10. Run BASE Firmware (APP) update (procedure as from step 05 on).
11. Run BASE Firmware(COM) update (procedure as from step 05 on).
12. When the updates have finished, open the enclosure and remove the FW Update Card.
13. Close the enclosure and screw it together.
14. Check parameter settings.

15 Specifications

15.1 Power Supply (Power)

Power supply, terminals 17, 18	80 V (- 15%) ... 230 (+ 10%) V AC; approx. 15 VA; 45 ... 65 Hz 24 V (- 15%) ... 60 (+ 10%) V DC; 10 W
	Overvoltage category II, class II, pollution degree 2
Test voltage	Type test 3 kV AC 1 min after moisture pre-treatment Routine test 1.4 kV for 2 s

15.2 Connections

15.2.1 Inputs (SELV, PELV)

Sensor input 1	
Function	Connect Memosens/optical sensors (SE740), galvanically isolated
Data in/out	Asynchronous interface RS-485, 9600/19200 Bd
Power supply	3.08 V (3.02 ... 3.22 V)/10 mA, $R_i < 1 \Omega$, short-circuit-proof
Sensor input 2	
Function	Measuring module connection (for Memosens, analog or ISM ¹⁾ sensors), galvanically isolated
Data in/out	Asynchronous interface RS-485, 9600 Bd
Power supply	3.08 V (3.02 ... 3.22 V)/6 mA, $R_i < 1 \Omega$, short-circuit-proof
Input OK1	
Description	Optocoupler input, galvanically isolated
Function	Toggle between parameter set A/B, flow measurement, function check
Parameter set selection	Switch input 0 ... 2 V (AC/DC) Parameter Set A Switch input 10 ... 30 V (AC/DC) Parameter Set B Control current 5 mA
Flow	Pulse input for flow measurement 0 ... 100 pulses per second Display: 00.0 ... 99.9 l/h Message via 22 mA or relay contact

15.2.2 Outputs (SELV, PELV)

Power out	Power output, short-circuit-proof, 0.5 W, for operating sensor SE 740 Out; 3.1 V (2.99 ... 3.25 V); 14 V (12.0 ... 16.0 V); 24 V (23.5 ... 24.9 V)
Output 1, 2 Out 1, Out 2	
Output current	0/4 ... 20 mA, floating, max. load resistance to 500 Ω , galvanic connection to each other If current outputs are used, Ethernet operation and use of relay contacts are not possible.
Failure message	3.6 mA or 22 mA, adjustable
Active	Max. 11 V
Passive	Supply voltage 3 ... 24 V
Process variable	Selectable from all available process variables
Start/end of scale	Configurable within selected measuring range
Characteristic	Linear, bi-/trilinear, or logarithmic
Output filter	PT1 filter, filter time constant 0 ... 120 s
Measurement uncertainty ²⁾	< 0.25% current value + 0.025 mA

¹⁾ ISM with TAN option FW-E053

²⁾ At rated operating conditions

15.2.3 Relay Contacts

Contact REL1, REL2

Contact type	Relay contact (relay), floating
Contact rating for ohmic load	AC < 30 V _{rms} / < 15 VA DC < 30 V / < 15 W
Max. switching current	3 A, max. 25 ms
Max. continuous current	500 mA
Function	Freely adjustable: Failure, maintenance required, function check, min./max. limit value, rinse contact, parameter set B signaling, USP output, Sensoface

Alarm contact

Contact behavior	N/C (failsafe-type)
Start-up delay	0000 ... 0600 s

Rinse contact

Contact rating for ohmic load	AC < 30 V _{rms} / < 15 VA DC < 30 V / < 15 W
Max. switching current	3 A, max. 25 ms
Max. continuous current	500 mA
Contact behavior	N/C or N/O
Interval time	0.00 ... 999.00 h (0.00 h = Cleaning function disabled)
Cleaning time/Relax time	0000 ... 1999 s

Min./max. limit values

Contact type	Min./max. contacts, floating, connected to each other
Contact behavior	N/C or N/O
Start-up delay	0000 ... 9999 s
Setpoints	Inside selected measuring range
Hysteresis	Adjustable

Service functions in the Maintenance menu

Sensor monitor	Direct display of measured values from sensor (mV, temperature, resistance, ...)
Current source ¹⁾	Current specifiable for output 1 and 2 (00.00 ... 22.00 mA)
Relay test ²⁾	Manual control of relay contacts

¹⁾ Not with activated EtherNet/IP communication

²⁾ Only with activated EtherNet/IP communication

15.3 Device

Product name	Stratos Multi
Product type	E471N
Measurements	pH ORP Amperometric oxygen/optical oxygen Conductivity measurement contacting/inductive Dual conductivity measurement
2 parameter sets	Parameter sets A and B Toggle via digital control input OK1 or manually
Display	
Type	TFT color display 4.3", white backlighting
Resolution	480 x 272 pixels
Language	German, English, French, Spanish, Italian, Portuguese, Chinese, Korean, Swedish
Sensoface	Display of sensor state: Happy, neutral, sad Smiley
Mode indication	Icons for configuration and messages
Keypad	Left softkey, right softkey, arrow key (cursor), enter
Door contact	When door is open: electric signal and logbook entry, error message F039 "Door Open"
Real-time clock	Different time and date formats selectable, power reserve approx. 1 day
Enclosure	
Material	Glass fiber reinforced plastic Front unit: PBT Rear unit: PC
Degree of protection	IP66/IP67/TYPE 4X Outdoor (with pressure compensation) for closed device
Flammability	UL 94 V-0 for external parts
Weight	1.2 kg (1.6 kg incl. accessories and packaging)
Mounting	Wall, pipe, panel mounting
Color	Gray RAL 7001
Dimensions	H 148 mm, W 148 mm, D 117 mm
Panel cutout	138 mm x 138 mm in acc. with DIN 43 700
Cable glands	5 knockouts for cable glands M20 x 1.5 2 of 5 knockouts for NPT ½" or rigid metallic conduit
Terminals	
Screw terminals	For single wires and stranded wires 0.2 ... 2.5 mm ²
Tightening torque	0.5 ... 0.6 Nm
Wiring	
Stripping length	Max. 7 mm
Temperature resistance	> 75 °C (167 °F)

15.4 Ambient Conditions

Climatic class	3K5 in accordance with EN 60721-3-3
Location class	C1 in accordance with EN 60654-1
Ambient temperature, operation	-20 ... 60 °C (-4 ... 140 °F)
Ambient temperature, transport/ storage	-30 ... 70 °C (-22 ... 158 °F)
Altitude of location	Power supply max. 60 V DC as of 2000 m altitude (MSL)
Relative humidity	5 ... 95 %

15.5 Compliance

EMC	EN 61326-1, NAMUR NE 21
Emitted interference	Class A (industrial applications) ¹⁾
Immunity to interference	Industrial applications
RoHS compliance	In accordance with EU Directive 2011/65/EU
Electrical safety	In acc. with EN 61010-1, protection against electric shock through reinforced insulation of all extra-low voltage circuits against grid

15.6 Interfaces

ODVA communication protocol	EtherNet/IP
Standards	IEC 61158, IEC 61784
ODVA manufacturer ID	1593
ODVA device ID	Generic Device (43)
ODVA device name	Stratos Multi E471N
Terminals	1x RJ45
RJ45 communication	10 Mbit/s (10BASE-T), 100 Mbit/s (100BASE-TX)
Recommended cable	CAT 5, CAT 5e, CAT 6
Galvanic isolation	Shield to ground
Insulation strength	2250 V DC 250 V / 1.5 kV AC (50/60 Hz) for 60 s
Addressing	IPv4 with DHCP, BootP, Custom
RPI (Request Packet Interval)	10 to 10000 ms
System integration with EDS file	E471N-Vxxxxxx.EDS
Data: Controller output, E471N input	→ <i>Connections to the Controller, p. 109</i>
Data: Controller input, E471N output	→ <i>Connections to the Controller, p. 109</i>

¹⁾ This equipment is not designed for domestic use, and is unable to guarantee adequate protection of the radio reception in such environments.

15.7 Measurement Functions

15.7.1 pH

Memosens	
Connection	Terminals 1 ... 5 or via module MK-MS095N
Display ranges	Temperature: -20.0 ... 200.0 °C / -4 ... 392 °F
	pH value: -2.00 ... 16.00
	Redox potential: -1999 ... 1999 mV
	rH value (with pH/ORP sensor): 0 ... 42.5
Measurement uncertainty	Dependent on sensor
Analog or ISM¹⁾ sensors	
Connection	Via module MK-PH015N
Measuring ranges	Temperature: -20.0 ... 200.0 °C (-4 ... 392 °F)
	pH value: -2.00 ... 16.00
	Redox potential: -1999 ... 1999 mV
	rH value (with pH/ORP sensor): 0 ... 42.5
Glass electrode input Ref. temperature 25 °C (77 °F)	Input resistance > $1 \times 10^{12} \Omega$ Input current < $1 \times 10^{-12} \text{ A}$ Impedance measuring range: 0.5 ... 1000 M Ω ($\pm 20\%$)
Glass electrode input Ref. temperature 25 °C (77 °F)	Input resistance > $1 \times 10^{10} \Omega$ Input current < $1 \times 10^{-10} \text{ A}$ Impedance measuring range: 0.5 ... 200 k Ω ($\pm 20\%$)
Measurement uncertainty ^{2) 3)}	pH value < 0.02, TC: 0.002 pH/K mV value < 1 mV, TC: 0.1 mV/K
Temperature input via module	
Temperature detector	Pt100/Pt1000/NTC 30 k Ω /NTC 8.55 k Ω /Balco 3 k Ω 2-wire connection, adjustable
Measuring ranges	Pt100/Pt1000: -20.0 ... 200.0 °C (-4 ... 392 °F)
	NTC 30 k Ω : -20.0 ... 150.0 °C (-4 ... 302 °F)
	NTC 8.55 k Ω (Mitsubishi): -10.0 ... 130.0 °C (14 ... 266 °F)
	Balco 3 k Ω : -20.0 ... 130.0 °C (-4 ... 266 °F)
Adjustment range	10 K
Resolution	0.1 °C / 0.1 °F
Measurement uncertainty ^{2) 3)}	< 0.5 K (Pt100: < 1 K; NTC for > 100 °C (212 °F): < 1 K)
Temperature compensation Ref. temperature 25 °C (77 °F)	Off Linear characteristic 00.00 ... 19.99%/K Ultrapure water Table: 0 ... 95 °C can be entered in 5-K increments

¹⁾ ISM with TAN option FW-E053

²⁾ At rated operating conditions

³⁾ ± 1 count, plus sensor error

pH calibration and adjustment

Calibration procedure	Calibration with Calimatic automatic buffer recognition
	Manual calibration with entry of individual buffer values
	Product calibration
	Data entry of pre-measured sensors
	ISFET zero point (for ISFET sensor)
	Temperature probe adjustment
	Determination of nominal zero point
Max. calibration range	Asymmetry potential (zero point): ± 60 mV Slope: 80 ... 103% (47.5 ... 61 mV/pH)
Zero adjustment	± 750 mV for Memosens ISFET

Buffer sets

Knick CaliMat	2.00/4.00/7.00/9.00/12.00
Mettler-Toledo	2.00/4.01/7.00/9.21
Merck/Riedel	2.00/4.00/7.00/9.00/12.00
DIN 19267	1.09/4.65/6.79/9.23/12.75
NIST Standard	1.679/4.005/6.865/9.180
NIST Technical	1.68/4.00/7.00/10.01/12.46
Hamilton	2.00/4.01/7.00/10.01/12.00
Kraft	2.00/4.00/7.00/9.00/11.00
Hamilton A	2.00/4.01/7.00/9.00/11.00
Hamilton B	2.00/4.01/6.00/9.00/11.00
HACH	4.01/7.00/10.01
Ciba (94)	2.06/4.00/7.00/10.00
WTW tech. buffer	2.00/4.01/7.00/10.00
Reagecon	2.00/4.00/7.00/9.00/12.00
Specifiable buffer set	TAN option FW-E002

ORP calibration and adjustment

Calibration procedure	ORP data entry
	ORP adjustment
	ORP check
	Temperature probe adjustment
Max. calibration range	-700 ... 700 Δ mV

Adaptive calibration timer

Interval	0000 ... 9999 h
----------	-----------------

15.7.2 Conductivity (Contacting)

Memosens	
Connection	Terminals 1 ... 5 or via module MK-MS095N
Measurement uncertainty	Dependent on sensor
Analog 2-electrode/4-electrode sensors	
Connection	Via module MK-COND025N
Measuring ranges (Conductance limited to 3500 mS)	2-electrode sensors: 0.2 $\mu\text{S} \times \text{c} \dots 200 \text{ mS} \times \text{c}$ 4-electrode sensors: 0.2 $\mu\text{S} \times \text{c} \dots 1000 \text{ mS} \times \text{c}$
Measurement uncertainty ^{1) 2)}	< 1% of measured value + 0.4 $\mu\text{S} \times \text{c}$
Temperature input via module	
Temperature detector	Pt100/Pt1000/Ni100/NTC 30 k Ω /NTC 8.55 k Ω (Betatherm) 3-wire connection, adjustable
Measuring ranges	Pt100/Pt1000: -50.0 ... 250.0 °C (-58 ... 482 °F) Ni100: -50.0 ... 180.0 °C (-58 ... 356 °F) NTC 30 k Ω : -20.0 ... 150.0 °C (-4 ... 302 °F) NTC 8.55 k Ω : -10.0 ... 130.0 °C (14 ... 266 °F)
Resolution	0.1 °C (0.1 °F)
Measurement uncertainty ^{1) 2)}	< 0.5 K (Pt100: < 1 K; NTC for > 100 °C (212 °F): < 1 K)
Display ranges	
Conductivity	0.000 ... 9.999 $\mu\text{S}/\text{cm}$ 00.00 ... 99.99 $\mu\text{S}/\text{cm}$ 000.0 ... 999.9 $\mu\text{S}/\text{cm}$ 0.000 ... 9.999 mS/cm 00.00 ... 99.99 mS/cm 000.0 ... 999.9 mS/cm 0.000 ... 9.999 S/m 00.00 ... 99.99 S/m
Resistivity	00.00 ... 99.99 M Ω cm
Concentration	0.00 ... 99.99%
Salinity	0.0 ... 45.0‰ (0 ... 35 °C / 32 ... 95 °F)
TDS	0 ... 5000 mg/l (10 ... 40 °C / 50 ... 104 °F)
Settling time (T90)	Approx. 1 s
Water monitoring	
USP function	Water monitoring in the pharmaceutical industry (USP<645>) with additional specifiable limit value (%)
Output	Via relay contact
Calibration and adjustment	
Calibration functions	Automatic with standard calibration solution Calibration by entering cell constant Product calibration Temperature probe adjustment
Permissible cell constant	00.0050 ... 19.9999 cm^{-1}

¹⁾ At rated operating conditions

²⁾ ± 1 count, plus sensor error

15.7.3 Conductivity (Inductive)

Memosens or SE670/SE680K	
Connection	Terminals 1 ... 5 or via module MK-MS095N
Measurement uncertainty	Dependent on sensor
Analog toroidal conductivity sensors SE655/656/660	
Connection	Via module MK-CONDI035N
Measurement uncertainty ^{1) 2)}	< 1% of measured value + 0.005 mS/cm
Temperature input via module	
Temperature detector	Pt100/Pt1000/NTC 30 kΩ 3-wire connection, adjustable
Measuring ranges	Pt100/Pt1000: -50.0 ... 250.0 °C (-58 ... 482 °F) NTC 30 kΩ: -20.0 ... 150.0 °C (-4 ... 302 °F)
Resolution	0.1 °C / 0.1 °F
Measurement uncertainty ^{1) 2)}	0.5 K (Pt100: < 1 K; NTC for > 100 °C (212 °F): < 1 K)
Display ranges	
Conductivity	000.0 ... 999.9 μS/cm (not for SE660/670) 0.000 ... 9.999 mS/cm (not for SE660/670) 00.00 ... 99.99 mS/cm 000.0 ... 999.9 mS/cm 0000 ... 1999 mS/cm 0.000 ... 9.999 S/m 00.00 ... 99.99 S/m
Concentration	0.00 ... 9.99% / 10.0 ... 100.0%
Salinity	0.0 ... 45.0‰ (0 ... 35 °C / 32 ... 95 °F)
TDS	0 ... 5000 mg/l (10 ... 40 °C / 50 ... 104 °F)
Settling time (T90)	Approx. 1 s
Water monitoring	
USP function	Water monitoring in the pharmaceutical industry (USP<645>) with additional specifiable limit value (%)
Output	Via relay contact
Calibration and adjustment	
Calibration functions	Automatic with standard calibration solution Calibration by entering cell factor constant Product calibration Installation factor Zero correction Temperature probe adjustment
Permissible cell factor	00.100 ... 19.999 cm ⁻¹
Permissible transfer ratio	010.0 ... 199.9
Permissible zero offset	± 0.5 mS
Permissible installation factor	0.100 ... 5.000

¹⁾ At rated operating conditions

²⁾ ± 1 count, plus sensor error

15.7.4 Conductivity (Dual)**2× Memosens**

Connection	Terminals 1 ... 5 and module MK-MS095N
------------	--

Measurement uncertainty	Dependent on sensor
-------------------------	---------------------

1× Memosens, 1× analog 2-electrode/4-electrode sensor

Connection	Memosens: Terminals 1 ... 5 Analog sensor: Module MK-COND025N → <i>Conductivity (Contacting)</i> , p. 211
------------	---

Measurement uncertainty	Dependent on sensor
-------------------------	---------------------

2× analog 2-electrode sensor

Connection	Via module MK-CC065N
------------	----------------------

Measuring range	0 ... 30000 $\mu\text{S} \times c$
-----------------	------------------------------------

Measurement uncertainty ^{1) 2)}	< 1% of measured value + 0.4 $\mu\text{S} \times c$
--	---

Connection length	Max. 3 m
-------------------	----------

Temperature input via module

Temperature detector	Pt1000, 2-wire connection, adjustable
----------------------	---------------------------------------

Measuring range	-50.0 ... 200.0 °C (-58 ... 392 °F)
-----------------	-------------------------------------

Resolution	0.1 °C / 0.1 °F
------------	-----------------

Measurement uncertainty ^{1) 2)}	< 0.5 K (< 1 K for > 100 °C / 212 °F)
--	---------------------------------------

Display ranges

Conductivity	0.000 ... 9.999 $\mu\text{S}/\text{cm}$
--------------	---

00.00 ... 99.99 $\mu\text{S}/\text{cm}$

000.0 ... 999.9 $\mu\text{S}/\text{cm}$

0000 ... 9999 $\mu\text{S}/\text{cm}$

Resistivity	00.00 ... 99.99 $\text{M}\Omega \text{ cm}$
-------------	---

Settling time (T90)	Approx. 1 s
---------------------	-------------

Calibration and adjustment

Calibration functions	Automatic with standard calibration solution
-----------------------	--

Calibration by entering cell constant

Product calibration

Temperature probe adjustment

Permissible cell constant	00.0050 ... 19.9999 cm^{-1}
---------------------------	--------------------------------------

¹⁾ At rated operating conditions

²⁾ ± 1 count, plus sensor error

15.7.5 Temperature Compensation (Conductivity)

Off	Without
Linear	Linear characteristic 00.00 ... 19.99%/K Ref. temperature adjustable Ref. temperature 25 °C (77 °F):
NLF	Natural waters in accordance with EN 27888
NaCl	NaCl from 0 (ultrapure water) to 26 wt% (0 ... 120 °C / 32 ... 248 °F)
HCl	Ultrapure water with traces of HCl (0 ... 120 °C / 32 ... 248 °F)
NH ₃	Ultrapure water with traces of NH ₃ (0 ... 120 °C / 32 ... 248 °F)
NaOH	Ultrapure water with traces of NaOH (0 ... 120 °C / 32 ... 248 °F)

15.7.6 Concentration Determination, Conductivity (TAN Option FW-E009)

NaCl	0 ... 28 wt% (0 ... 100 °C / 32 ... 212 °F)
HCl	0 ... 18 wt% (-20 ... 50 °C / -4 ... 122 °F) 22 ... 39 wt% (-20 ... 50 °C / -4 ... 122 °F)
NaOH	0 ... 24 wt% (0 ... 100 °C / 32 ... 212 °F) The measuring range limits apply for 25 °C (77 °F). 15 ... 50 wt% (0 ... 100 °C / 32 ... 212 °F)
H ₂ SO ₄	0 ... 37 wt% (-17.8 ... 110 °C / -0.04 ... 230 °F) The measuring range limits apply for 27 °C (80.6 °F). 28 ... 88 wt% (-17.8 ... 115.6 °C / -0.04 ... 240.08 °F) 89 ... 99 wt% (-17.8 ... 115.6 °C / -0.04 ... 240.08 °F)
HNO ₃	0 ... 30 wt% (-20 ... 50 °C / -4 ... 122 °F) 35 ... 96 wt% (-20 ... 50 °C / -4 ... 122 °F)
H ₂ SO ₄ ·SO ₃ (Oleum)	12 ... 45 wt% (0 ... 120 °C / 32 ... 248 °F) Concentration table can be entered

15.7.7 Oxygen

Operating modes	Measurement in gases Measurement in liquids	
Memosens		
Connection	Terminals 1 ... 5 or via module MK-MS095N	
Measuring principle	Amperometric, With TAN option FW-E016: Trace measurement	
Display range	Temperature: -20.0 ... 150.0 °C (-4 ... 302 °F)	
Measurement uncertainty	Dependent on sensor	
Optical oxygen sensor SE740		
Connection	Terminals 1 ... 6	
Measuring principle	Optical, With TAN option FW-E016: Trace measurement	
Measuring range	0 ... 300% air saturation	
Detection limit	0.01 Vol%	
Settling time T98	< 30 s (for 25 °C (77 °F), from air to nitrogen)	
Display range	Temperature: -10.0 ... 130.0 °C (14 ... 266 °F) The sensor does not deliver a measured value for oxygen above 80 °C (176 °F).	
Measurement uncertainty	Dependent on sensor	
Analog or ISM¹⁾ sensors		
Connection	Via module MK-OXY046N	
Standard	Sensors	SE706: InPro 6800; Oxyferm, ISM
	Input range	Measuring current -600 ... 2 nA, resolution 10 pA
	Measurement uncertainty ²⁾	< 0.5% of measured value + 0.05 nA + 0.005 nA/K
Trace measurement TAN option FW-E016	Sensors	SE707; InPro 6900; Oxyferm/Oxygold
	Input range I	Measuring current -600 ... 2 nA, resolution 10 pA Automatic range switching
	Measurement uncertainty ²⁾	< 0.5% of measured value + 0.05 nA + 0.005 nA/K
	Input range II	Measuring current -10000 ... 2 nA, resolution 166 pA Automatic range switching
	Measurement uncertainty ²⁾	< 0.5% of measured value + 0.8 nA + 0.08 nA/K
Polarization voltage	-400 ... -1000 mV, default setting -675 mV, Resolution < 5 mV	
Permissible guard current	≤ 20 μA	
Temperature input via module		
Temperature detector	NTC 22 kΩ/NTC 30 kΩ 2-wire connection, adjustable	
Measuring range	-20.0 ... 150.0 °C (-4 ... 302 °F)	
Adjustment range	10K	
Resolution	0.1 °C / 0.1 °F	
Measurement uncertainty ^{2) 3)}	< 0.5 K (< 1 K for > 100 °C / 212 °F)	

¹⁾ ISM with TAN option FW-E053

²⁾ At rated operating conditions

³⁾ ± 1 count, plus sensor error

Measuring ranges

Standard sensor (Memosens, SE740, digital, analog)

Saturation¹⁾ 0.0 ... 600.0%Concentration¹⁾
(dissolved oxygen) 0.00 ... 99.99 mg/l (ppm)

Volume concentration in gas 0.00 ... 99.99 Vol%

Trace sensor "01" (Memosens, SE740, analog)

Saturation¹⁾ 0.000 ... 150.0%Concentration¹⁾
(dissolved oxygen) 0000 ... 9999 µg/l / 10.00 ... 20.00 mg/l
0000 ... 9999 ppb / 10.00 ... 20.00 ppm

Volume concentration in gas 000.0 ... 9999 ppm / 1.000 ... 50.00 Vol%

Trace sensor "001" (analog)

Saturation¹⁾ 0.000 ... 150.0%Concentration¹⁾
(dissolved oxygen) 000.0 ... 9999 µg/l / 10.00 ... 20.00 mg/l
000.0 ... 9999 ppb / 10.00 ... 20.00 ppm

Volume concentration in gas 000.0 ... 9999 ppm / 1.000 ... 50.00 Vol%

Input correctionPressure correction 0000 ... 9999 mbar / 999.9 kPa / 145.0 psi (adjustable)
Manual or external (via current input 0(4) ... 20 mA)

Salinity correction 0.0 ... 45.0 g/kg

Calibration and adjustmentCalibration procedure
Automatic calibration in air-saturated water
Automatic calibration in air
Product calibration saturation (with offset for SE740)
Zero correction
Temperature probe adjustment**Calibration ranges**

Standard sensor

Zero point ± 2 nA

Slope 25 ... 130 nA (for 25 °C/77 °F, 1013 mbar)

Trace sensor "01"

Zero point ± 2 nA

Slope 200 ... 550 nA (for 25 °C/77 °F, 1013 mbar)

Trace sensor "001"

Zero point ± 3 nA

Slope 2000 ... 9000 nA (for 25 °C/77 °F, 1013 mbar)

Calibration timer 0000 ... 9999 h¹⁾ For temperature range -10 ... 80 °C (14 ... 176 °F)

15.8 Diagnostics and Statistics

Diagnostic functions	
Calibration data	Calibration record
Device self-test	Automatic memory test (RAM, FLASH, EEPROM)
Display test	Display of all colors
Keypad test	Key function check
Sensocheck	
Delay time	Approx. 30 s
pH	Automated monitoring of glass and reference electrodes (can be switched off)
Cond	Polarization detection and cable capacity monitoring
Condl	Monitoring of primary and secondary coils and cables for interruption, and primary coil and cables for short circuits
Oxygen	Only for amperometric sensors Monitoring of membrane and electrolyte and sensor wires for short circuit and interruption (can be switched off)
Sensoface	
Function	Delivers information on sensor state (happy, neutral, or sad Smiley), can be switched off. Evaluation criteria → <i>Sensocheck and Sensoface, p. 178</i>
pH	Evaluation of zero point/slope, settling time, calibration interval, Sensocheck, wear
Cond	Evaluation of Sensocheck
Condl	Evaluation of zero point, cell factor, installation factor, Sensocheck
Oxygen	For digital sensors: evaluation of zero point/slope, settling time, calibration interval, Sensocheck, and sensor wear
Sensor monitor	
Function	Display of direct sensor measured values
pH	pH/voltage/temperature
Cond	Resistance/temperature
Condl	Resistance/temperature
Oxygen	Sensor current/temperature
Measurement recorder TAN option FW-E103 → <i>Measurement Recorder (FW-E103), p. 201</i>	
Function	4-channel measured value recorder with marking of events (Failure, Maintenance Required, Function Check, Limit Values)
Storage capacity	100 entries in device memory, 20,000 entries or more in conjunction with Data Card
Recording	Process variables and span freely selectable
Type of recording	Current value
Time base	10 s... 10 h
Logbook	
Function	Recording of functions opened, warning messages and failure messages upon occurrence and elimination with data and time, 100 entries with date and time in device memory, read out via display
TAN option FW-E104	20,000 entries or more in conjunction with Data Card

16 Appendix

16.1 Channel II Wiring Examples

16.1.1 pH Analog Wiring Examples

Example 1, pH Analog

Measurement task:	pH, temperature, glass impedance
Sensors (example):	SE 555X/1-NS8N
Cable (example):	ZU 0318

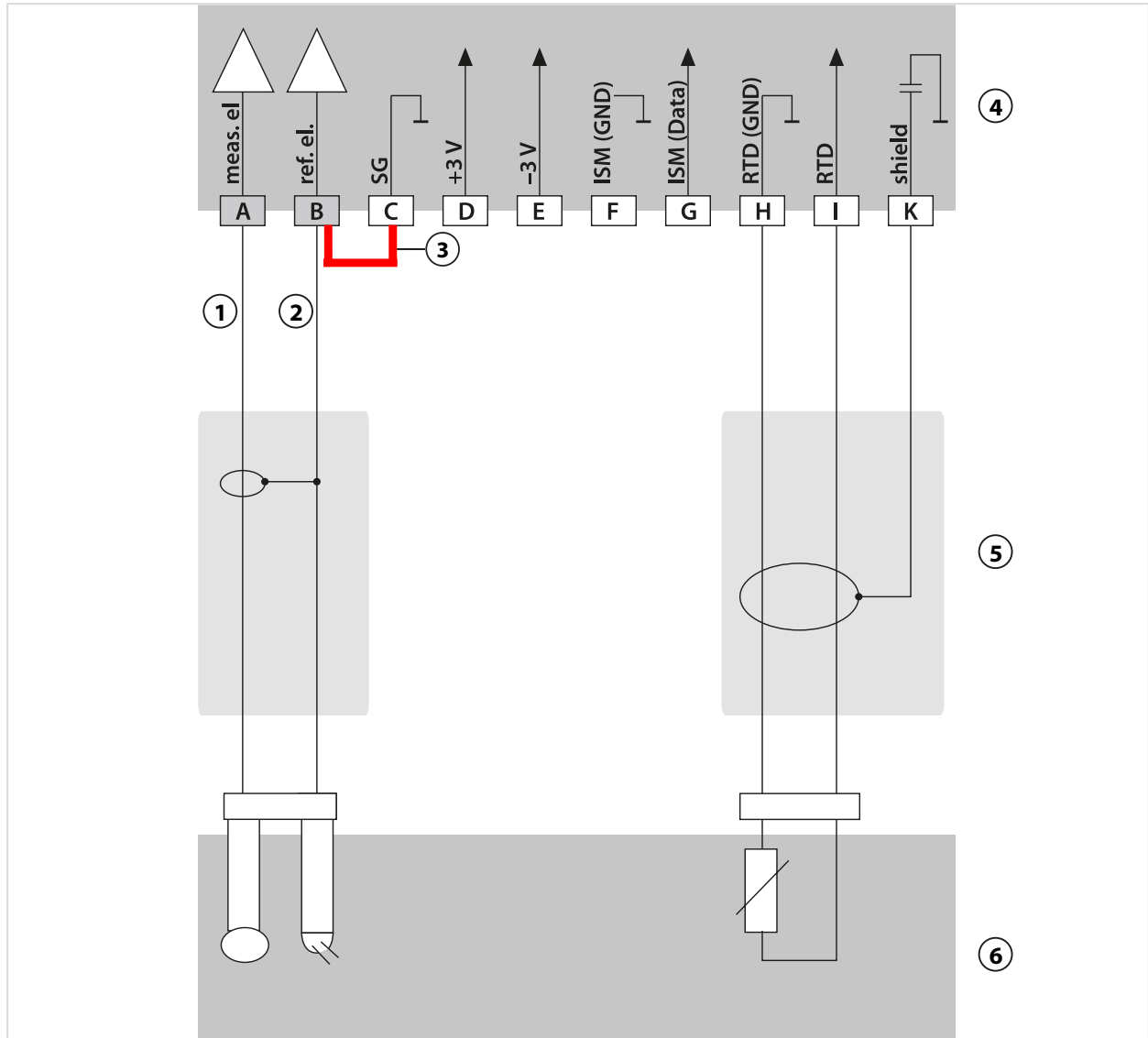

1 Core	4 pH measuring module
2 Shield	5 Cable
3 Jumper!	6 Sensors

Example 2, pH Analog

Measurement task:	pH/ORP, temp., glass impedance, reference impedance
Sensors (example):	SE555X/1-NS8N, equipotential bonding: ZU0073 Temperature: e.g., Pt1000
Cable (example):	2x ZU0318

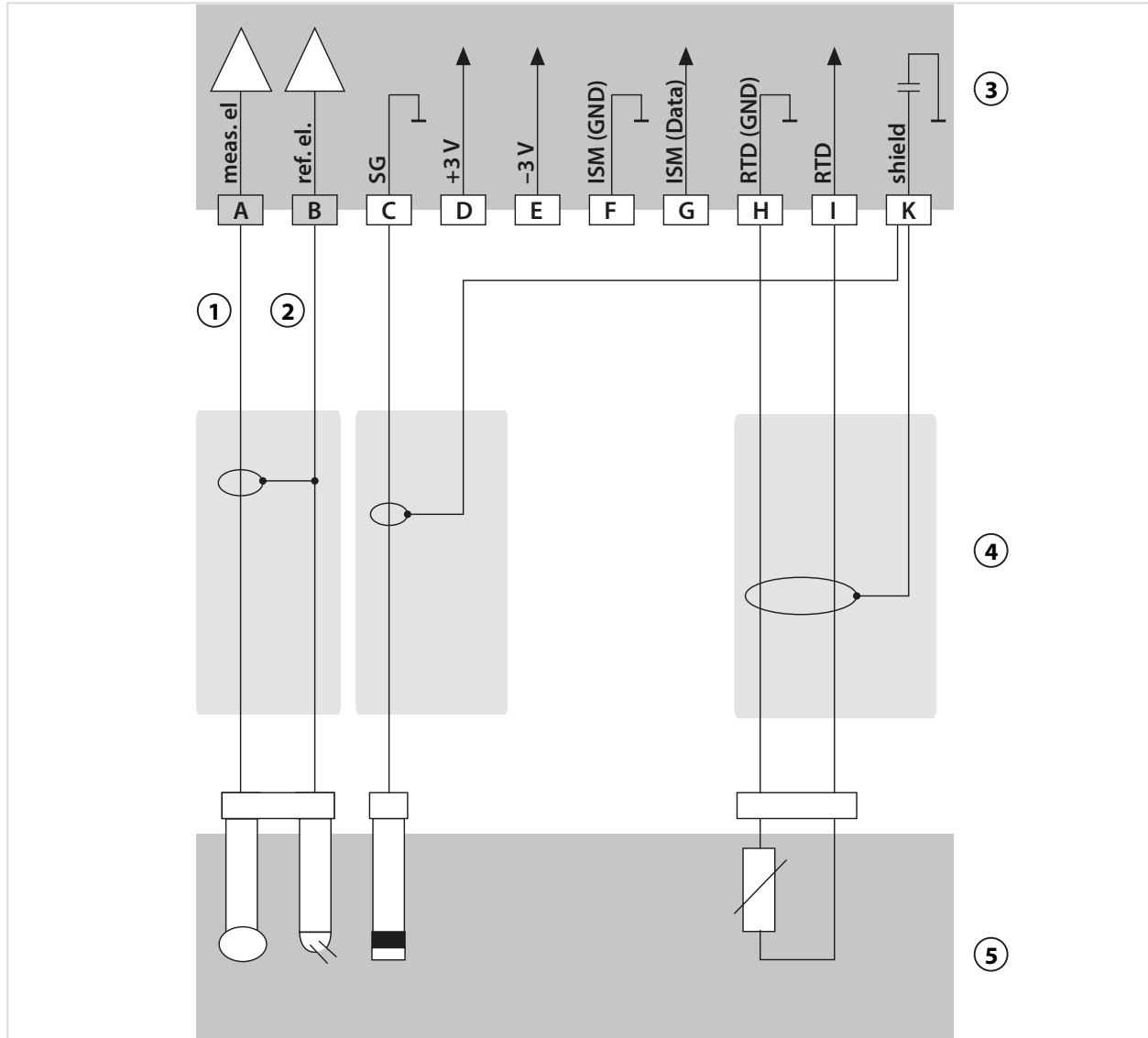

1 Core	4 Cable
2 Shield	5 Sensors
3 pH measuring module	

Example 3, pH Analog

Measurement task:	pH, temp, glass impedance
Sensor:	pH sensor e.g., SE 554X/1-NVPM, cable CA/VP6ST-003A
Temperature detector:	Integrated

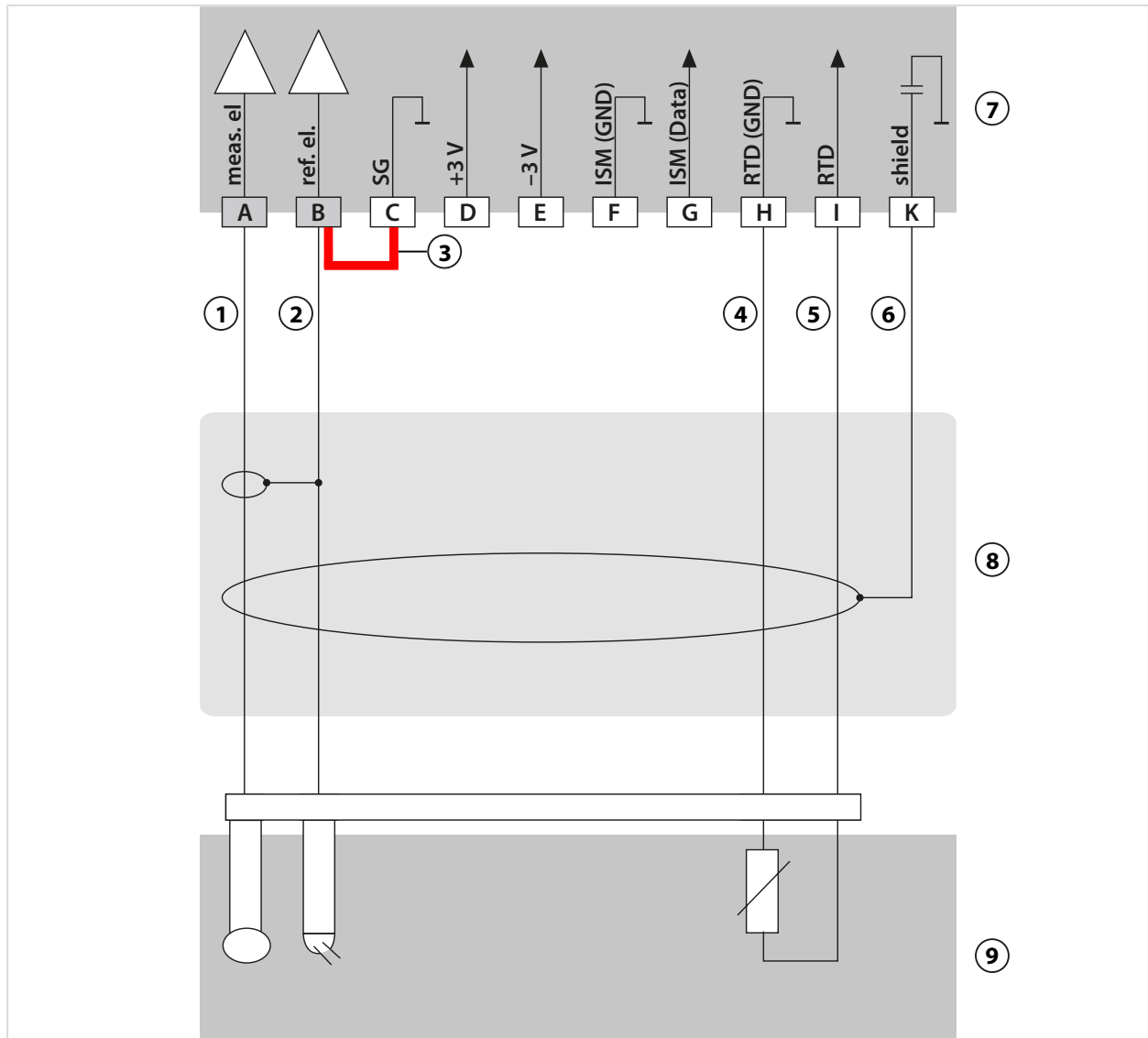

1 Core, clear	6 Shield, yellow/green
2 Shield, red	7 pH measuring module
3 Jumper!	8 VP cable
4 Green	9 Sensor
5 White	

Example 4, pH Analog

Measurement task:	pH/ORP, temp., glass impedance, reference impedance
Sensors (example):	pH sensor, e.g., SE 555X/1-NVPN, cable CA/VP6ST-003A
Temperature detector:	Integrated

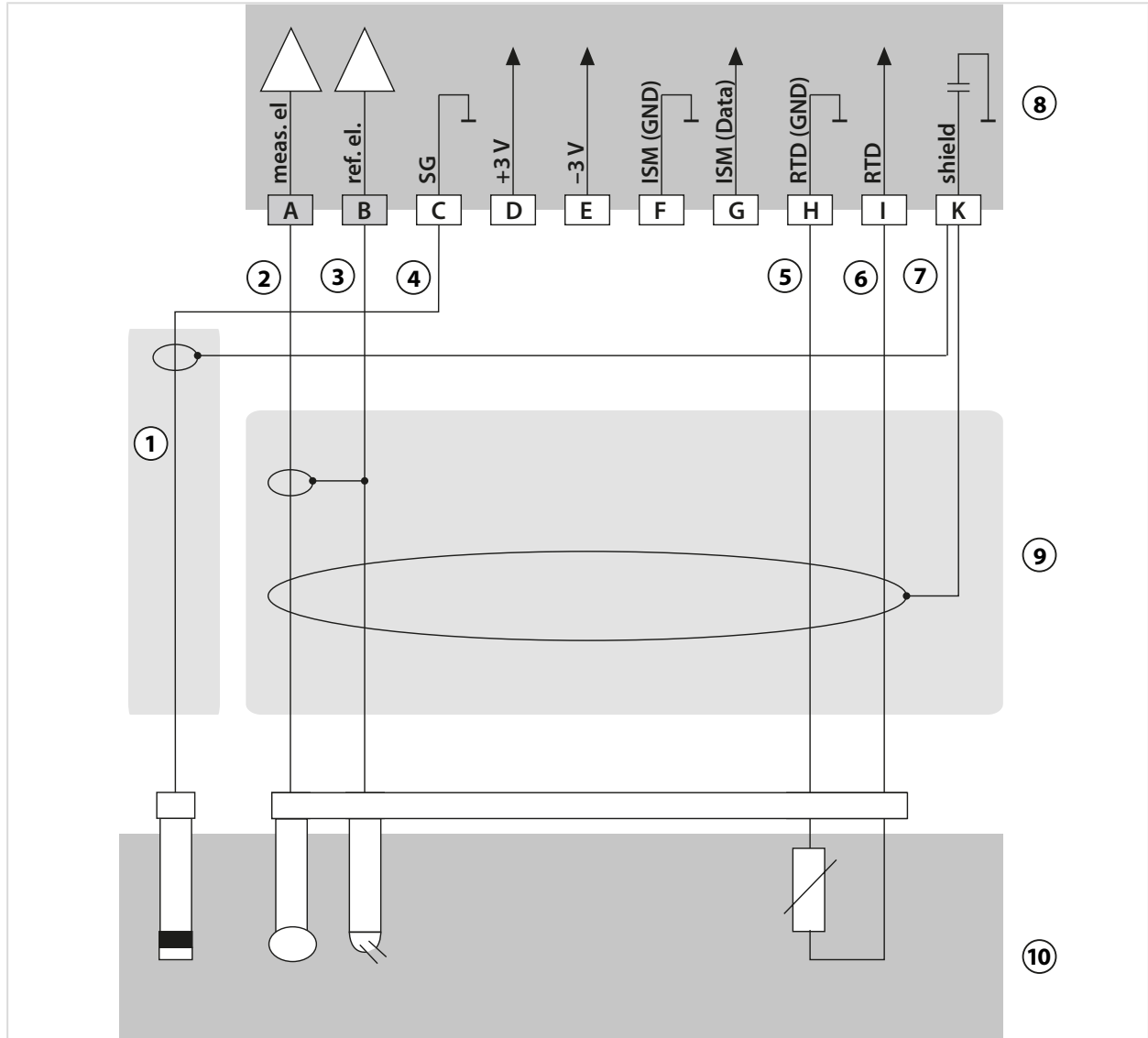

1 Equipotential bonding electrode ZU0073	6 White
2 Core, clear	7 Shield, yellow/green
3 Shield, red	8 pH measuring module
4 Core	9 Cable
5 Green	10 Sensors

Example 5, pH Analog

Measurement task:	pH/ORP, temp., glass impedance, reference impedance
Sensors (example):	PL PETR-120VP (pH/ORP combo sensor, SI Analytics)
Cable (example):	CA/VP6ST-003A

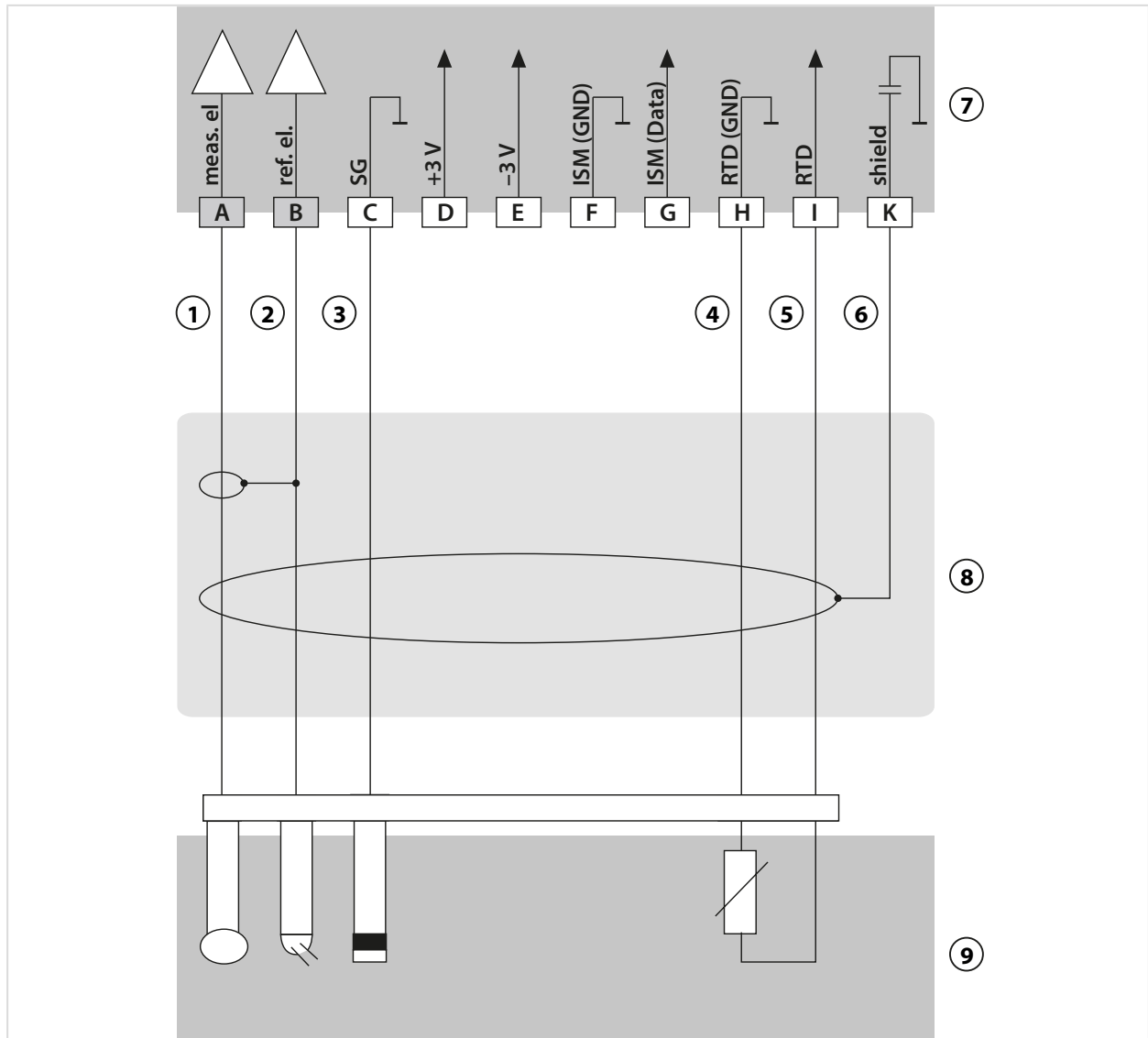

1 Core, transparent	6 Shield, yellow/green
2 Shield, red	7 pH measuring module
3 Blue	8 Cable
4 Green	9 Sensor
5 White	

Example 6, Pfaudler Sensor

Channel II, requires TAN option FW-E017 "Pfaudler sensors"

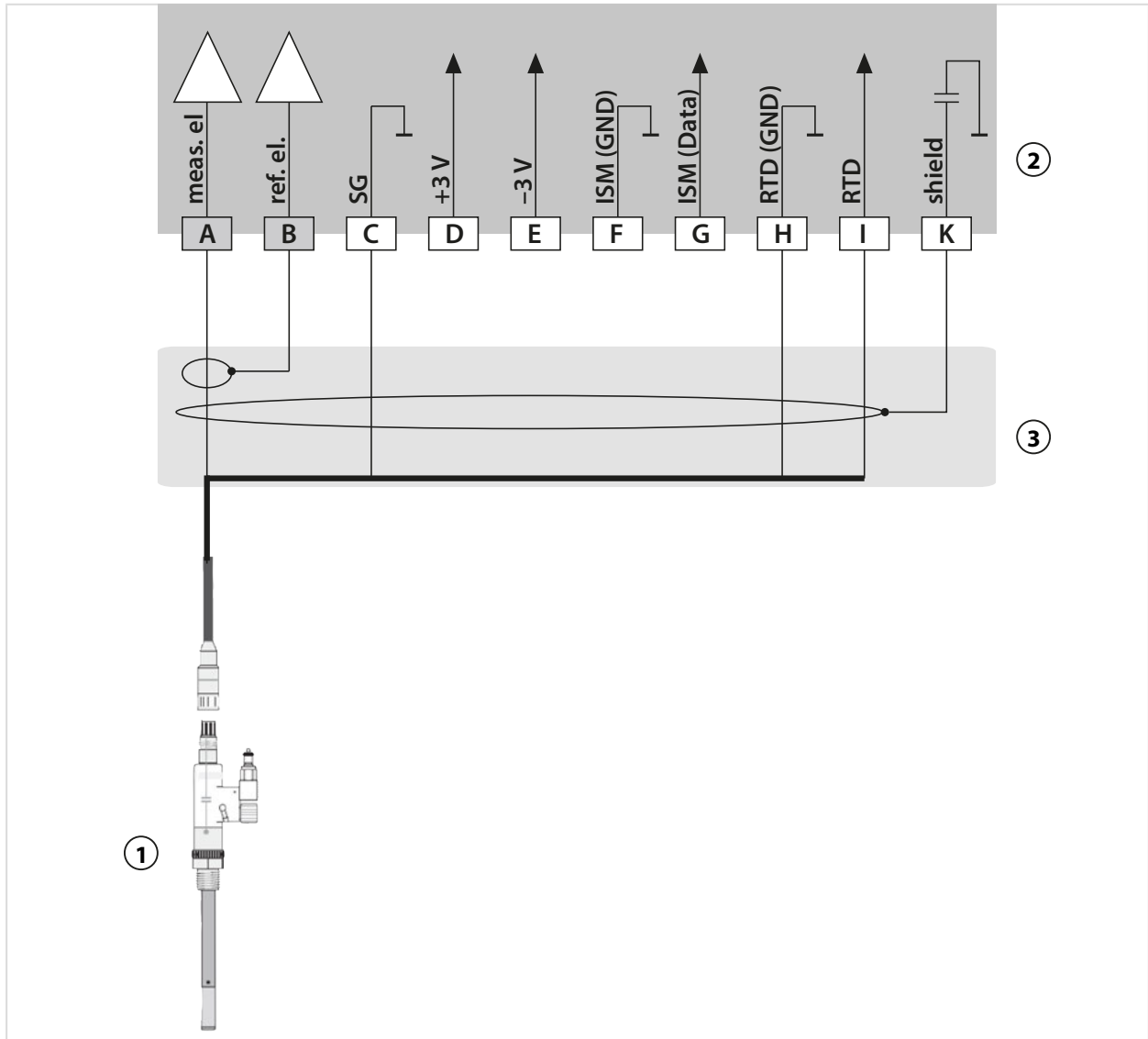

- 1 Pfaudler probe
- 2 pH measuring module
- 3 Cable

Module	pH Reiner with EP ¹⁾ VP connector	Differential, models 18/40 with EP ¹⁾	Models 03/04 with EP ¹⁾	Models 03/04 without EP ¹⁾
A Meas	Coax core	Coax white	Coax white	Coax white
B Ref	Coax shield	Coax brown	Coax brown	Coax brown
C SG	Blue	Blue	Blue	Jumper B/C
...				
H RTD (GND)	Green	Brown	Brown	Brown
I RTD	White	Green, Black	Green, Black	Green, Black
K Shield	Green/Yellow, Gray	Orange, Violet	Orange, Violet	Orange, Violet

¹⁾ Equipotential bonding

16.1.2 ORP Analog Wiring Example

Note: Disable Sensocheck.

Measurement task:	ORP, temp., glass impedance, reference impedance
Sensors (example):	ORP: SE564X/1-NS8N
Cable (example):	ZU0318

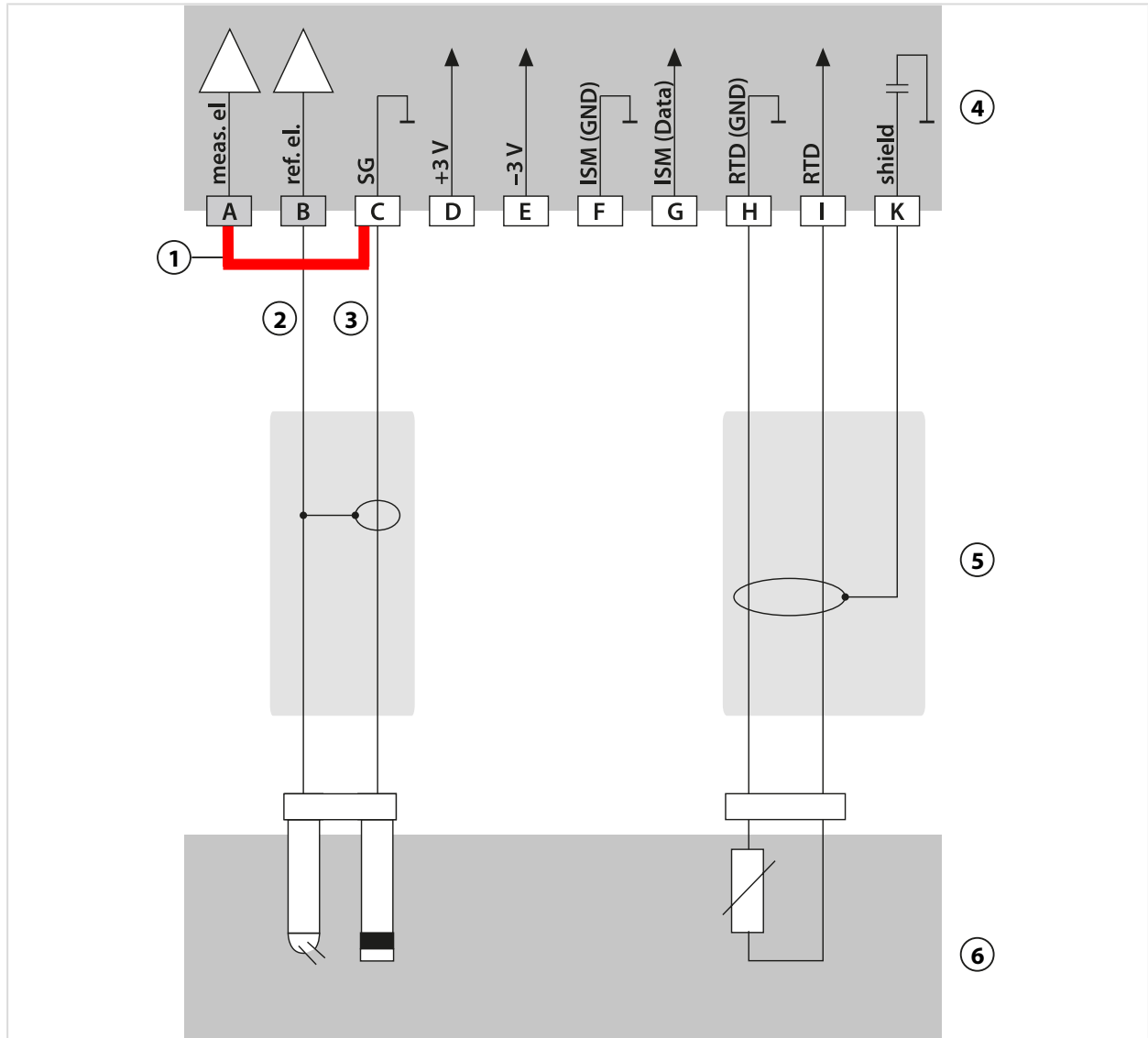

1 Jumper	4 pH measuring module
2 Shield	5 Cable
3 Core	6 Sensors

16.1.3 ISM pH Wiring Example

Channel II, requires TAN option FW-E053 "Digital ISM sensors"

Measurement task:	pH/ORP, temp., glass impedance, reference impedance
Sensors (example):	InPro 4260i (Mettler-Toledo)
Cable (example):	AK9 (Mettler-Toledo)

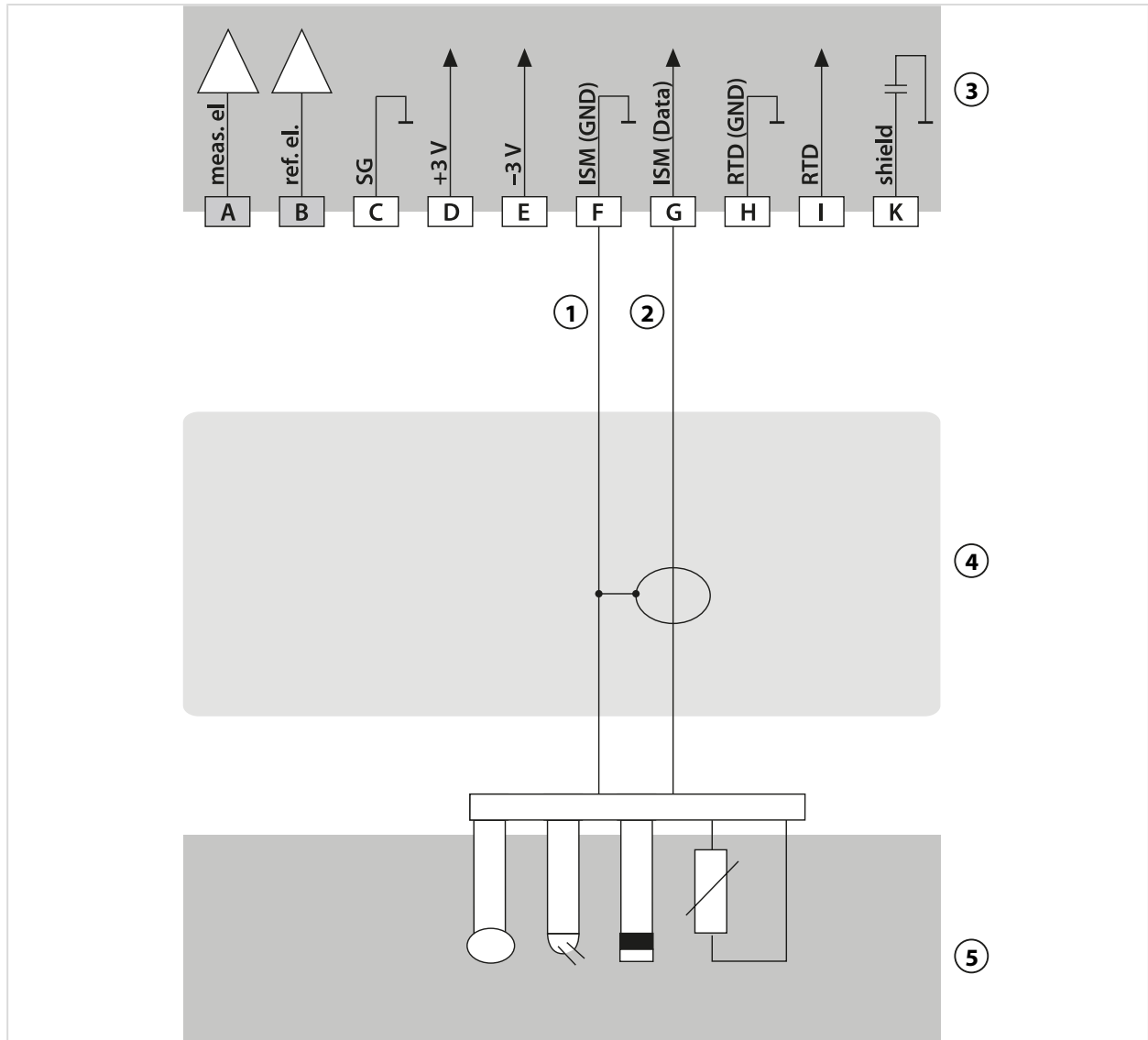

1 Shield	4 Cable
2 Core	5 Sensor
3 pH measuring module	

16.1.4 Contacting Conductivity Wiring Examples

Example 1, Cond

Measurement task: Conductivity, temperature

Sensors (principle): 4 electrodes

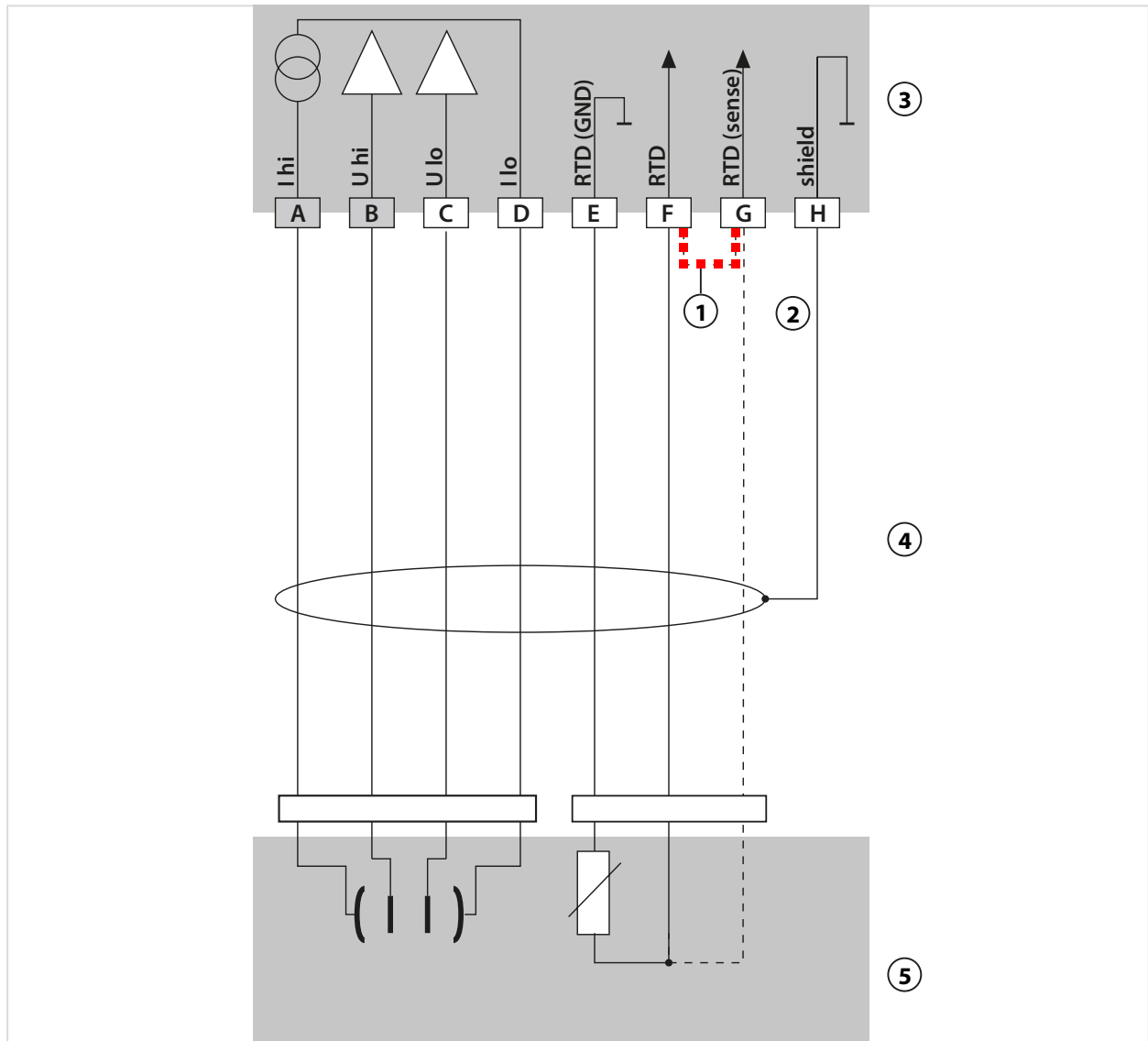

- | | |
|--|-----------|
| 1 Set jumper between F and G if a 2-wire temperature detector is used! | 4 Cable |
| 2 Shield | 5 Sensors |
| 3 COND measuring module | |

Example 2, Cond

Measurement task: Conductivity, temperature

Sensors (principle): 2 electrodes, coaxial

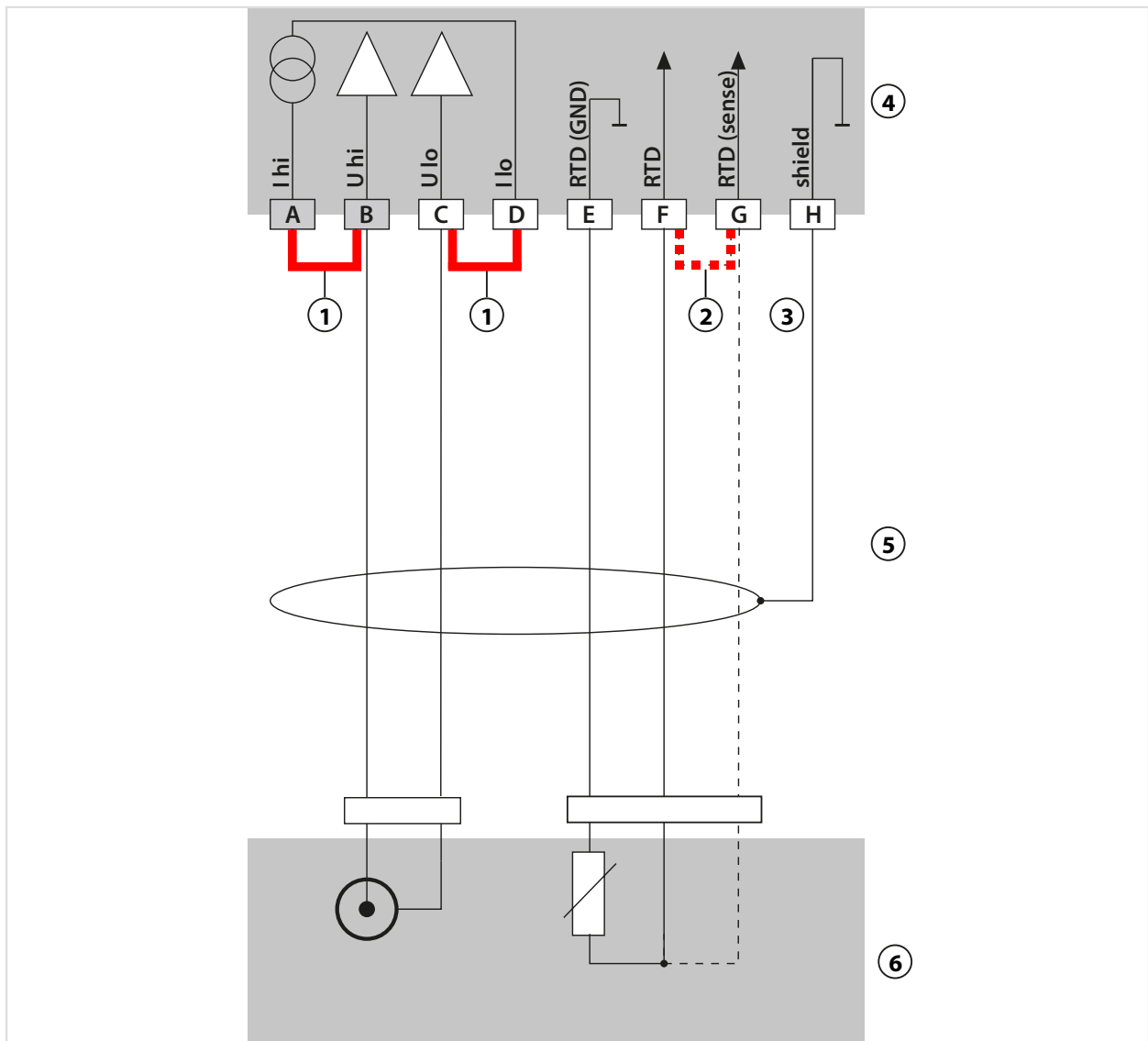

- | | |
|---|-------------------------|
| 1 Jumper! | 4 COND measuring module |
| 2 Set jumper between F and G if only a 2-wire temperature detector is used! | 5 Cable |
| 3 Shield | 6 Sensors |

Example 3, Cond

Measurement task: Conductivity, temperature
 Sensors (example): 2-electrode sensor SE604, cable ZU0645

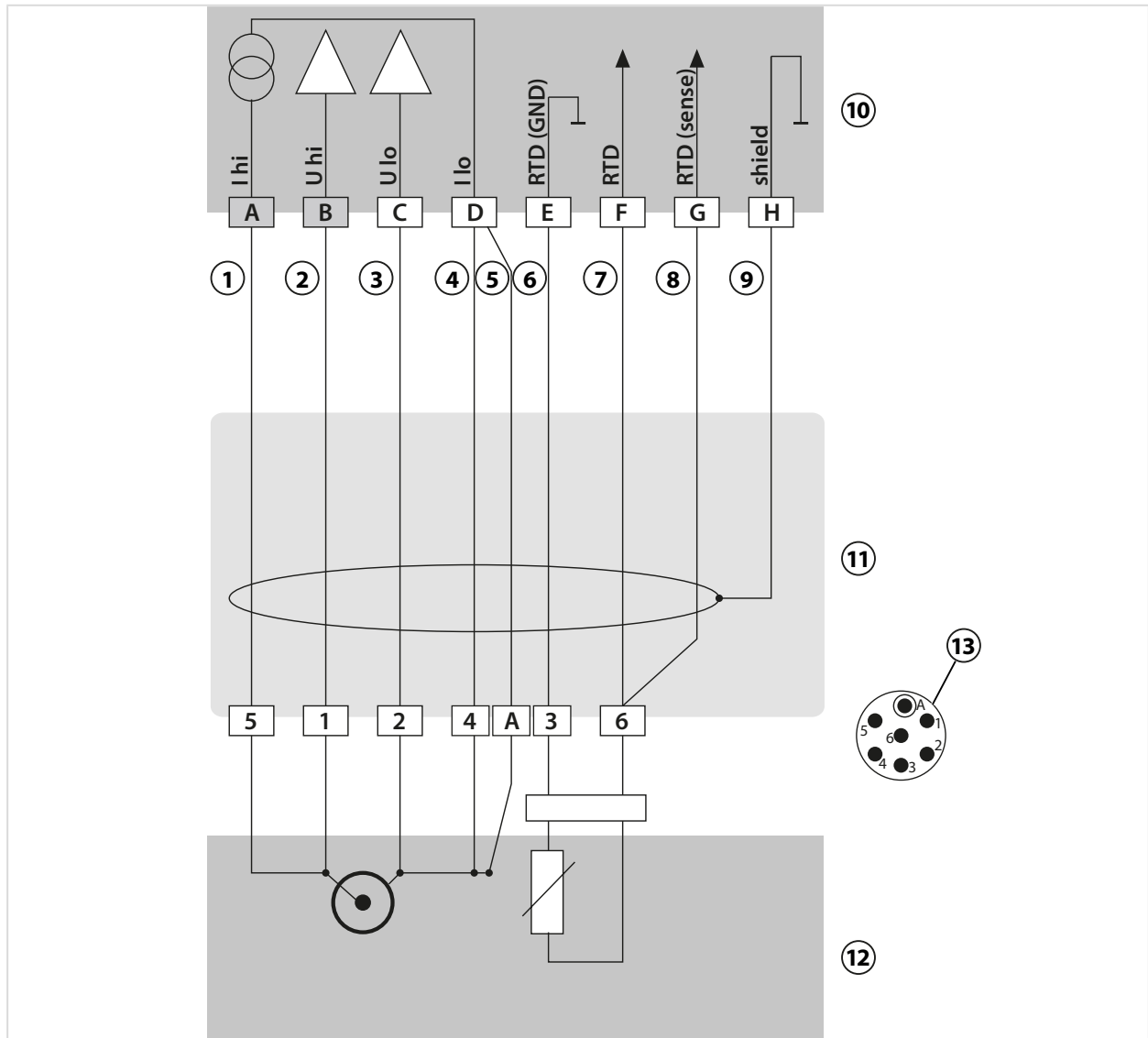

1 White	8 Red
2 Pink	9 Black, shield
3 Brown	10 COND measuring module
4 Gray	11 Cable
5 Blue	12 Sensors
6 Green	13 Sensor head plug
7 Yellow	

Example 4, Cond

Measurement task: Conductivity, temperature
 Sensors (example): 2-electrode sensor SE610

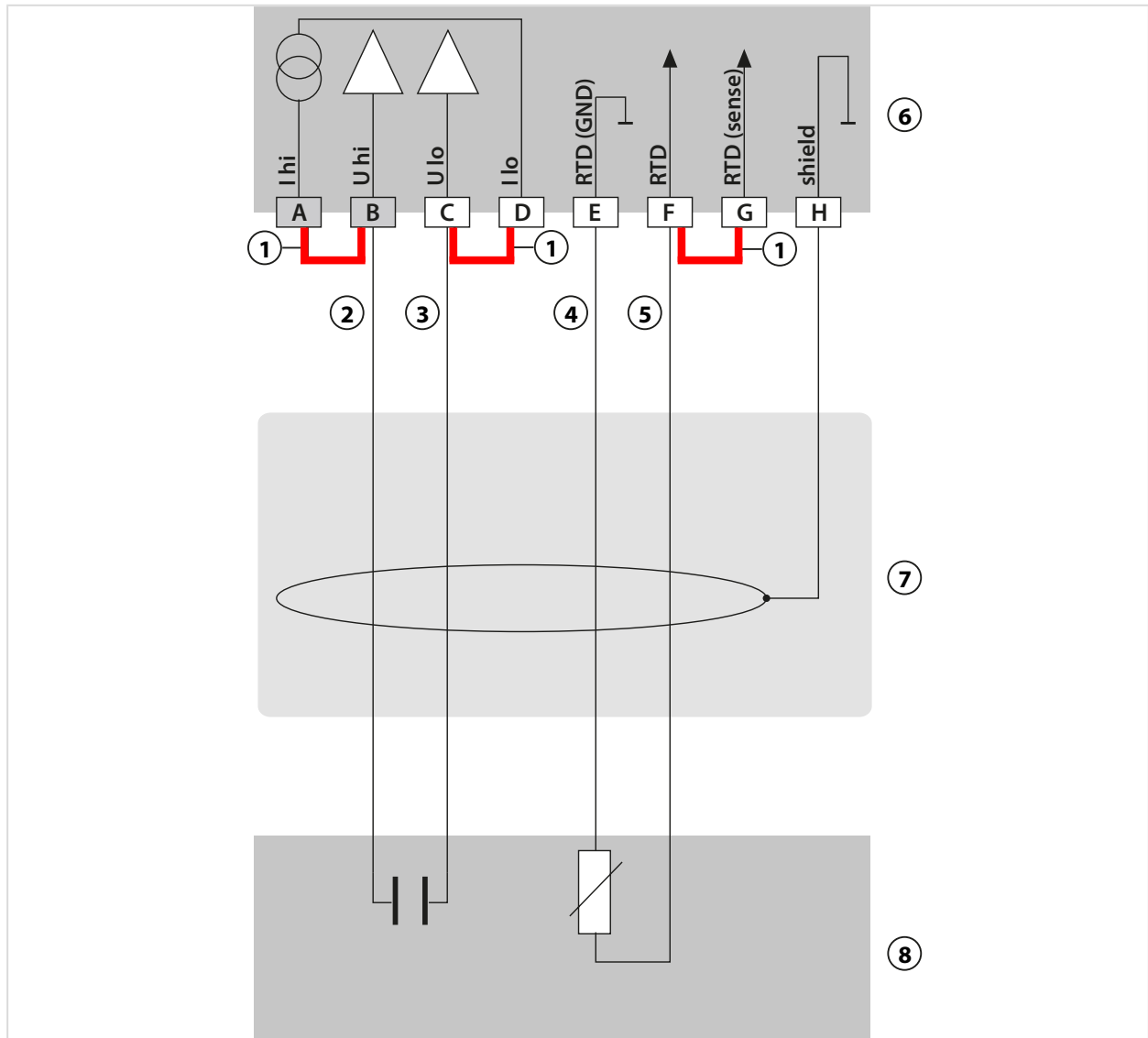

1 Jumper!	5 Yellow
2 Brown	6 COND measuring module
3 White	7 Fixed cable
4 Green	8 Sensors

Example 5, Cond

Measurement task:	Conductivity, temperature
Sensors (example):	2-electrode sensor SE620
VP cable	e.g., CA/VP6ST-003A

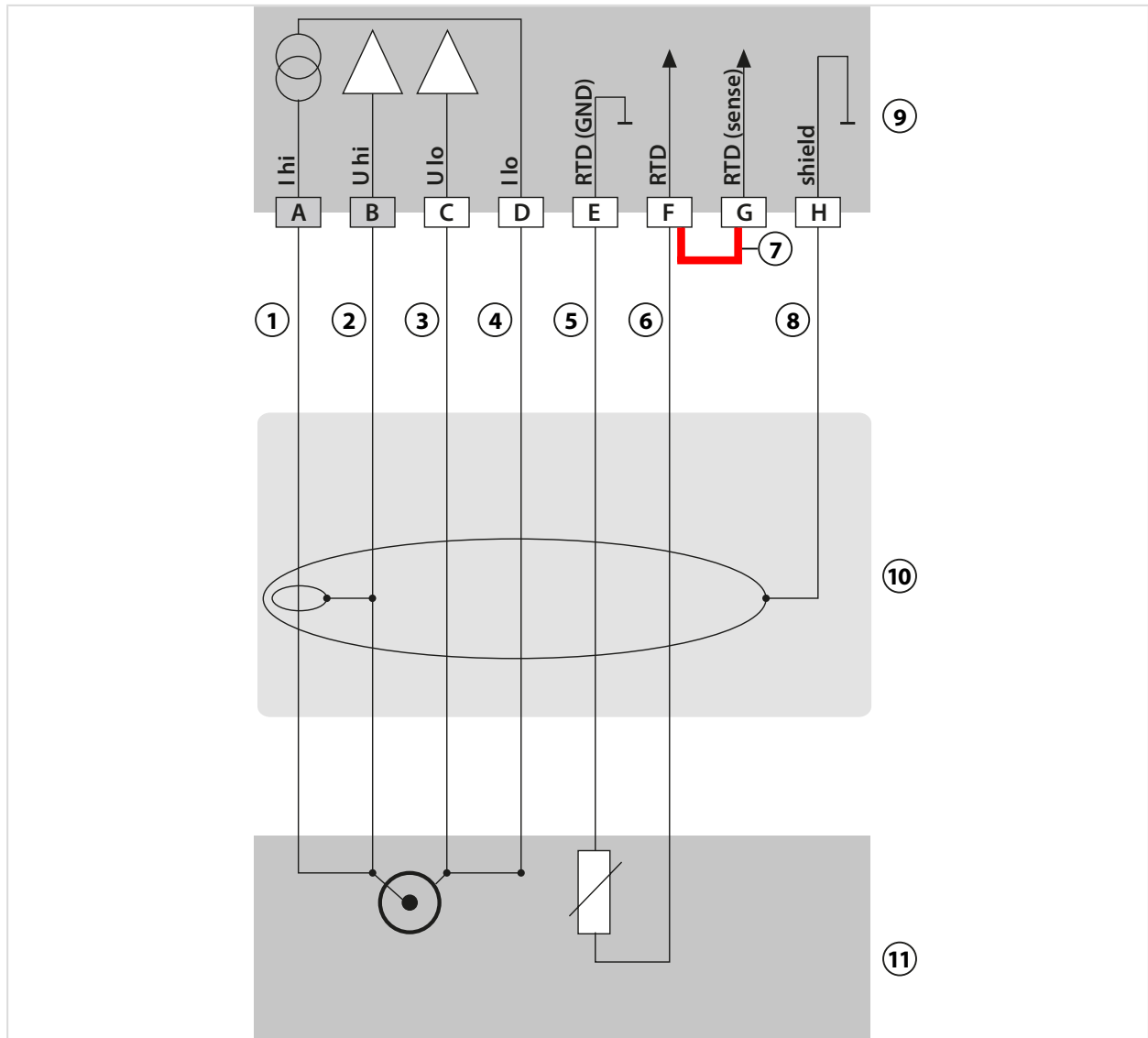

1 Coax core	7 Jumper!
2 Coax shield	8 Shield
3 Gray	9 COND measuring module
4 Blue	10 VP cable
5 Green	11 Sensors
6 White	

Example 6, Cond

Measurement task: Conductivity, temperature
 Sensors (example): 2-electrode sensor SE630

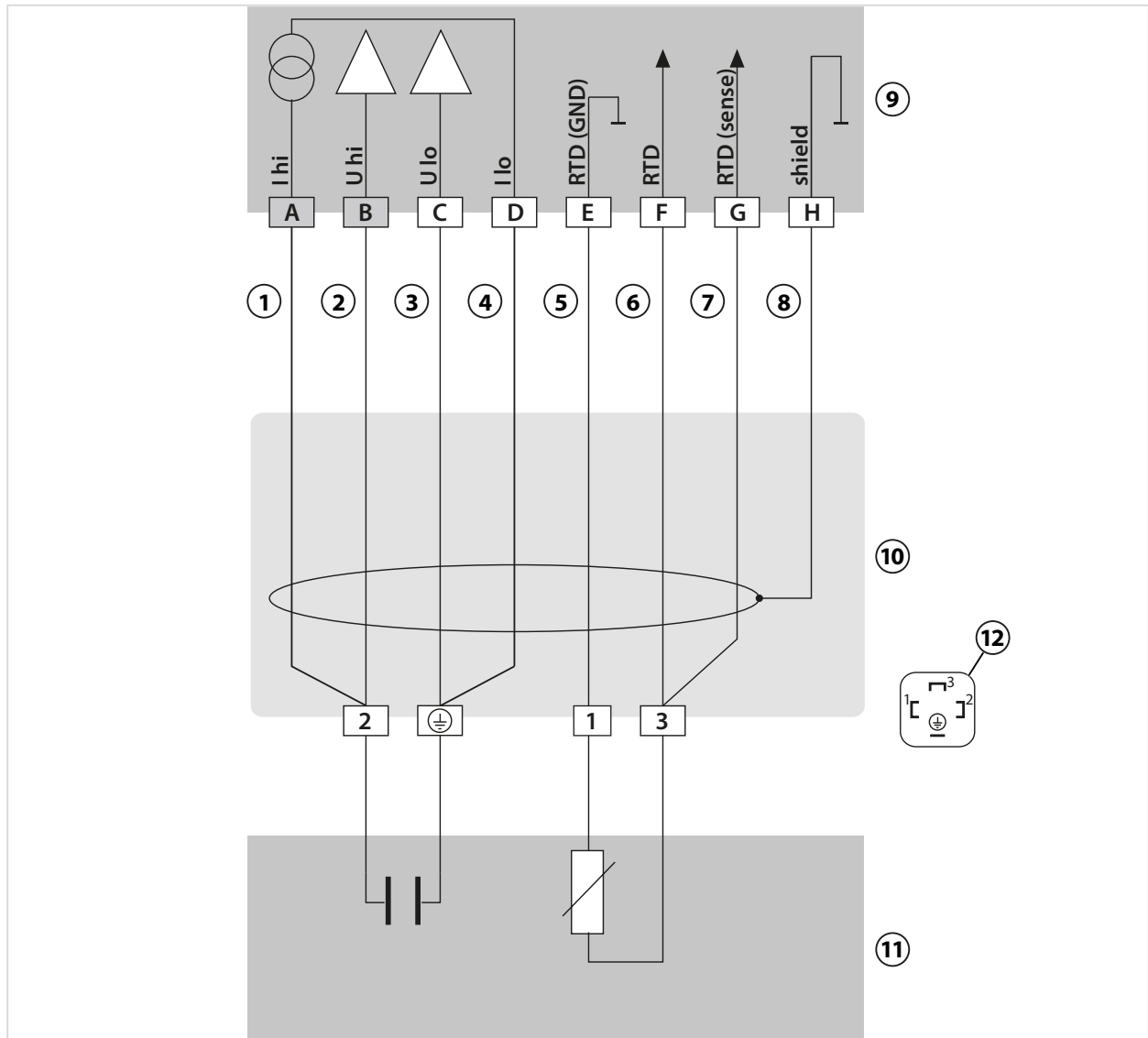

1 Brown	7 Pink
2 Yellow	8 Black, shield
3 Green	9 COND measuring module
4 White	10 Cable
5 Gray	11 Sensors
6 Red	12 Sensor head plug-in connection

Example 7, Cond

Measurement task:	Conductivity, temperature
Sensors (example):	4-electrode stray-field sensor SE600/SE603

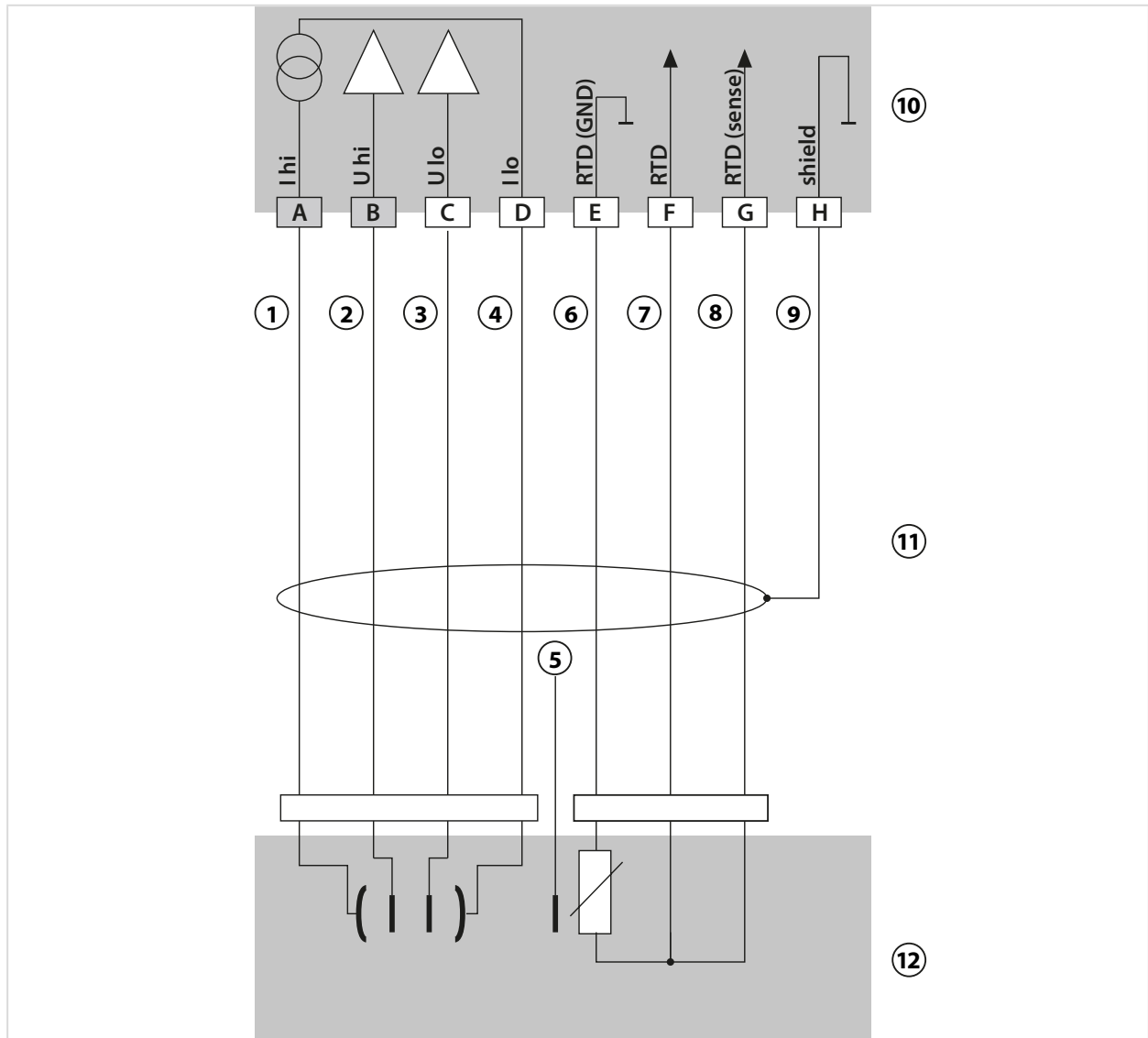

1 Gray	7 Yellow
2 Pink	8 Green
3 Blue	9 Shield yellow/green
4 Red	10 COND measuring module
5 Brown, do not connect	11 Cable
6 White/green	12 Sensors

16.1.5 Inductive Conductivity Wiring Examples

Example 1, Condl

Measurement task: Inductive conductivity/temperature

Sensors: SE655 or SE656

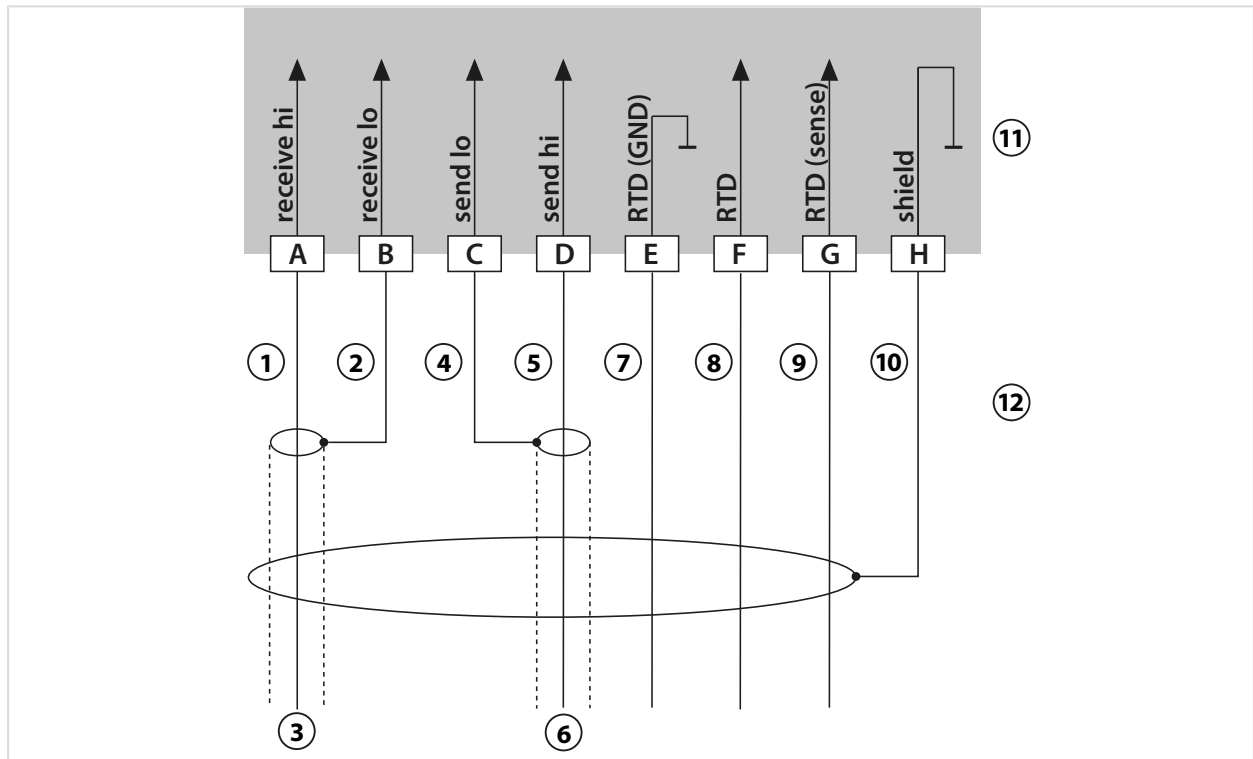

1 Core	7 Green
2 Shield	8 White
3 Coax red	9 Yellow
4 Shield	10 Shield green/yellow
5 Core	11 Condl measuring module
6 Coax white	12 Cable

Example 2, Condl

Measurement task: Conductivity, temperature

Sensor: SE660

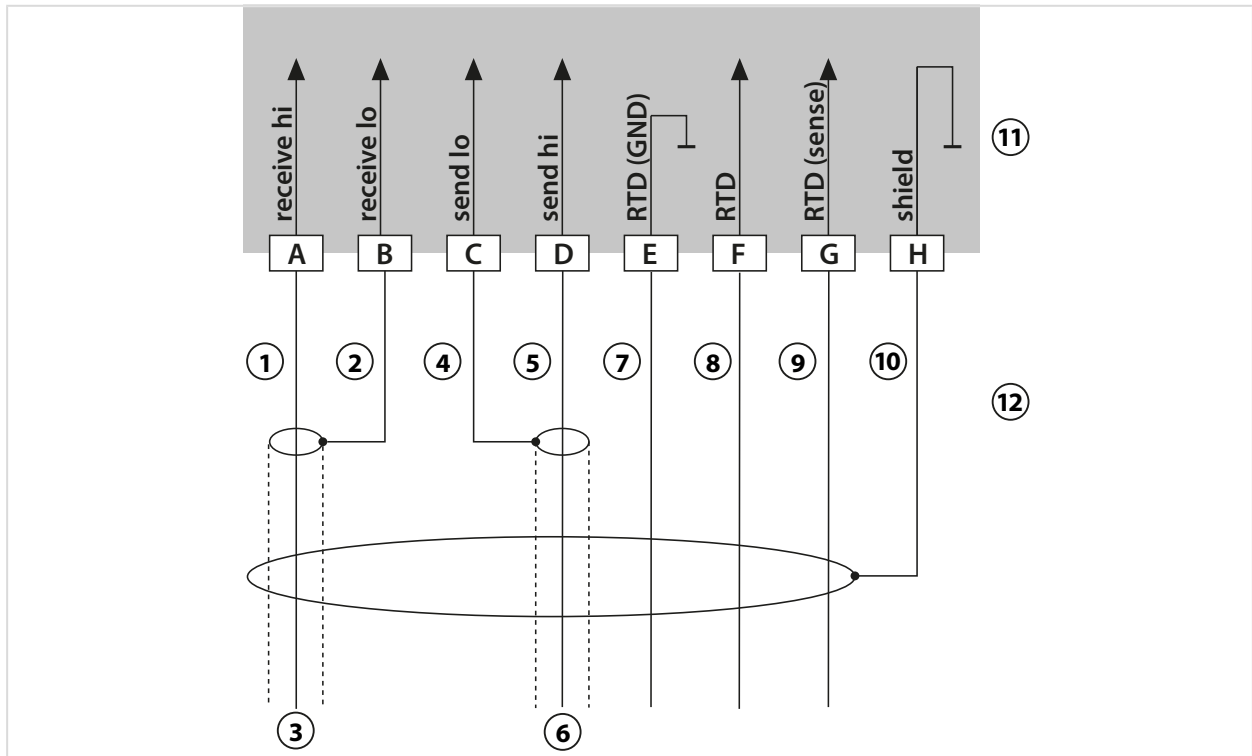

1 Core	7 Green
2 Shield	8 White
3 Coax red	9 Yellow
4 Shield	10 Shield green/yellow
5 Core	11 Condl measuring module
6 Coax black	12 Cable

16.1.6 Dual Conductivity Wiring Examples

Example 1, Dual Conductivity

Measurement task: Dual conductivity, temperature

Sensors A, B: 2x 2-electrode conductivity sensors

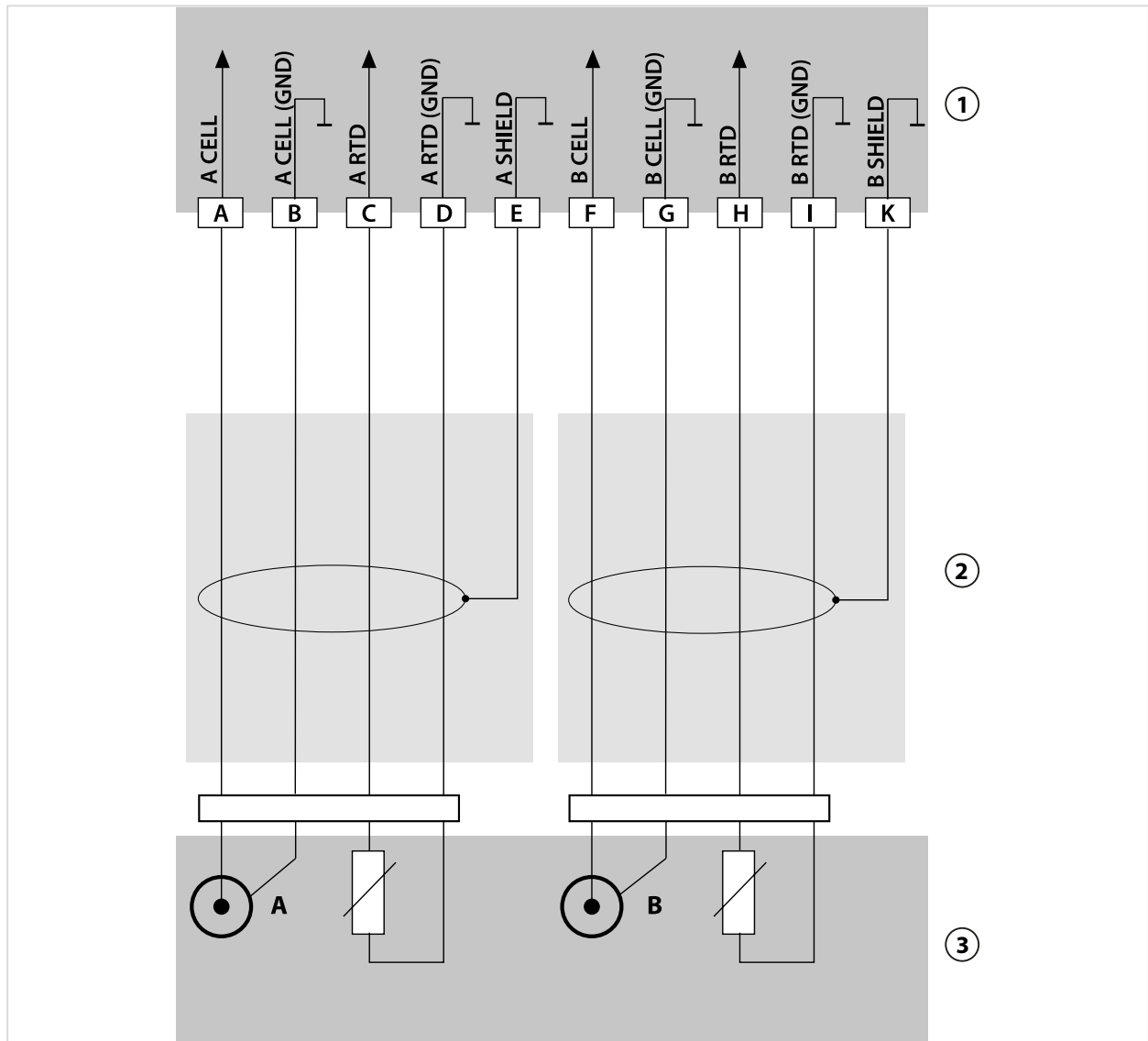

1 Module MK-CC065N

3 Sensors

2 2x cable

Example 2, Dual Conductivity

Measurement task:	Dual conductivity, temperature
Sensors A, B:	2x SE604 2-electrode conductivity sensor

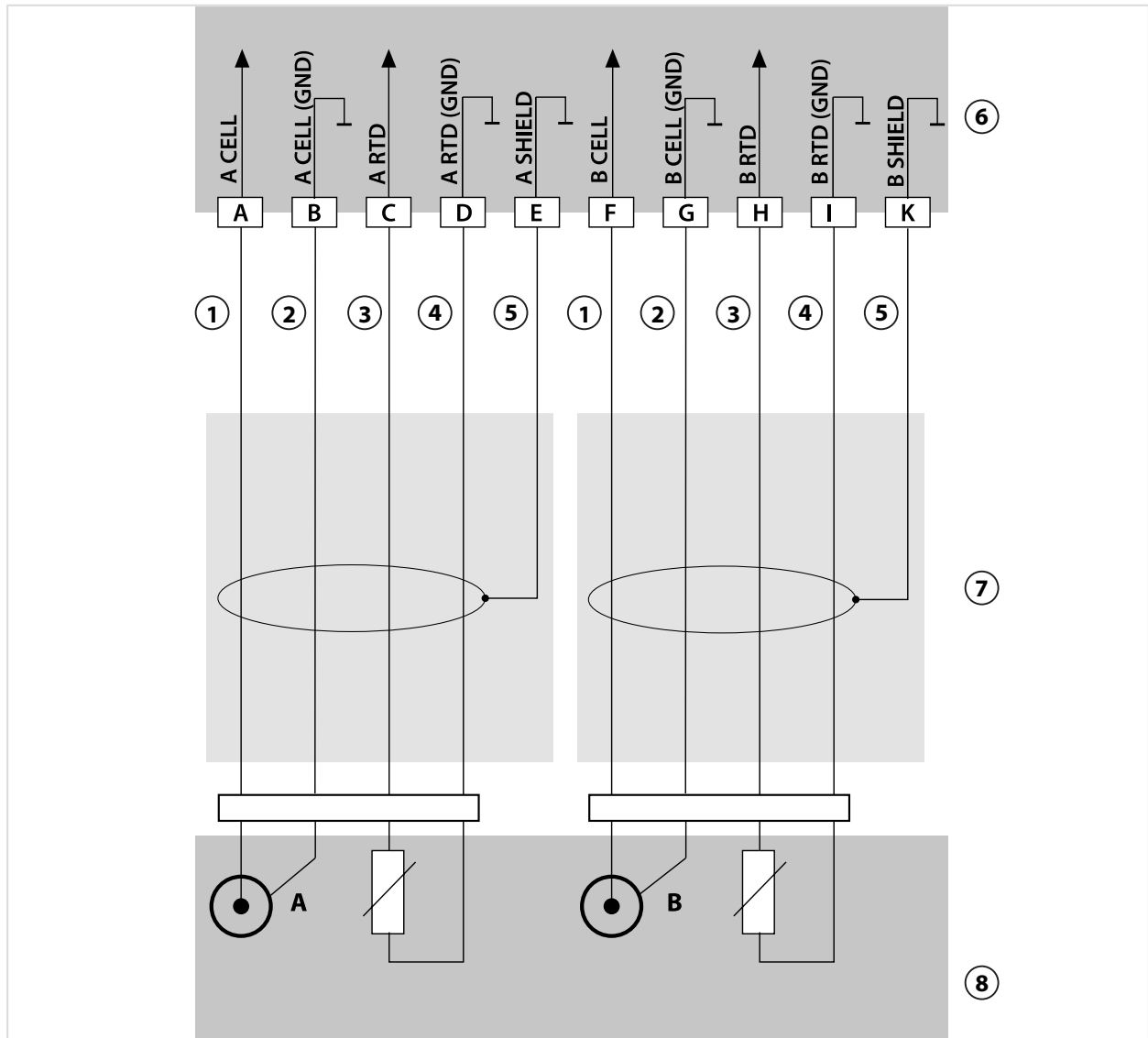

1 White/pink	5 Black
2 Brown/gray	6 Module MK-CC065N
3 Yellow/red	7 2x ZU0645 cable
4 Green	8 Sensors

Example 3, Dual Conductivity

Measurement task:	Dual conductivity, temperature
Sensors A, B:	2x 2 electrode conductivity sensors SE610

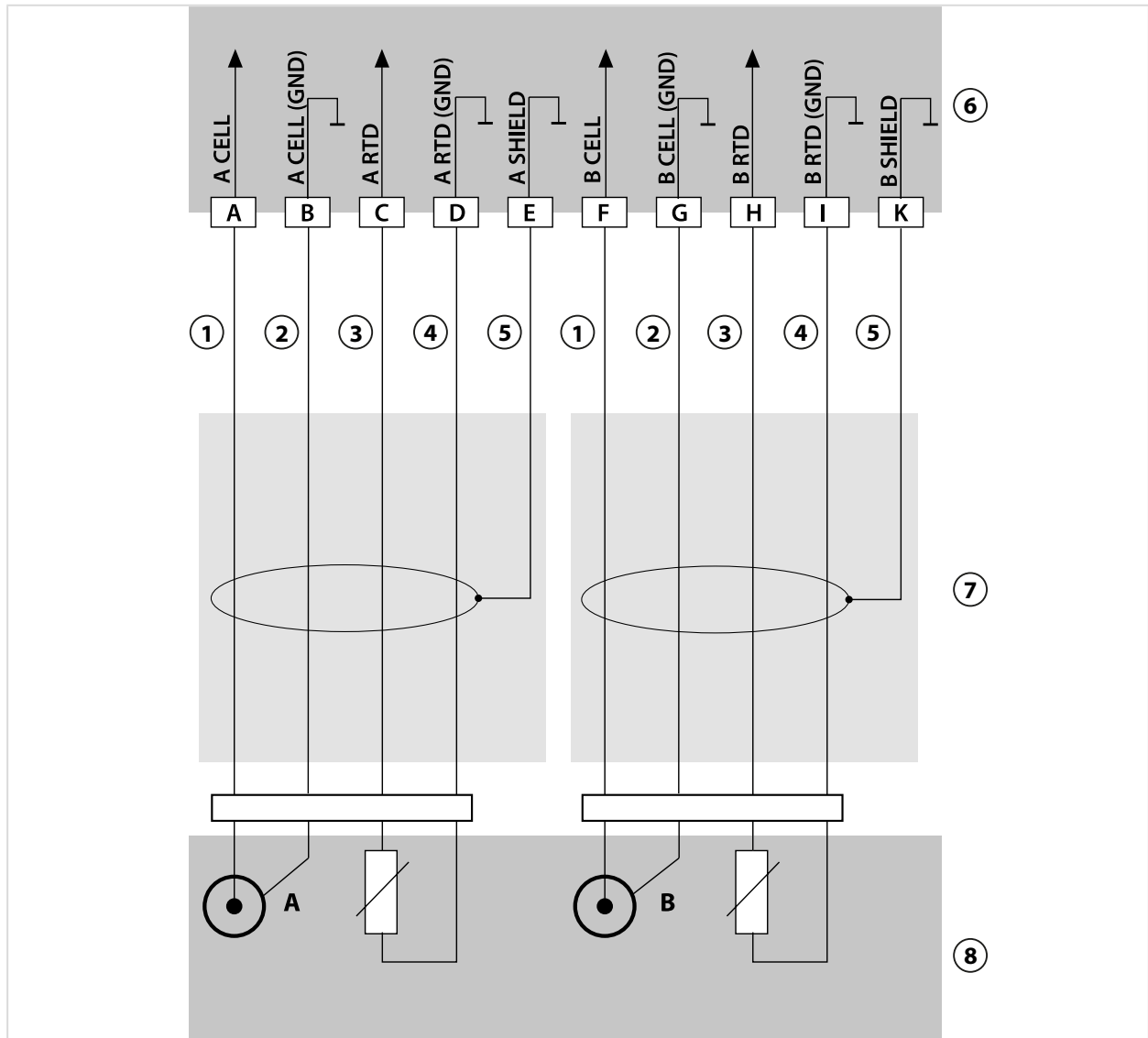

1 White	5 Black
2 Brown	6 Module MK-CC065N
3 Yellow	7 2x cable
4 Green	8 Sensors

16.1.7 Oxygen Wiring Examples

Standard Oxygen Wiring Example

Measurement task:	Oxygen (standard, amperometric)
Sensors (example):	e.g., SE706
Cable (example):	CA/VP6ST-003A (ZU0313)

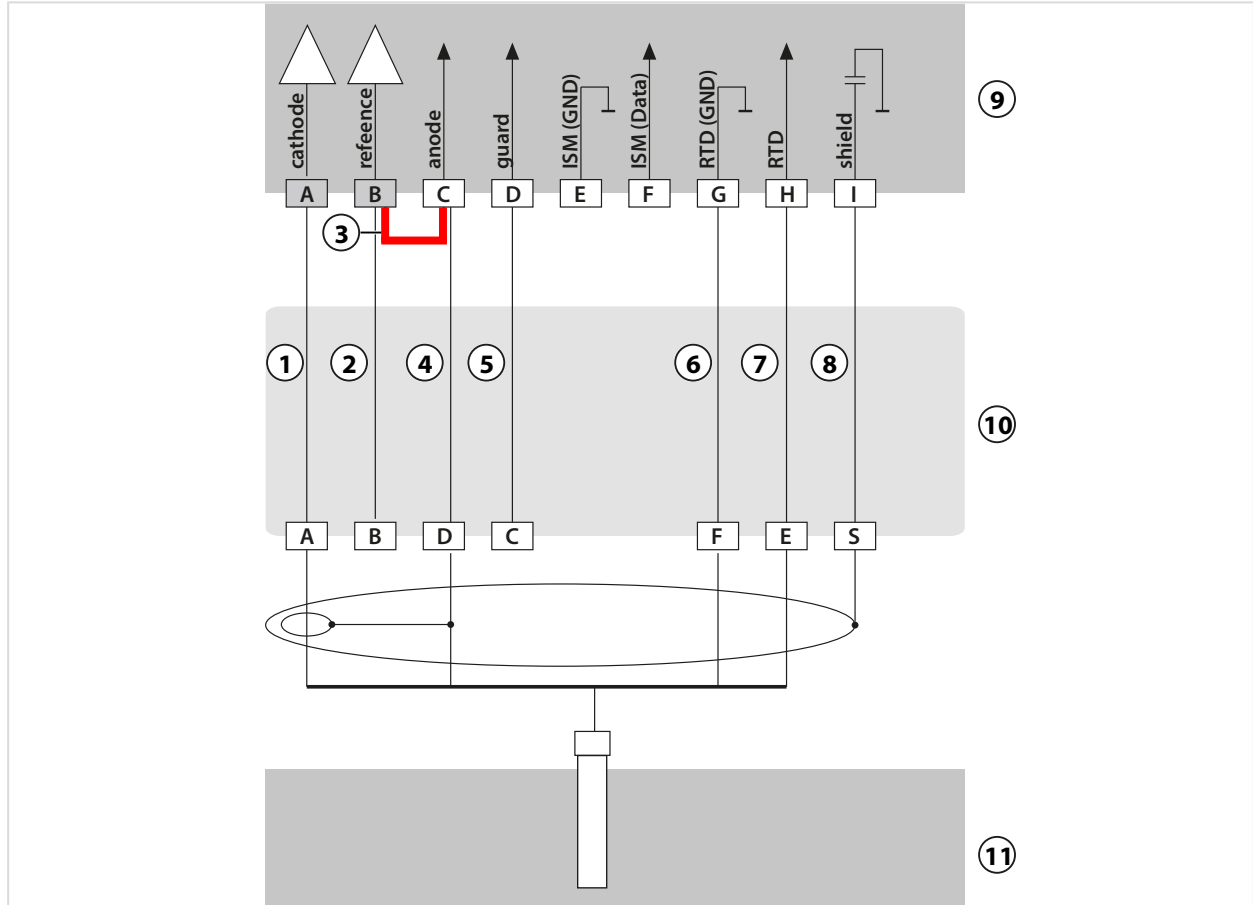

1 Core	5 Gray
2 Blue	6 Green
3 Jumper!	7 White
4 Shield	8 Outer shield

Trace Oxygen Measurement Wiring Example

Measurement task:	Trace oxygen measurement, TAN option FW-E015
Sensors (example):	Type "01" (e.g., SE707)
Cable (example):	CA/VP6ST-003A (ZU0313)

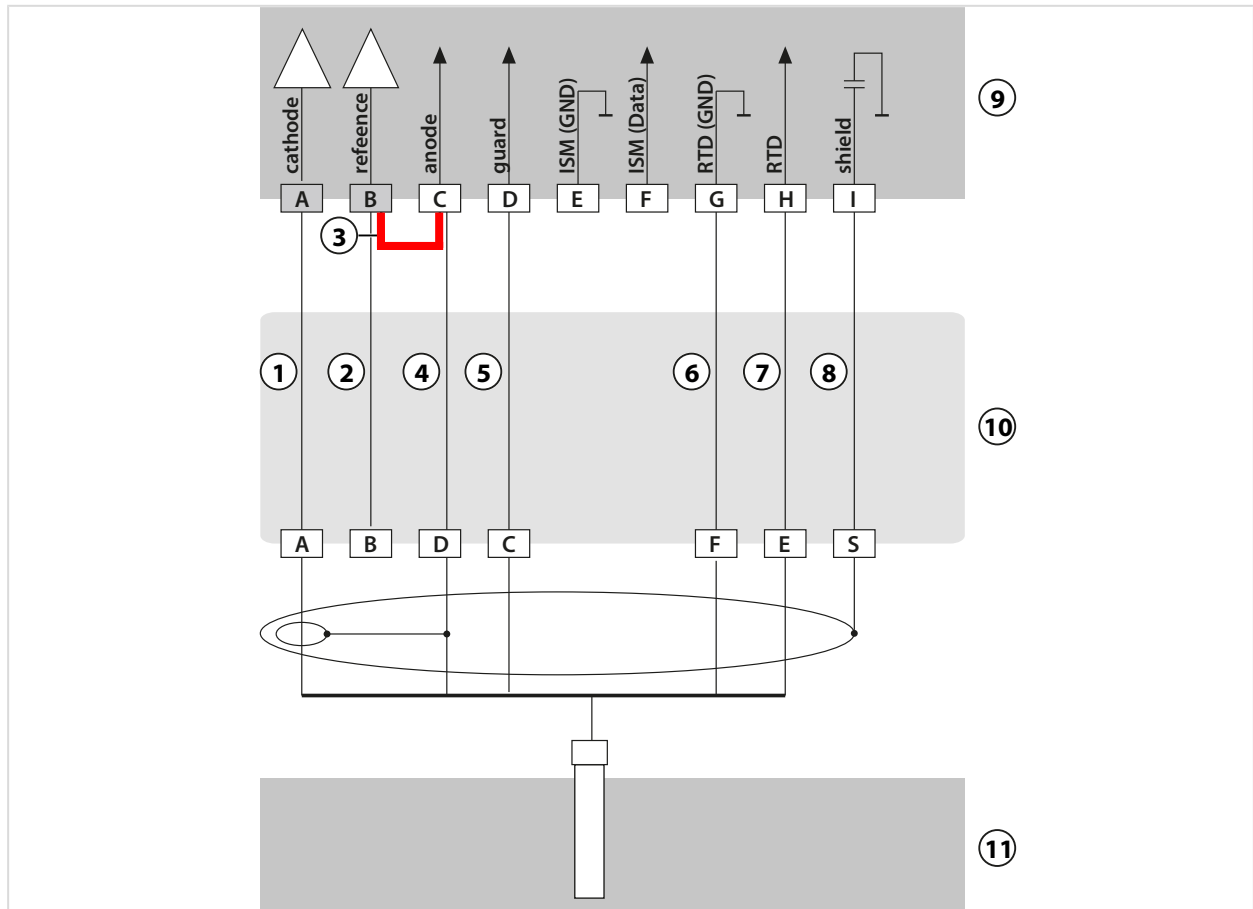

1 Core	5 Gray
2 Blue	6 Green
3 Jumper!	7 White
4 Shield	8 Outer shield

ISM Oxygen Wiring Example





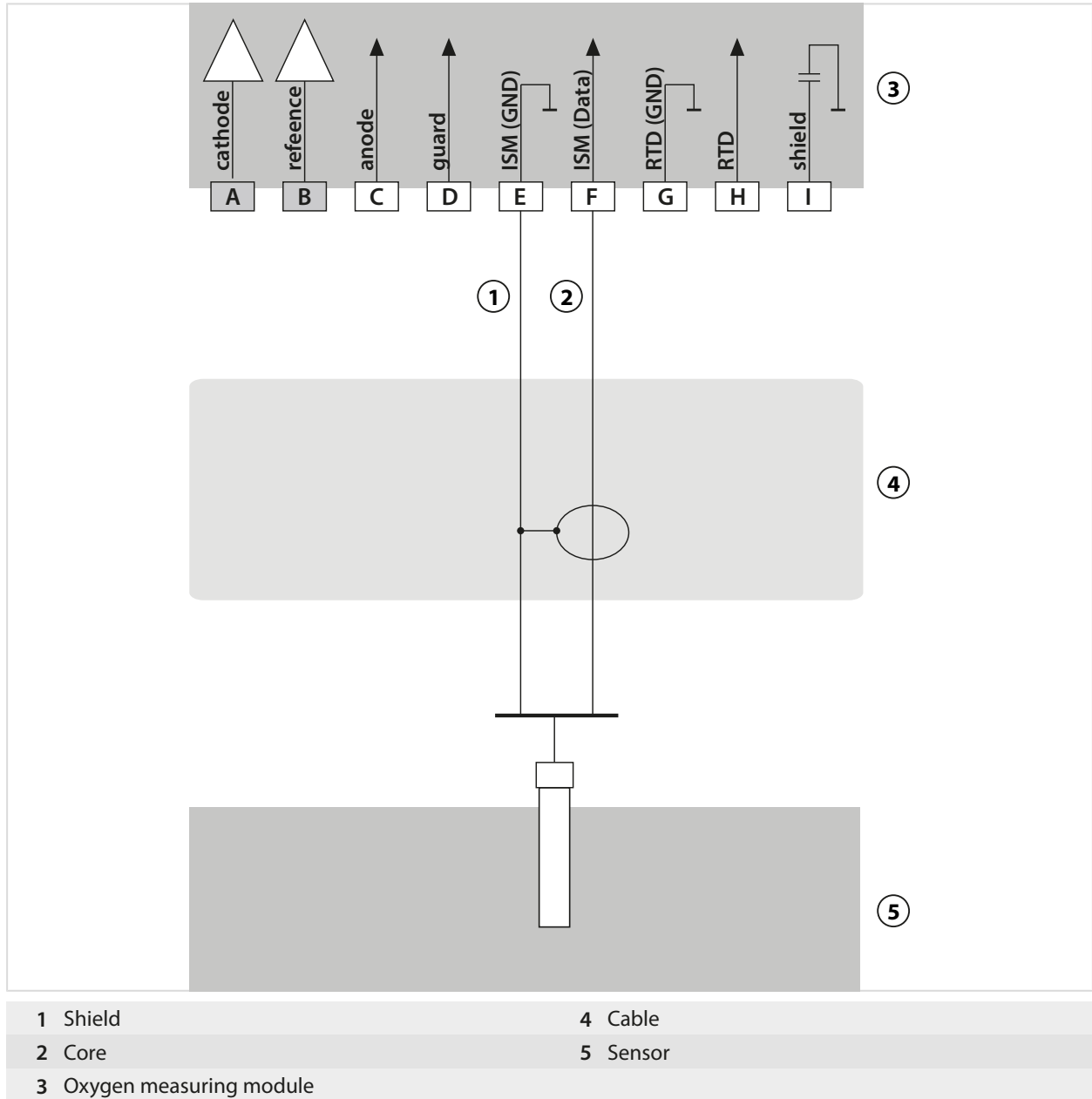







Channel II, requires TAN option FW-E053 "Digital ISM sensors"

Measurement task:	Oxygen (standard, amperometric)
Sensors (example):	InPro 6850i (Mettler-Toledo)
Cable (example):	AK9 (Mettler-Toledo)



16.2 Symbols and Markings on the Display

	<p>Function check in accordance with NAMUR NE 107 <i>Wrench icon on orange background</i> The "HOLD" NAMUR contact is active. Current outputs as configured: Currently measured value: The currently measured value appears at the current output. Last measured value: The last measured value is held at the current output. Fixed value: The current output supplies a fixed value.</p>
	<p>Out of specification in accordance with NAMUR NE 107 <i>Black question mark icon on yellow background</i> The "Out of Specification" NAMUR contact is active. Error message: Diagnostics ▶ Message List</p>
	<p>Failure in accordance with NAMUR NE 107 <i>Flashing black cross icon on red background</i> The "Failure" NAMUR contact is active. Error message: Diagnostics ▶ Message List</p>
	<p>Maintenance required in accordance with NAMUR NE 107 <i>Oil can symbol on blue background</i> The NAMUR "Maintenance Required" contact is active. Error message: Diagnostics ▶ Message List</p>
	<p>Indication of module and network status → <i>Local Operation, p. 105</i></p>
	<p>The device is in calibration mode. Function check (HOLD) is active.</p>
	<p>The device is in maintenance mode. Function check (HOLD) is active.</p>
	<p>The device is in parameter mode. Function check (HOLD) is active.</p>
	<p>The device is in diagnostics mode.</p>
	<p>The device is in measuring mode.</p>
	<p>Selectable parameter sets (A/B). Indicates which parameter set is currently active when a control element for parameter set selection was selected: Parameter Setting ▶ System Control ▶ Function Control</p>
	<p>There is a memory card in the device and the device cannot access it. This can be a memory card of the Data Card type that is "closed" for use. If you want to continue using the "closed" Data Card, select "Open Memory Card" in the Maintenance menu.</p>
	<p>There is an enabled Data Card (memory card) in the device. Note: Note: Select "Close Memory Card" in the Maintenance menu before removing the memory card.</p>
	<p>There is an FW Update Card (memory card) in the device. You can save the current device firmware or perform a firmware update from the memory card. Note: Check the parameter settings after updating.</p>
	<p>Firmware repair in case of device malfunctions free of charge. TAN option FW-E106 is not required here. General data cannot be stored on this memory card.</p>

	<p>Designates the measuring channel for clear assignment of measured value/parameter displays in the case of identical process variables. Channel I: Memosens sensor/optical oxygen sensor SE740 (LDO) Channel II: Measuring module for analog sensor or second Memosens sensor</p>
	<p>Channel IIA: First channel in MK-CC module Channel IIB: Second channel in MK-CC module</p>
	<p>Channel CI: Calculation block 1 Channel CII: Calculation block 2</p>
	<p>To the left of a menu line that contains a further menu level. Pressing <i>enter</i> opens the submenu.</p>
	<p>To the left of a menu line that, at administrator level, can be blocked from access at operator level.</p>
	<p>To the left of a menu line that, at administrator level, was blocked from access at operator level.</p>
	<p>When in measuring mode, Sensoface smileys indicate the quality of the sensor data: Happy</p>
	<p>Neutral</p>
	<p>Sad</p>
	<p>Waiting time; device is busy.</p>
	<p>Product calibration was not completed. The lab value still needs to be entered.</p>
	<p>To the left of a Diagnostics menu item set as a "Favorite".</p>
	<p>Context menu: Open with <i>right softkey</i>.</p>

17 Abbreviations

A/F	Width across flats
AI	Analog input
AO	Analog output
CAT	Category
CIP	Cleaning in place
CIP	EtherNet/IP: Common Industrial Product
DHCP	Dynamic host configuration protocol
DIN	Deutsches Institut für Normung (German Institute for Standardization)
DO	Digital output
EDS	Electronic data sheet
EEPROM	Electrically Erasable Programmable Read-only Memory
EIP	EtherNet/IP
EMC	Electromagnetic compatibility
EN	European standard
ESD	Electrostatic discharge
FW	Firmware
IEC	International Electrotechnical Commission
IP	International Protection/Ingress Protection
IPv4	Internet protocol version 4
ISFET	Ion-sensitive field-effect transistor
ISM	Intelligent sensor management
LDO	Luminescent dissolved oxygen
MAC	Media access control
MS	Module status
MSL	Mean Sea Level
NAMUR	User Association of Automation Technology in Process Industries
NE 107	NAMUR recommendation 107: "Monitoring and Diagnosis of Field Devices"
NEMA	National Electrical Manufacturers Association, USA
NIST	National Institute of Standards and Technology, USA
NS	Network status
NTC	Negative temperature coefficient
PELV	Protective extra low voltage
RAM	Random-access memory
RD	Received data
RJ45	Registered jack
RoHS	Restriction of Hazardous Substances
SELV	Safety extra low voltage
SIP	Sterilization in place
TAN	Transaction number
TC	Temperature compensation/coefficient
TD	Transmitted data
TDS	Total dissolved solids
TFT	Thin film transistor
USP	U.S. Pharmacopeia



Knick
Elektronische Messgeräte
GmbH & Co. KG

Beuckestraße 22
14163 Berlin
Germany
Phone: +49 30 80191-0
Fax: +49 30 80191-200
info@knick.de
www.knick-international.com

Translation of the original instructions
Copyright 2024 • Subject to change
Version 3 • This document was published on December 13, 2024.
The latest documents are available for download on our
website under the corresponding product description.

TA-212.512-KNEN03



103762